



US00D978023S

(12) **United States Design Patent**
Liu et al.

(10) **Patent No.:** **US D978,023 S**
(45) **Date of Patent:** **** Feb. 14, 2023**

(54) **AUTOMOBILE**

(71) Applicant: **JIANGSU NIUTRON TECHNOLOGY CO., LTD.**,
Changzhou (CN)

(72) Inventors: **Chuan-kai Liu**, Jiangsu (CN); **Dongye Zhou**, Jiangsu (CN); **Shawn Kim**, Jiangsu (CN); **Haifeng Zhang**, Jiangsu (CN); **Xiaohui Shao**, Jiangsu (CN)

(**) Term: **15 Years**

(21) Appl. No.: **35/514,813**

(22) Filed: **May 18, 2022**

(80) **Hague Agreement Data**

Int. Filing Date: **May 18, 2022**
Int. Reg. No.: **DM/222137**
Int. Reg. Date: **May 18, 2022**
Int. Reg. Pub. Date: **Jul. 29, 2022**

(51) **LOC (14) Cl.** **12-08**

(52) **U.S. Cl.**
USPC **D12/91**

(58) **Field of Classification Search**
USPC D12/82, 86, 90-92; D21/424, 433, 434, D21/533, 548-550
CPC B62D 25/00; B62D 25/06; B62D 33/00; B62D 35/00; B62D 47/00; B62D 31/00; B62D 31/003

See application file for complete search history.

(56) **References Cited**

U.S. PATENT DOCUMENTS

D418,086 S * 12/1999 Starr D12/91
D718,188 S * 11/2014 Wheel D12/91
D750,532 S * 3/2016 Frascella D12/91
D791,645 S * 7/2017 Henstridge D12/91
D849,600 S * 5/2019 Egan D12/91
D942,328 S * 2/2022 Battams D12/91

D957,997 S * 7/2022 Wheel D12/91
D957,998 S * 7/2022 Wheel D12/91
D961,453 S * 8/2022 Park D12/91
D965,472 S * 10/2022 Cartia D12/91
D969,024 S * 11/2022 Arguden D12/91

* cited by examiner

Primary Examiner — Joseph Kukella

(57) **CLAIM**

The ornamental design for an automobile, as shown and described.

DESCRIPTION

1. Automobile

2. Automobile

FIG. 1.1 is a front right side perspective view of an automobile according to a first embodiment of the present design;

FIG. 1.2 is a rear left side perspective view of an automobile according to a first embodiment of the present design;

FIG. 1.3 is a front view thereof;

FIG. 1.4 is a rear view thereof;

FIG. 1.5 is a left side view thereof;

FIG. 1.6 is a right side view thereof;

FIG. 1.7 is a top view thereof;

FIG. 2.1 is a front right side perspective view of an automobile according to a second embodiment of the present design;

FIG. 2.2 is a rear left side perspective view of an automobile according to a second embodiment of the present design;

FIG. 2.3 is a front view thereof;

FIG. 2.4 is a rear view thereof;

FIG. 2.5 is a left side view thereof;

FIG. 2.6 is a right side view thereof; and

FIG. 2.7 is a top view thereof.

The bottom view of the automobile according to each of the first and second embodiments of the present design is omitted since the bottom of the automobile is invisible in use.

1 Claim, 14 Drawing Sheets

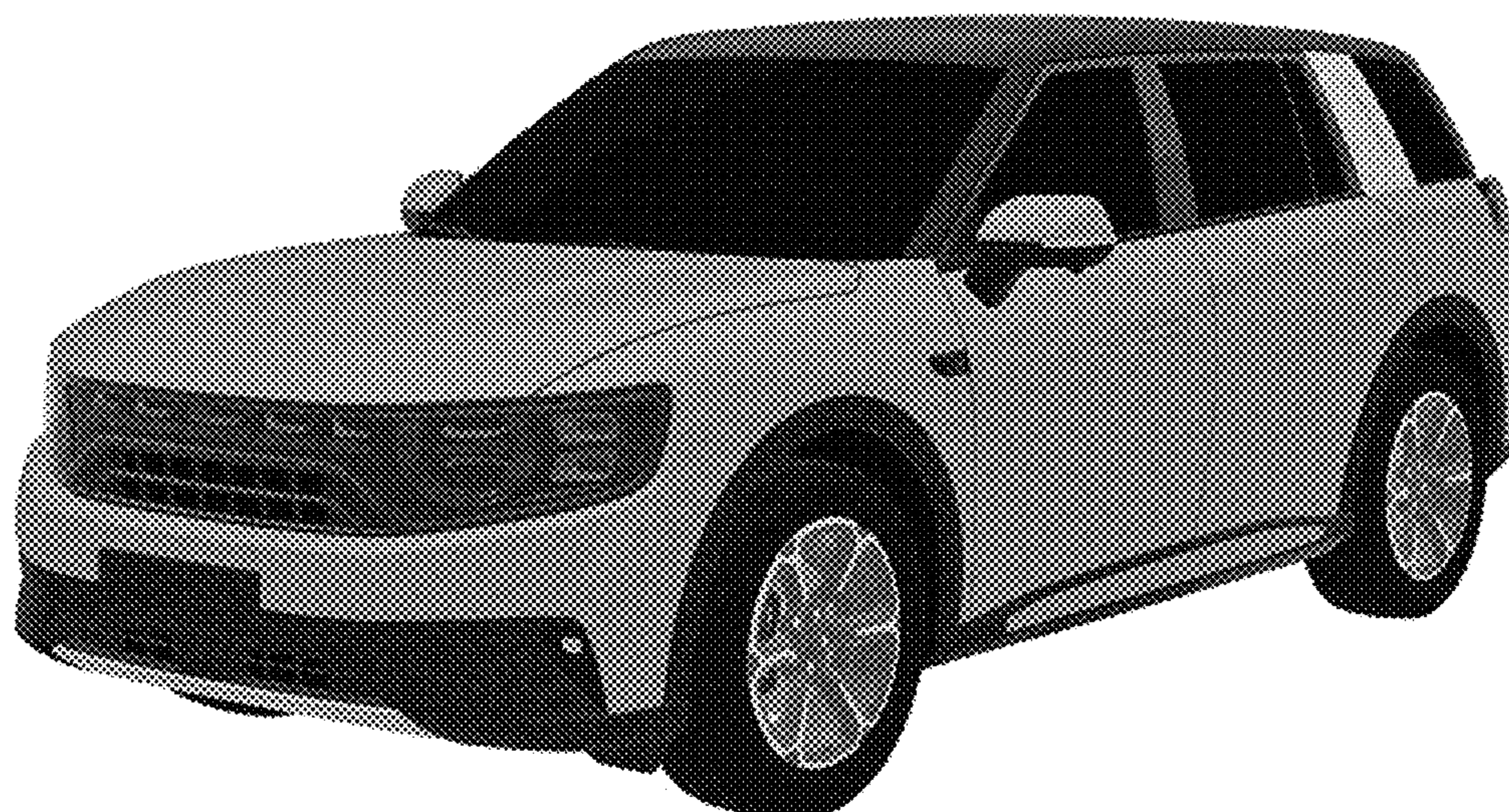

1.1

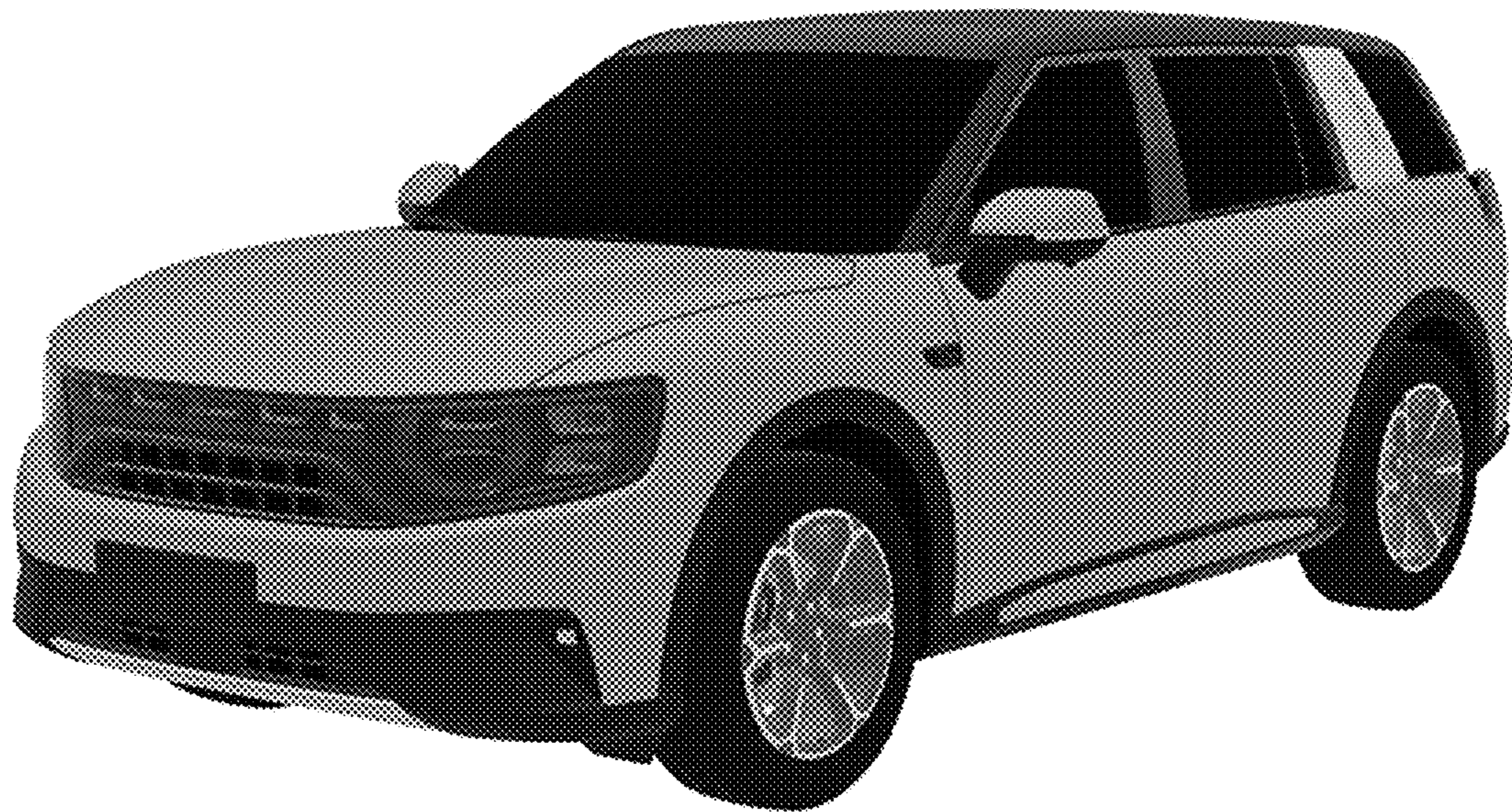

1.2

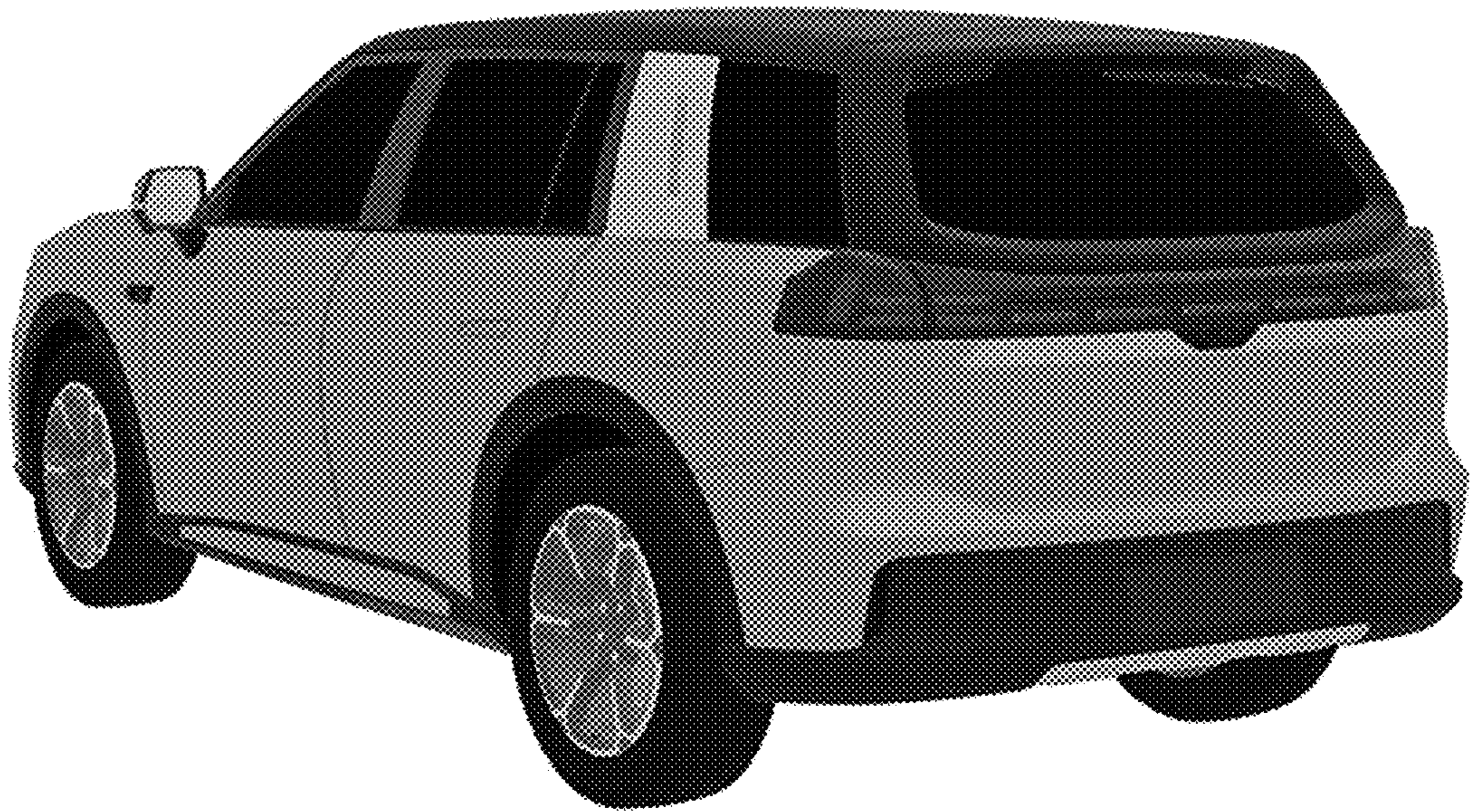

1.3

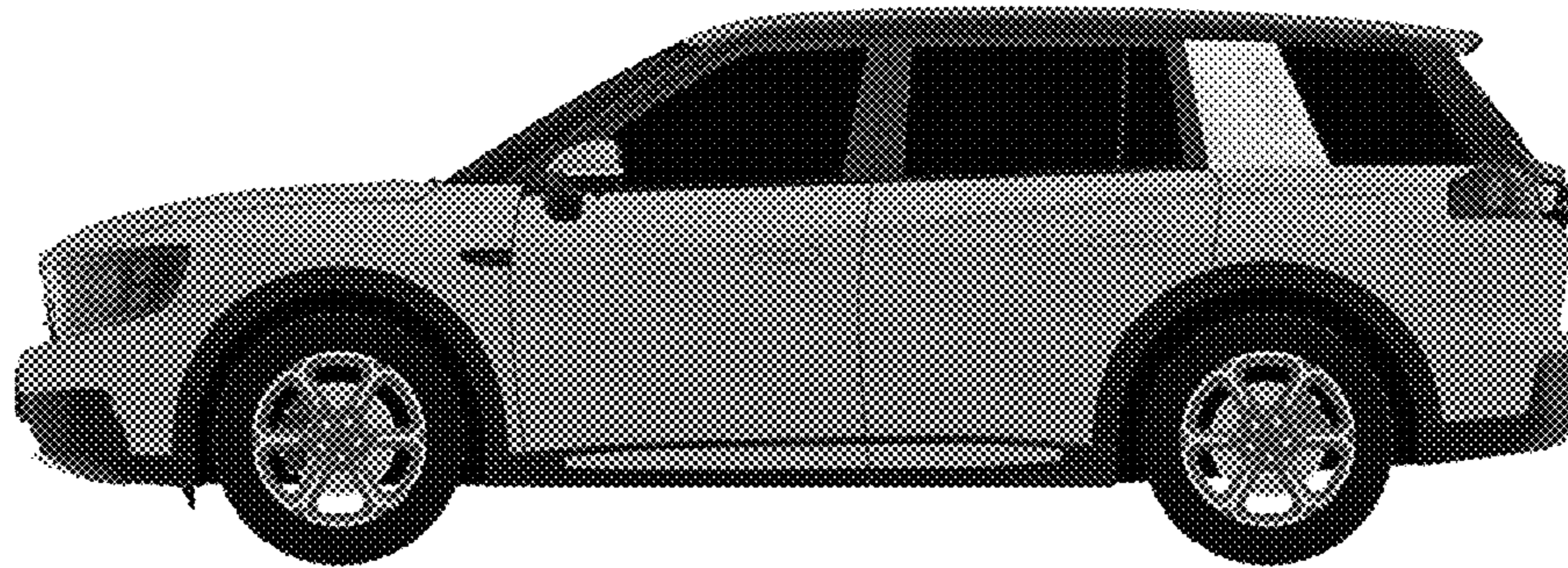

1.4

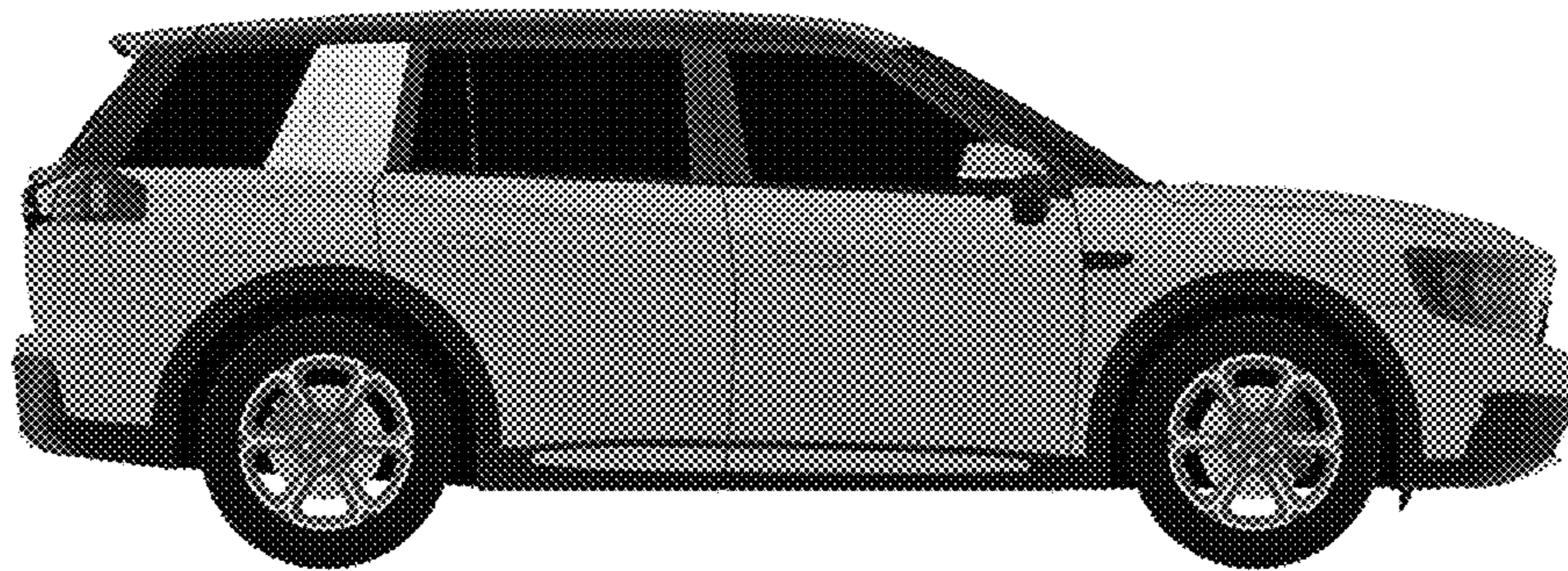

1.5

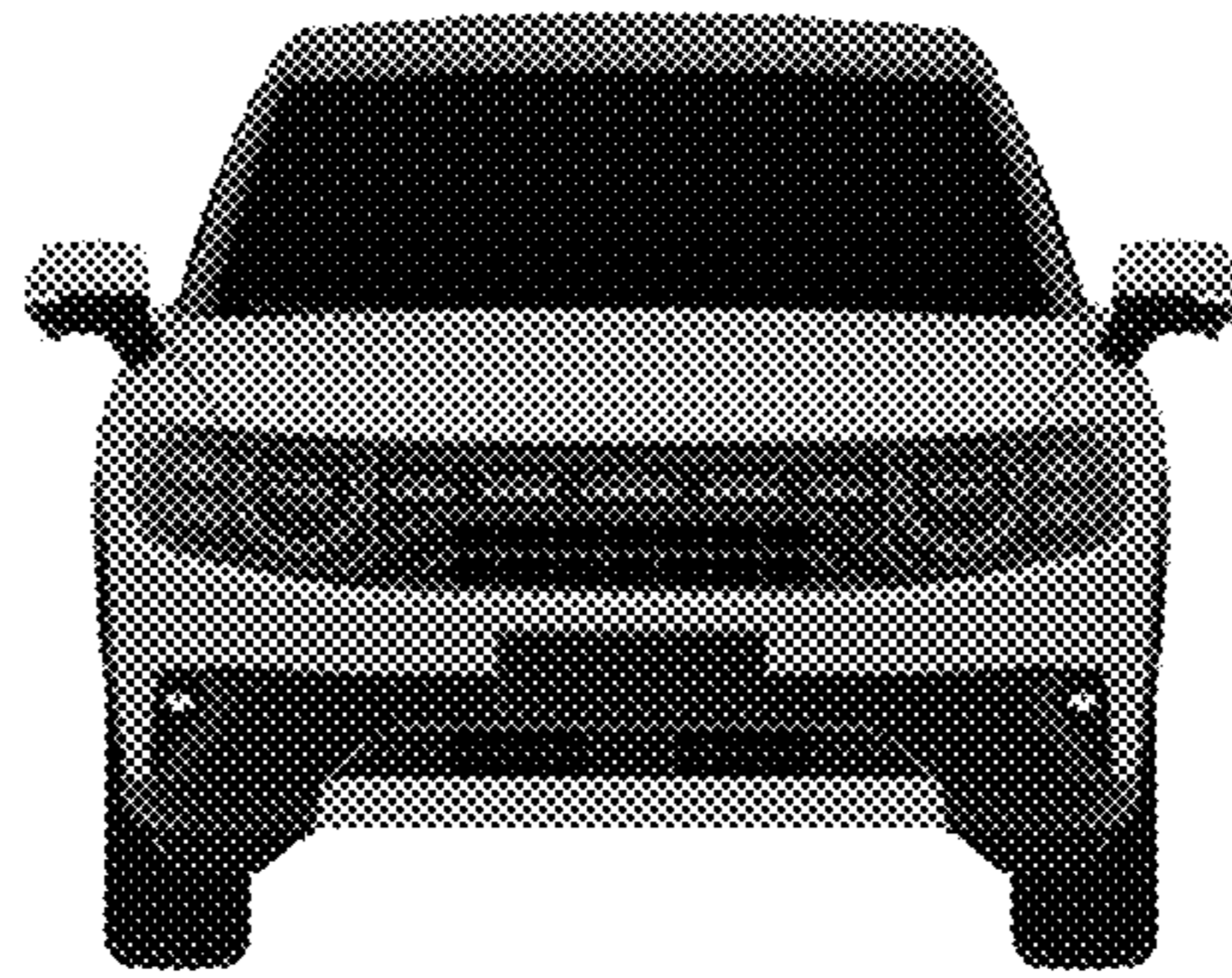

1.6

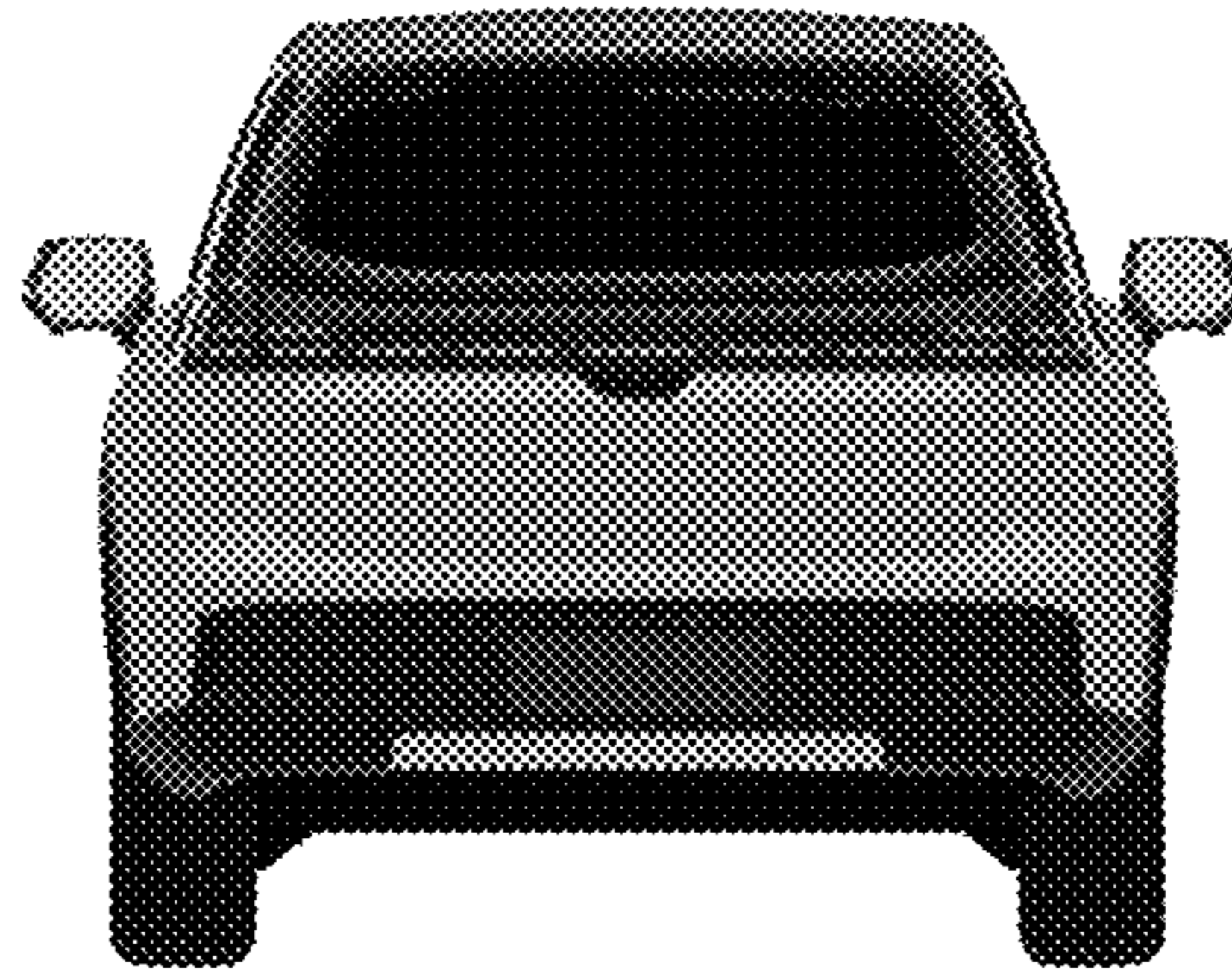

1.7

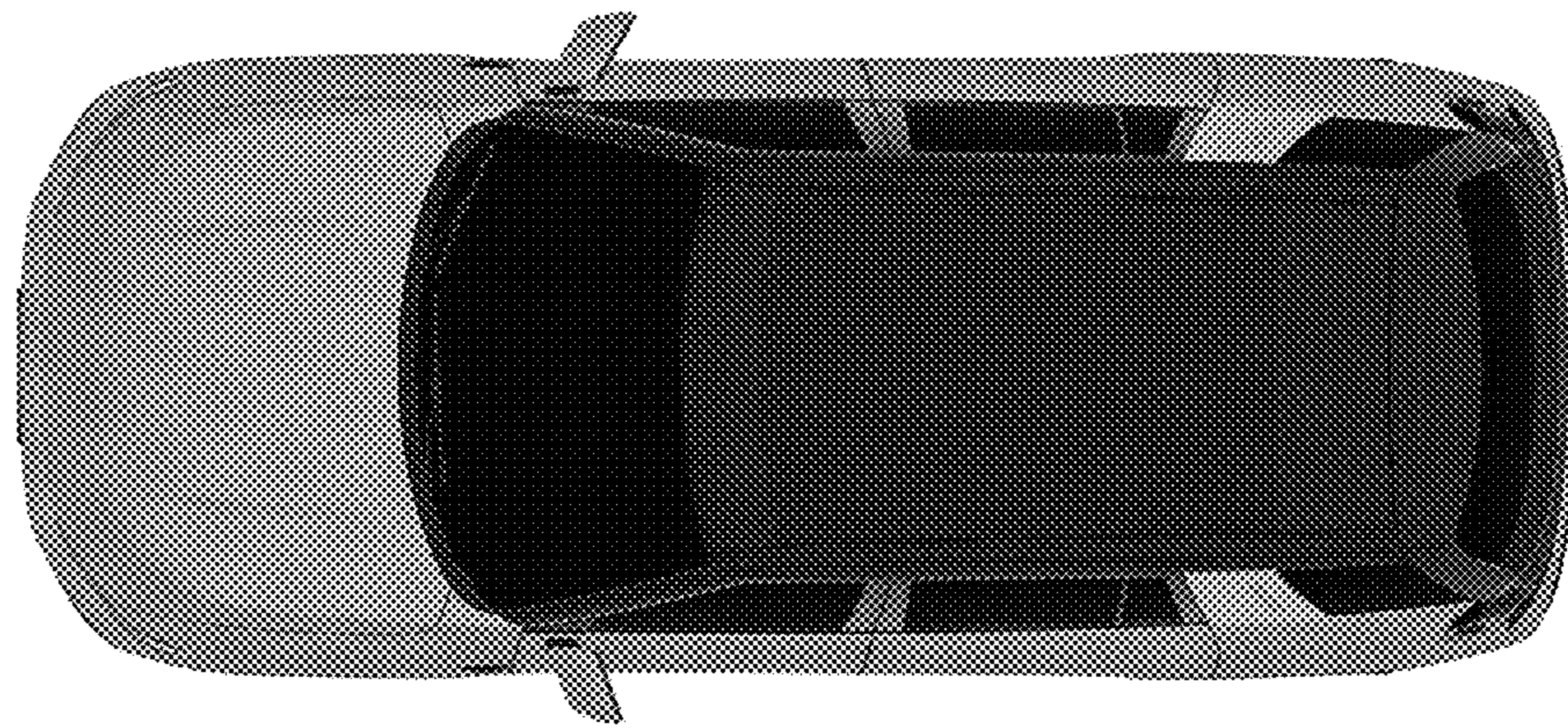

2.1



2.2

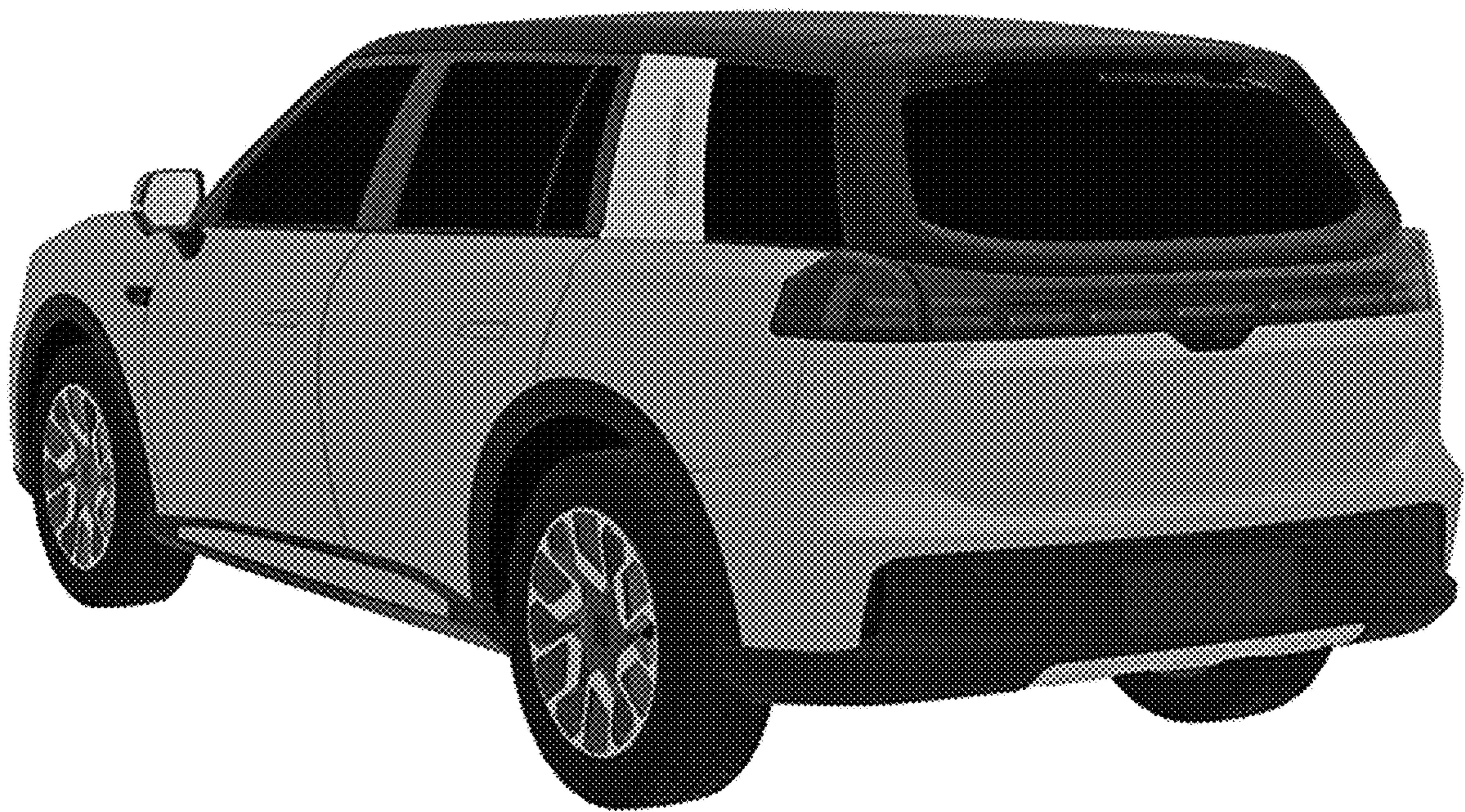

2.3

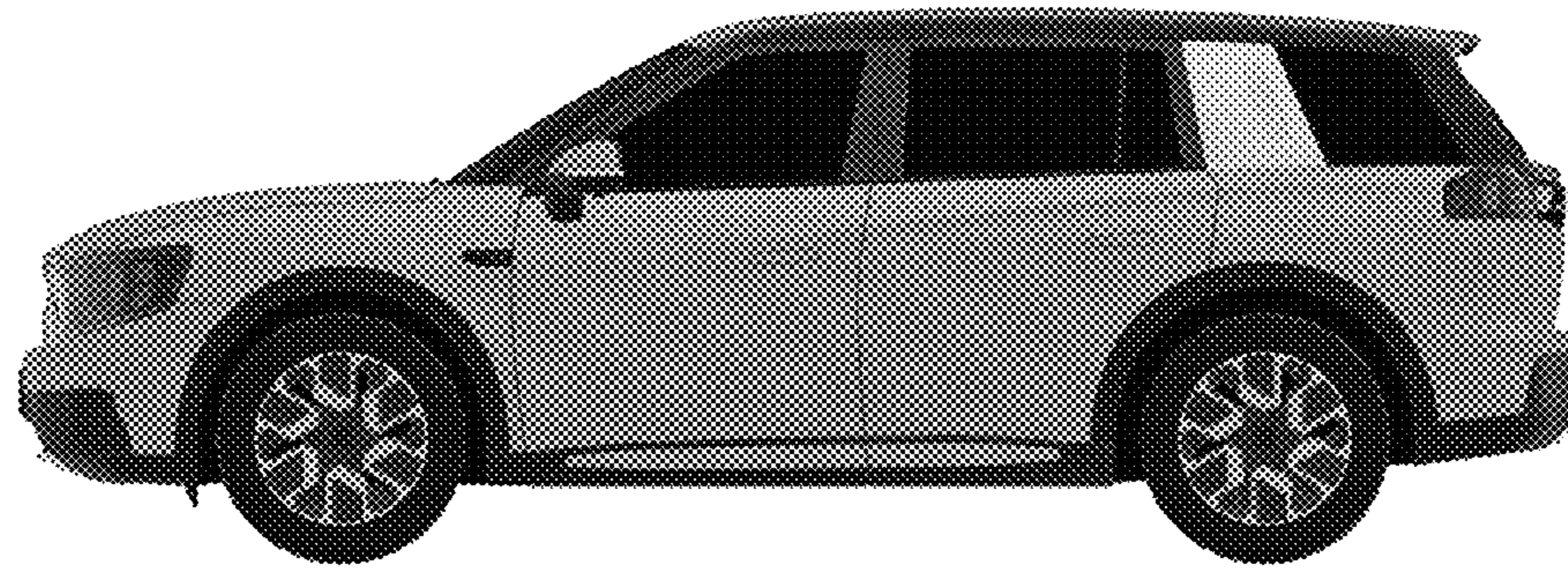

2.4

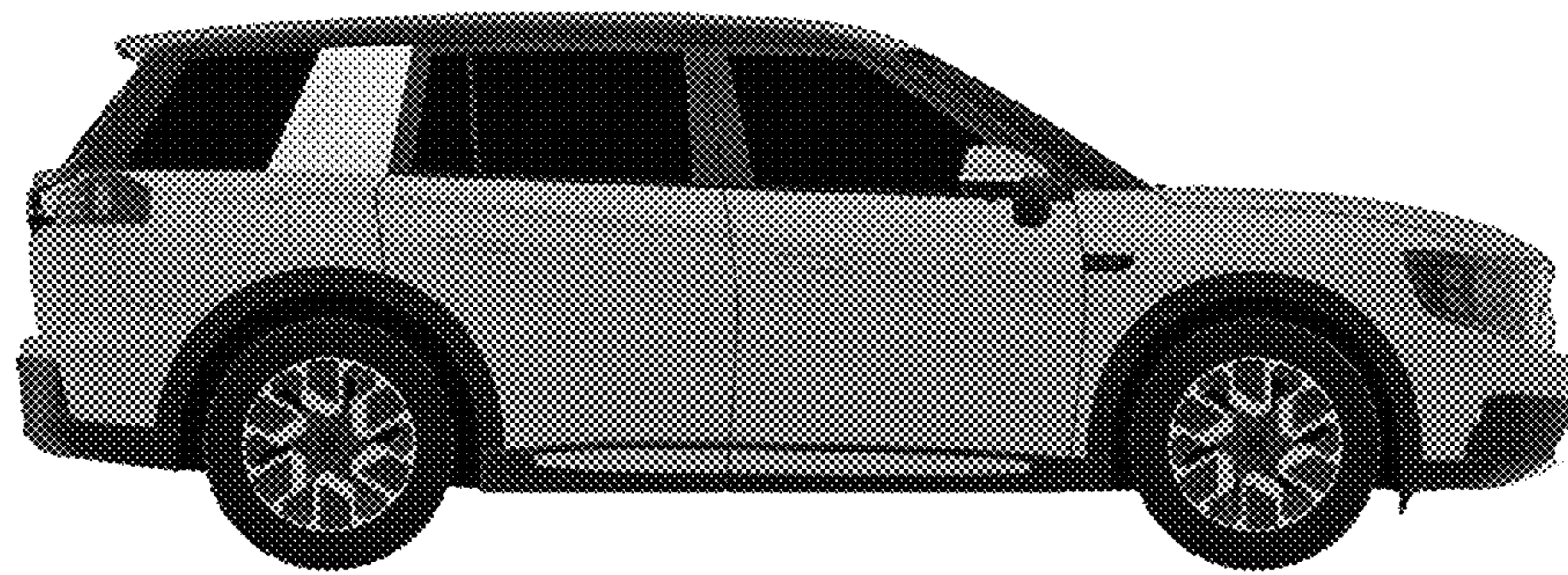

2.5

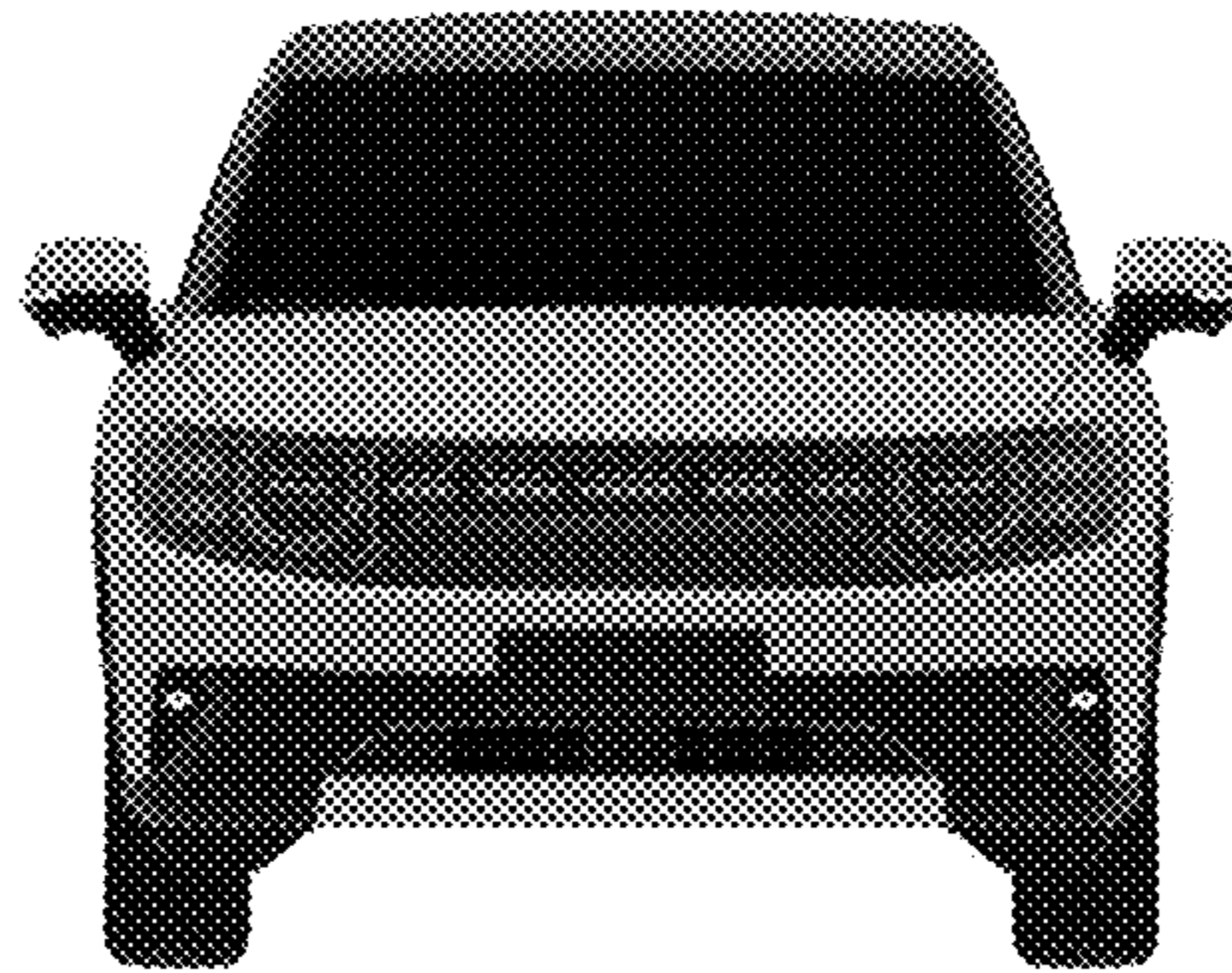

2.6

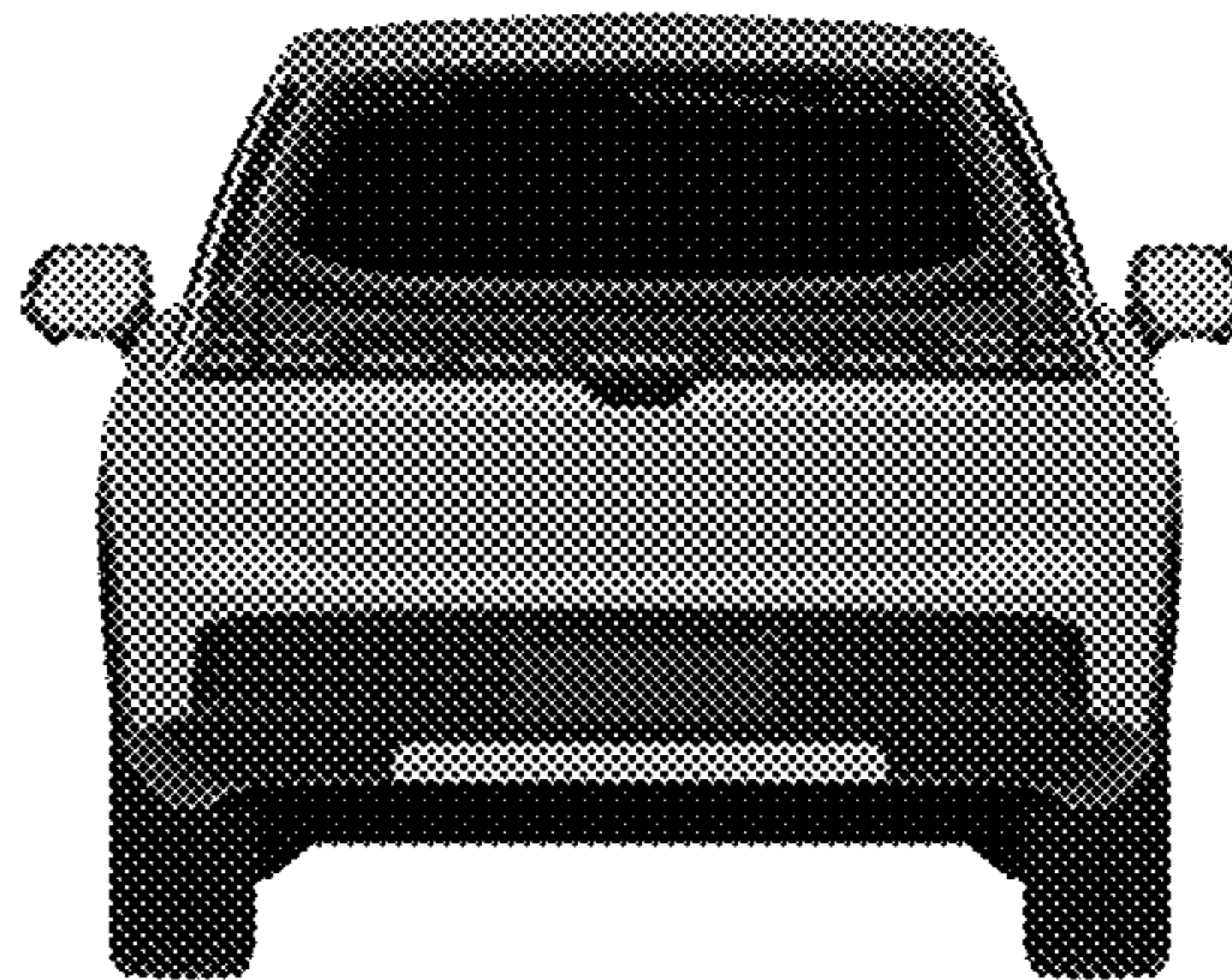

2.7

