



US00D978018S

(12) **United States Design Patent** (10) **Patent No.:** **US D978,018 S**  
**Chung et al.** (45) **Date of Patent:** **\*\* Feb. 14, 2023**

- (54) **PLANT CULTIVATION DEVICE**
- (71) Applicant: **SAMSUNG ELECTRONICS CO., LTD.**, Suwon-si (KR)
- (72) Inventors: **Jinman Chung**, Suwon-si (KR); **Jieun Kim**, Suwon-si (KR); **Sohmin Ahn**, Suwon-si (KR)
- (73) Assignee: **Samsung Electronics Co., Ltd.**, Suwon-si (KR)
- (\*\*) Term: **15 Years**
- (21) Appl. No.: **29/780,879**
- (22) Filed: **Apr. 27, 2021**
- (30) **Foreign Application Priority Data**
- Oct. 29, 2020 (KR) ..... 30-2020-0051799
- (51) **LOC (14) Cl.** ..... **11-02**
- (52) **U.S. Cl.**  
USPC ..... **D11/155**
- (58) **Field of Classification Search**  
USPC ..... D11/143–156, 164; D6/403–405, D6/556–558; D26/9, 10; D15/79–91  
CPC . A01G 9/00; A01G 9/02; A01G 9/021; A01G 9/04; A01G 9/022; A01G 9/029; A01G 9/0293; A01G 9/042; A01G 27/003; A01G 31/02; A01G 31/06; A01G 7/00; A01G 7/02; A01G 7/06; A01G 7/08  
See application file for complete search history.

- (56) **References Cited**
- U.S. PATENT DOCUMENTS
- D226,647 S \* 4/1973 Longato ..... D6/675.1  
D234,530 S \* 3/1975 Waltzman ..... D11/155  
D236,633 S \* 9/1975 Shalom ..... D30/101  
D641,657 S \* 7/2011 Wardenburg ..... D11/155

- D642,492 S \* 8/2011 Wardenburg ..... D11/155  
D659,724 S \* 5/2012 Wolfe ..... D15/79  
D659,725 S \* 5/2012 Wolfe ..... D15/85  
D667,174 S \* 9/2012 Stevenson ..... D30/101  
D788,185 S \* 5/2017 Wolfe ..... D15/79  
D852,090 S \* 6/2019 Bowerman ..... D11/155  
D860,854 S \* 9/2019 Mehmetalioglu ..... D11/145  
D899,299 S \* 10/2020 Craig ..... D11/155  
D912,707 S \* 3/2021 Choi ..... D15/81  
D913,344 S \* 3/2021 Choi ..... D15/79  
D913,842 S \* 3/2021 Vega ..... D11/155  
D924,724 S \* 7/2021 Li ..... D11/155  
D926,627 S \* 8/2021 Craig ..... D11/155  
D959,325 S \* 8/2022 Kim ..... D11/155  
D959,326 S \* 8/2022 Kim ..... D11/155  
D961,450 S \* 8/2022 Kim ..... D11/155  
2003/0005626 A1 \* 1/2003 Yoneda ..... A01G 9/246  
47/69  
2017/0215350 A1 \* 8/2017 Chen ..... A01G 24/20  
(Continued)

*Primary Examiner* — Mark A Goodwin  
(74) *Attorney, Agent, or Firm* — NSIP Law

(57) **CLAIM**

We claim the ornamental design for a plant cultivation device, as shown and described.

**DESCRIPTION**

FIG. 1 is a front perspective view of a plant cultivation device showing our new design;  
FIG. 2 is a front view thereof;  
FIG. 3 is a rear view thereof;  
FIG. 4 is a left-side view thereof;  
FIG. 5 is a right-side view thereof;  
FIG. 6 is a top view thereof;  
FIG. 7 is a bottom view thereof; and,  
FIG. 8 is another front perspective view showing the plant cultivation device in an opened state.  
The broken lines in the figures depict portions of the plant cultivation device that form no part of the claimed design.

**1 Claim, 8 Drawing Sheets**

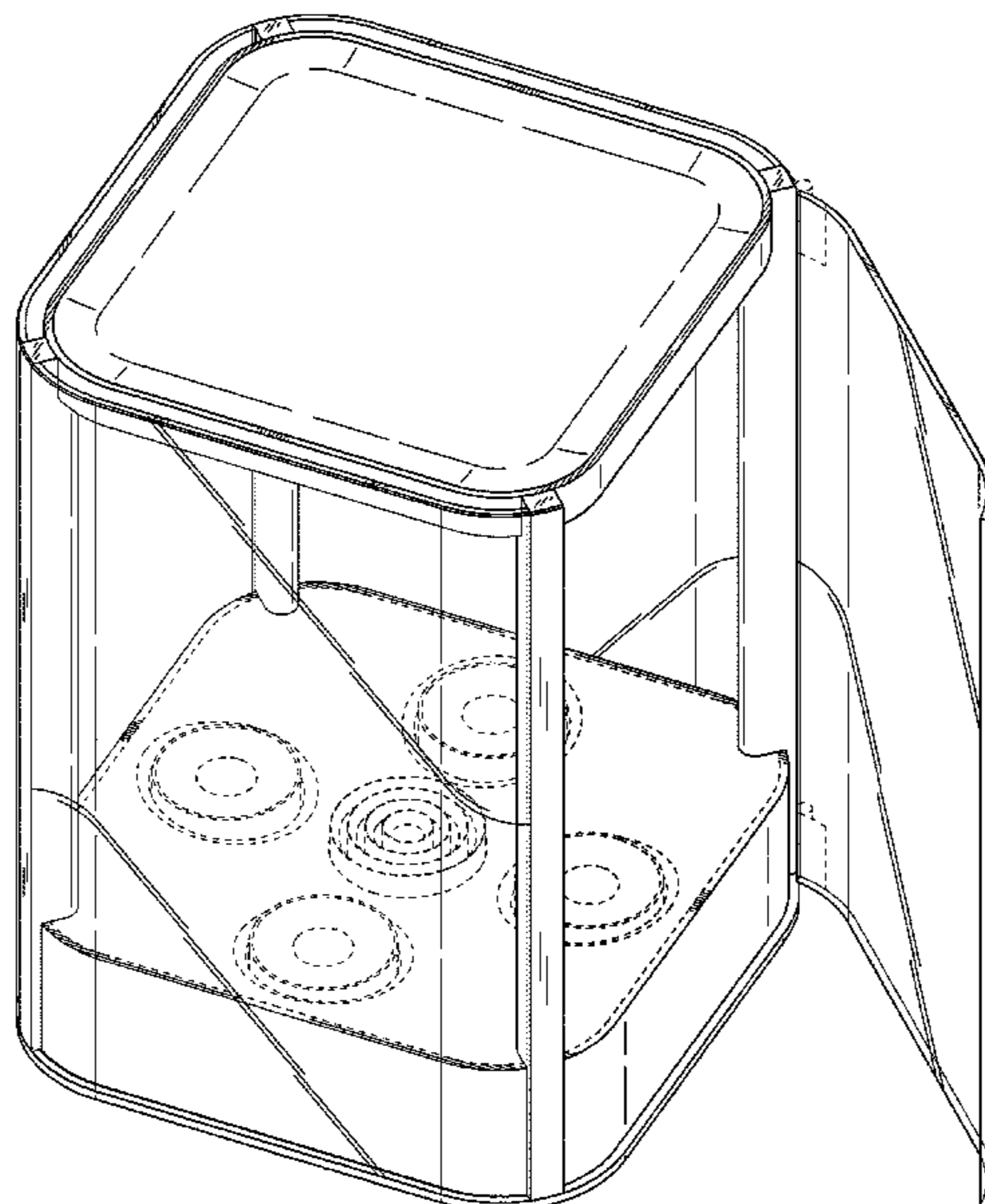

(56)

**References Cited**

U.S. PATENT DOCUMENTS

2019/0327911 A1\* 10/2019 Montagano ..... A01G 9/249  
2022/0192107 A1\* 6/2022 Yoo ..... A01G 31/06

\* cited by examiner

FIG.1

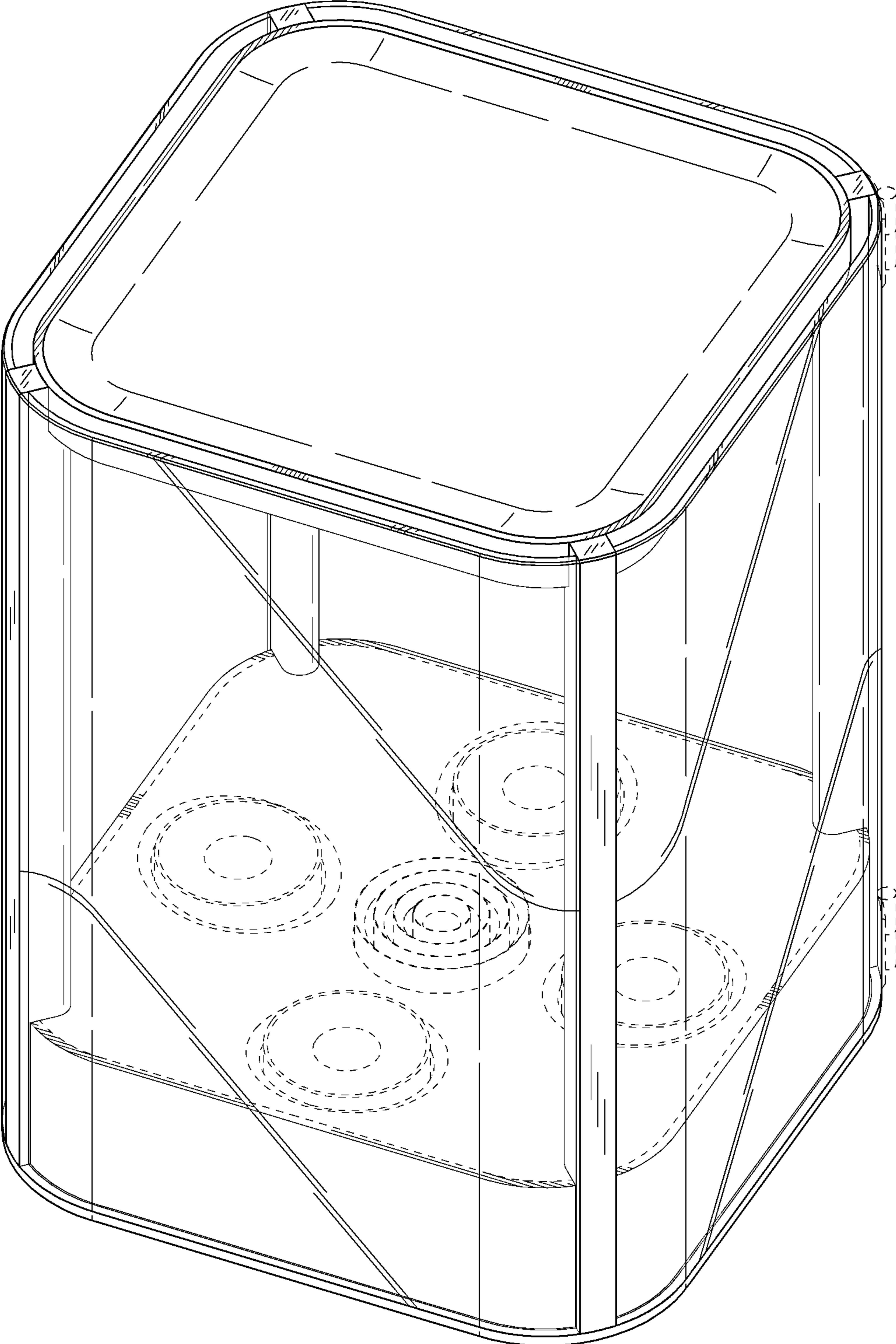

FIG.2

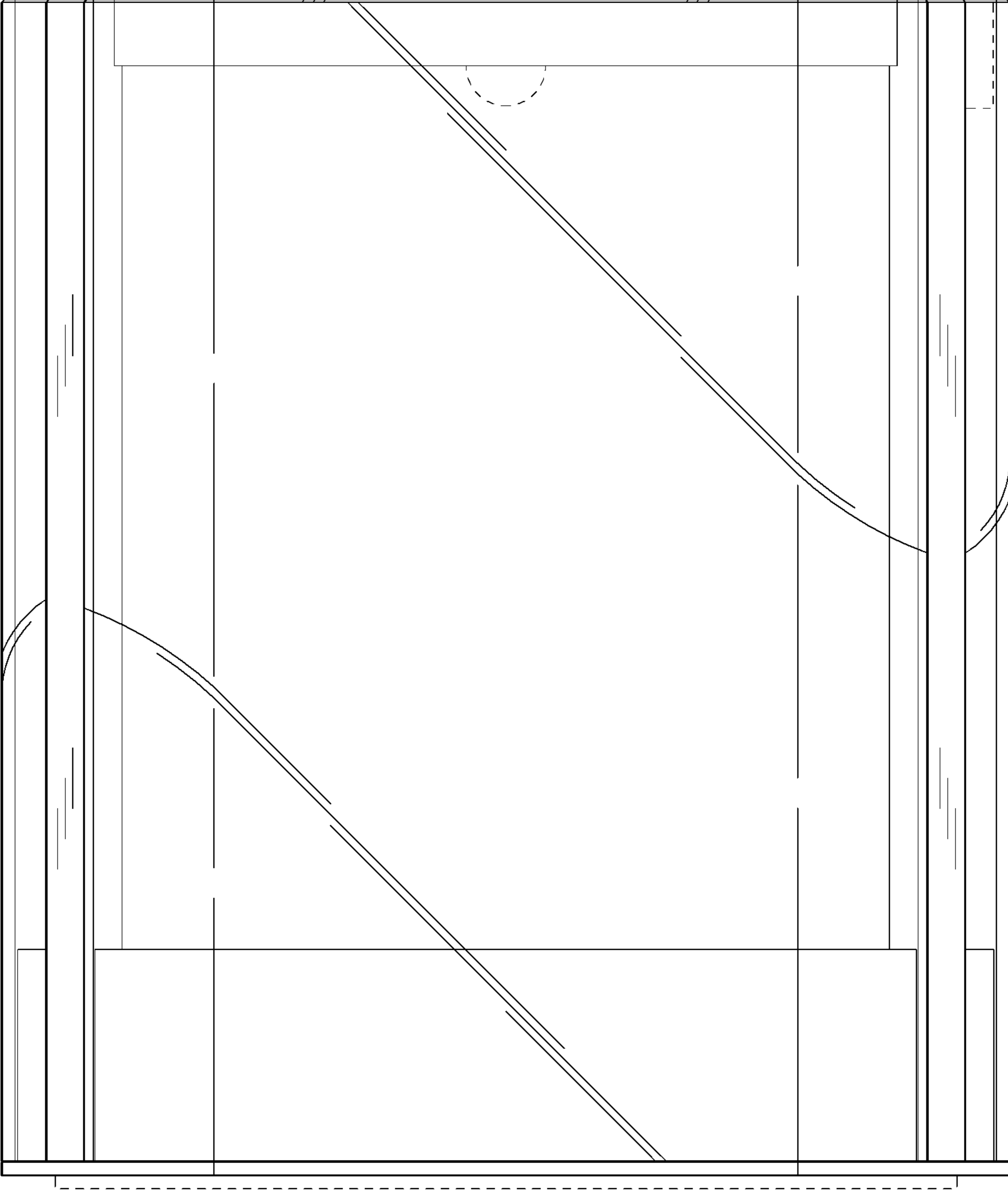

FIG.3

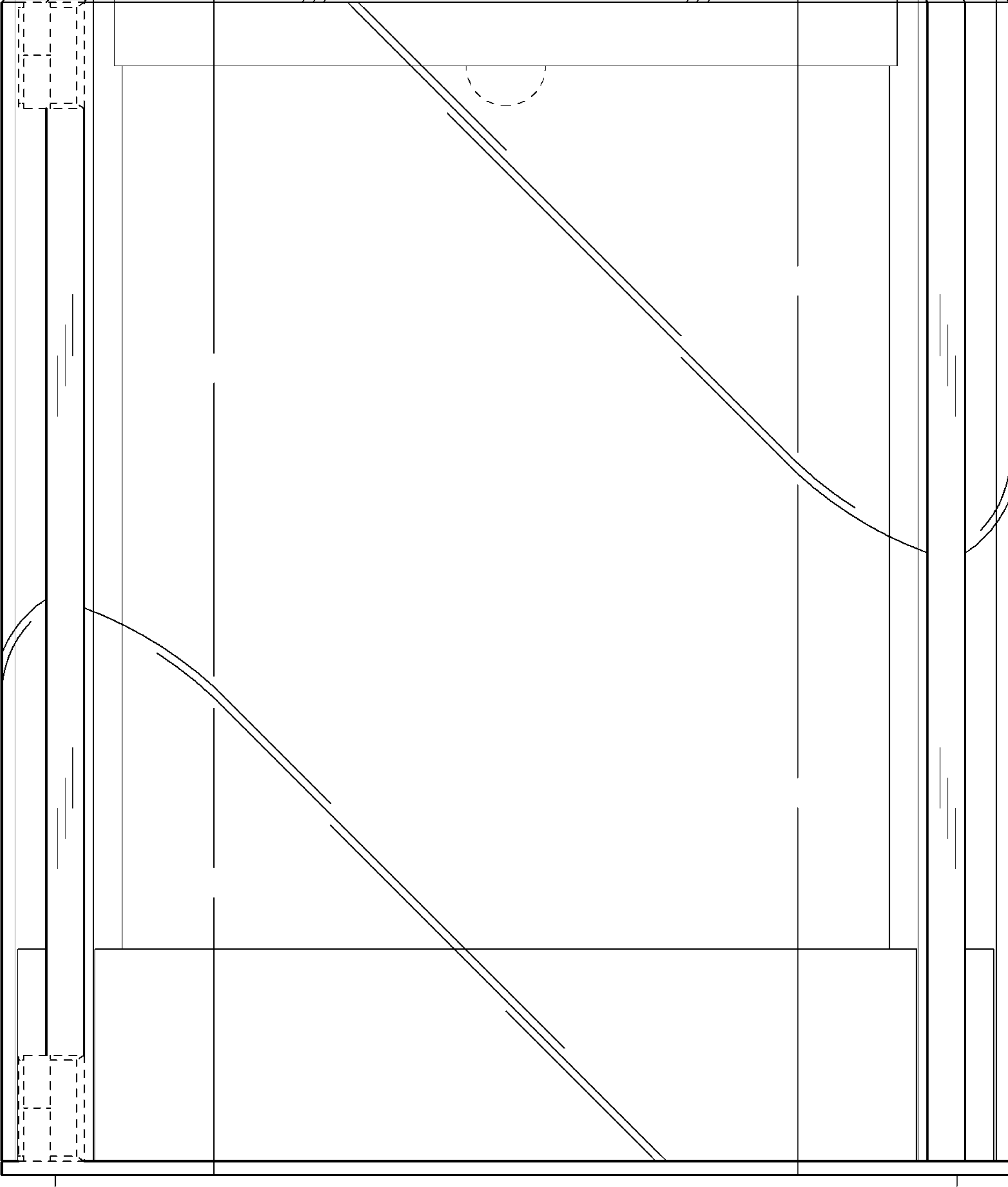

FIG.4

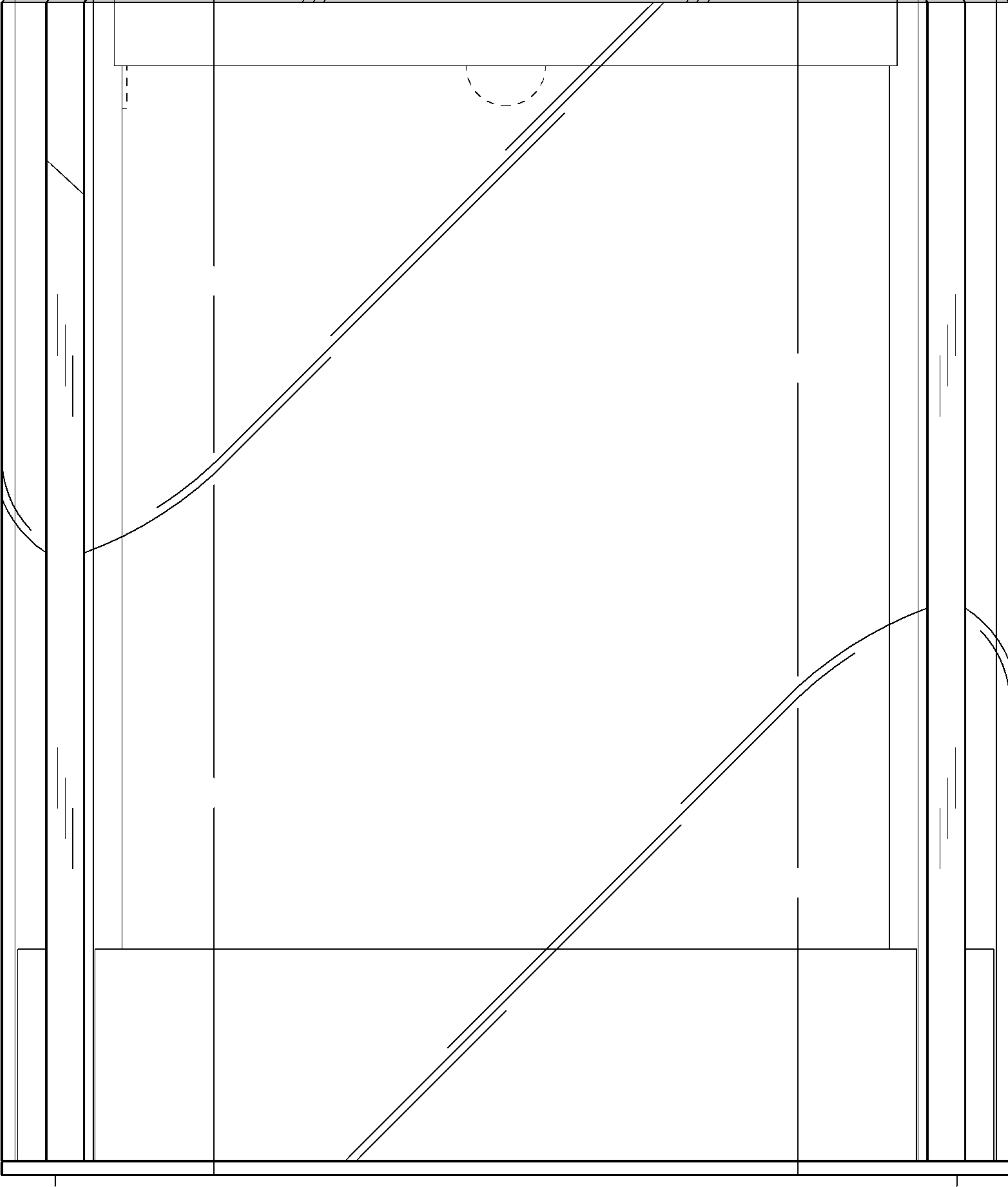

FIG.5

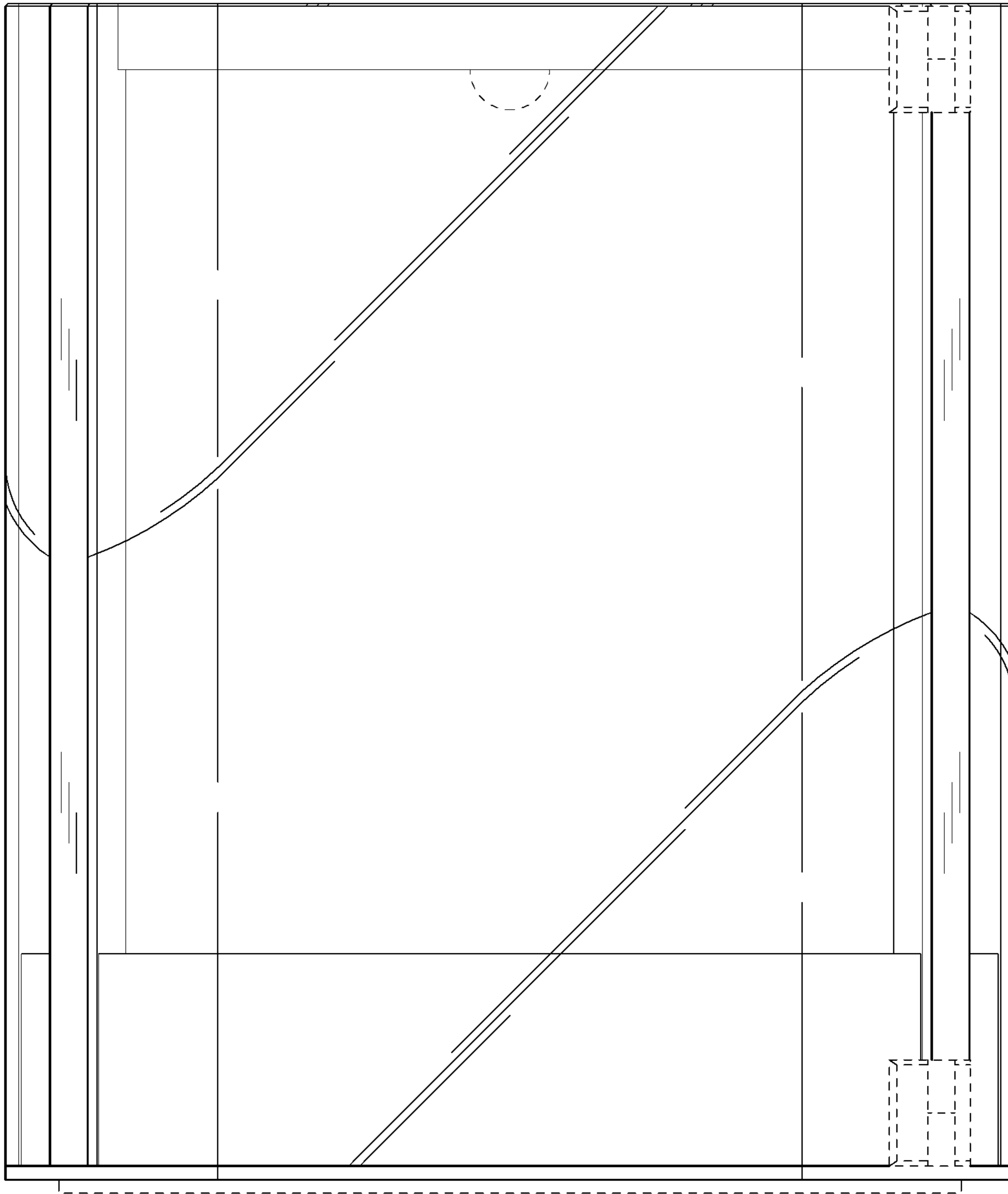

FIG.6

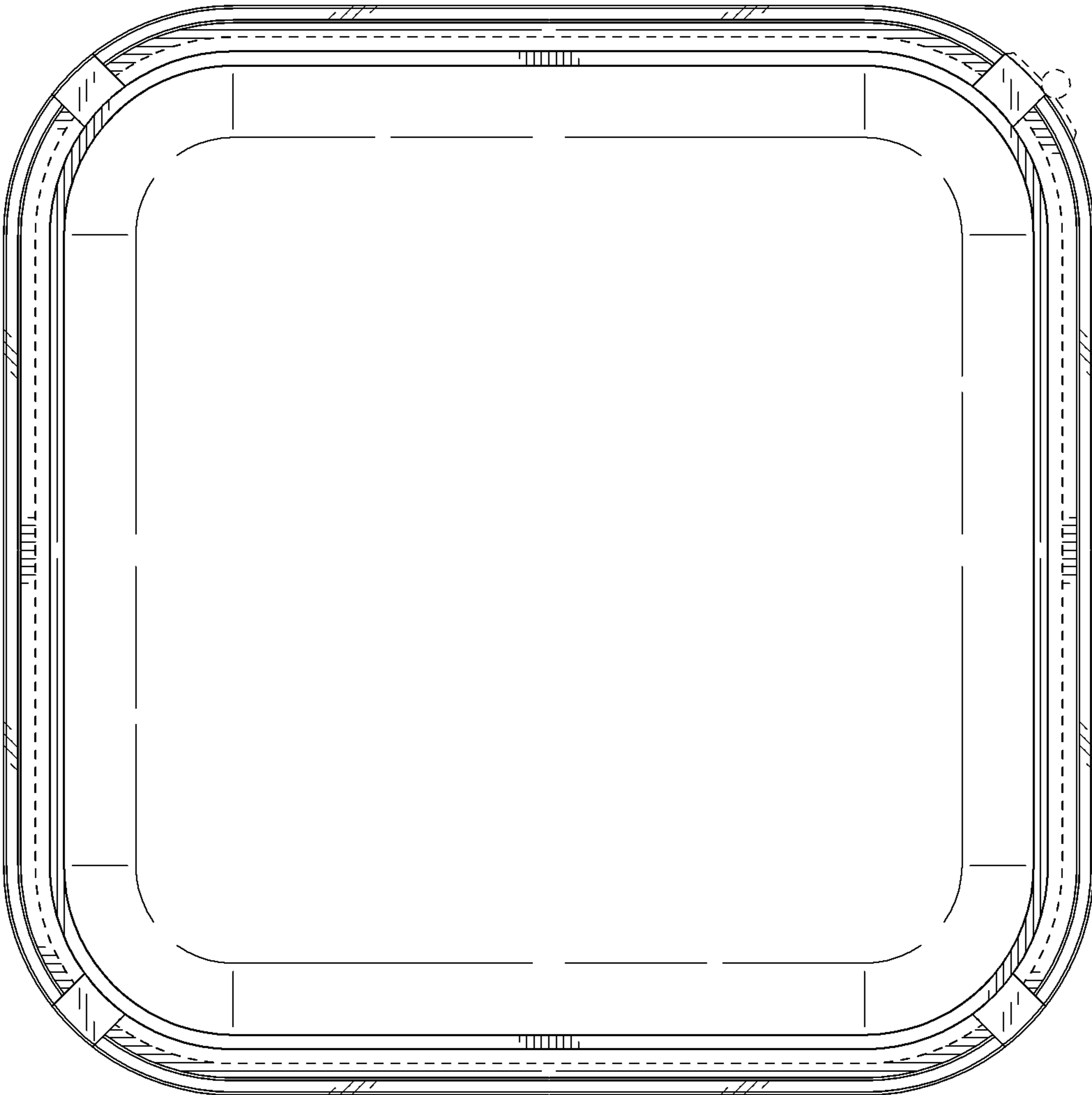



FIG.7

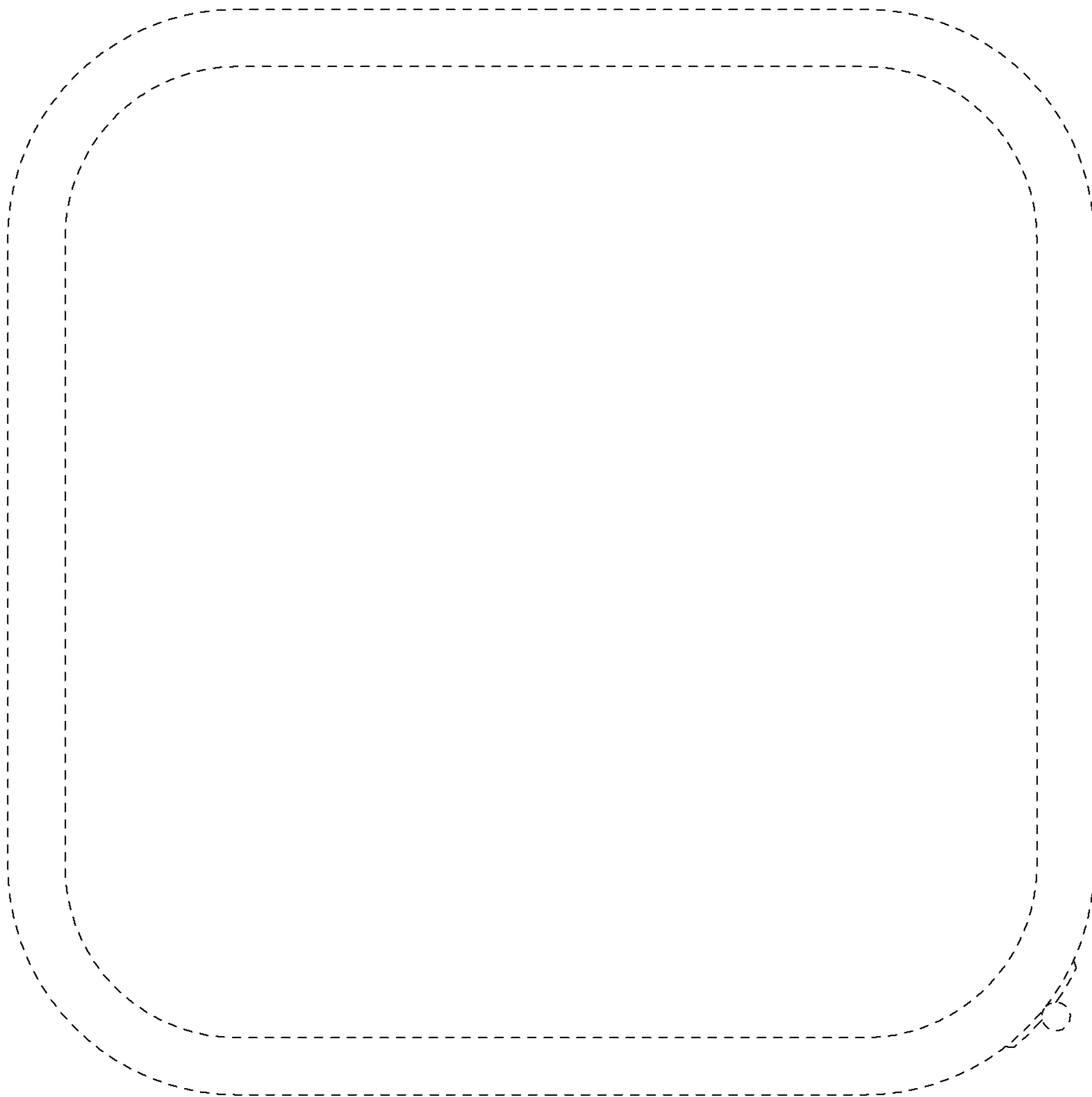

FIG.8

