



US00D977960S

(12) **United States Design Patent**
Stegmann et al.

(10) **Patent No.:** **US D977,960 S**
(45) **Date of Patent:** **** Feb. 14, 2023**

(54) **PACKAGING BOX**

DESCRIPTION

- (71) Applicant: **Caterpillar Inc.**, Deerfield, IL (US)
- (72) Inventors: **Catrin Stegmann**, Kiel (DE); **Sabine Kosub**, Kiel (DE)
- (73) Assignee: **Caterpillar Inc.**, Peoria, IL (US)
- (**) Term: **15 Years**
- (21) Appl. No.: **29/713,473**
- (22) Filed: **Nov. 15, 2019**
- (30) **Foreign Application Priority Data**
- May 17, 2019 (EM) 006480075
- (51) **LOC (14) Cl.** **09-03**
- (52) **U.S. Cl.**
- USPC **D9/414**
- (58) **Field of Classification Search**
- USPC D9/414, 432, 434, 759, 499, 667, 737, D9/423

(Continued)

(56) **References Cited**

U.S. PATENT DOCUMENTS

- D656,018 S * 3/2012 Hablutzel D9/434
- D709,364 S * 7/2014 Olsson D9/432

(Continued)

OTHER PUBLICATIONS

MaK Middle East, "Services—Service Warranty", <http://www.mak-catmarine.com/en_SA/services/service-warranty.html>, accessed Feb. 14, 2020.

(Continued)

Primary Examiner — Rhea Shields

(57) **CLAIM**

The ornamental design for a packaging box, as shown and described.

The file of this patent contains at least one drawing/photograph executed in color. Copies of this patent with color drawing(s)/photograph(s) will be provided by the Office upon request and payment of the necessary fee.

FIG. 1 is a perspective view of a packaging box showing our new design;

FIG. 2 is a front view thereof;

FIG. 3 is a rear view thereof;

FIG. 4 is a left side view thereof;

FIG. 5 is a right side view;

FIG. 6 is a top view thereof;

FIG. 7 is a bottom view thereof;

FIG. 8 is a perspective view of another embodiment thereof;

FIG. 9 is a front view thereof;

FIG. 10 is a rear view thereof;

FIG. 11 is a left side view thereof;

FIG. 12 is a right side view;

FIG. 13 is a top view thereof;

FIG. 14 is a bottom view thereof;

FIG. 15 is a perspective view of another embodiment thereof;

FIG. 16 is a front view thereof;

FIG. 17 is a rear view thereof;

FIG. 18 is a left side view thereof;

FIG. 19 is a right side view;

FIG. 20 is a top view thereof;

FIG. 21 is a bottom view thereof;

FIG. 22 is a perspective view of another embodiment thereof;

FIG. 23 is a front view thereof;

FIG. 24 is a rear view thereof;

FIG. 25 is a left side view thereof;

FIG. 26 is a right side view;

FIG. 27 is a top view thereof;

FIG. 28 is a bottom view thereof;

FIG. 29 is a perspective view of another embodiment thereof;

FIG. 30 is a front view thereof;

FIG. 31 is a rear view thereof;

FIG. 32 is a left side view thereof;

FIG. 33 is a right side view;

FIG. 34 is a top view thereof;

(Continued)

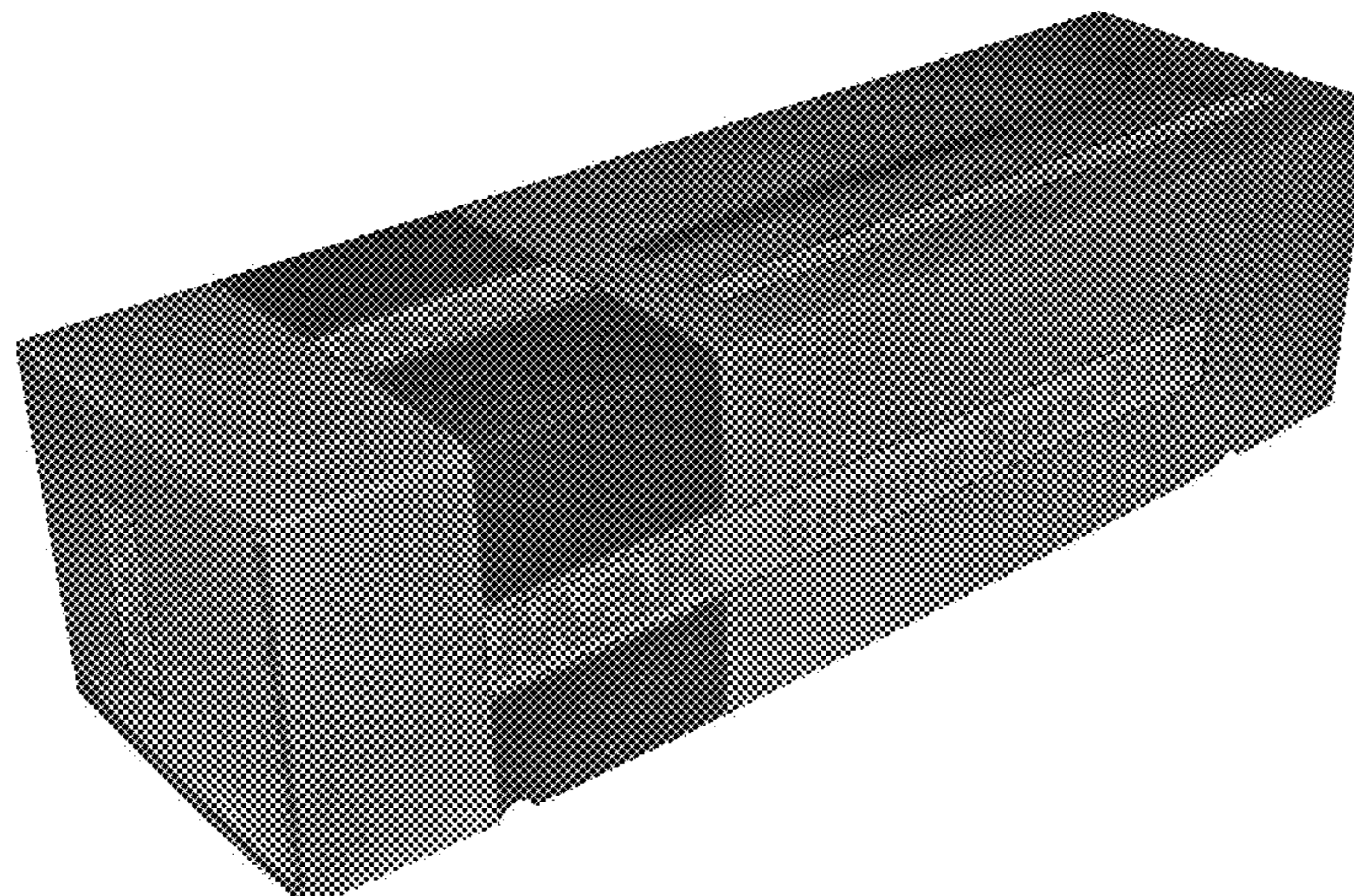

FIG. 35 is a bottom view thereof;
 FIG. 36 is a perspective view of another embodiment thereof;
 FIG. 37 is a front view thereof;
 FIG. 38 is a rear view thereof;
 FIG. 39 is a left side view thereof;
 FIG. 40 is a right side view;
 FIG. 41 is a top view thereof; and,
 FIG. 42 is a bottom view thereof.
 The broken lines depict boundaries of the claimed design and the faded portions therein form no part of the claimed design.

**1 Claim, 42 Drawing Sheets
 (21 of 42 Drawing Sheet(s) Filed in Color)**

(58) **Field of Classification Search**
 CPC B65D 77/26
 See application file for complete search history.

(56) **References Cited**

U.S. PATENT DOCUMENTS

D748,474	S	*	2/2016	Choi	D9/434
D779,327	S	*	2/2017	Fraser	D9/499
D820,673	S	*	6/2018	Augustyniak	D9/423
10,053,274	B1	*	8/2018	O'Neill	B65D 77/26
D829,569	S	*	10/2018	O'Neill	D9/759
D846,381	S	*	4/2019	Akrapovic	D9/432
D852,621	S	*	7/2019	Thompson	D9/432
D871,210	S	*	12/2019	Clifton	D9/432
D874,925	S	*	2/2020	Ronge	D9/432

D880,293	S	*	4/2020	Redding	D9/432
D892,632	S	*	8/2020	Bogdziewicz	D9/737
D896,100	S	*	9/2020	Wu	D9/667
D915,881	S	*	4/2021	Bin Ismail	D9/434
D915,882	S	*	4/2021	Caicedo	D9/434
D928,607	S	*	8/2021	Redding	D9/432

OTHER PUBLICATIONS

Caterpillar©, Cat® Parts Store, “136-0819: Valve Exhaust”, <<https://parts.cat.com/en/catcorp/engine-parts/exhaust/valves-1/136-0819>>, accessed Feb. 14, 2020.
 Caterpillar©, Cat® Parts Store, “157-7130: Valve Exhaust”, <<https://parts.cat.com/en/catcorp/engine-parts/exhaust/valves-1/157-7130>>, accessed Feb. 14, 2020.
 Caterpillar©, Cat® Parts Store, “248-1467: Valve Exhaust”, <<https://parts.cat.com/en/catcorp/engine-parts/exhaust/valves-1/248-1467>>, accessed Feb. 14, 2020.
 Caterpillar©, Cat® Parts Store, “294-1685: Valve Exhaust”, <<https://parts.cat.com/en/catcorp/engine-parts/exhaust/valves-1/294-1685>>, accessed Feb. 14, 2020.
 Caterpillar®, Cat® Parts Store, “339-9637: Valve Exhaust”, <<https://parts.cat.com/en/catcorp/engine-parts/exhaust/valves-1/339-9637>>, accessed Feb. 14, 2020.
 Caterpillar©, Cat® Parts Store, “464-4668: Valve Exhaust”, <<https://parts.cat.com/en/catcorp/engine-parts/eXhaust/valves-1/464-4668>>, accessed Feb. 14, 2020.
 Caterpillar®, Cat® Parts Store, “490-1723: Valve Exhaust”, <<https://parts.cat.com/en/catcorp/engine-parts/exhaust/valves-1/490-1723>>, accessed Feb. 14, 2020.
 Caterpillar©, Cat® Parts Store, “490-7198: Valve Exhaust”, <<https://parts.cat.com/en/catcorp/engine-parts/exhaust/values-1/490/7198>>, accessed Feb. 14, 2020.

* cited by examiner



FIG. 1

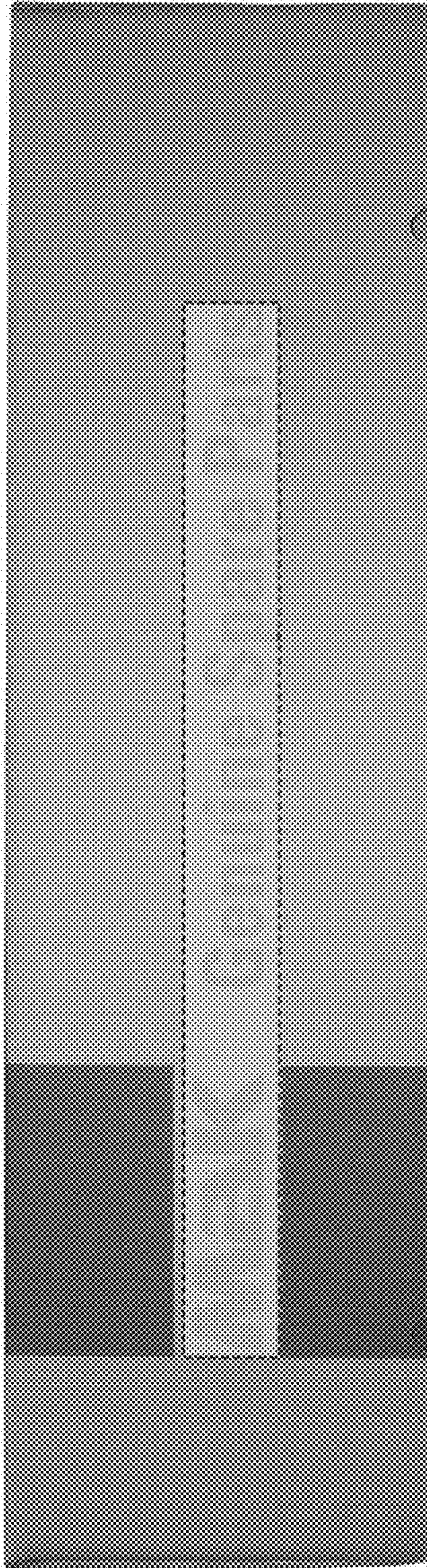

FIG. 2

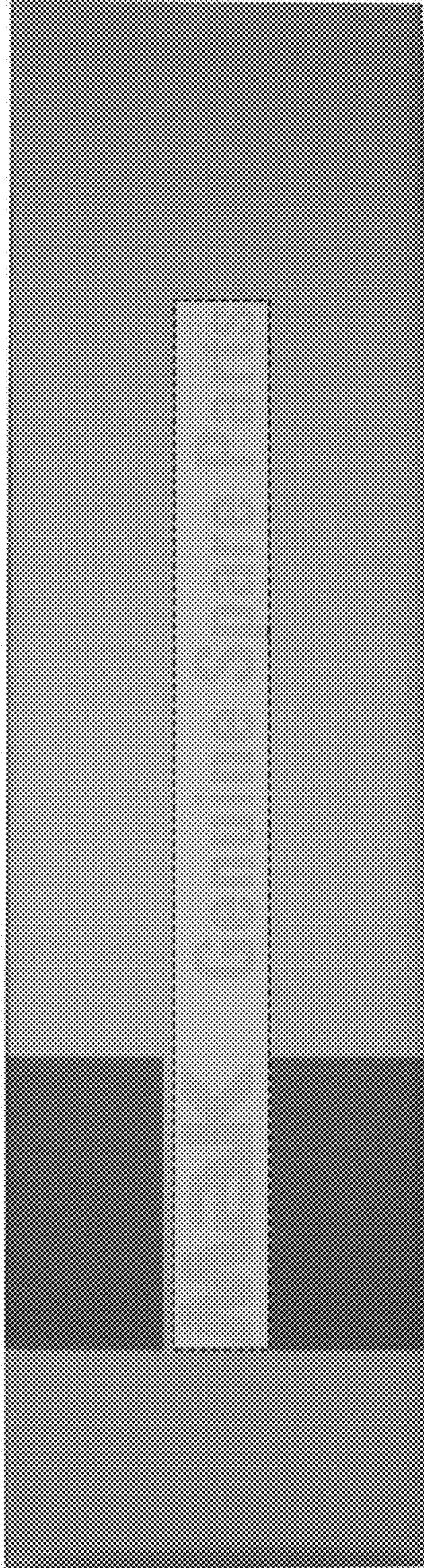

FIG. 3

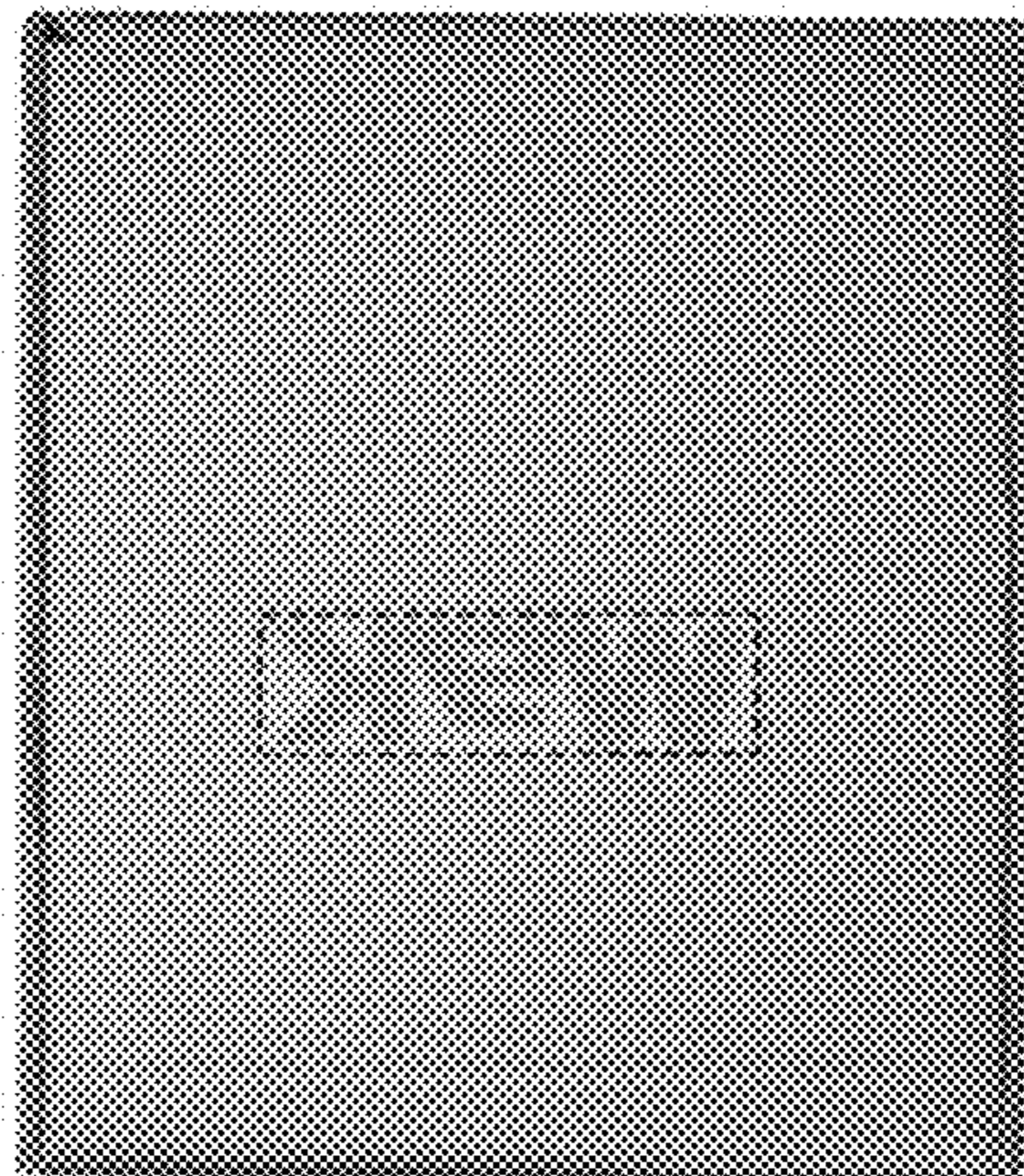

FIG. 4

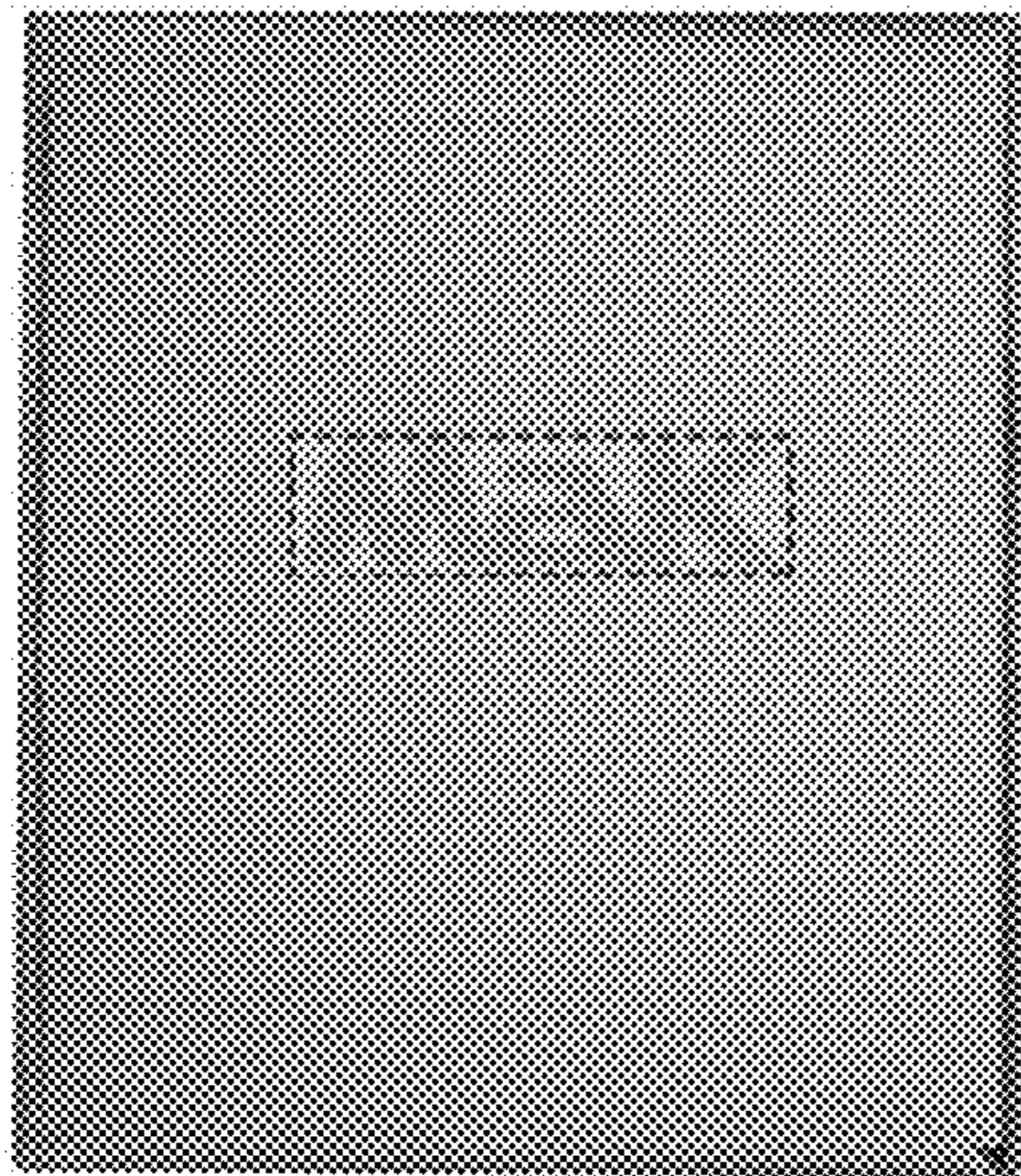

FIG. 5

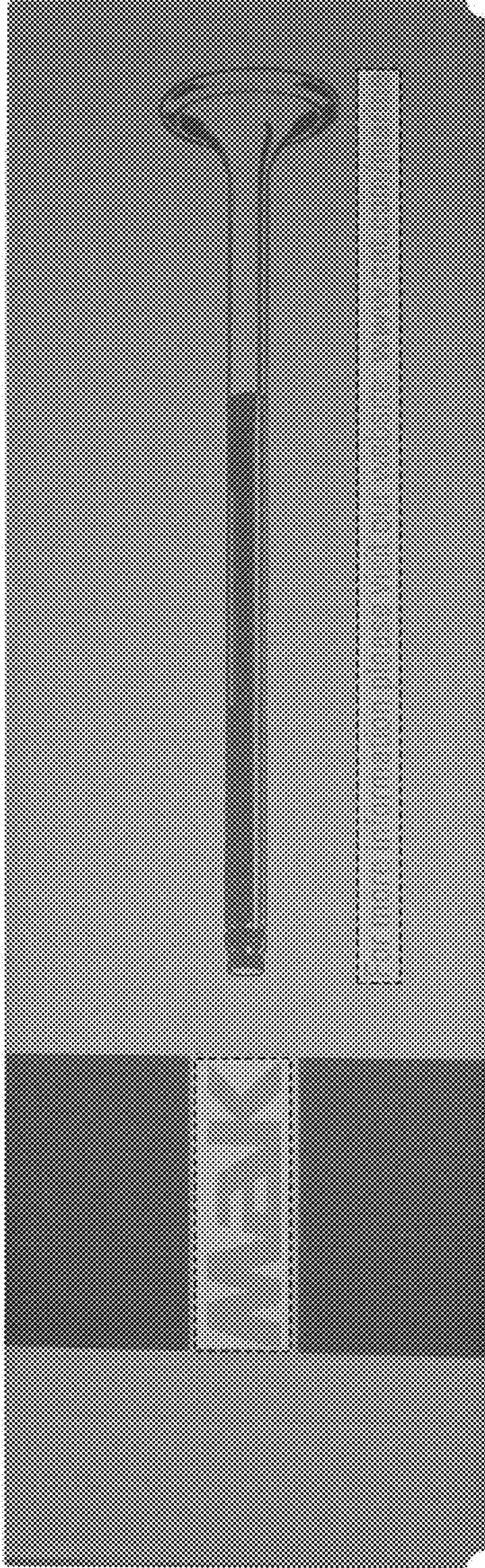

FIG. 6

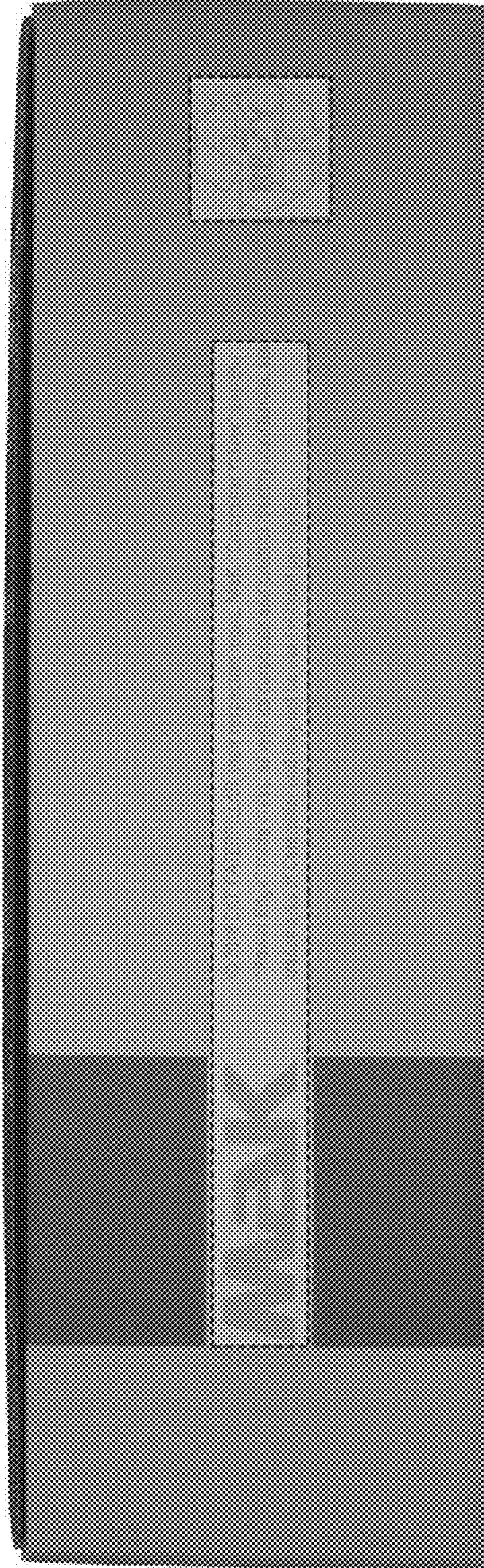

FIG. 7

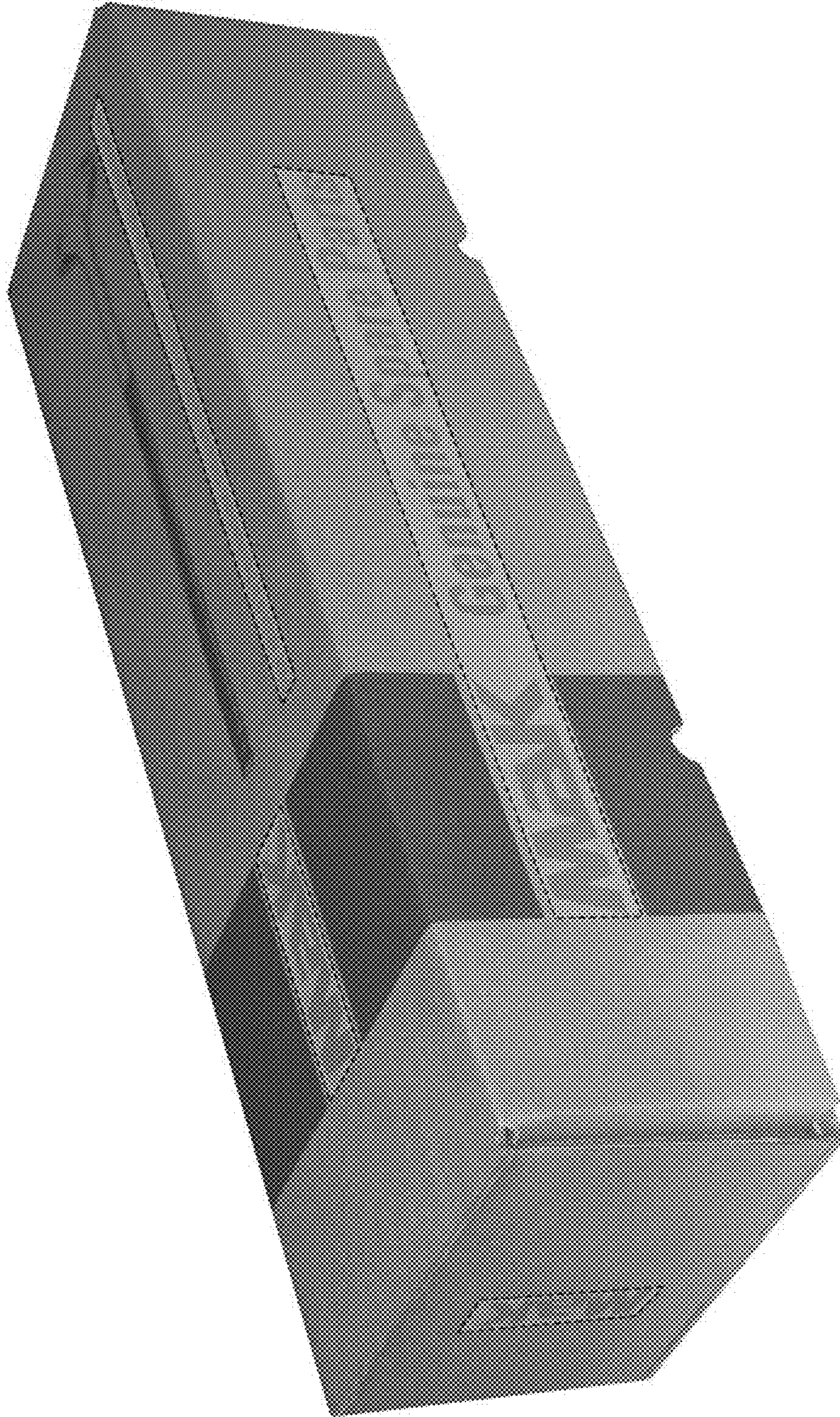

FIG. 8

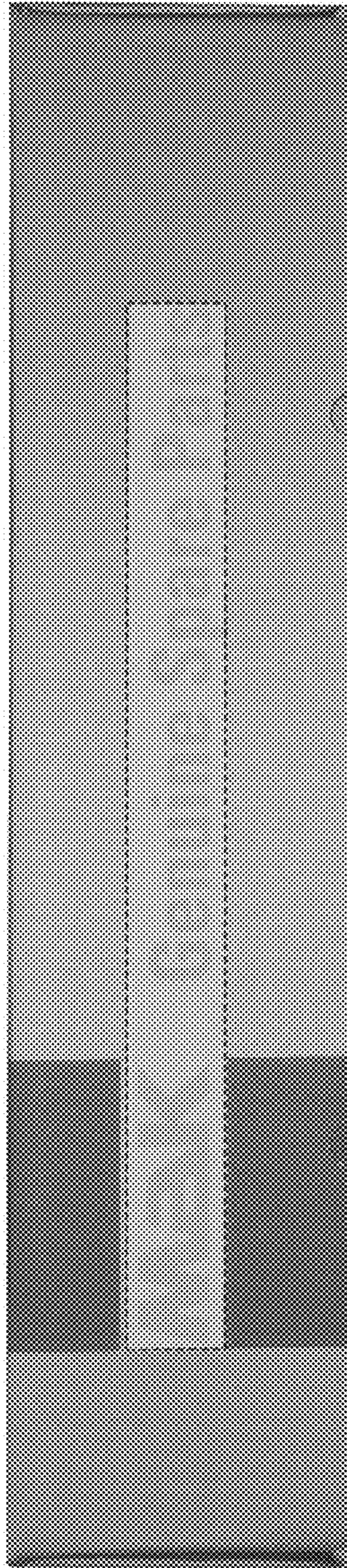

FIG. 9

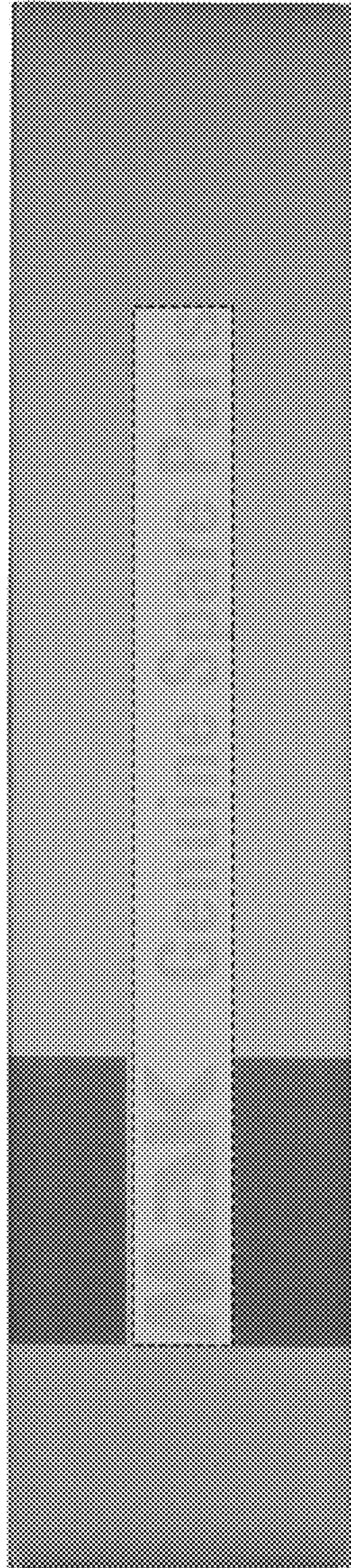

FIG. 10

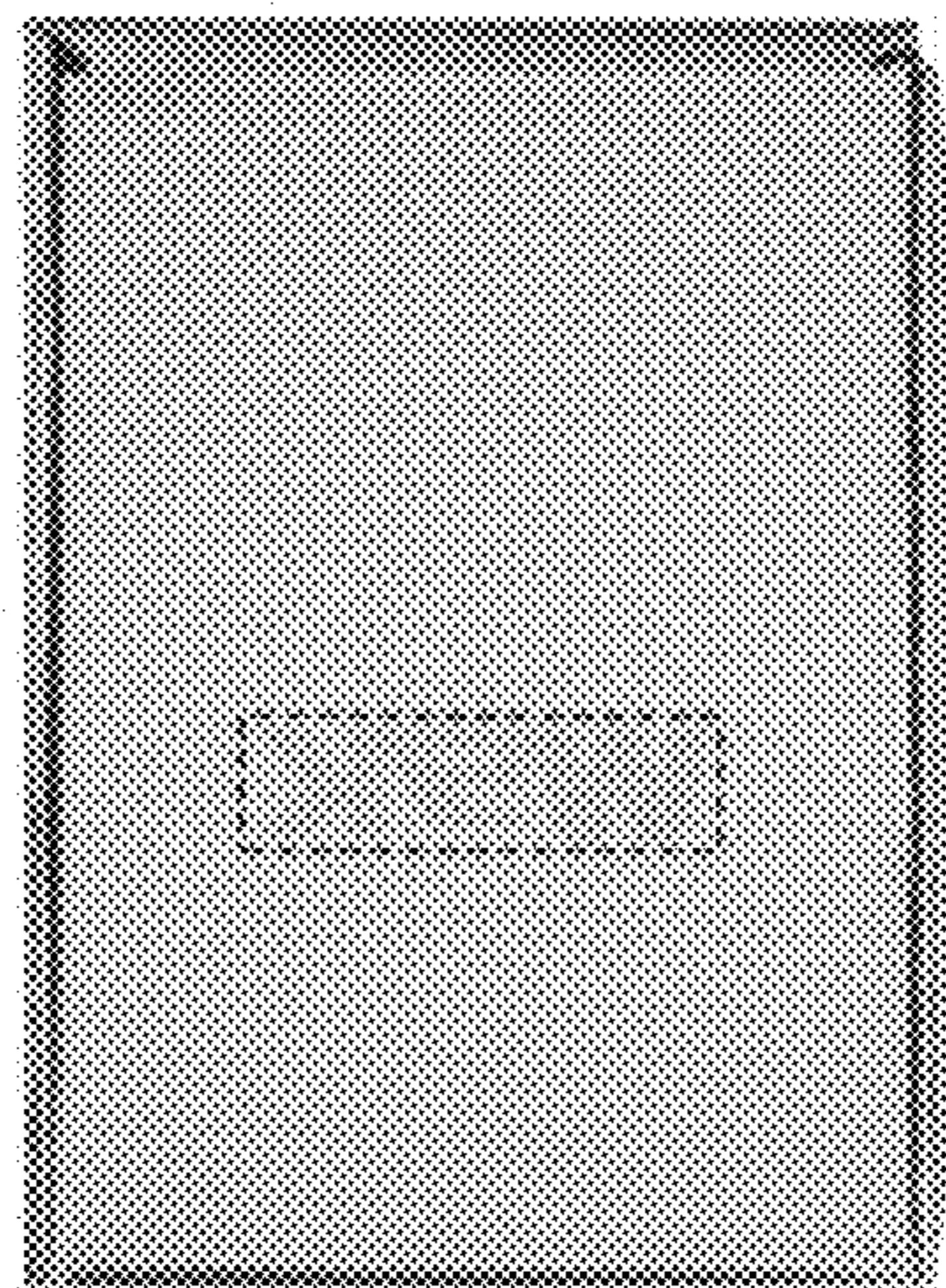

FIG. 11

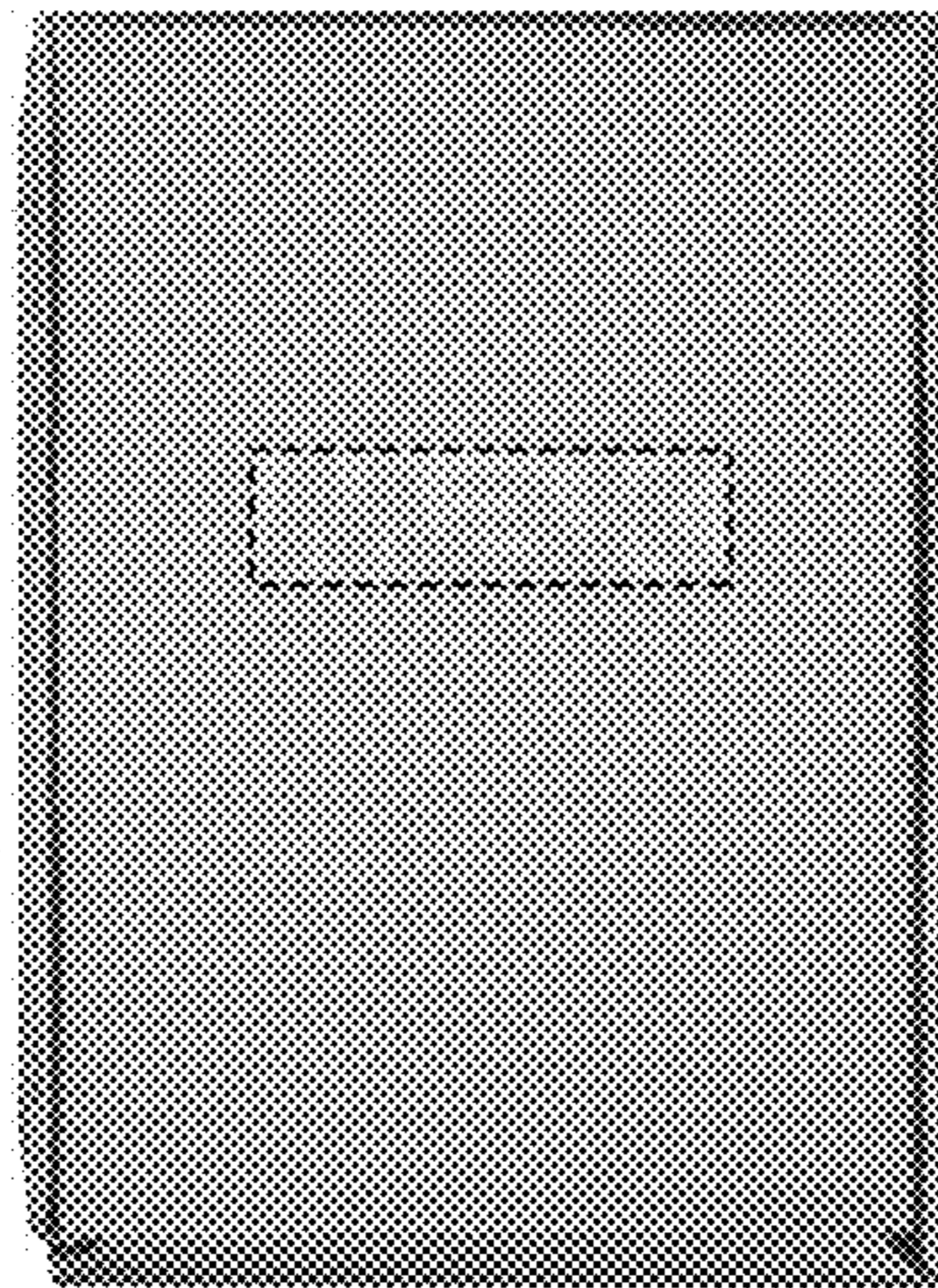

FIG. 12

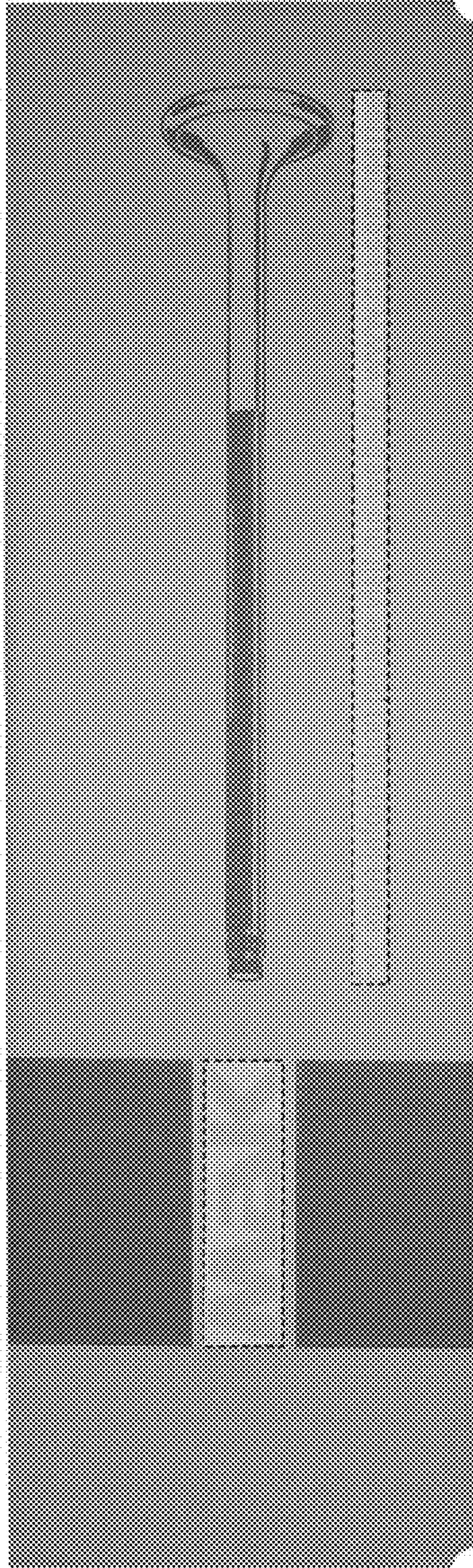

FIG. 13

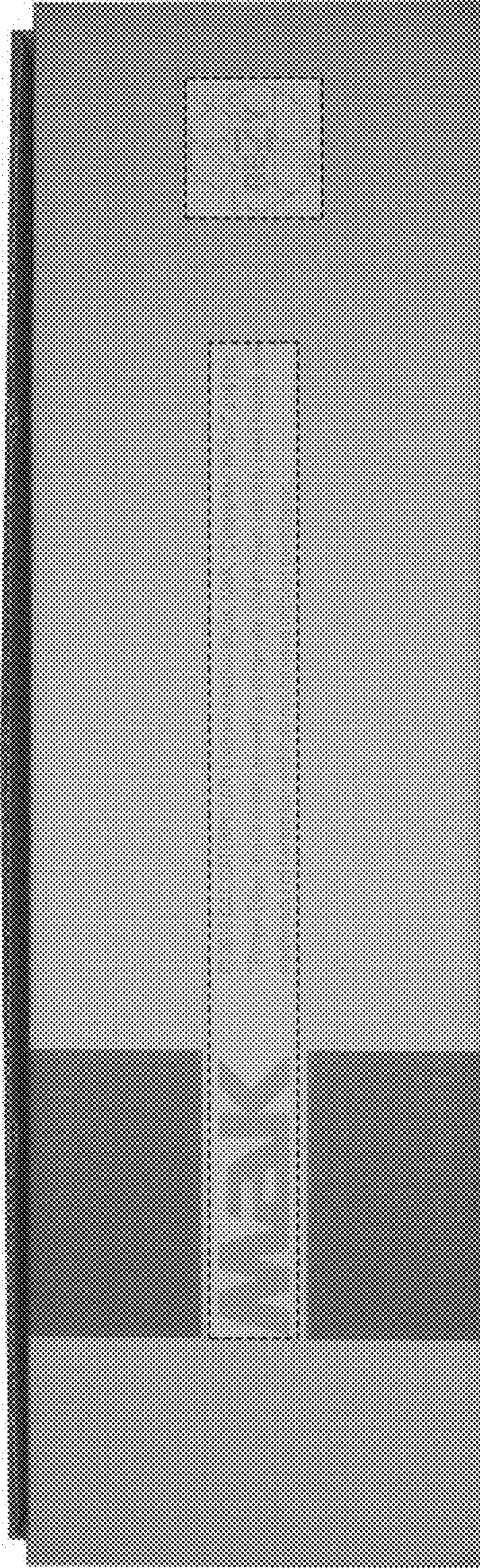

FIG. 14



FIG. 15

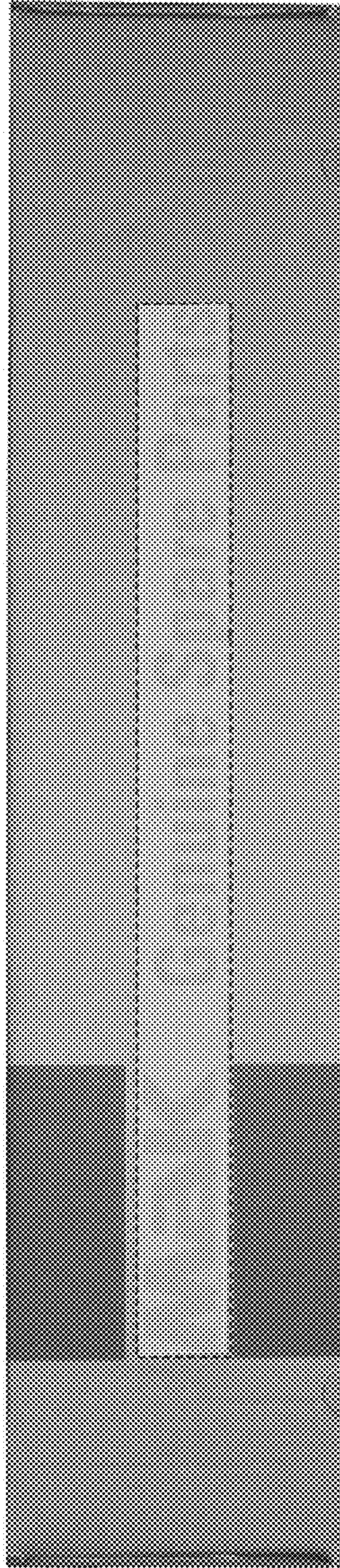

FIG. 16

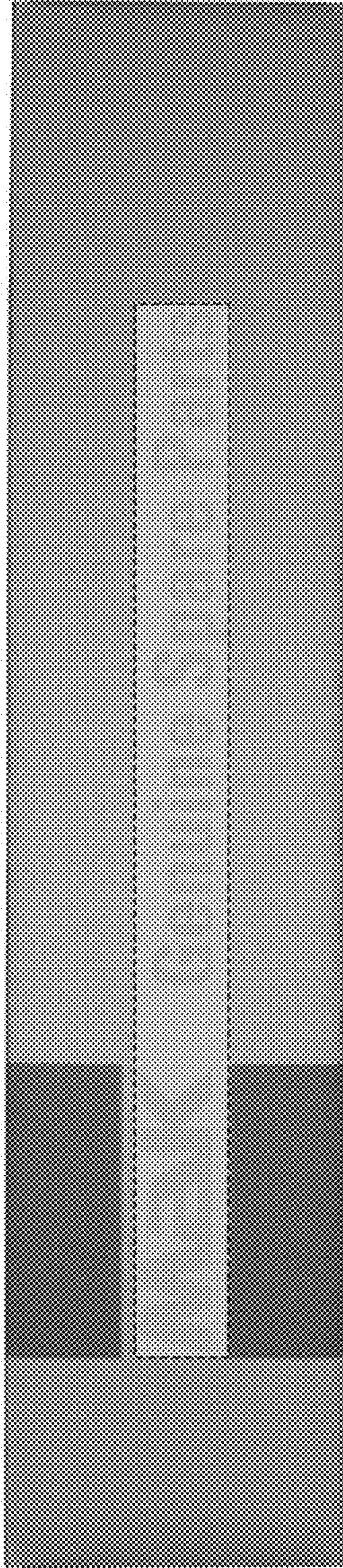

FIG. 17

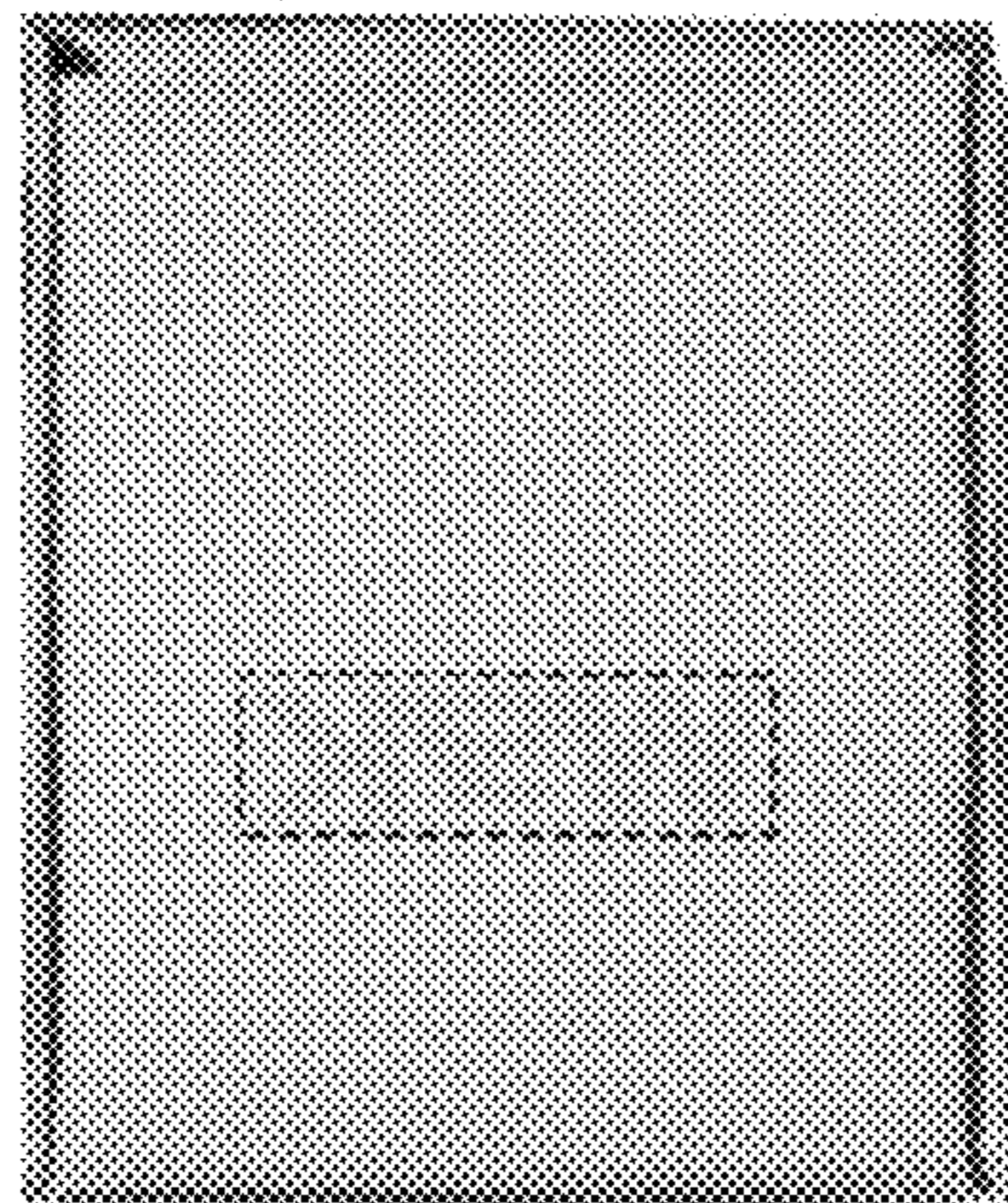

FIG. 18

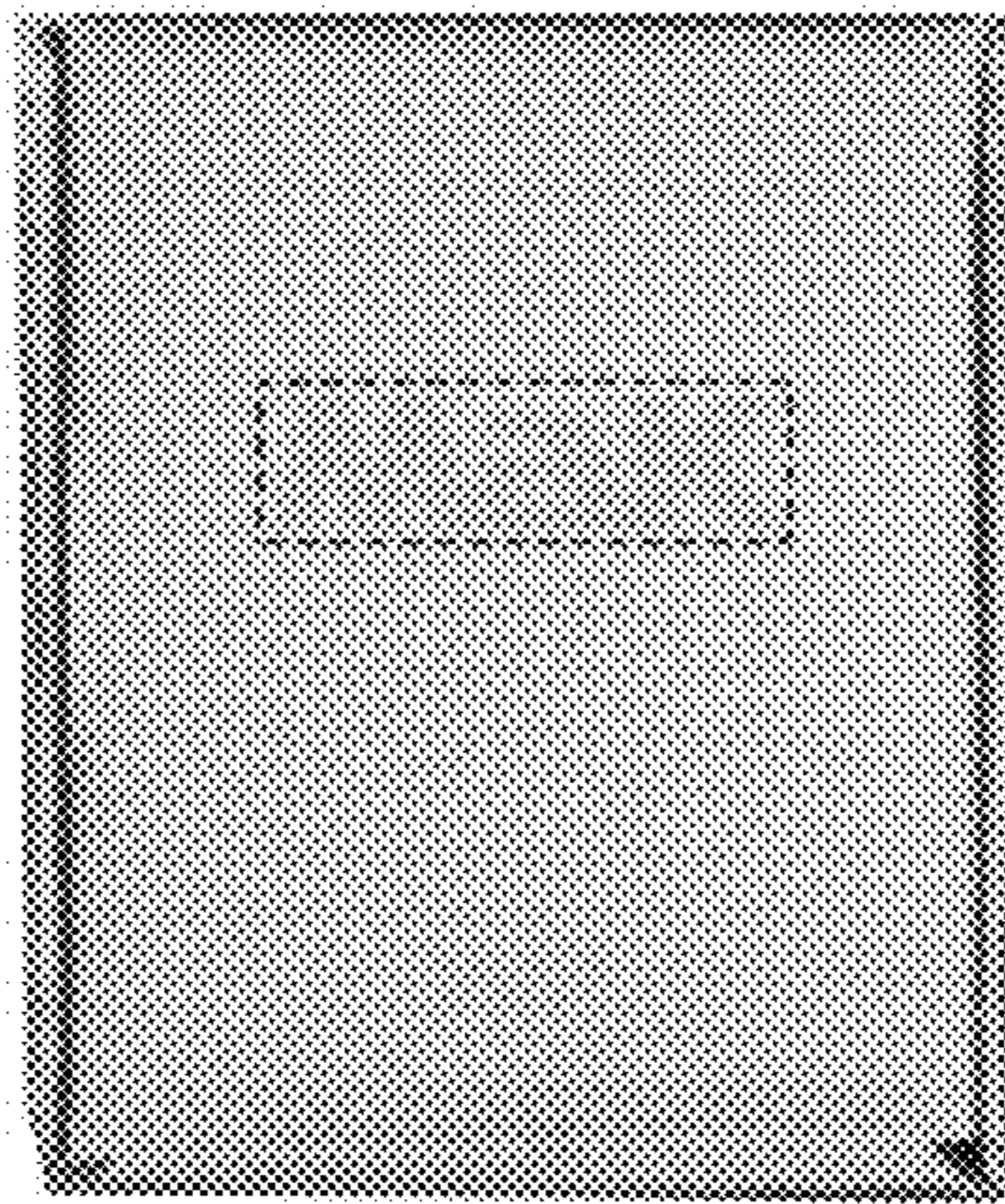

FIG. 19

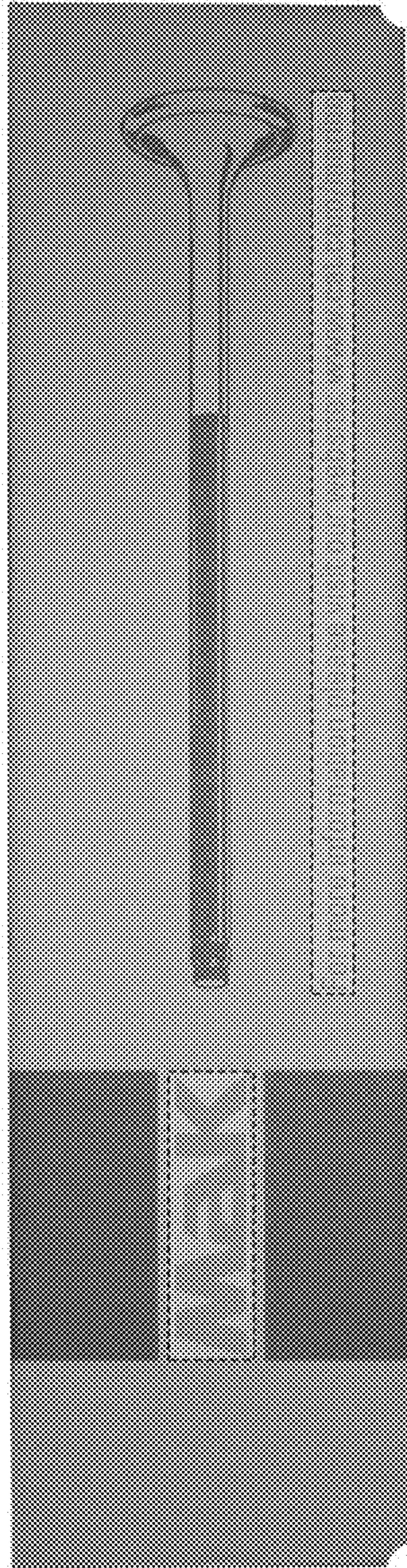

FIG. 20

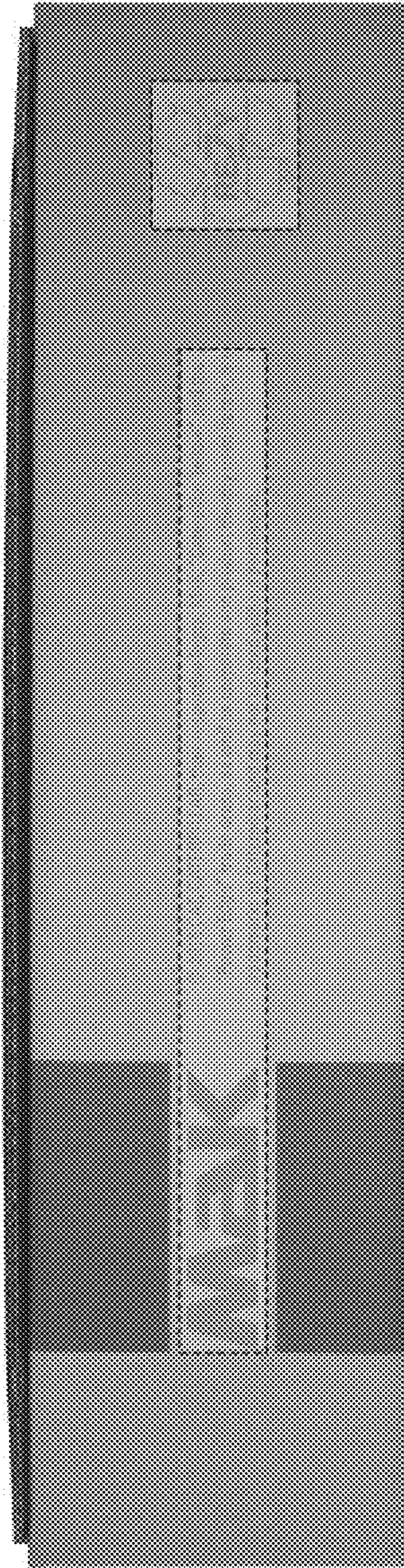

FIG. 21



FIG. 22

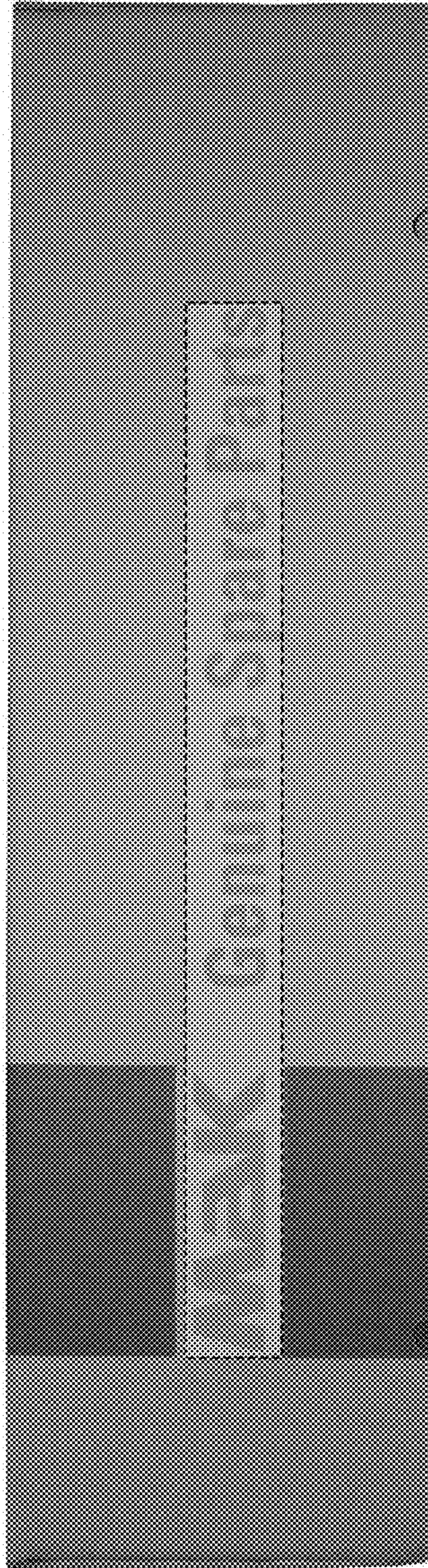

FIG. 23

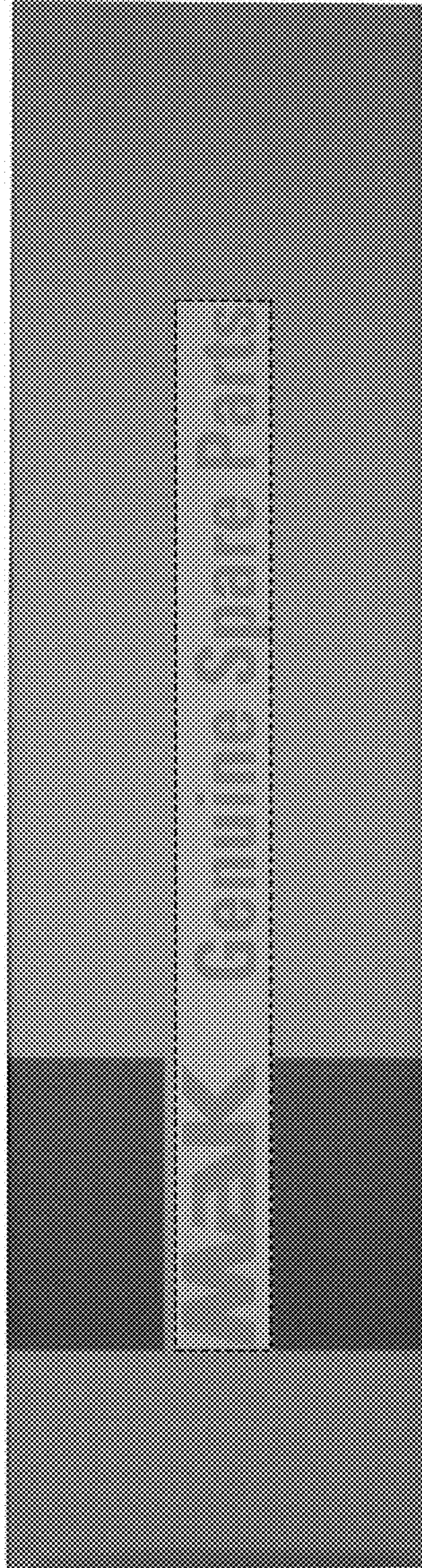

FIG. 24

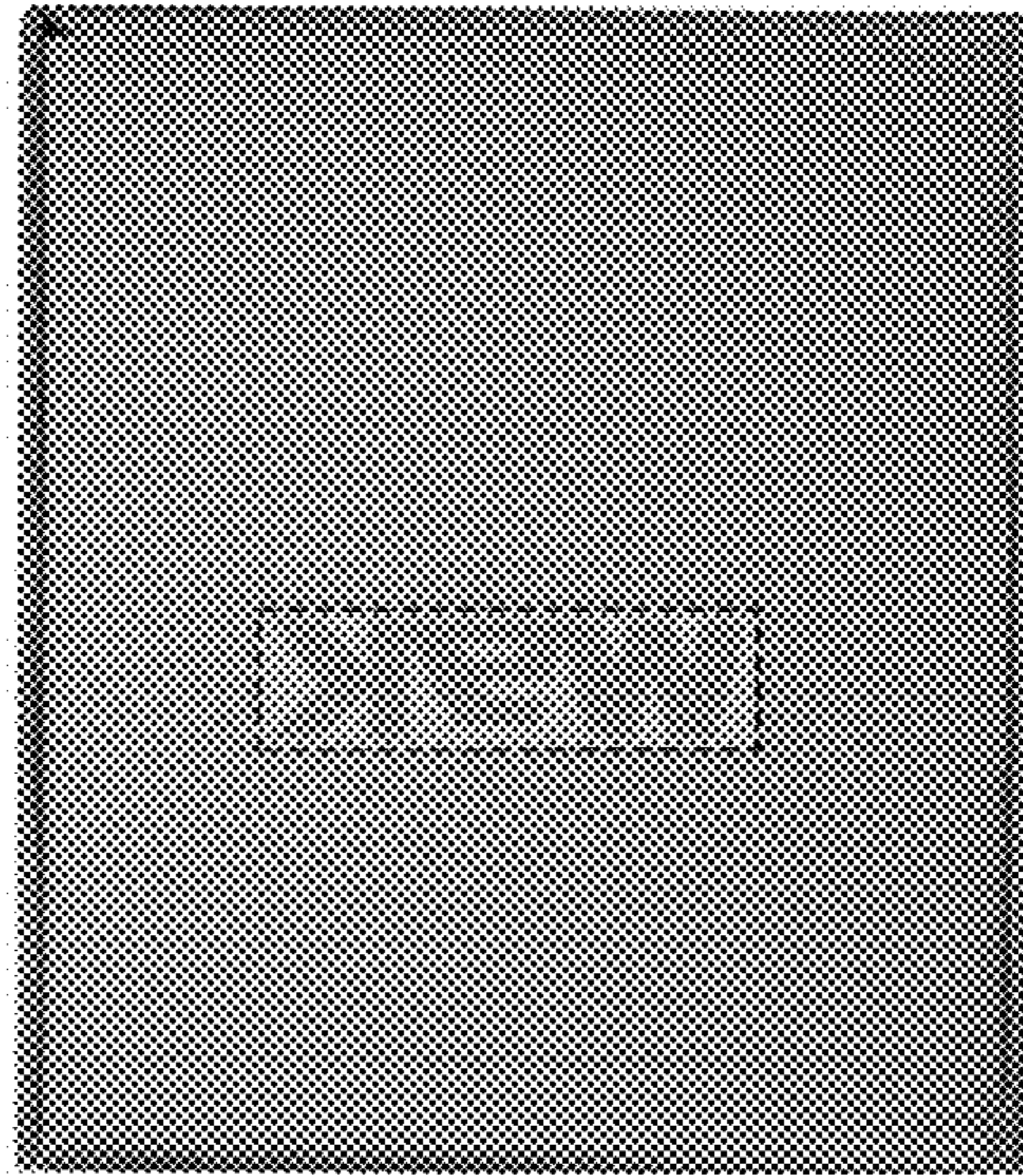

FIG. 25

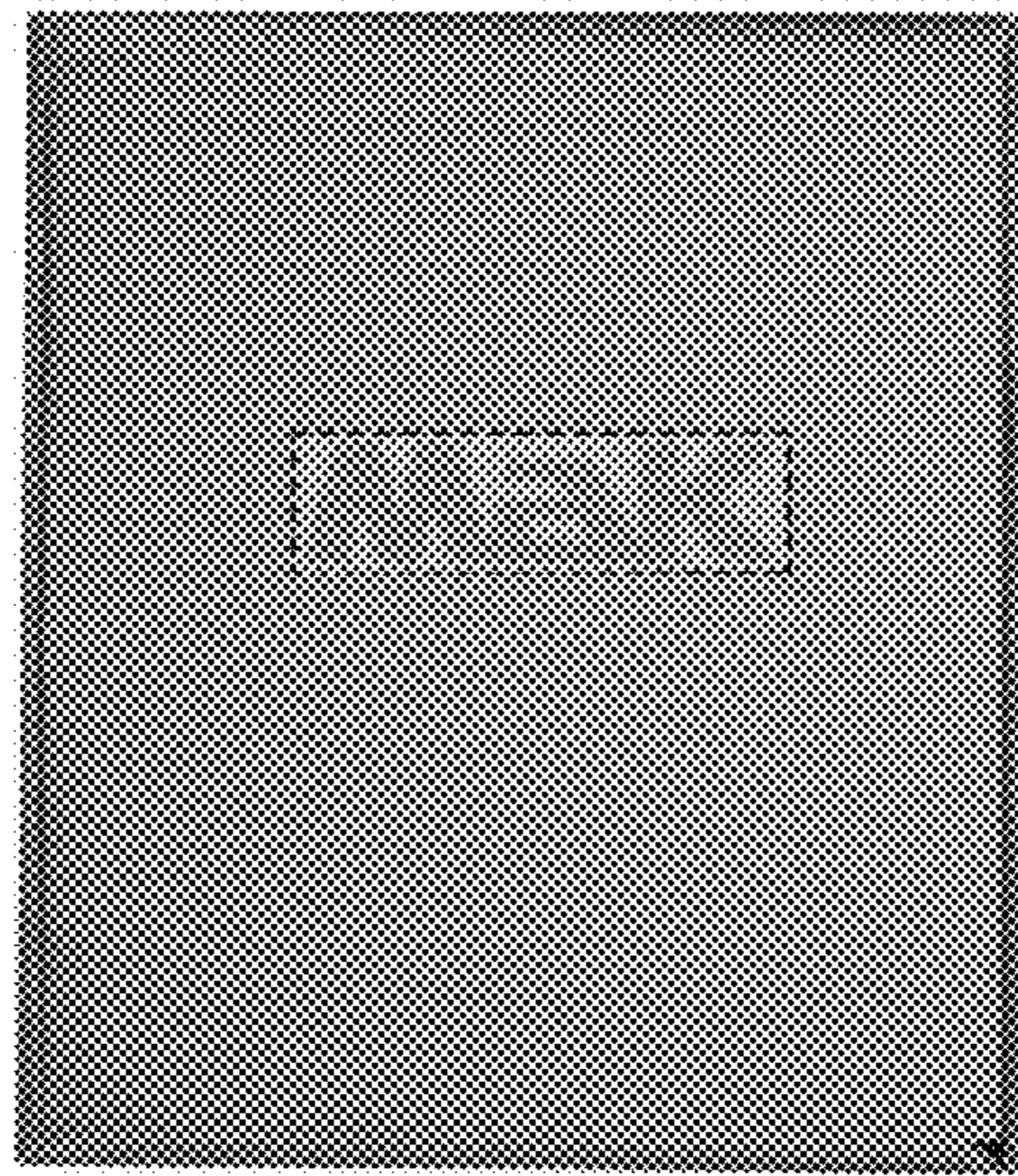

FIG. 26

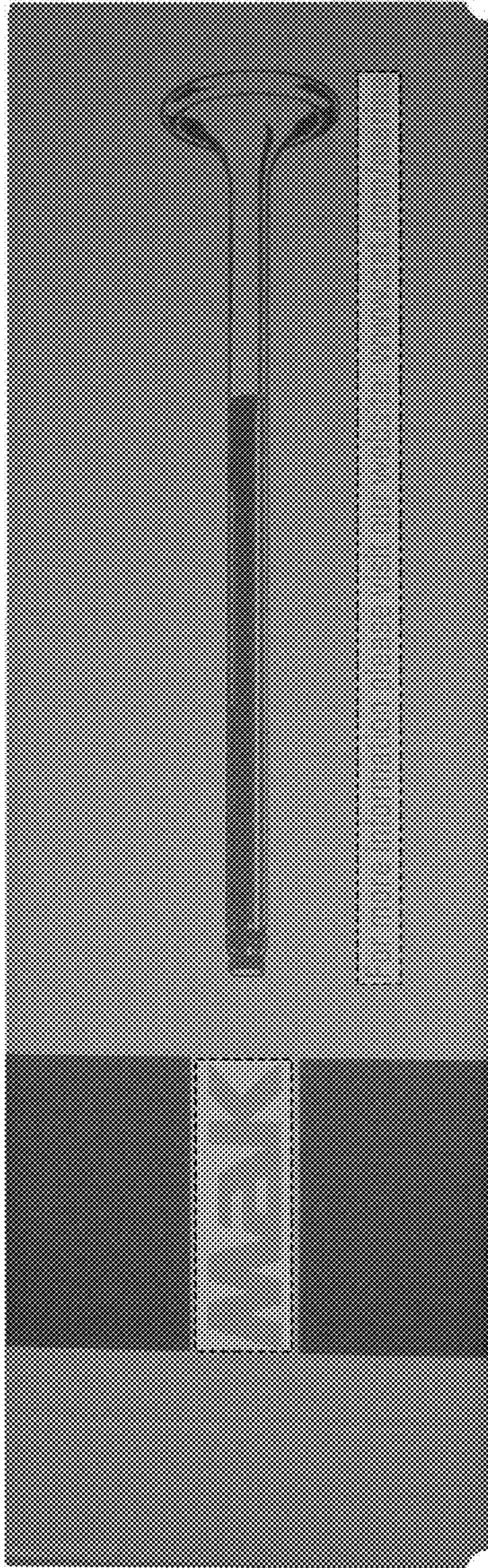

FIG. 27

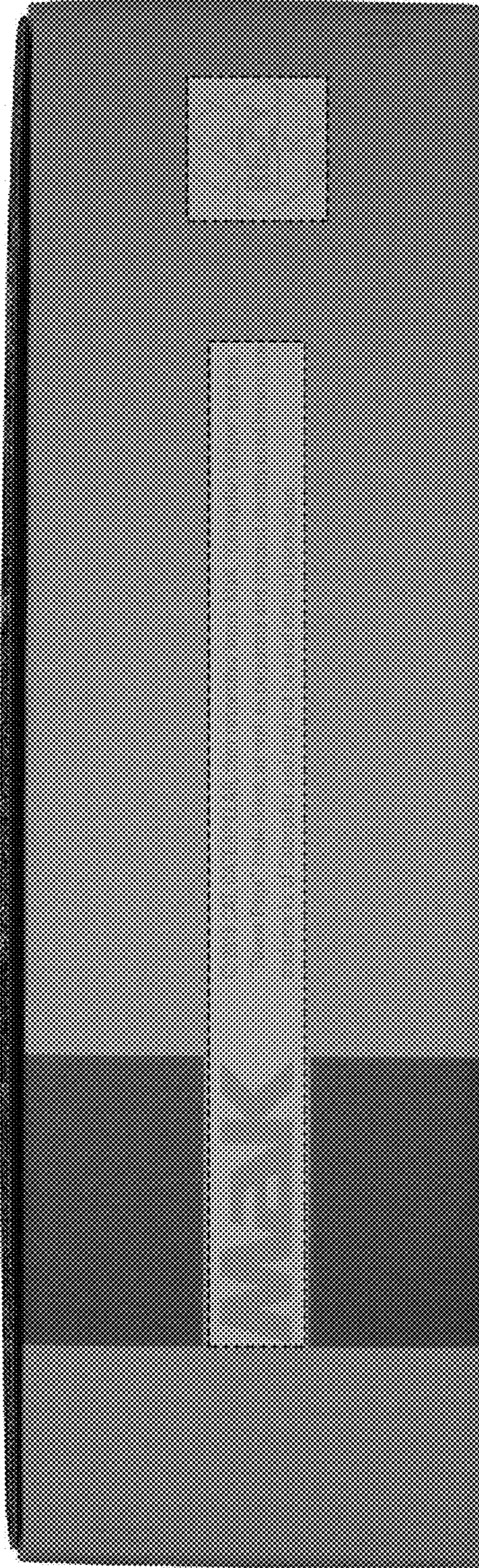

FIG. 28

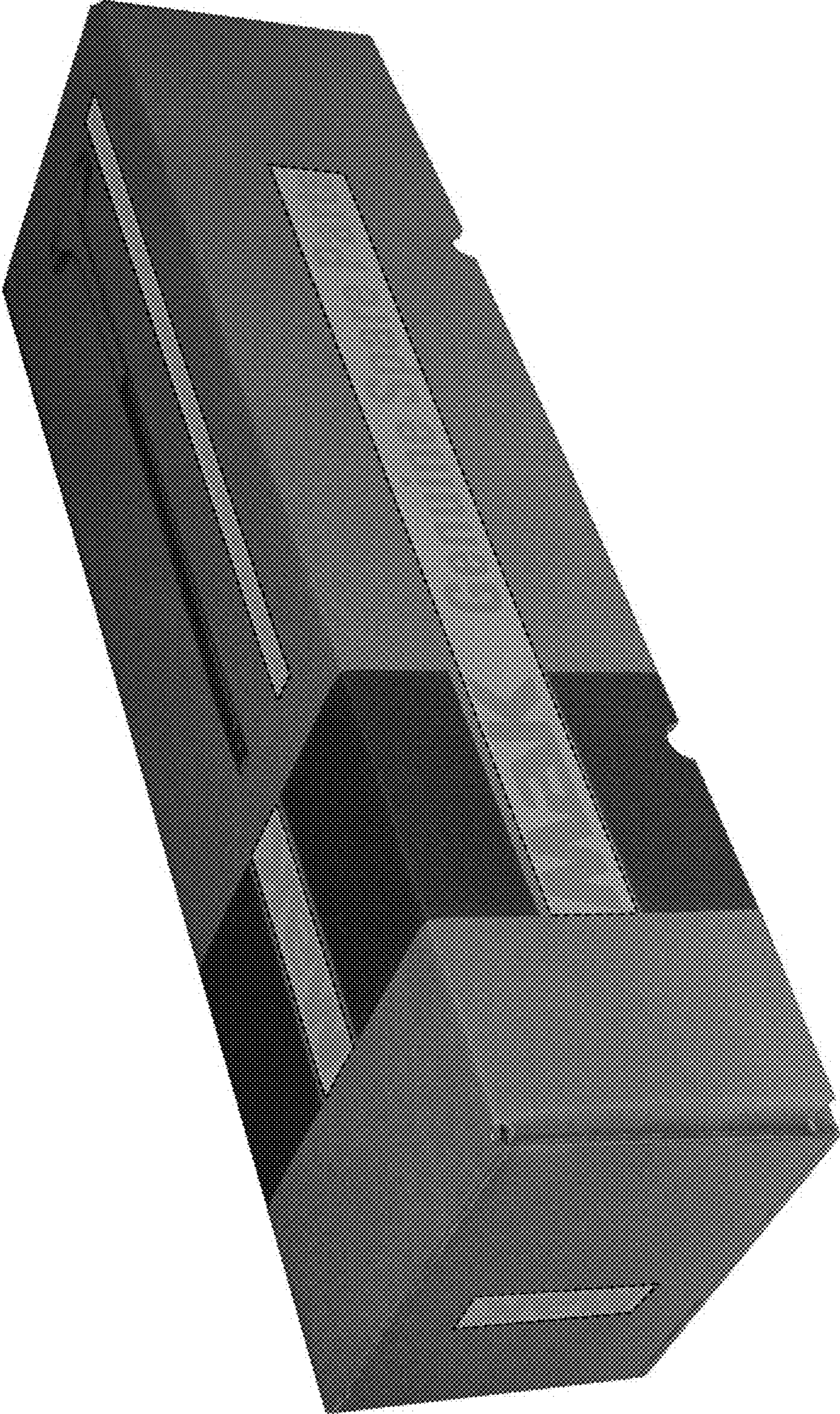

FIG. 29

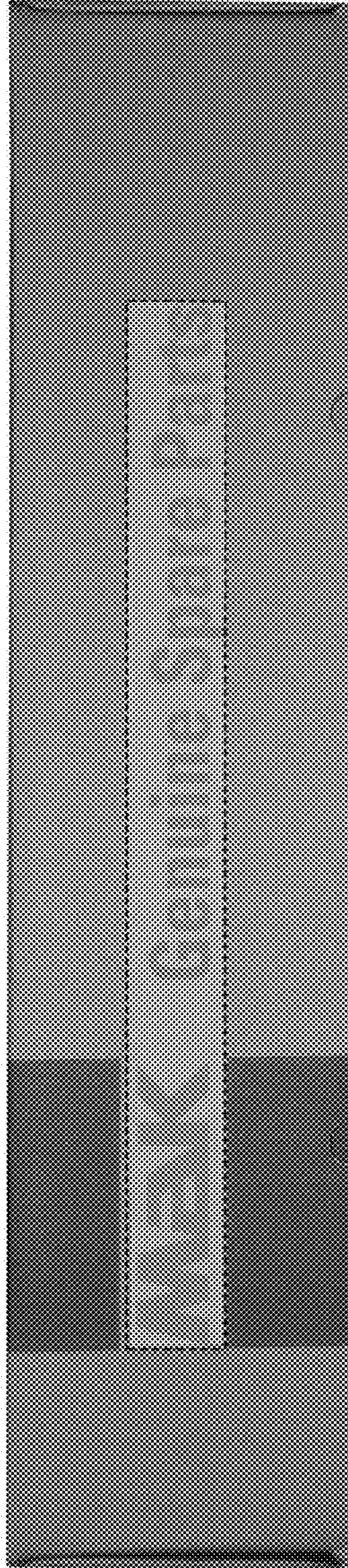

FIG. 30

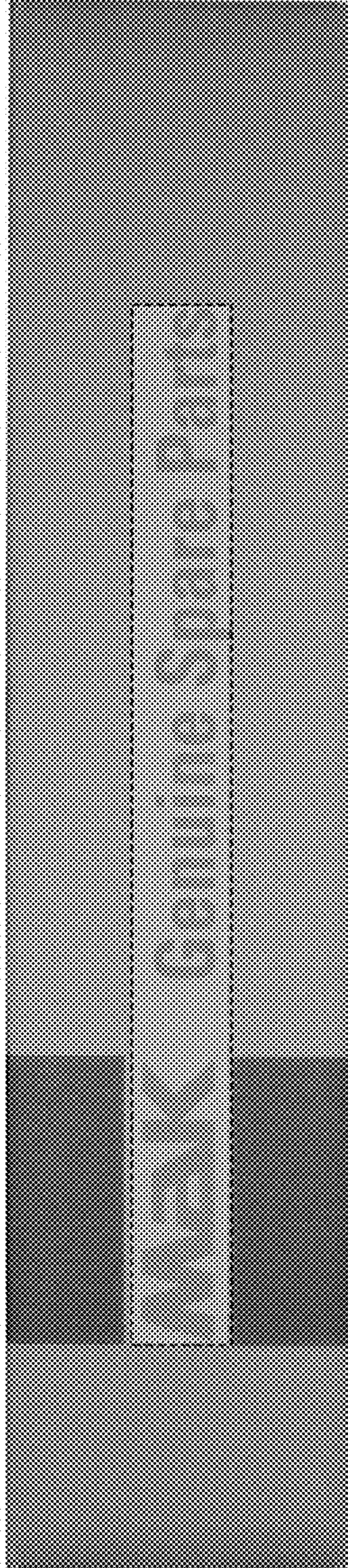

FIG. 31

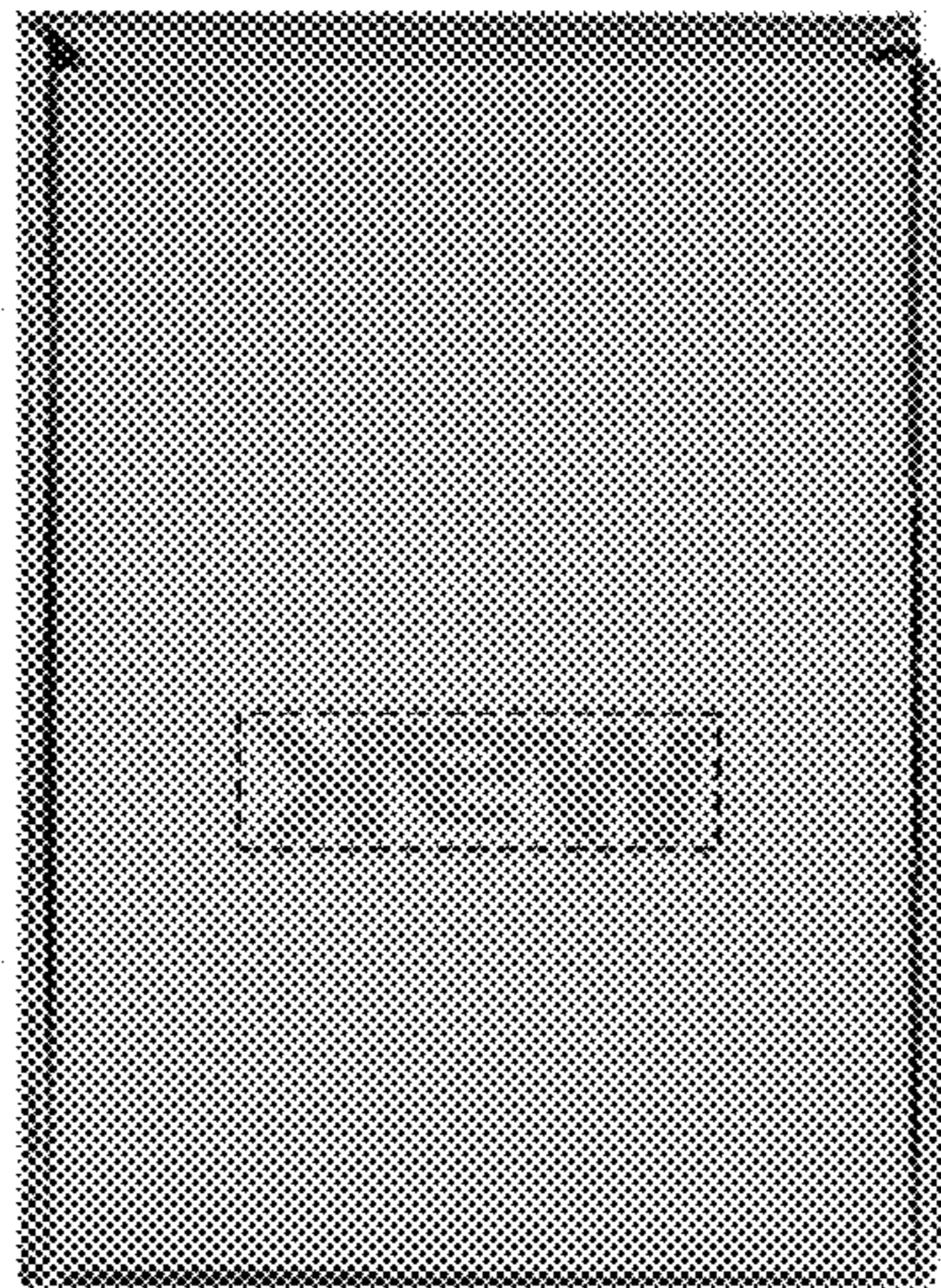

FIG. 32

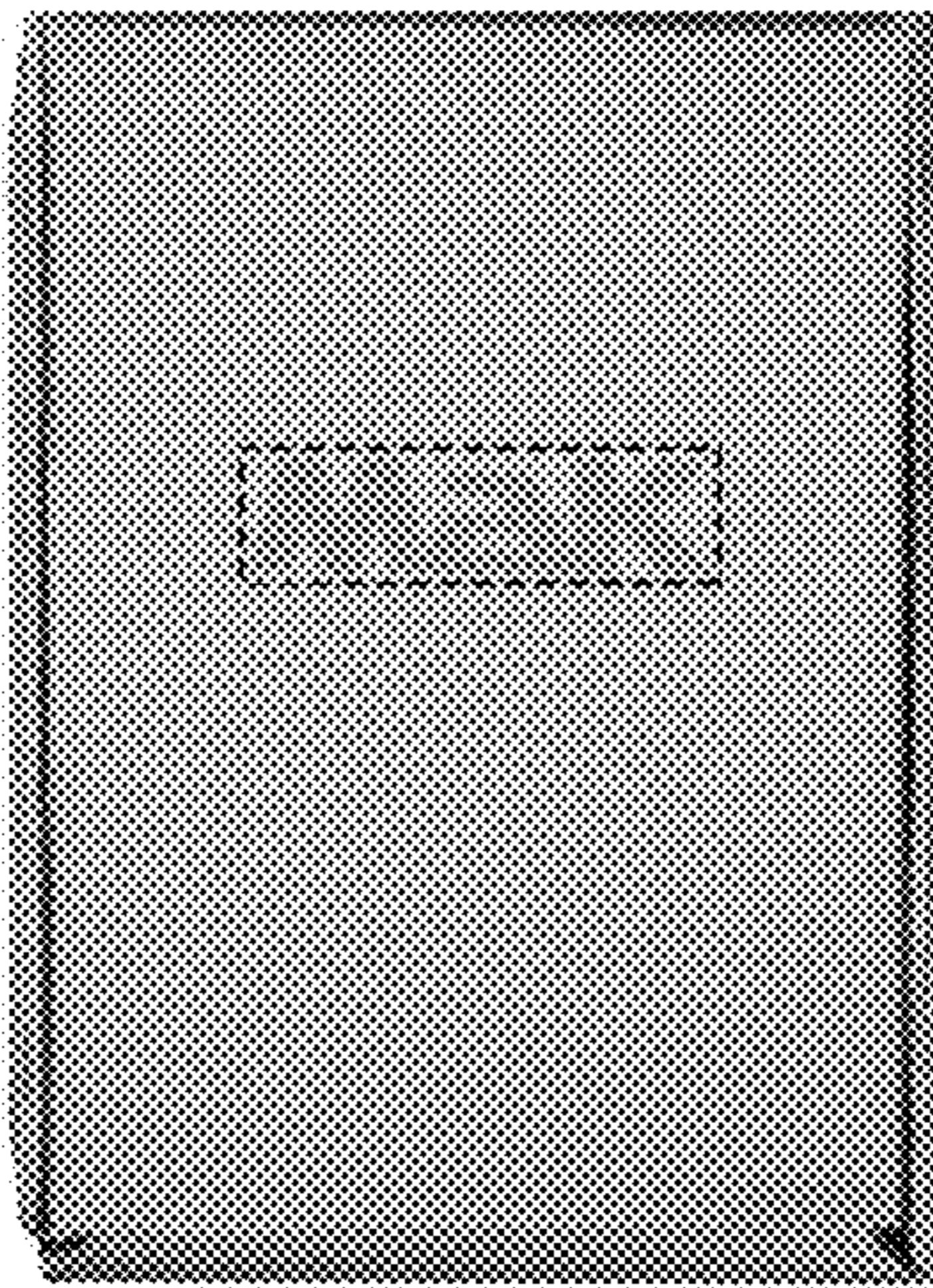

FIG. 33

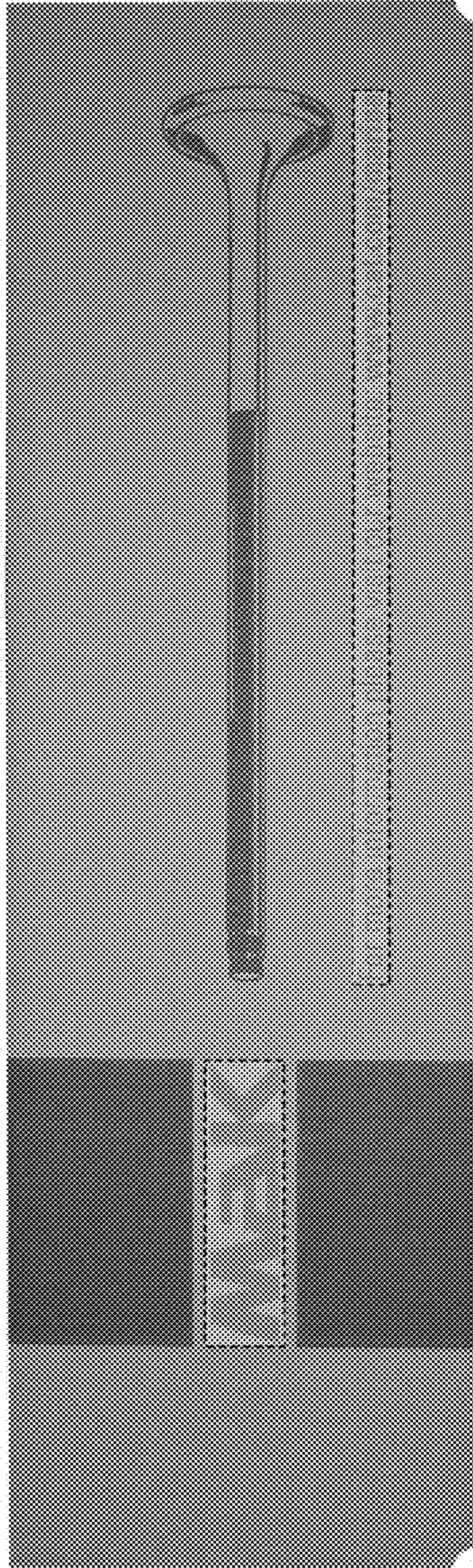

FIG. 34

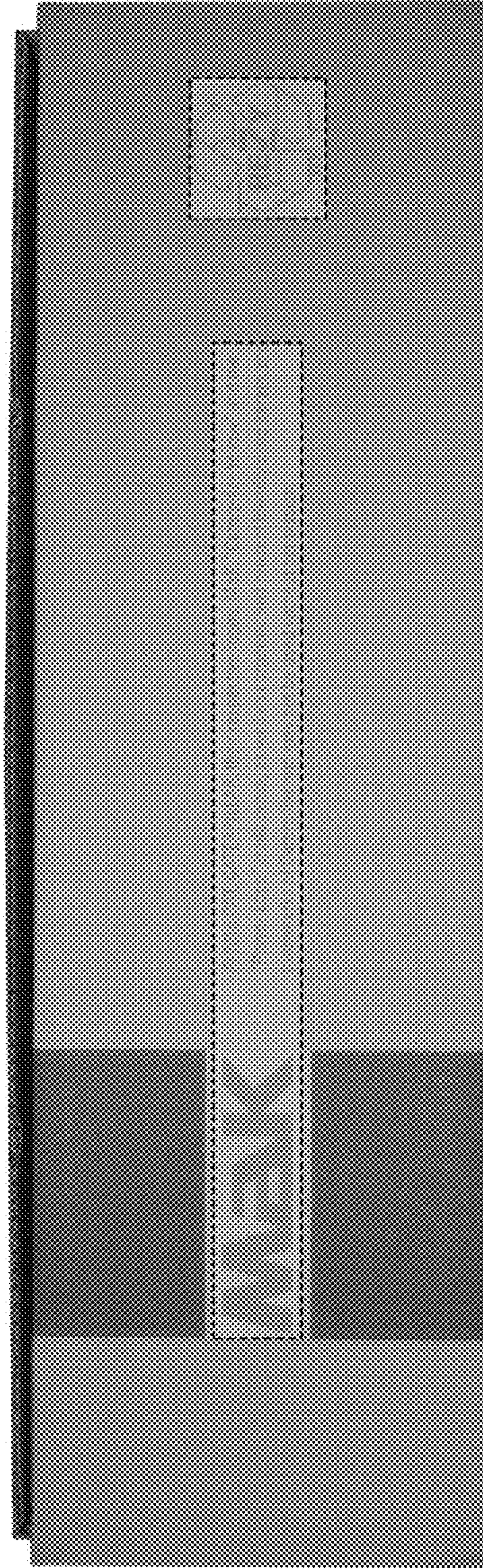

FIG. 35



FIG. 36

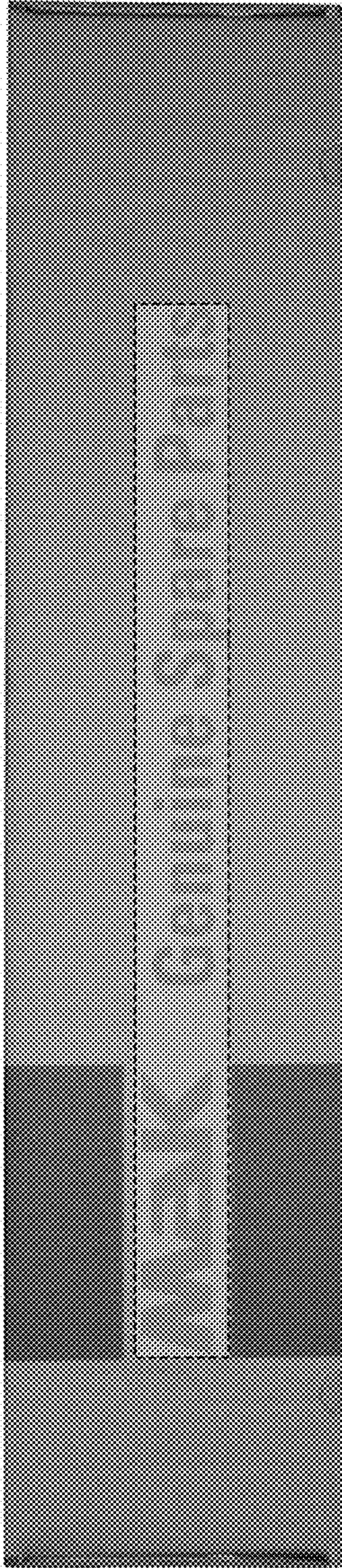

FIG. 37

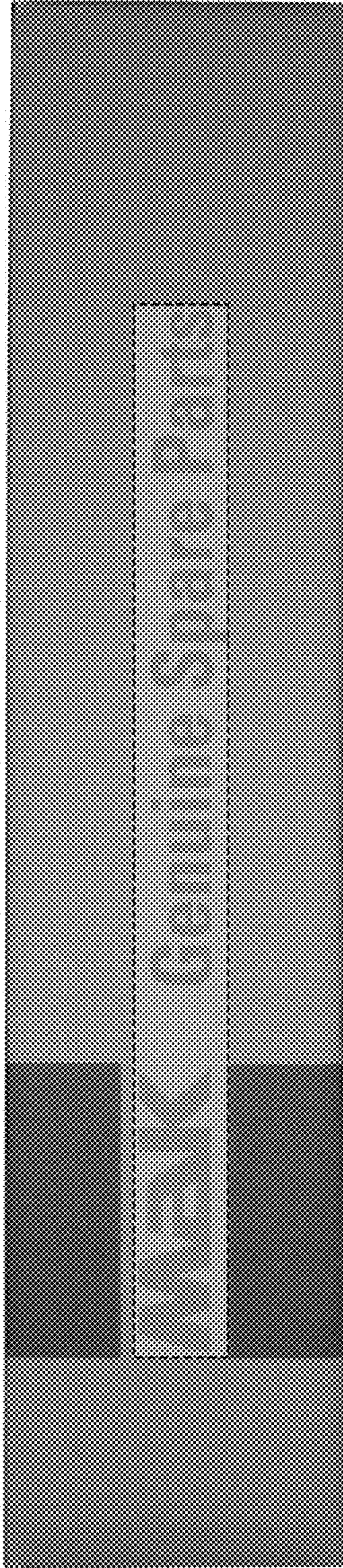

FIG. 38



FIG. 39

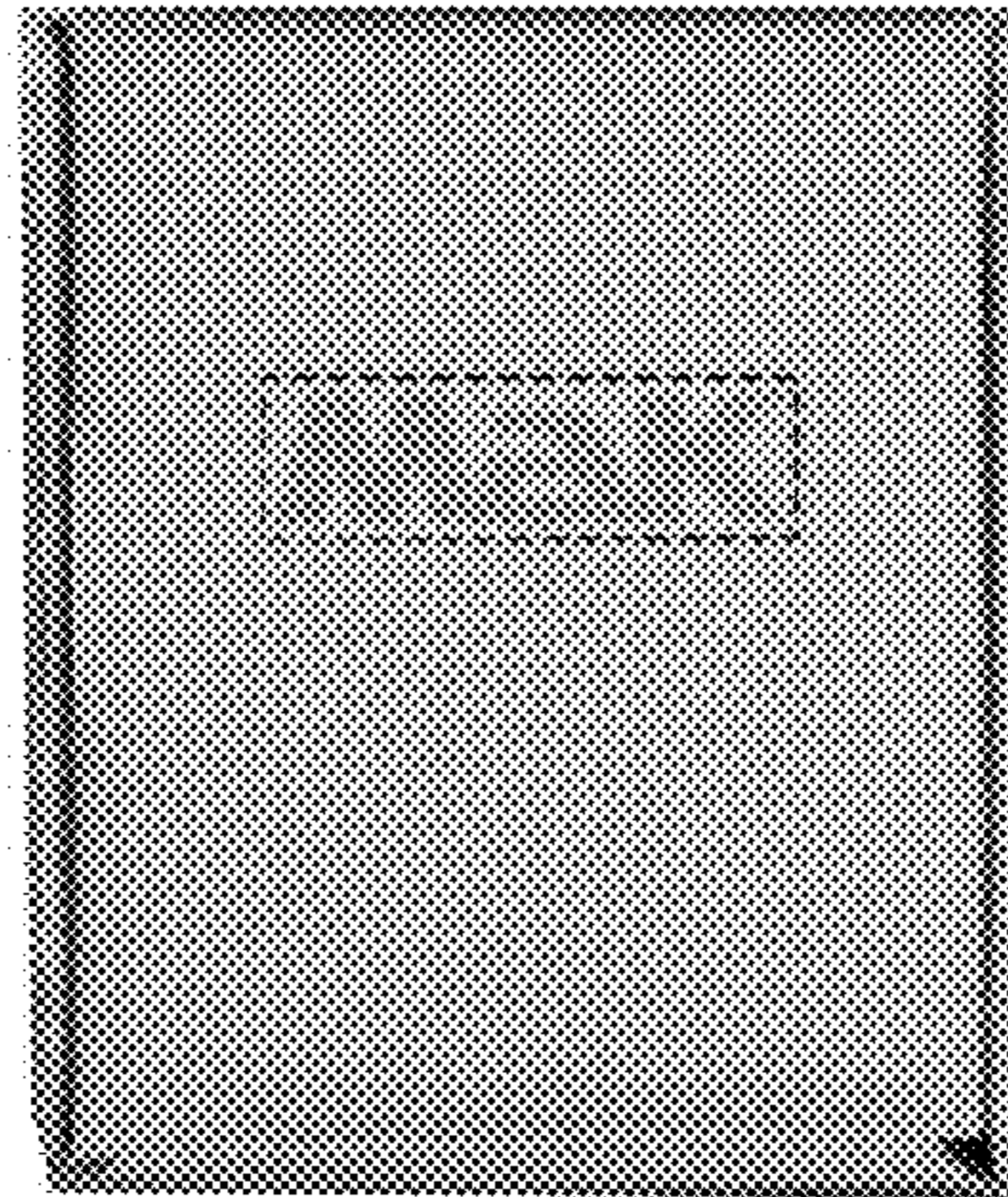

FIG. 40

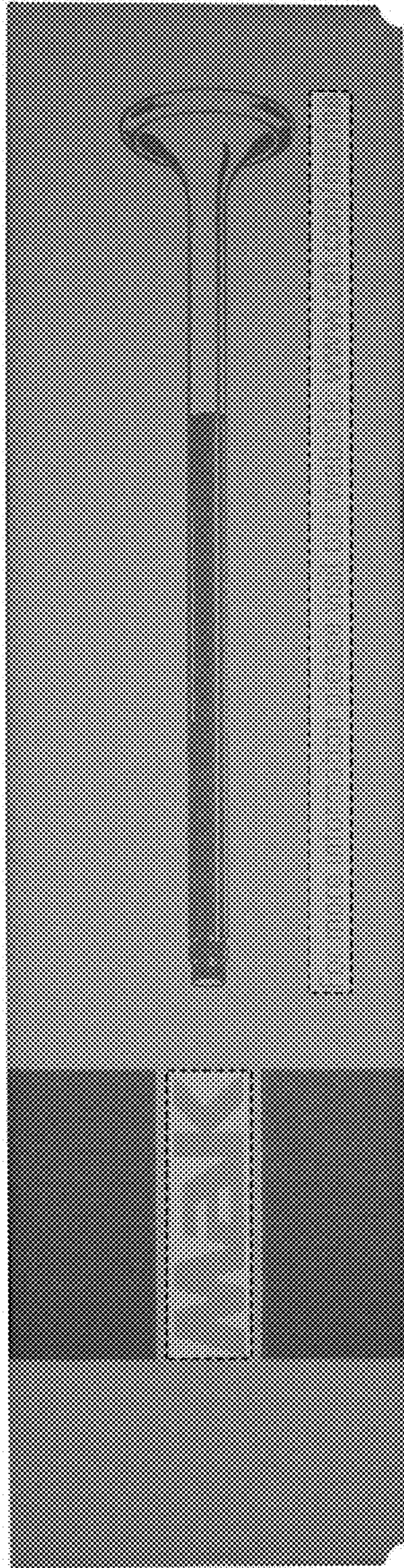

FIG. 41

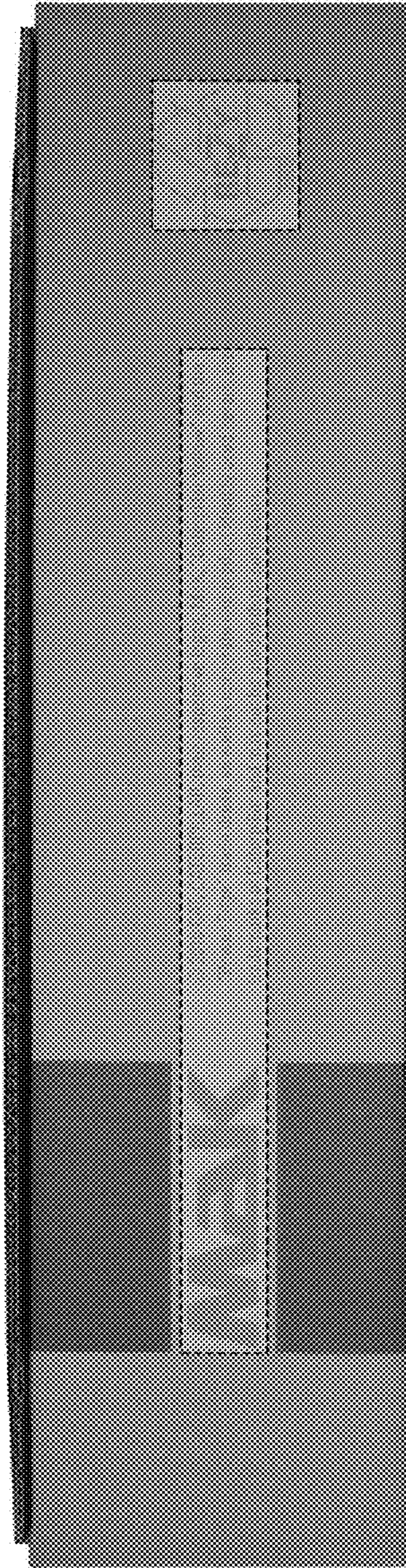

FIG. 42