



US00D977880S

(12) **United States Design Patent**  
**Luo**

(10) **Patent No.:** **US D977,880 S**  
(45) **Date of Patent:** **\*\* Feb. 14, 2023**

(54) **JEWELRY CABINET**

(71) Applicant: **Foshan Qianghong Yangyuan Trade Co., Ltd, Foshan (CN)**

(72) Inventor: **Canliu Luo, Foshan (CN)**

(73) Assignee: **Foshan Qianghong Yangyuan Trade Co., Ltd, Foshan (CN)**

(\*\*) Term: **15 Years**

(21) Appl. No.: **29/823,584**

(22) Filed: **Jan. 18, 2022**

(51) **LOC (14) Cl.** ..... **06-04**

(52) **U.S. Cl.**  
USPC ..... **D6/664.1**

(58) **Field of Classification Search**  
USPC ..... D6/300, 308, 657, 663, 664, 664.1, 671, D6/671.1, 671.2, 671.3, 671.4; D3/294, D3/295, 903  
CPC ..... A47B 17/04; A47B 67/00; A47B 67/005; A47B 67/04; A47B 88/00; A47B 88/40; A47B 43/00; A47B 46/00; A47B 47/00; A47B 47/022; A47B 47/04; A47B 55/00; A47B 67/02; A45D 42/10; A47F 7/024; A45C 11/16

See application file for complete search history.

(56) **References Cited**

**U.S. PATENT DOCUMENTS**

D383,937 S 9/1997 Myers  
5,681,100 A \* 10/1997 Powell ..... A47B 67/005 312/226  
D402,133 S \* 12/1998 Anderson ..... D6/657  
D528,840 S 9/2006 Greiner  
D601,798 S \* 10/2009 Hsu ..... D3/903  
D637,012 S 5/2011 Lu

D707,989 S \* 7/2014 Bezborodko ..... D6/663  
D707,990 S \* 7/2014 Bezborodko ..... D6/663  
D712,686 S \* 9/2014 Day ..... D6/663  
9,723,904 B1 \* 8/2017 Taylor ..... A47B 96/20  
D799,245 S \* 10/2017 Bezborordko ..... D6/663  
D808,193 S 1/2018 Sun  
D863,838 S \* 10/2019 Song ..... D6/664.1  
D882,990 S 5/2020 Song

**OTHER PUBLICATIONS**

Kasibie Full Length Mirror Jewelry Cabinet 360° Swivel, Standing Mirror With Jewelry Storage, Lockable Jewelry Organizer (White), shopabunda.com, Date First Avialable: Dec. 24, 2021, pp. 1-7, from <https://www.shopabunda.com/products/kasibie-full-length-mirror-jewelry-cabinet-360-swivel-standing-mirror-with-jewelry-storage-lockable-jewelry-organizer-white> (Year: 2021).\*

(Continued)

*Primary Examiner* — Mimoso De

(74) *Attorney, Agent, or Firm* — Nitin Kaushik

(57) **CLAIM**

The ornamental design for a jewelry cabinet, as shown and described.

**DESCRIPTION**

FIG. 1 is a top, front, and right perspective view of a jewelry cabinet in an open state showing my new design;  
FIG. 2 is a top, front, and right perspective view thereof in a close state;  
FIG. 3 is a top, rear, and left perspective view thereof in the close state;  
FIG. 4 is a front elevational view thereof in the close state;  
FIG. 5 is a right elevational view thereof in the close state;  
FIG. 6 is a left elevational view thereof in the close state;  
FIG. 7 is a top plan view thereof in the close state; and,  
FIG. 8 is a bottom plan view thereof in the close state.

**1 Claim, 8 Drawing Sheets**

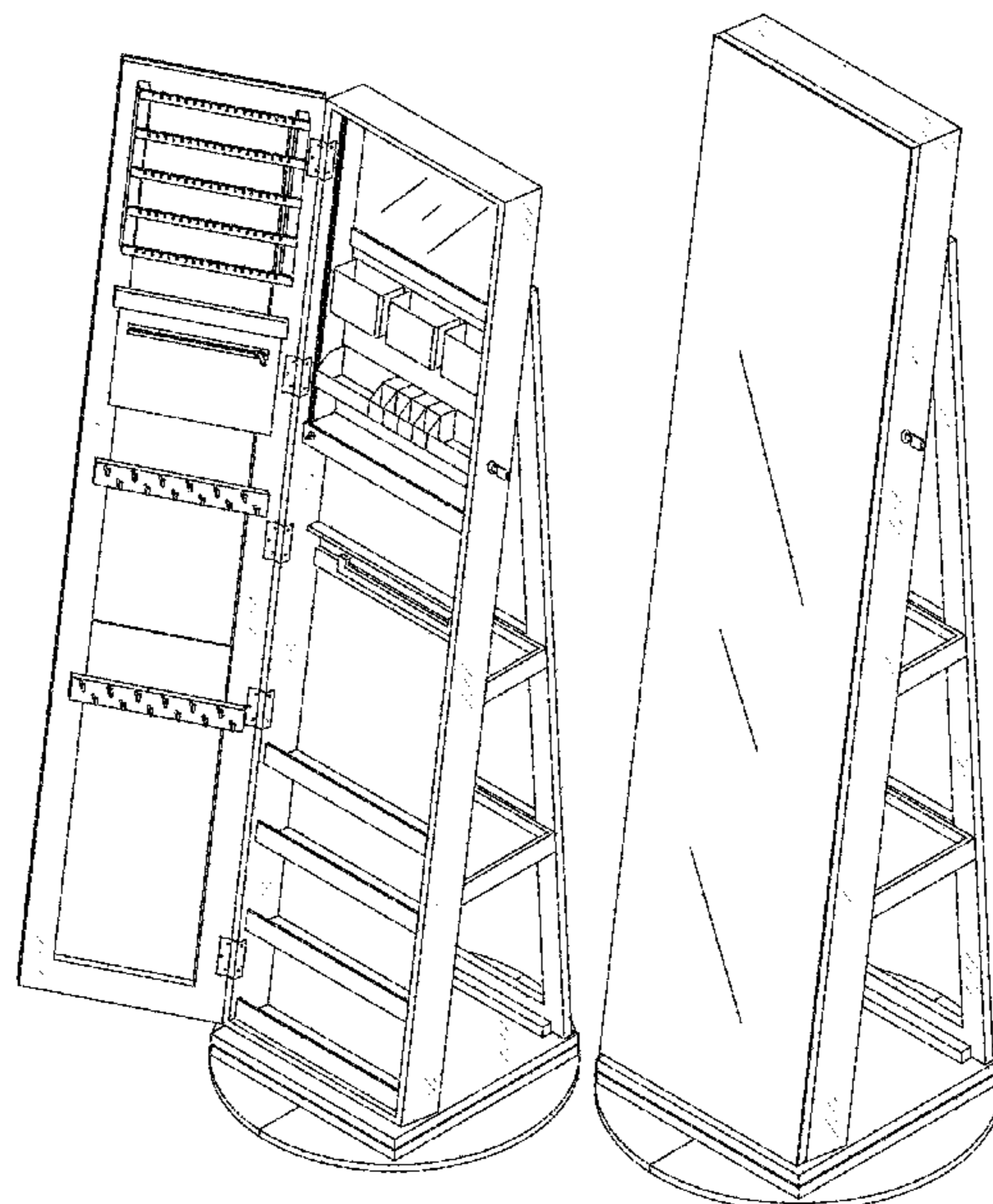

(56)

**References Cited**

OTHER PUBLICATIONS

Charmaid 360° Rotating Jewelry Armoire with Higher Full Length Mirror, [www.amazon.com](http://www.amazon.com): Charmaid Store, Retrieved Jan. 13, 2022.

Songmics Swivel Jewelry Cabinet, [www.amazone.com](http://www.amazone.com): Songmics Store, Retrieved Jan. 13, 2022.

Hysache 360 Rotating Mirrored Jewelry Cabinet, [www.amazone.com](http://www.amazone.com) brand: Hysache, Retrieved Jan. 13, 2022.

360 Rotating Jewelry Stand Organizer, [www.amazone.com](http://www.amazone.com): Serwall Store, Retrieved Jan. 13, 2022.

\* cited by examiner

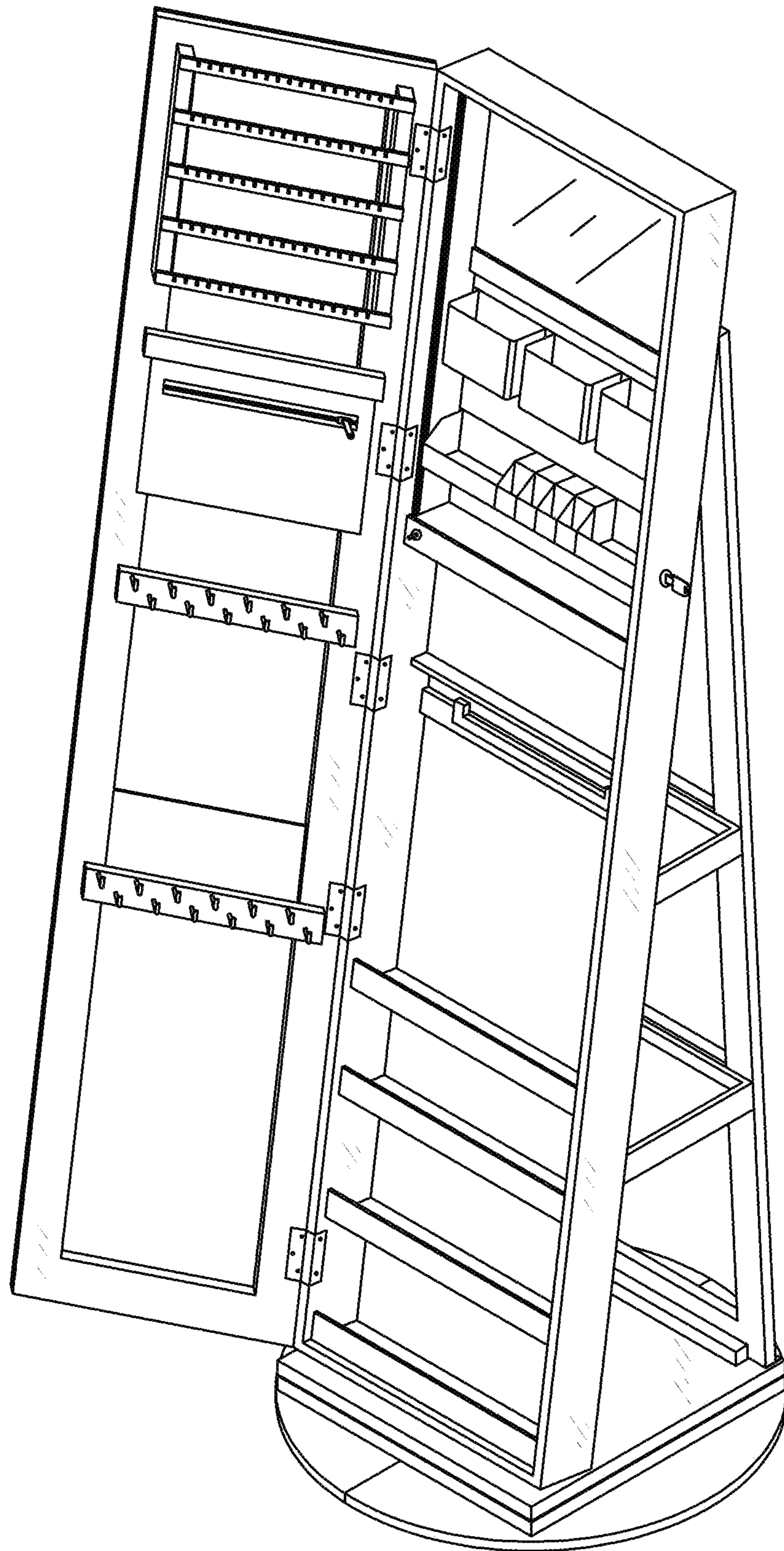

FIG. 1

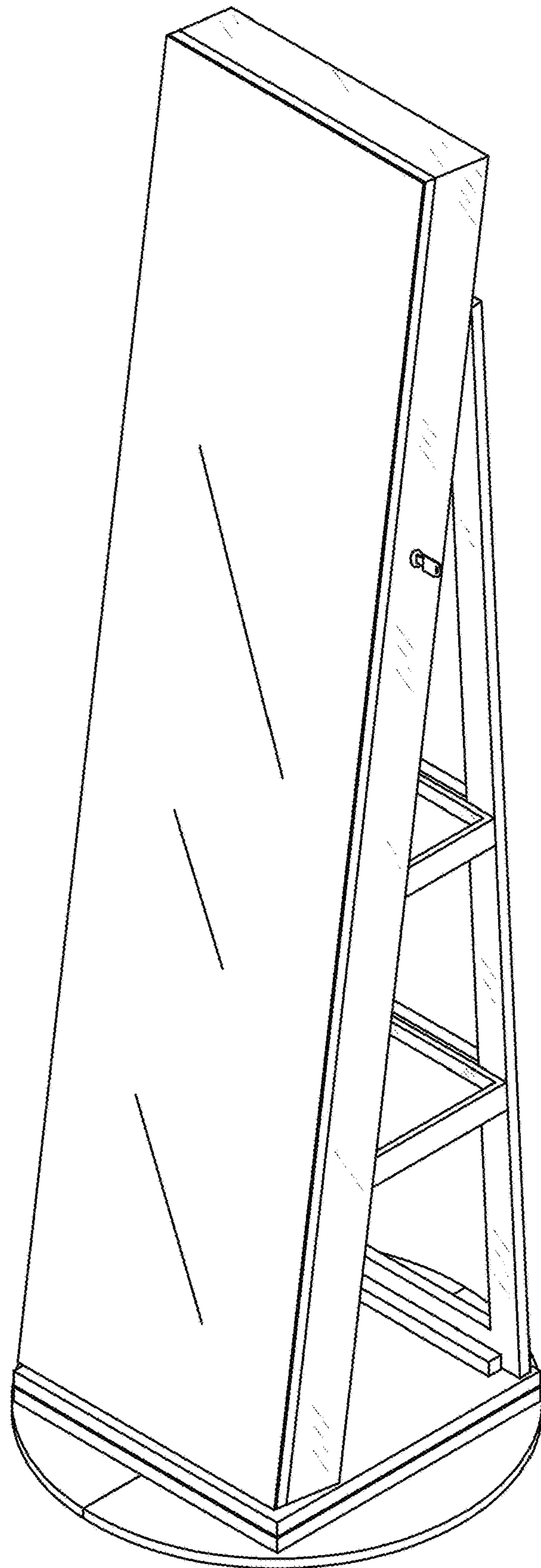

FIG. 2

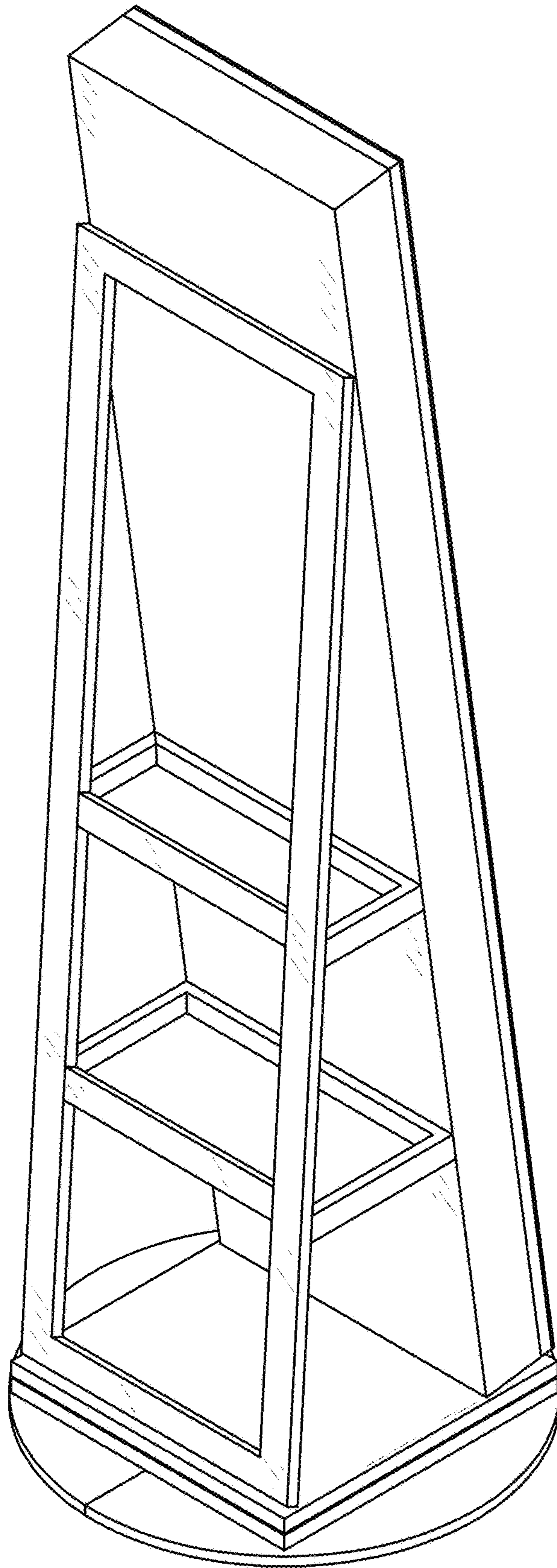

FIG. 3

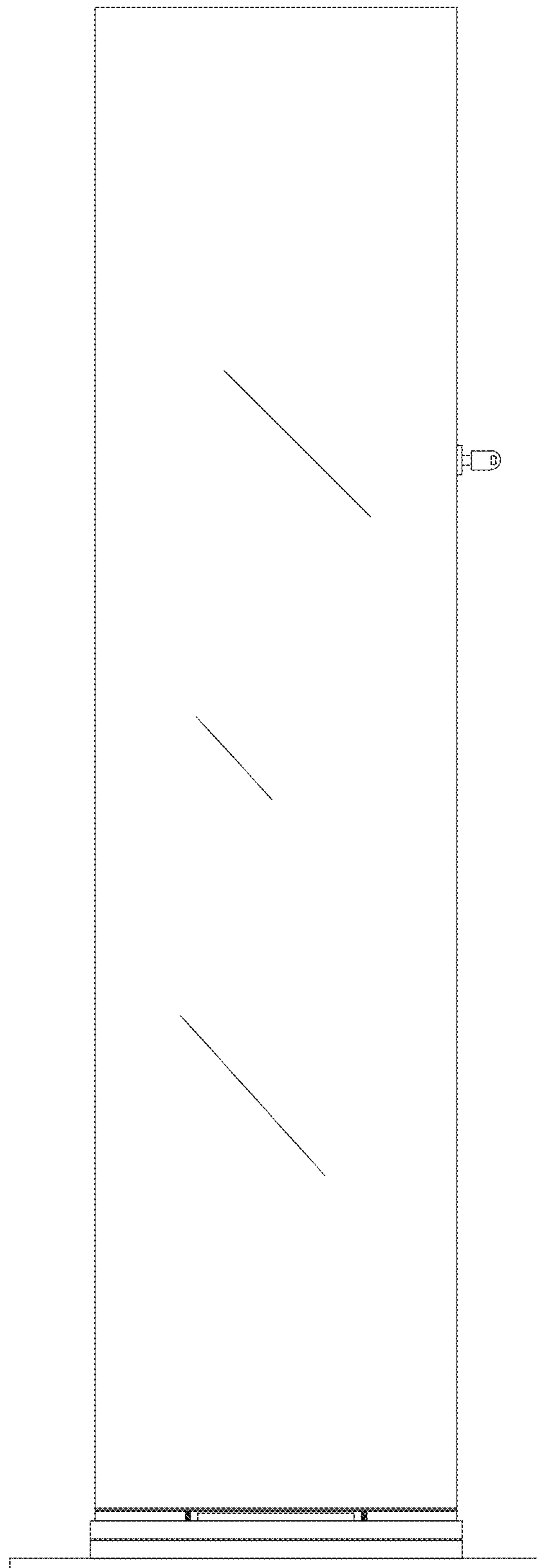

FIG. 4

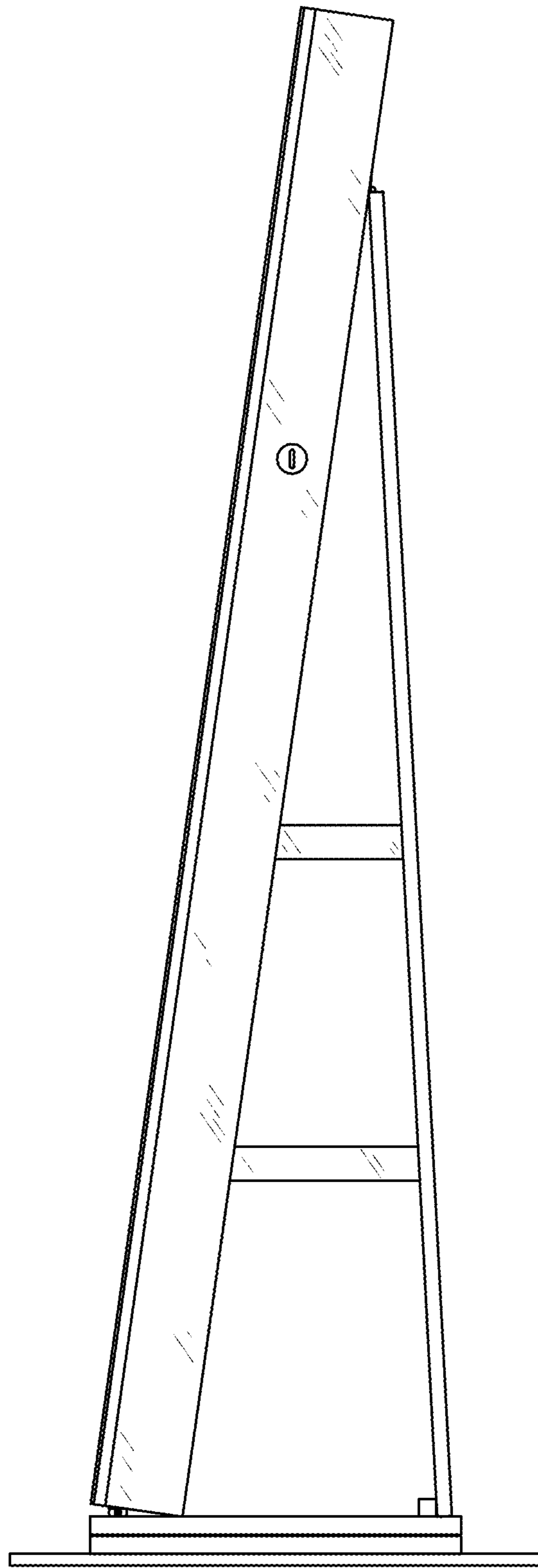

FIG. 5

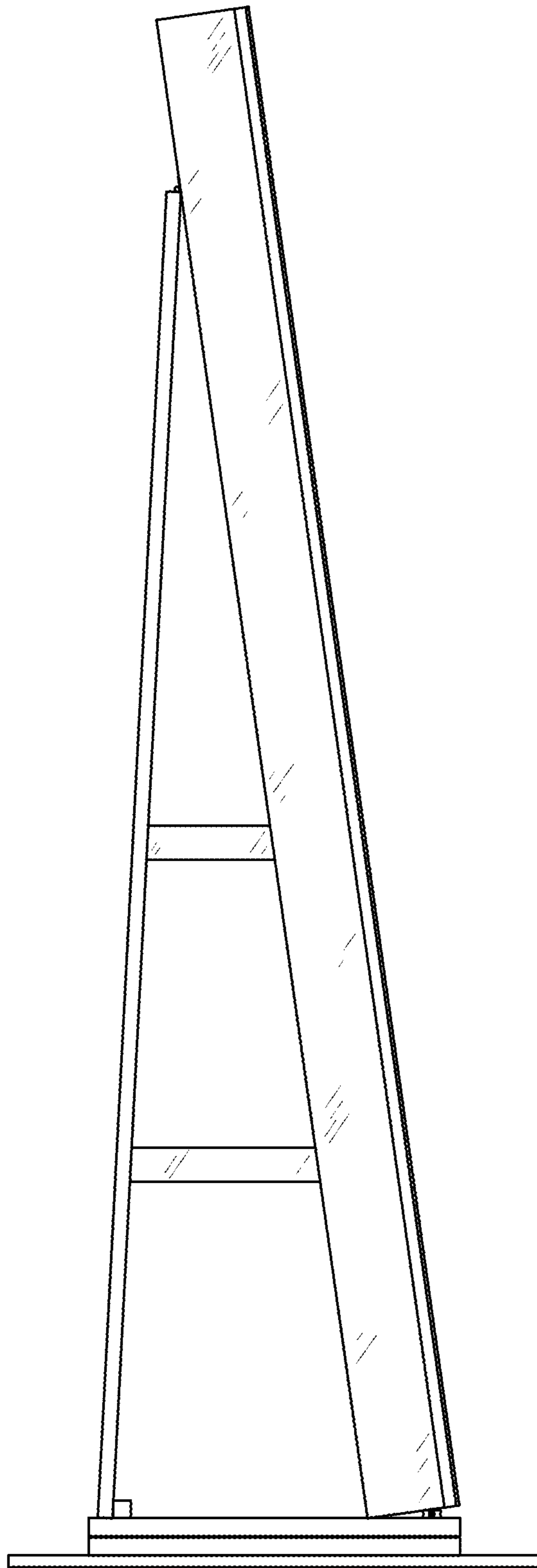

FIG. 6



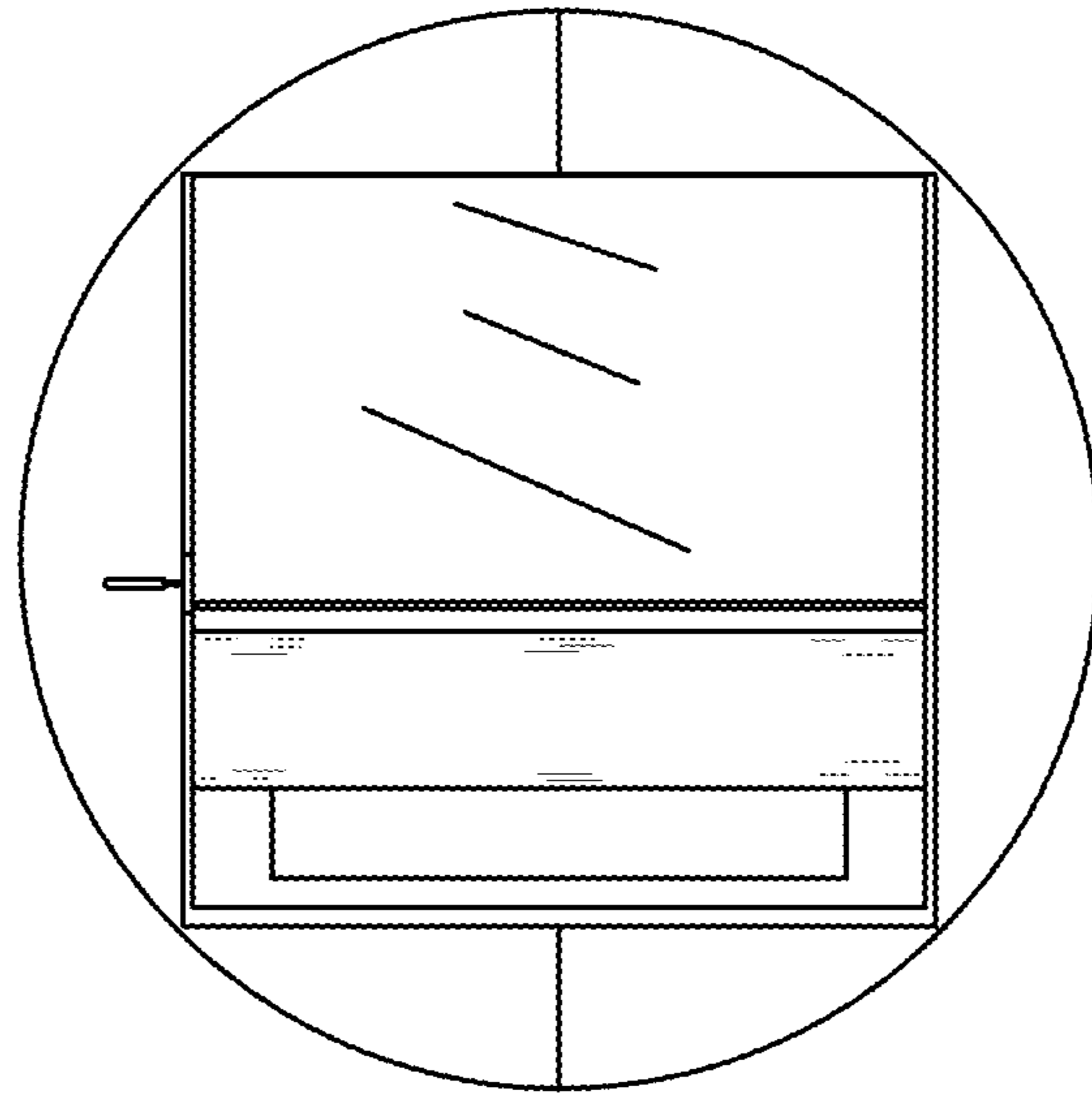

FIG. 7

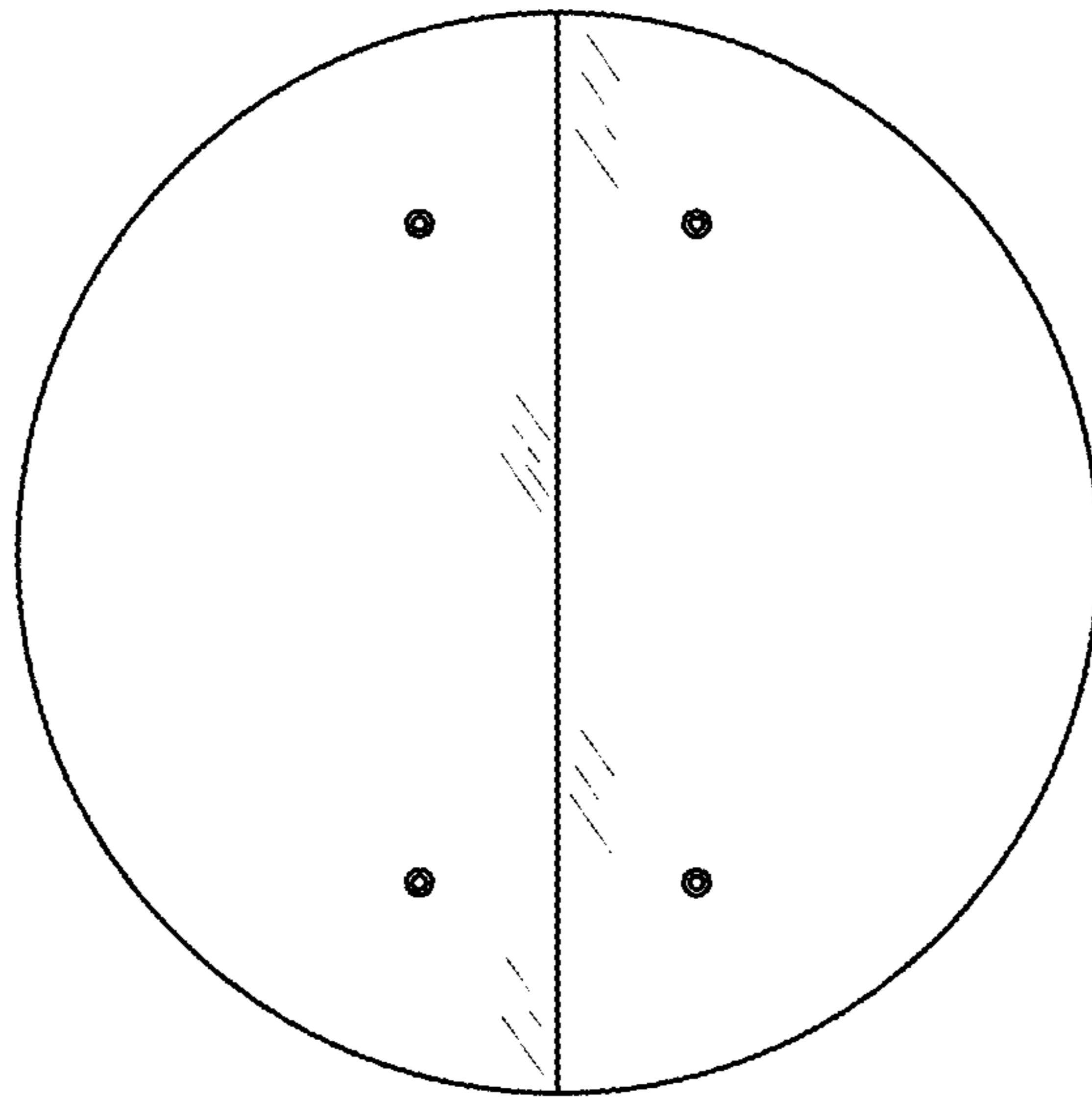

FIG. 8