

US00D977877S

(12) **United States Design Patent** (10) **Patent No.:** **US D977,877 S**  
**Chang** (45) **Date of Patent:** **\*\* Feb. 14, 2023**

(54) **INFLATABLE SLEEPING MAT**  
(71) Applicant: **Hsiu-Ming Chang**, Tainan (TW)  
(72) Inventor: **Hsiu-Ming Chang**, Tainan (TW)  
(\*\*) Term: **15 Years**  
(21) Appl. No.: **29/762,972**  
(22) Filed: **Dec. 19, 2020**  
(51) **LOC (14) Cl.** ..... **06-09**  
(52) **U.S. Cl.**  
USPC ..... **D6/604**  
(58) **Field of Classification Search**  
USPC ..... D6/549, 361, 393, 394, 601, 604, 716.5;  
D21/809  
CPC ..... A47C 27/084; A47C 17/64; A47C 31/105;  
A47C 4/54; A47C 31/123  
See application file for complete search history.

D931,014 S \* 9/2021 Shi ..... D6/604  
D938,762 S \* 12/2021 Li ..... D6/604  
D942,778 S \* 2/2022 Song ..... D6/604  
D959,878 S \* 8/2022 Meng ..... D6/604

**OTHER PUBLICATIONS**

Trekology Self Inflating Camping Mat, available in Amazon.co.uk, date first available Apr. 8, 2021 [online], Retrieved on Oct. 4, 2022 from URL: <https://www.amazon.co.uk/dp/B08NH7Y5VL/> (Year: 2021).\*

\* cited by examiner

*Primary Examiner* — Vy N Koenig  
*Assistant Examiner* — Michelle M Reeves

(57) **CLAIM**

The ornamental design for an inflatable sleeping mat, as shown and described.

**DESCRIPTION**

FIG. 1 is a perspective view of an inflatable sleeping mat showing my new design;  
FIG. 2 is a front elevational view thereof;  
FIG. 3 is a rear elevational view thereof;  
FIG. 4 is a left side elevational view thereof;  
FIG. 5 is a right side elevational view thereof;  
FIG. 6 is a top plan view thereof; and,  
FIG. 7 is a bottom plan view thereof.  
The broken lines showing an air inlet valve, label, and other features in FIGS. 1, 2, 4, 6 and 7 depict environmental subject matter and form no part of the claimed design.

**1 Claim, 7 Drawing Sheets**

(56) **References Cited**

**U.S. PATENT DOCUMENTS**

2,372,218 A \* 3/1945 Manson ..... A47C 27/081  
92/92  
D300,194 S \* 3/1989 Walker ..... D6/605  
D309,169 S \* 7/1990 Scheurer ..... D6/382  
D310,313 S \* 9/1990 Afeyan ..... D6/604  
7,462,142 B1 \* 12/2008 Gordon ..... A63B 21/4037  
482/142  
D747,117 S \* 1/2016 Lau ..... D6/393  
D823,966 S \* 7/2018 Berenson ..... D21/809  
D883,715 S \* 5/2020 Zhu ..... D6/604  
D897,740 S \* 10/2020 Tan ..... D6/604  
D921,400 S \* 6/2021 He ..... D6/604  
D923,973 S \* 7/2021 Yuan ..... D6/604

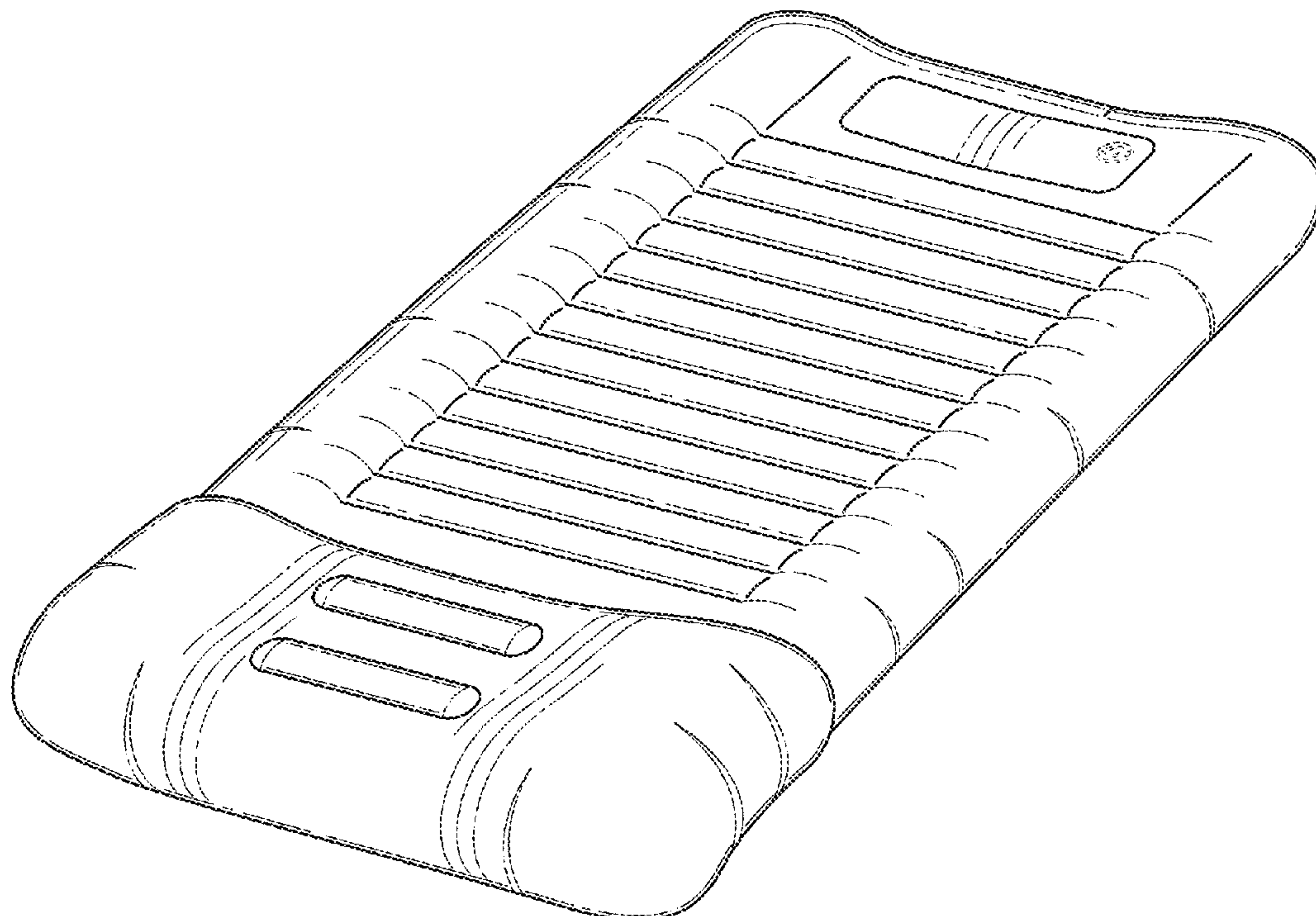

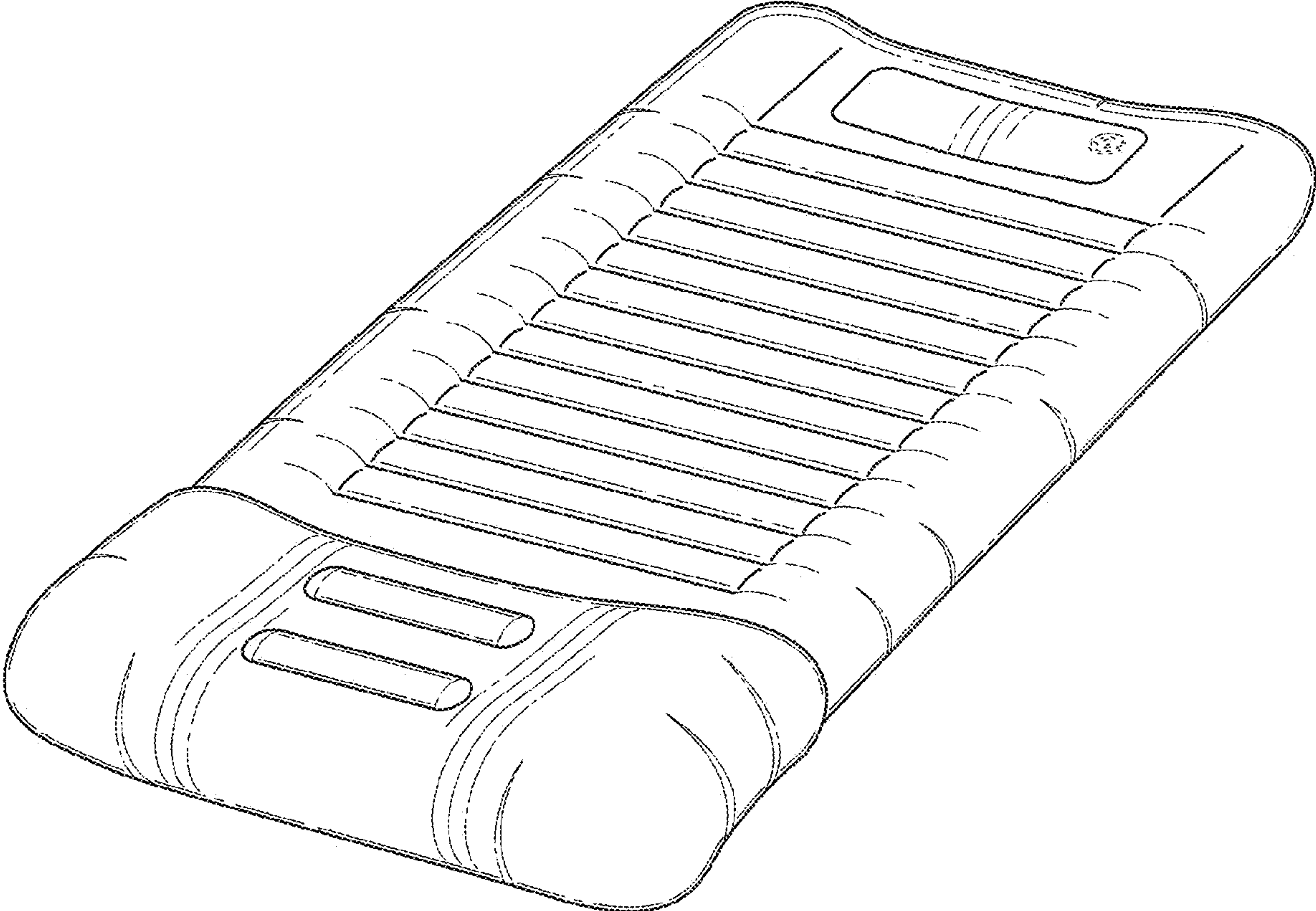

FIG. 1

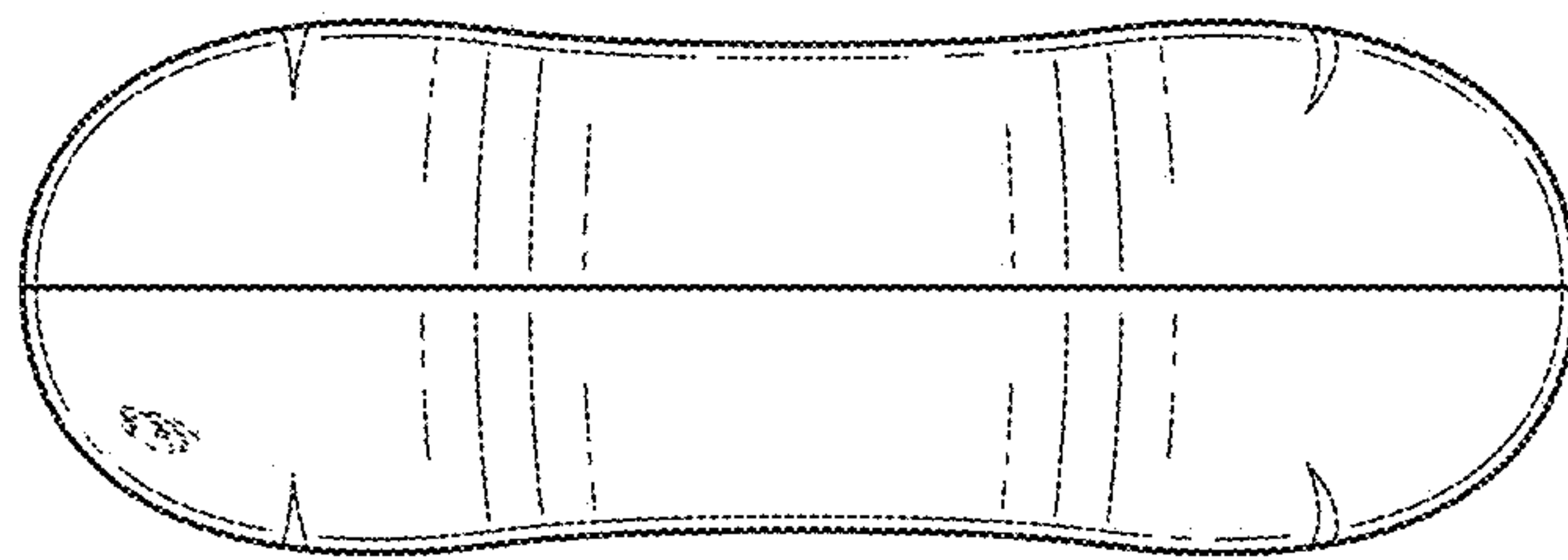

FIG. 2

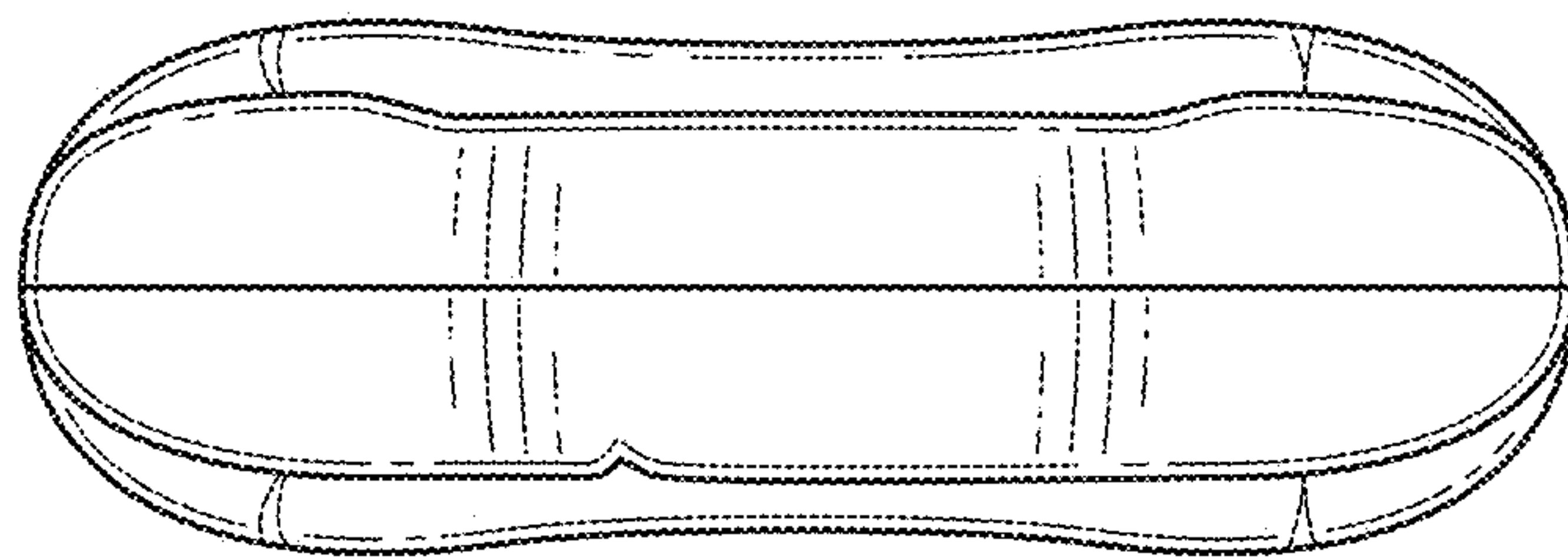

FIG. 3

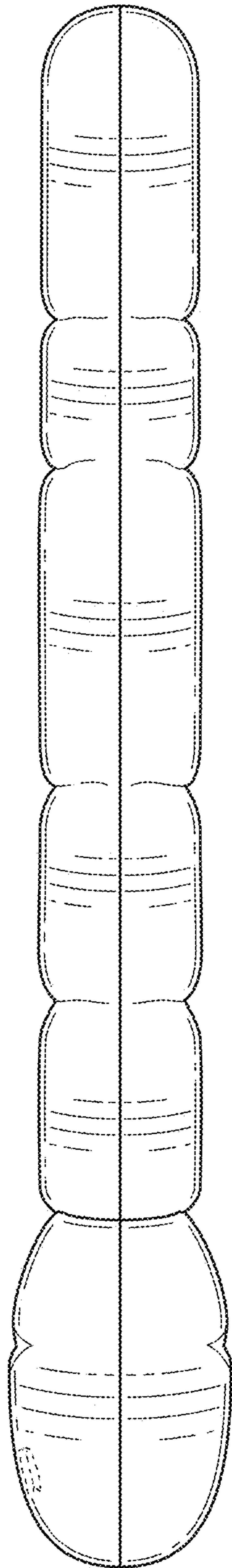

FIG. 4



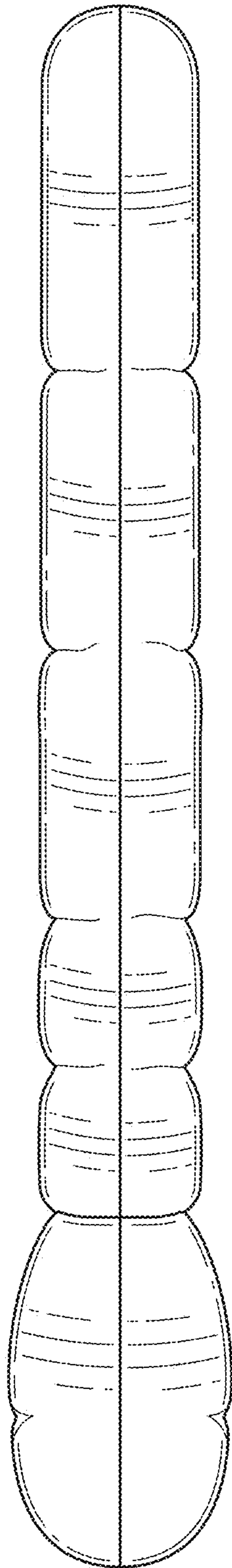

FIG. 5

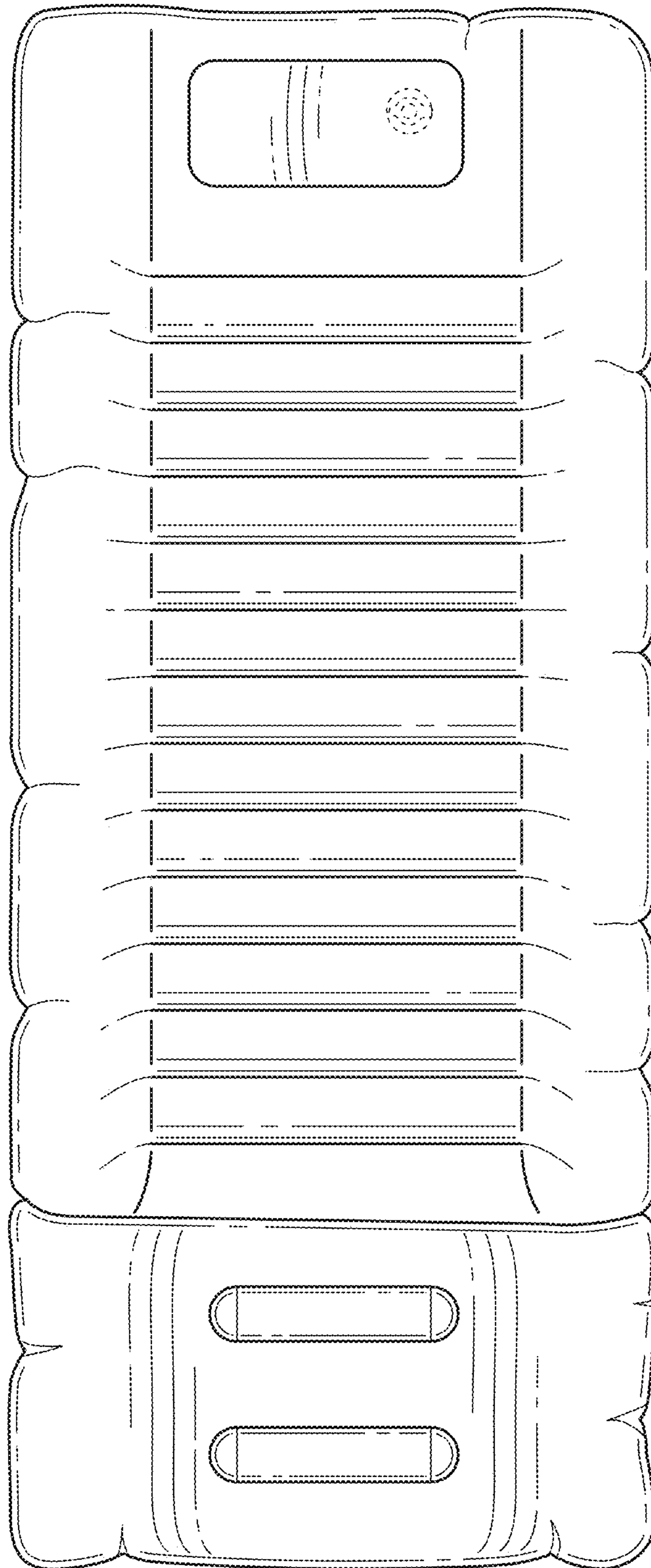

FIG. 6

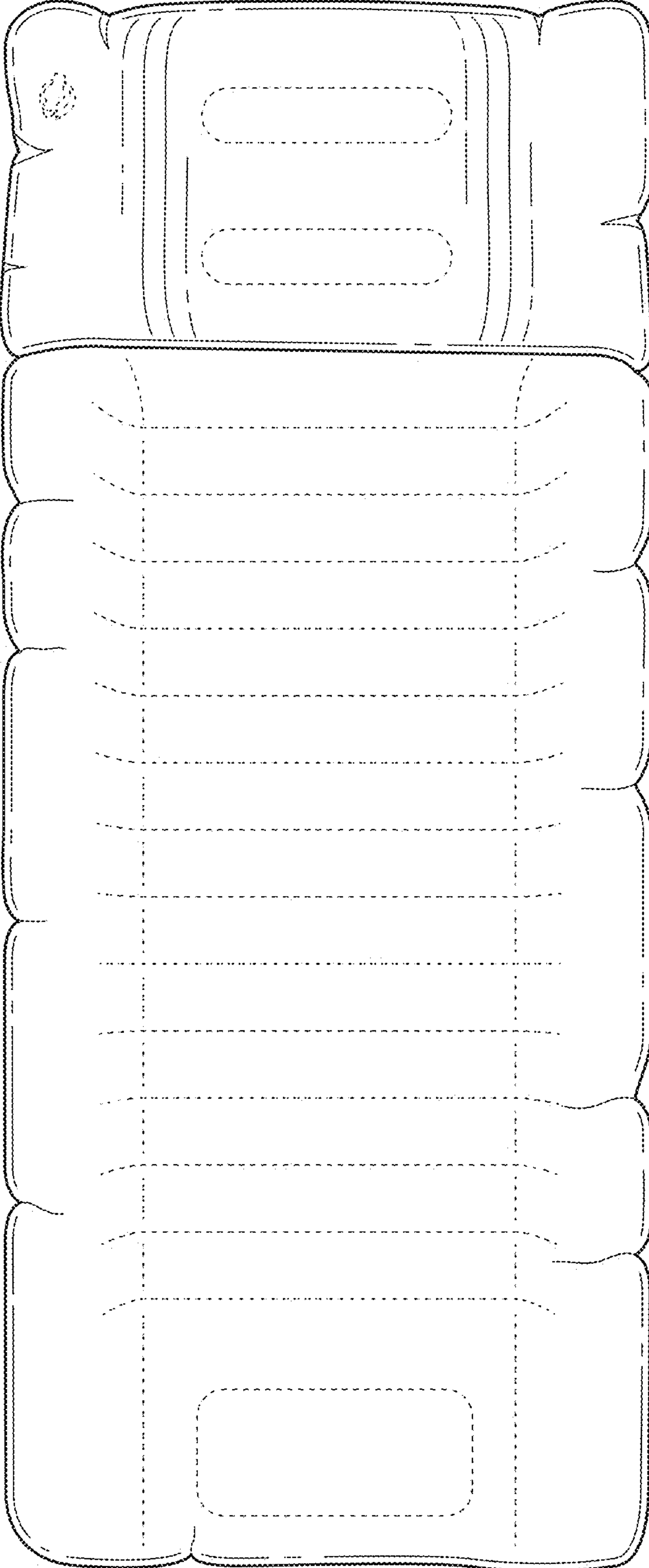

FIG. 7