



US00D977842S

(12) **United States Design Patent** (10) **Patent No.:** **US D977,842 S**
Lee (45) **Date of Patent:** **** Feb. 14, 2023**

(54) **HAIR BRUSH**

FOREIGN PATENT DOCUMENTS

(71) Applicant: **Jun Lee**, Seoul (KR)

CN 307524371 * 9/2022
EM 008286041-0001 * 12/2020

(72) Inventor: **Jun Lee**, Seoul (KR)

OTHER PUBLICATIONS

(**) Term: **15 Years**

(21) Appl. No.: **29/761,118**

Mellotory, announced 2022 [online], [site visited Oct. 3, 2022], Avail from int, URL: https://mellotory.com/shop/?idx=7#prod_detail_review (Year: 2022).*

(22) Filed: **Dec. 7, 2020**

Tangle Teezer, announced 2019 [online], [site visited Oct. 3, 2022]. Avail from int, URL: <https://www.amazon.com/dp/B01M075JTT> (Year: 2019).*

(51) **LOC (14) Cl.** **04-99**

Michael Mercier, announced 2015 [online], [site visited Oct. 3, 2022]. Avail from int, URL: <https://www.walmart.com/ip/Michel-Mercier-by-Kampalook-Detangling-Hair-Brush-Color-May-Vary/33573734> (Year: 2015).*

(52) **U.S. Cl.**

USPC **D4/134**

(58) **Field of Classification Search**

USPC D4/100, 102, 116, 117, 118, 121, 122, D4/127, 128, 130, 131, 132, 133, 134, D4/138; D28/15, 24; D30/158, 159
CPC A46B 2200/104; A46B 15/0059; A46B 15/003; A45D 24/00; A45D 2/001; A45D 20/48; A01K 13/002

* cited by examiner

See application file for complete search history.

Primary Examiner — Cynthia Ramirez

Assistant Examiner — Tamara L Hahn

(57) **CLAIM**

The ornamental design for a hair brush, as shown and described.

(56) **References Cited**

DESCRIPTION

U.S. PATENT DOCUMENTS

D509,032 S *	8/2005	Dunn	D4/138
D796,209 S *	9/2017	Hu	D28/25
D796,210 S *	9/2017	Hu	D28/25
D817,007 S *	5/2018	Guy-Rabi	A45D 7/00
				D4/100
D821,649 S *	6/2018	Qin	D28/35
10,531,727 B2 *	1/2020	Sze	A46B 7/06
D905,970 S *	12/2020	Rennette	D4/134
D941,037 S *	1/2022	Wojczak	D4/138
2009/0083919 A1 *	4/2009	Taggart	A46B 13/023
				15/186
2018/0103748 A1 *	4/2018	Sze	A46B 9/026

FIG. 1 is a perspective view of a hair brush according to the present design.

FIG. 2 is a front view of the hair brush of FIG. 1.

FIG. 3 is a back view of the hair brush of FIG. 1.

FIG. 4 is a right side the hair brush of FIG. 1.

FIG. 5 is a left side view of the hair brush of FIG. 1.

FIG. 6 is a top view of the hair brush of FIG. 1; and,

FIG. 7 is a bottom view of the hair brush of FIG. 1.

The broken lines in the figures show portions of the hair brush that form no part of the claimed design.

1 Claim, 7 Drawing Sheets

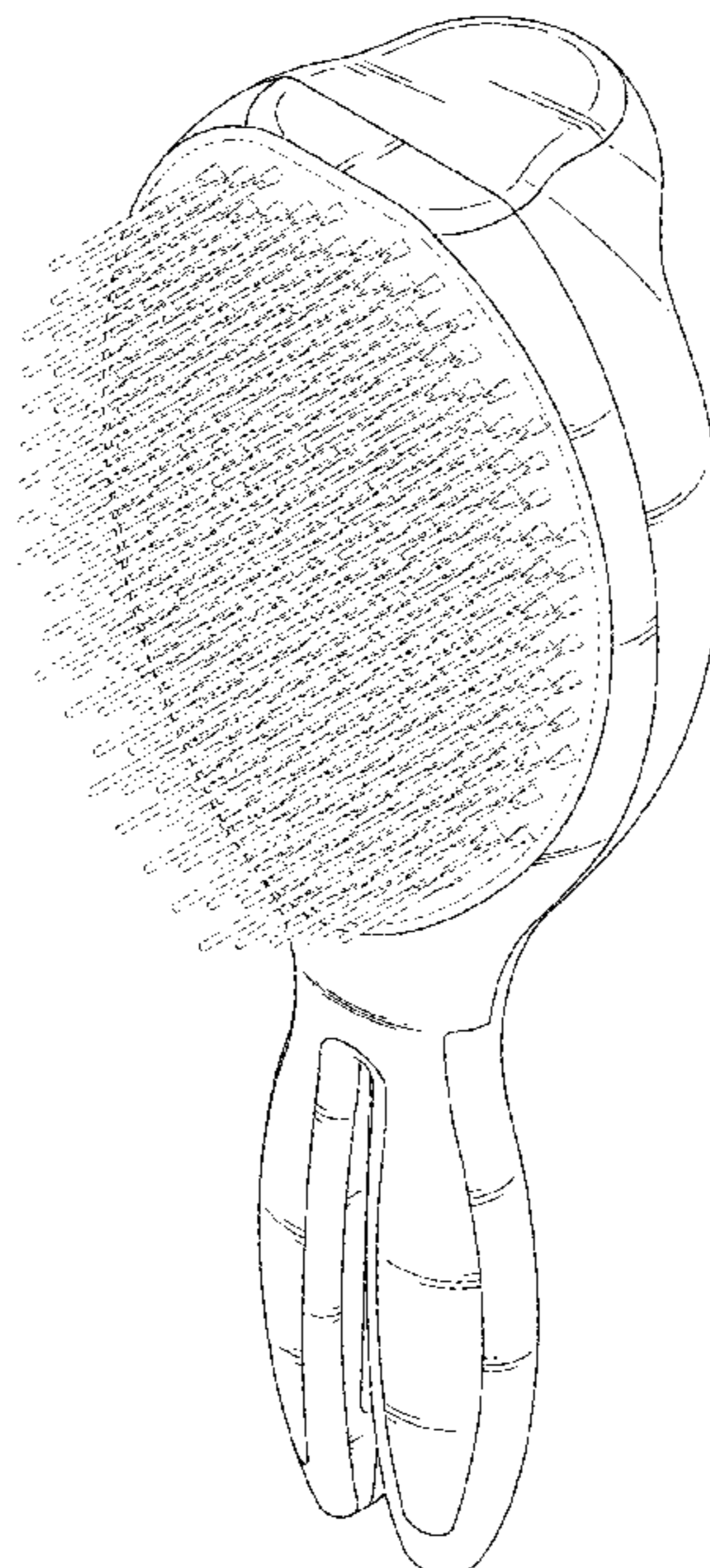

FIG. 1

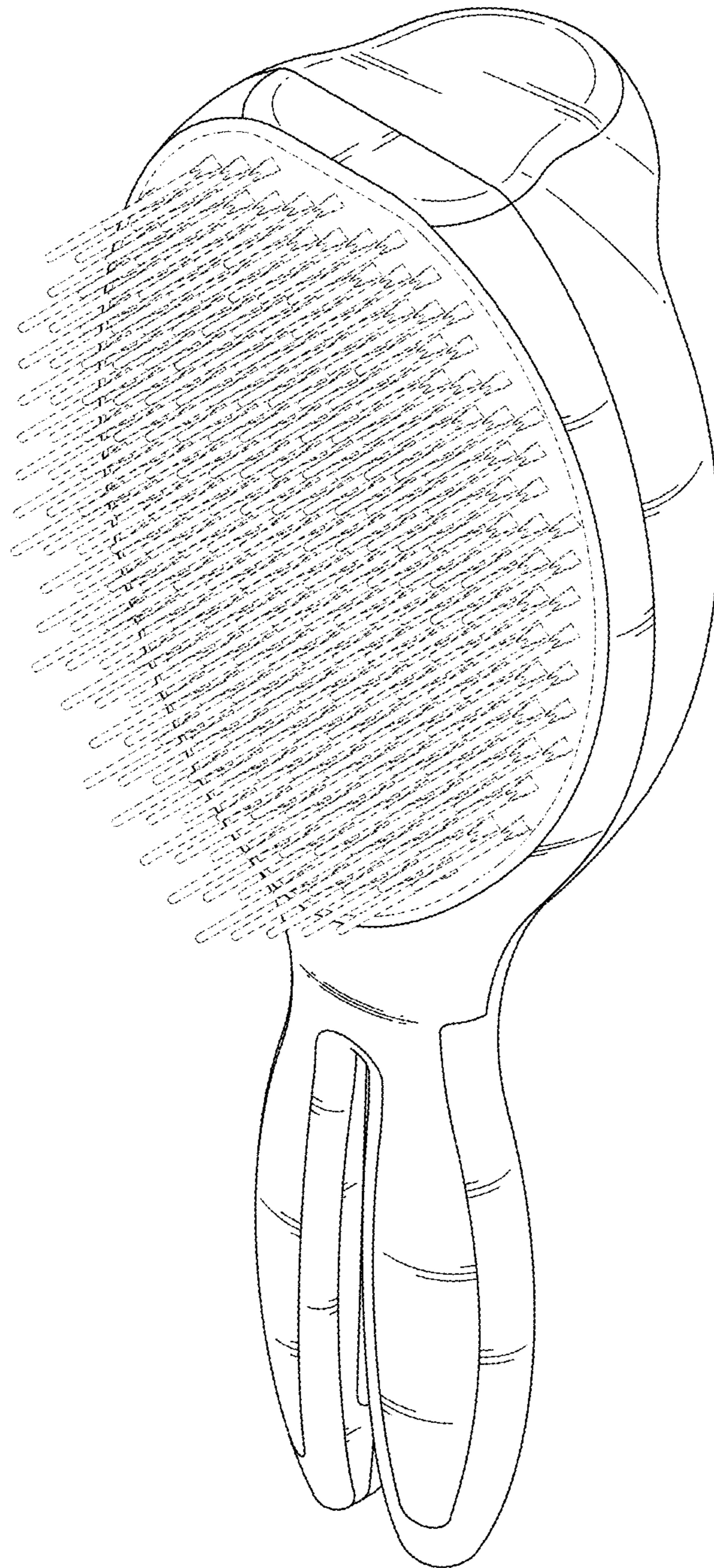

FIG. 2

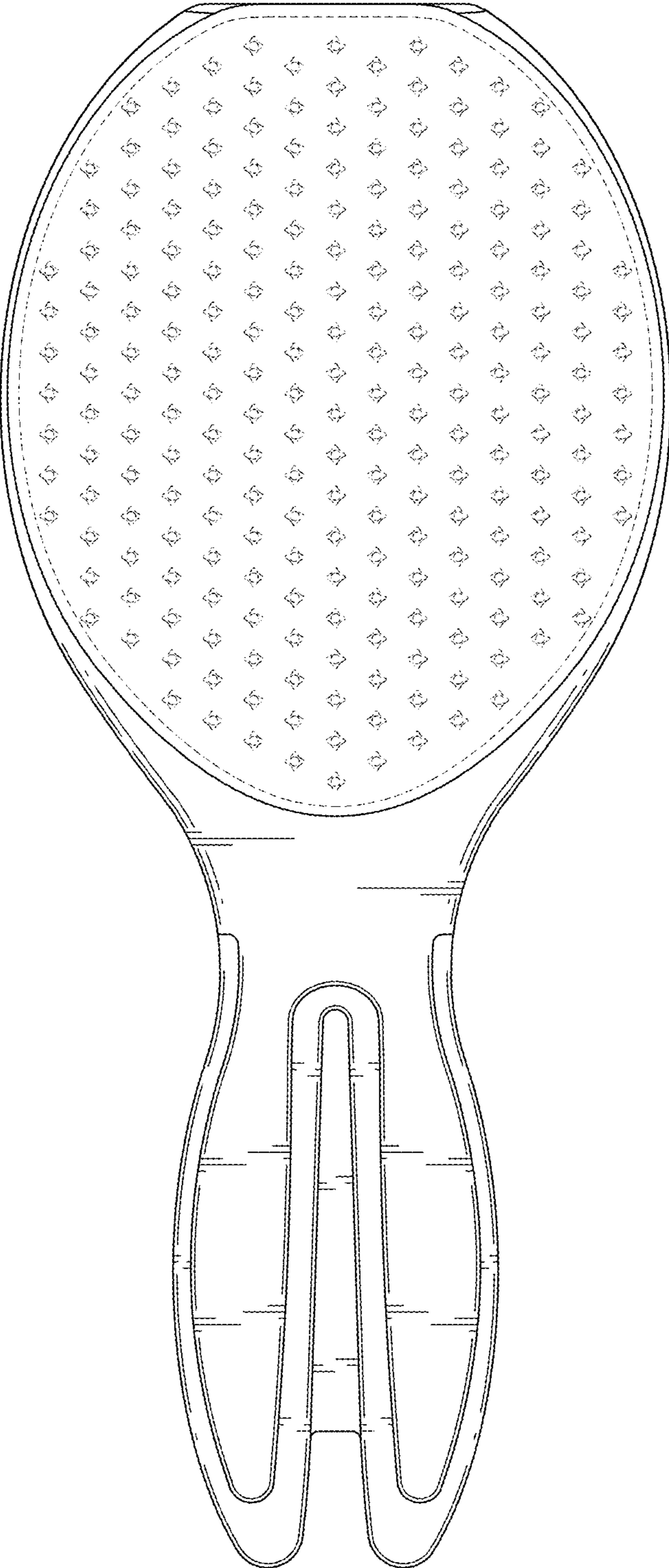

FIG. 3

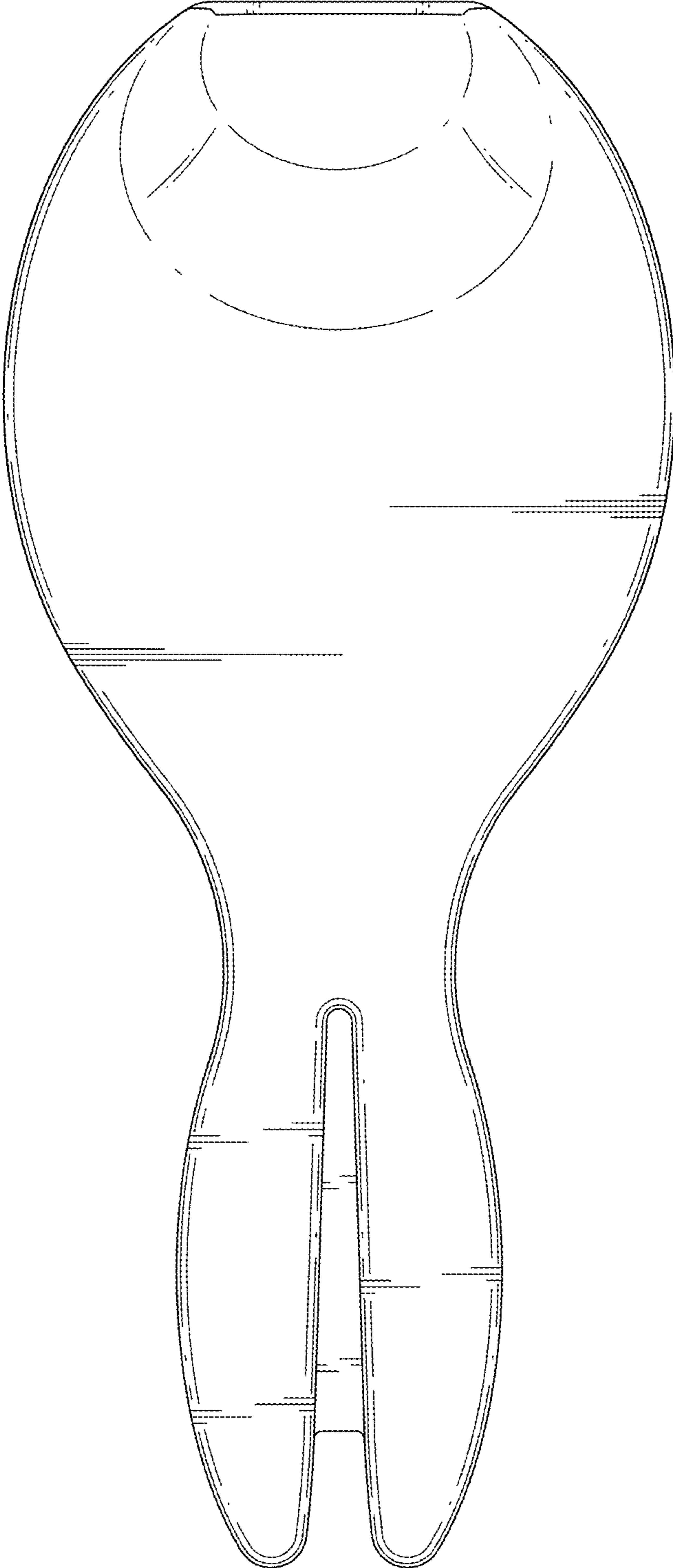

FIG. 4

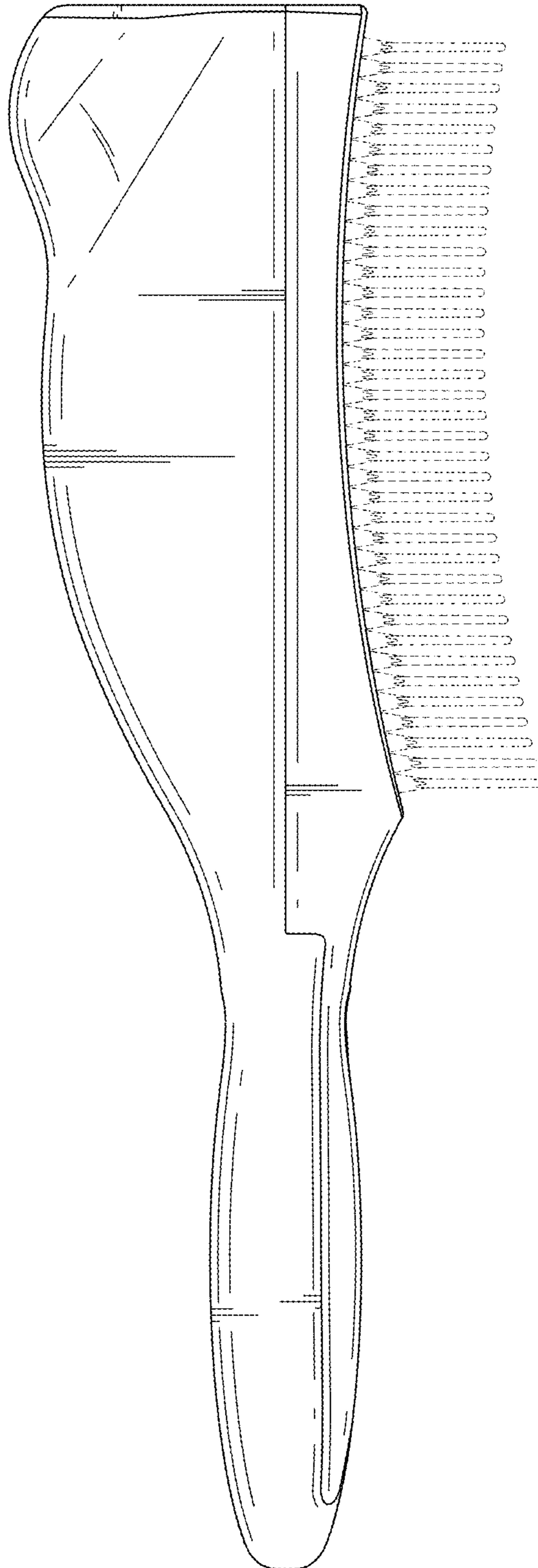

FIG. 5

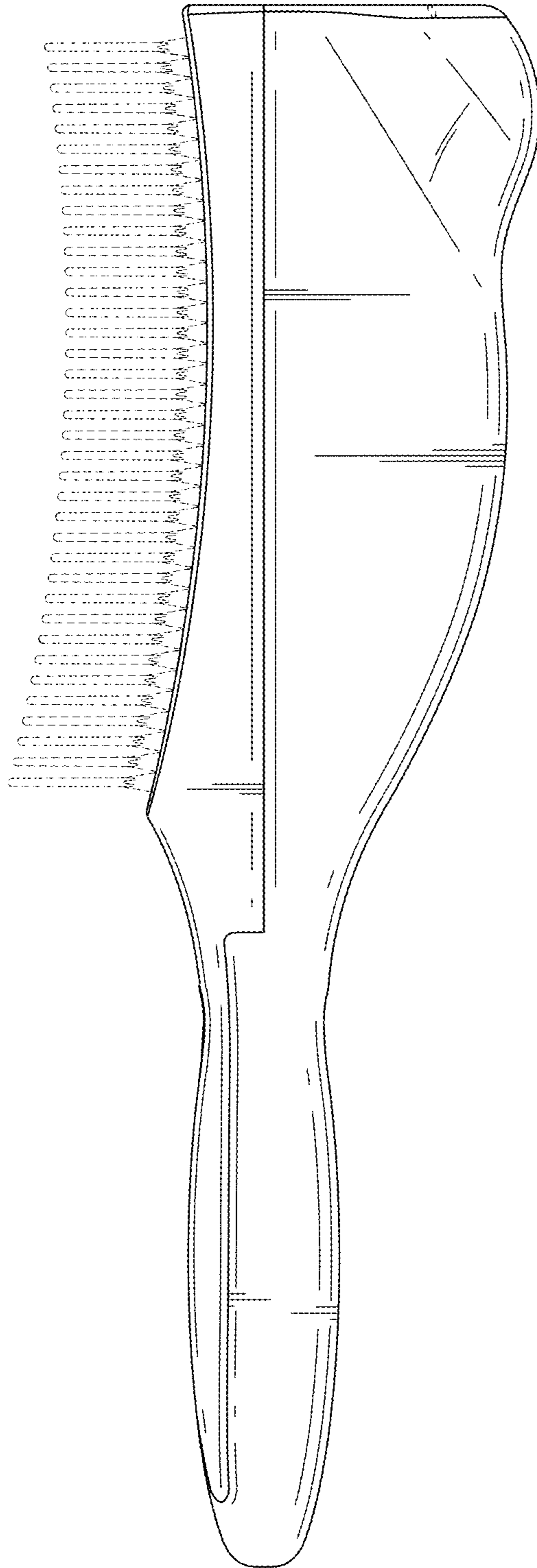

FIG. 6

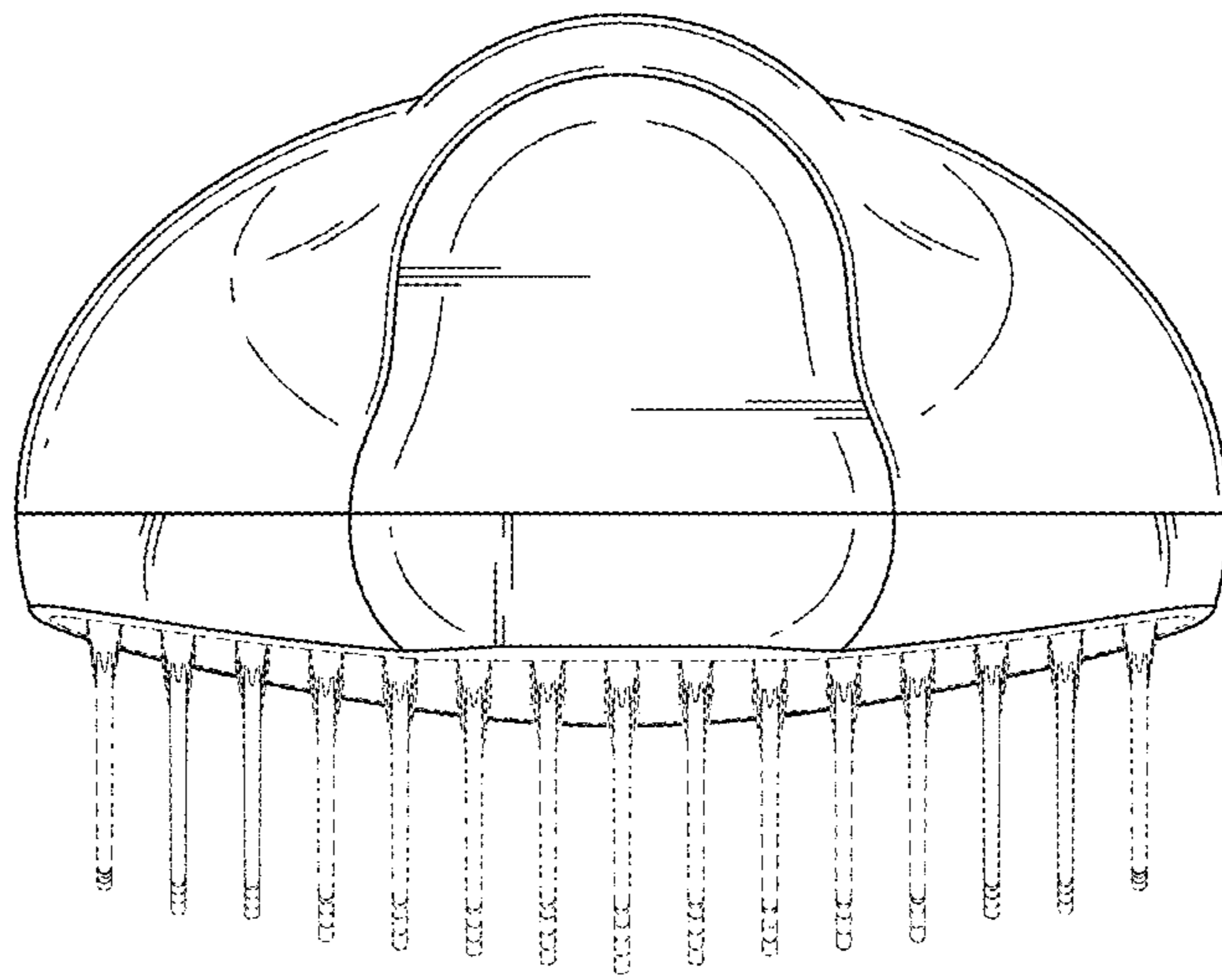

FIG. 7

