



US00D977780S

(12) **United States Design Patent** (10) **Patent No.:** **US D977,780 S**
Vásquez et al. (45) **Date of Patent:** **** Feb. 14, 2023**

(54) **WAIST TRAINER**

FOREIGN PATENT DOCUMENTS

(71) Applicant: **Diseños Tributo Colombia SAS,**
Bogota (CO)

CN 306616357 * 6/2021
CN 306789409 * 8/2021

(Continued)

(72) Inventors: **Viviana María Millán Vásquez,**
Bogota (CO); **Charly Milena Capera**
Garzón, Bogota (CO)

OTHER PUBLICATIONS

(73) Assignee: **Disenos Tributo Colombia SAS,**
Bogota (CO)

Tributo Post, available at facebook.com, posted Feb. 25, 2019
[online], site visited Nov. 12, 2021, Available from the internet
URL: <https://www.facebook.com/FajasTributo/photos/a.180924535369383/1902721479856338/?type=3> (Year: 2019).*

(**) Term: **15 Years**

(Continued)

(21) Appl. No.: **29/712,047**

Primary Examiner — Messina L Smith

(22) Filed: **Nov. 5, 2019**

Assistant Examiner — Jillian Mazzola

(51) **LOC (14) Cl.** **02-01**

(74) *Attorney, Agent, or Firm* — Bay State IP, LLC

(52) **U.S. Cl.**

(57) **CLAIM**

USPC **D2/702**

The ornamental design for a waist trainer, as shown and described.

(58) **Field of Classification Search**

DESCRIPTION

USPC D2/700–705, 712–716, 728, 731–734,
D2/741, 840–843

CPC A41C 1/00; A41C 1/003; A41C 1/006;
A41C 1/04; A41C 1/06; A41C 1/10;
A41C 1/12; A41C 1/16; A41C 1/18;
A41C 1/20

See application file for complete search history.

FIG. 1 is a front perspective view of a waist trainer showing our new design;
FIG. 2 is a front view thereof;
FIG. 3 is a back view thereof;
FIG. 4 is a left side view thereof;
FIG. 5 is a right side view thereof; and,
FIG. 6 is a top view thereof.

(56) **References Cited**

U.S. PATENT DOCUMENTS

963,026 A * 6/1910 Liebermann A41C 1/00
450/119
D56,626 S * 11/1920 Rubin D2/731
D164,330 S * 8/1951 Rosenfeld et al. D2/704
2,565,866 A * 8/1951 Loftus A41C 1/003
450/99
2,569,229 A * 9/1951 Cooper A41C 1/003
450/99
D201,881 S * 8/1965 Krieger D2/704
D546,029 S * 7/2007 Rindle D2/738

The thicker dash-dash broken lines shown in the drawings depict portions of the waist trainer that form no part of the claim design.

The thinner dash-dash broken lines shown in the drawings depict portions of the waist trainer that form no part of the claim design.

The dot-dash broken lines shown in the drawings depict boundaries of the claim that form no part of the claimed design.

(Continued)

1 Claim, 6 Drawing Sheets

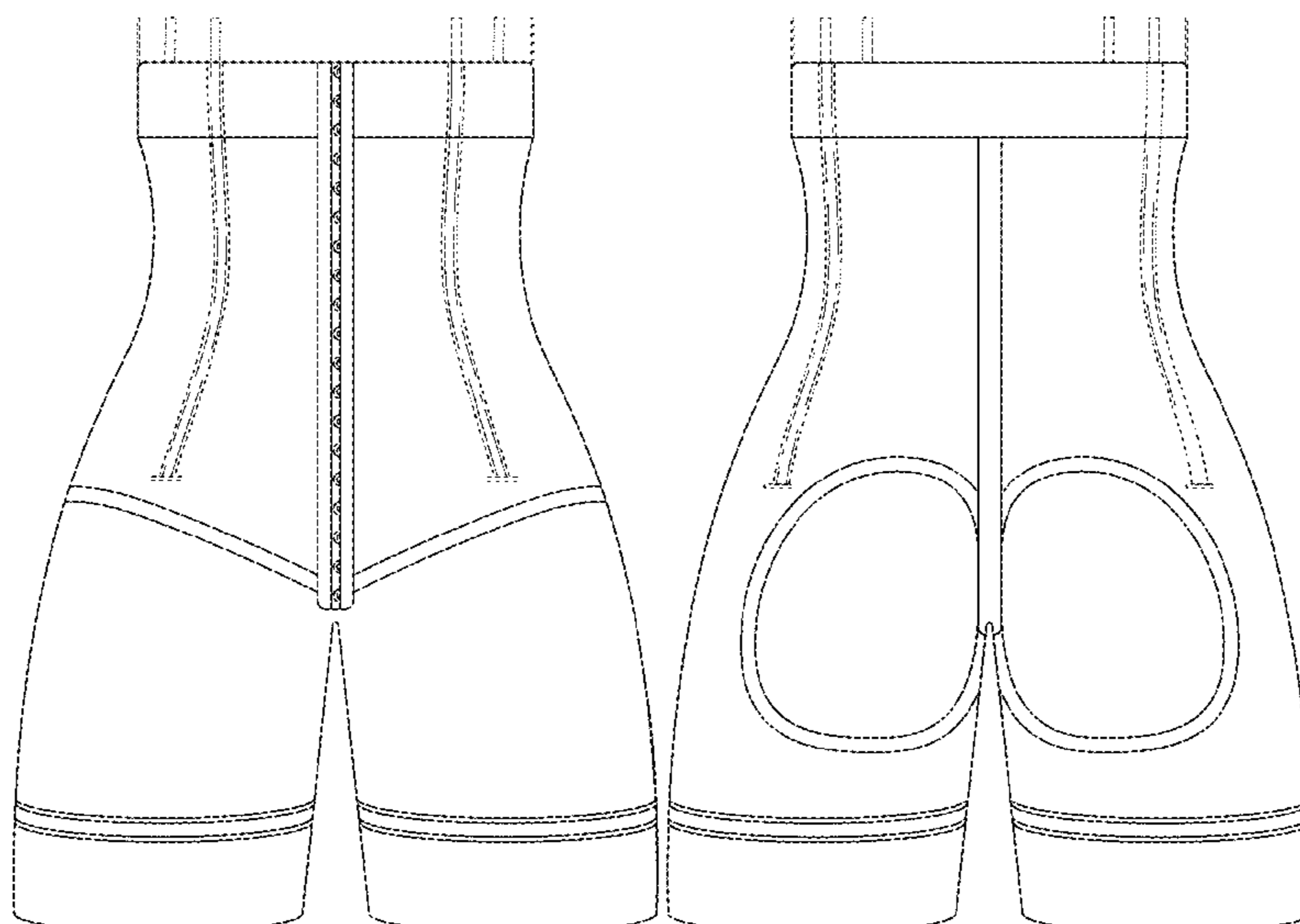

(56)

References Cited

U.S. PATENT DOCUMENTS

D548,928	S	*	8/2007	Wong	D2/731
D681,911	S	*	5/2013	Lee	D2/703
D692,208	S	*	10/2013	LaCour-Phillippi	D2/712
D797,403	S	*	9/2017	Moore	D2/731
D817,598	S	*	5/2018	Collins	D2/712
D841,937	S	*	3/2019	Yeomans	D2/731
D847,463	S	*	5/2019	Flockton	D2/731
D848,113	S	*	5/2019	Flockton	D2/731
D867,720	S	*	11/2019	Aguero	D2/700
D873,529	S	*	1/2020	Tubbs-Gingerich	D2/731
D909,009	S	*	2/2021	Huang	D2/702
D910,975	S	*	2/2021	Wang	D2/701
D928,453	S	*	8/2021	Lin	D2/702
2017/0265536	A1	*	9/2017	Flockton	A41D 27/245
2020/0253297	A1	*	8/2020	Capers	A41C 1/003
2021/0186123	A1	*	6/2021	Solano	A41C 1/06

FOREIGN PATENT DOCUMENTS

CN	306876760	*	10/2021
CO	NC2018/0004150-0	*	4/2018
KR	300823059.0000	*	11/2015
MX	56377-0001	*	10/2019

OTHER PUBLICATIONS

Ryeogo, available at amazon.com, earliest date available Nov. 23, 2020 [online], site visited Nov. 12, 2021, Available from the internet URL: <https://www.amazon.com/REYEOGO-Shapewear-Control-Panties-Underwear/dp/B08P1JMTFS/?th=1> (Year: 2020).*

Fajas M&D, available at shapewearusa.com, earliest customer review date Jul. 16, 2019 [online], site visited Nov. 12, 2021, Available from the internet URL: <https://www.shapewearusa.com/products/fajas-m-d-four-closures-strapless-short-girlidle?variant=8198929711149> (Year: 2019).*

Booty Shaper, available at shapewearfc.com, date not available [online], site visited Nov. 12, 2021, Available from the internet URL: <https://www.shapewearfc.com/collections/best-sellers-shapewear/products/fajas-colombianas-shapewear-csh>.*

* cited by examiner

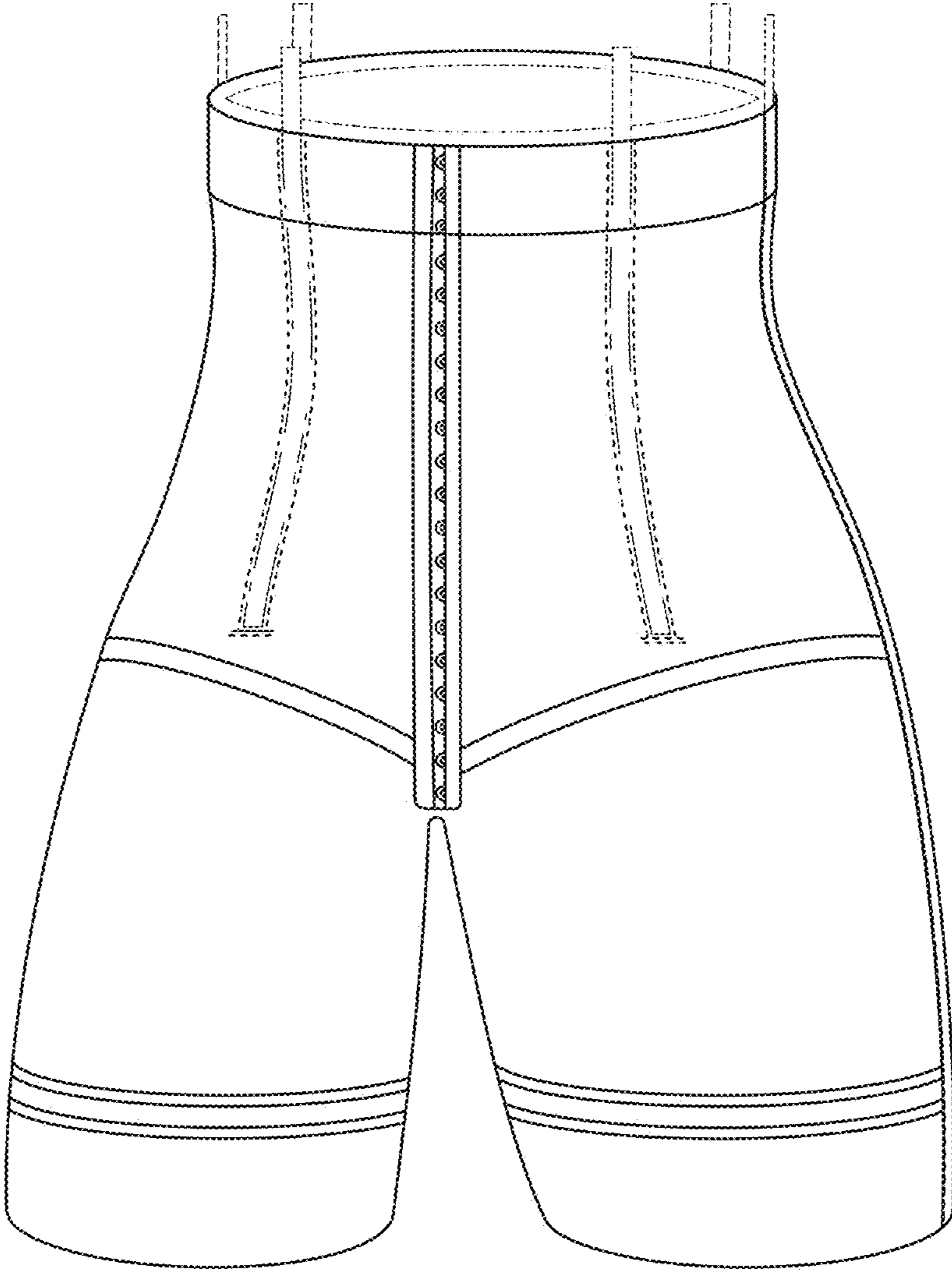

FIG. 1

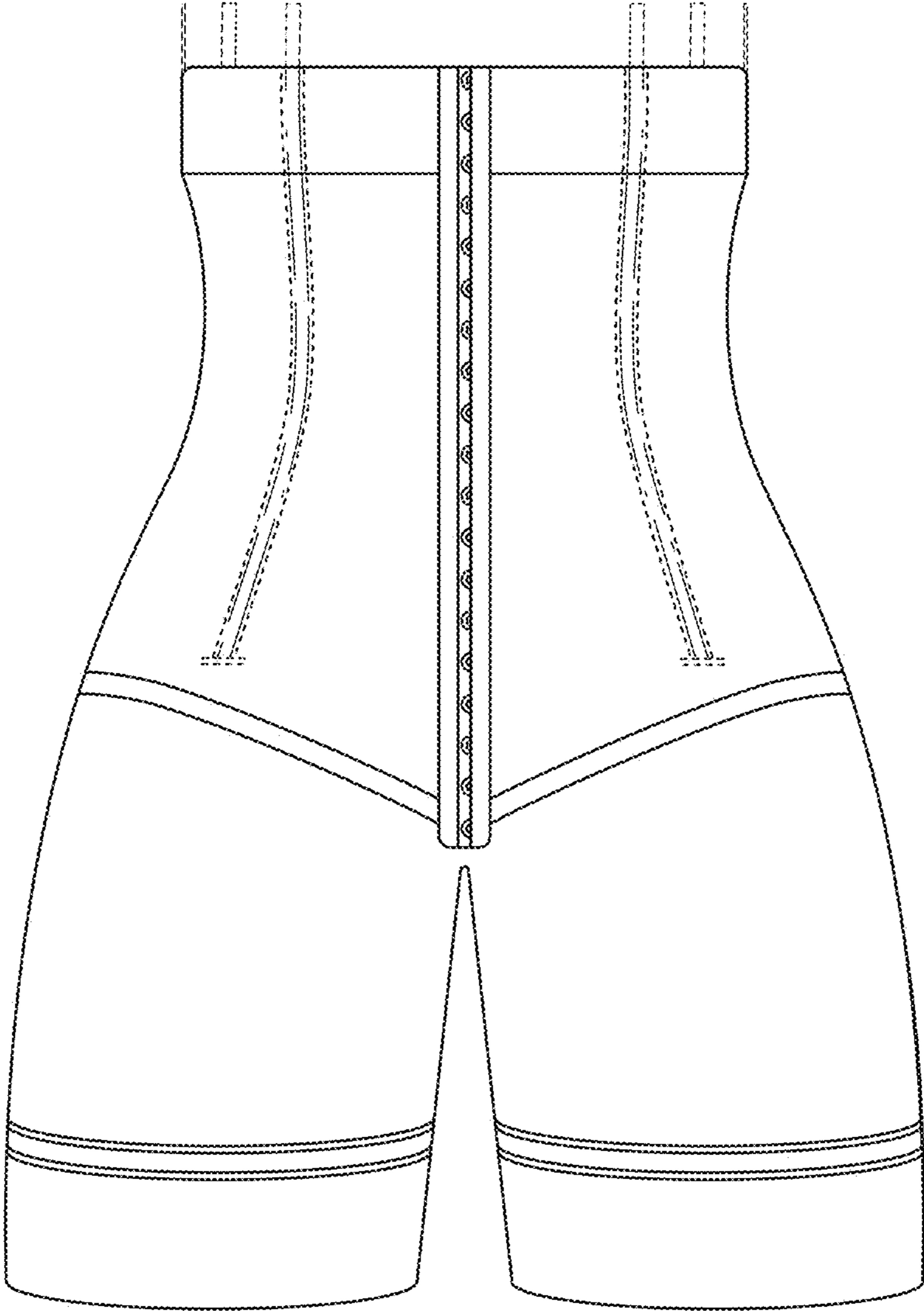

FIG. 2

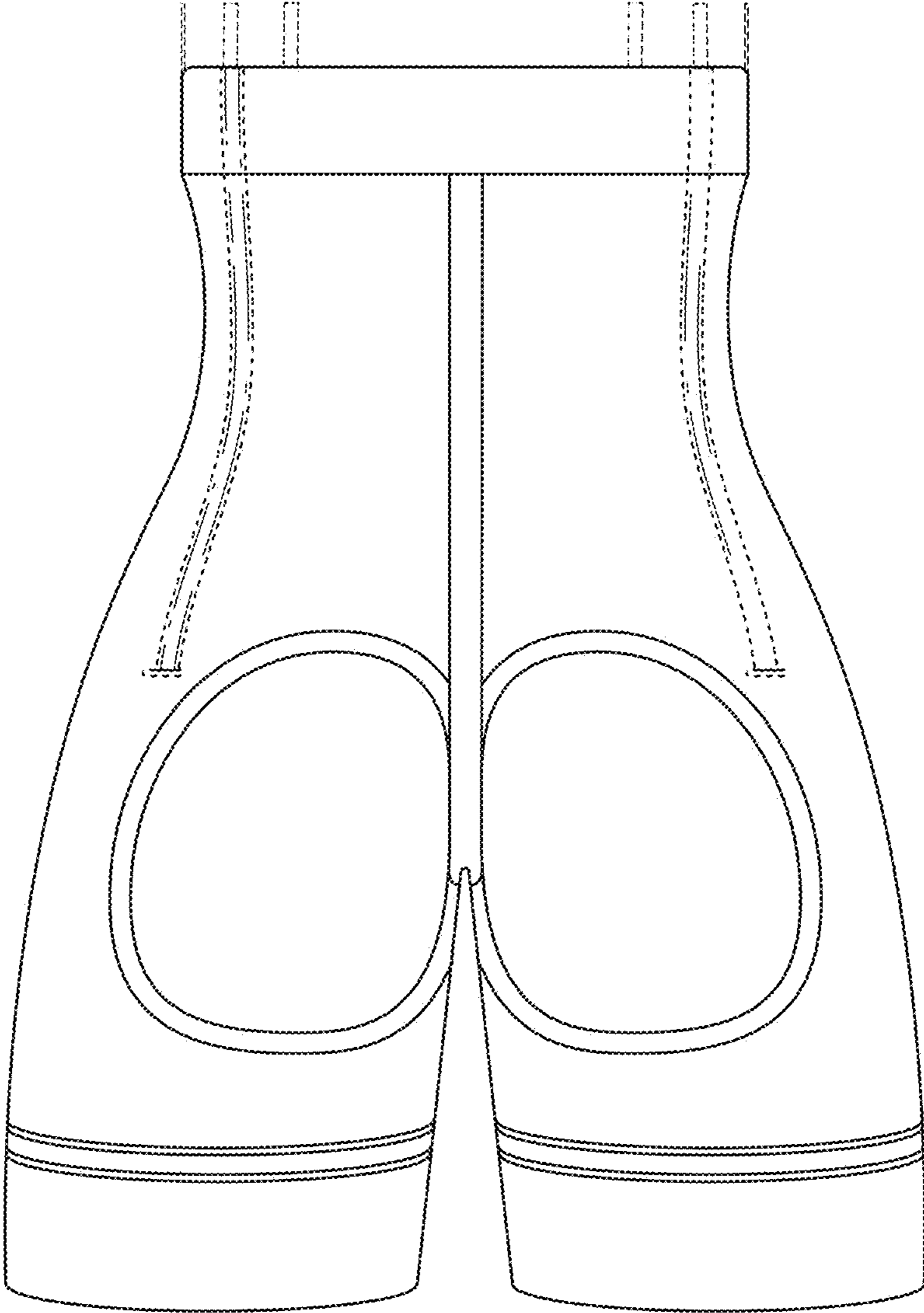

FIG. 3

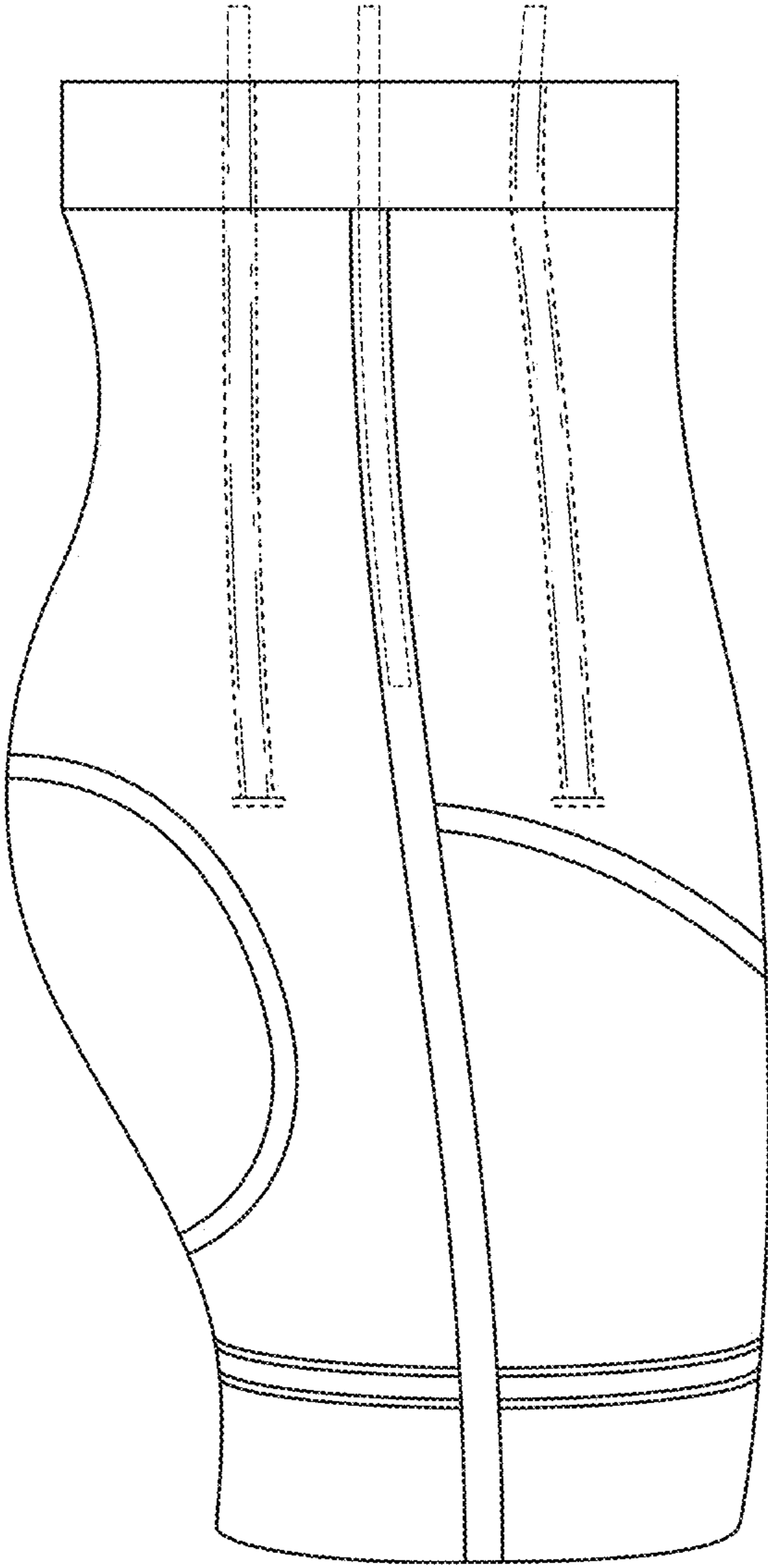

FIG. 4

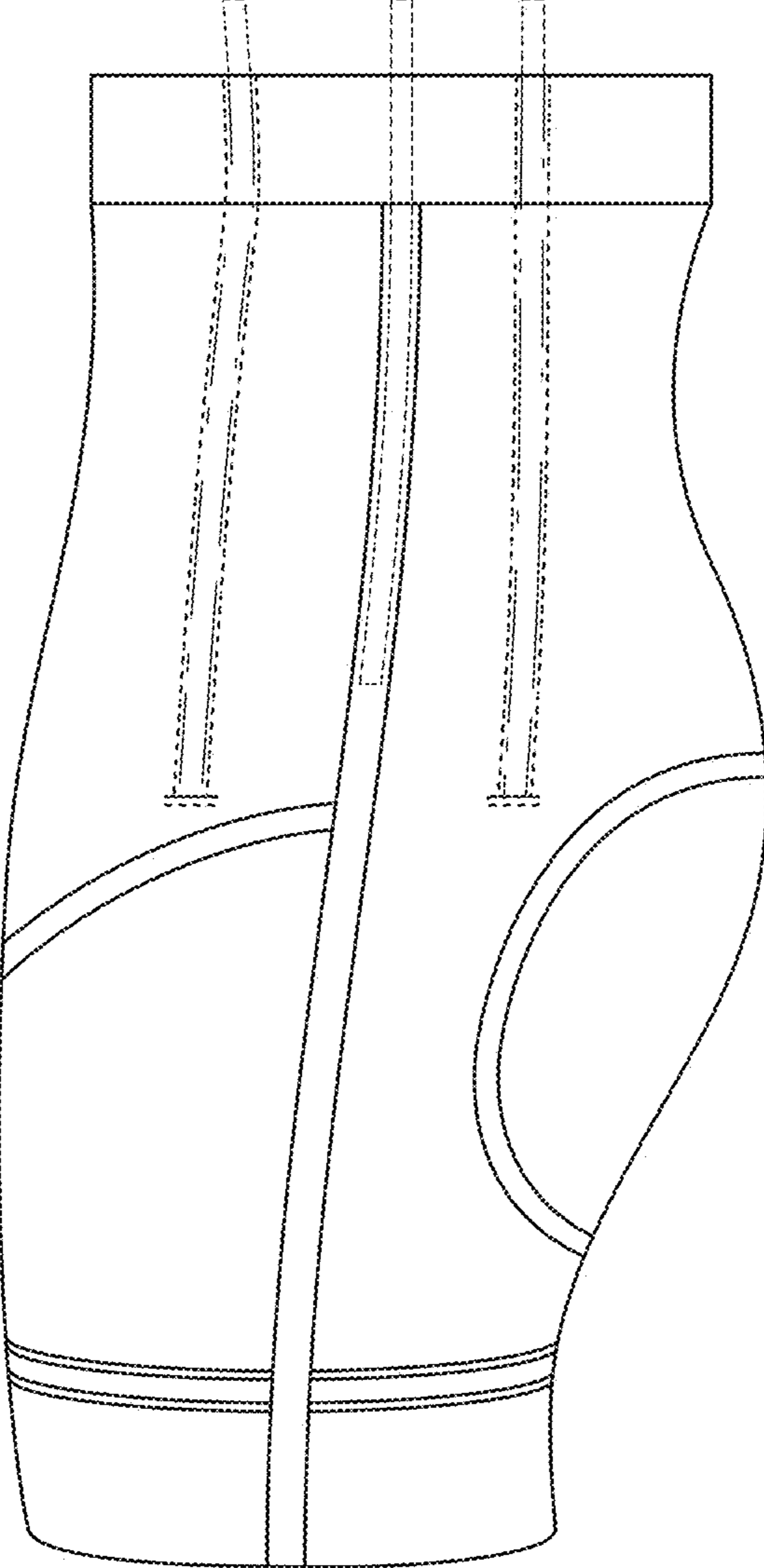

FIG. 5

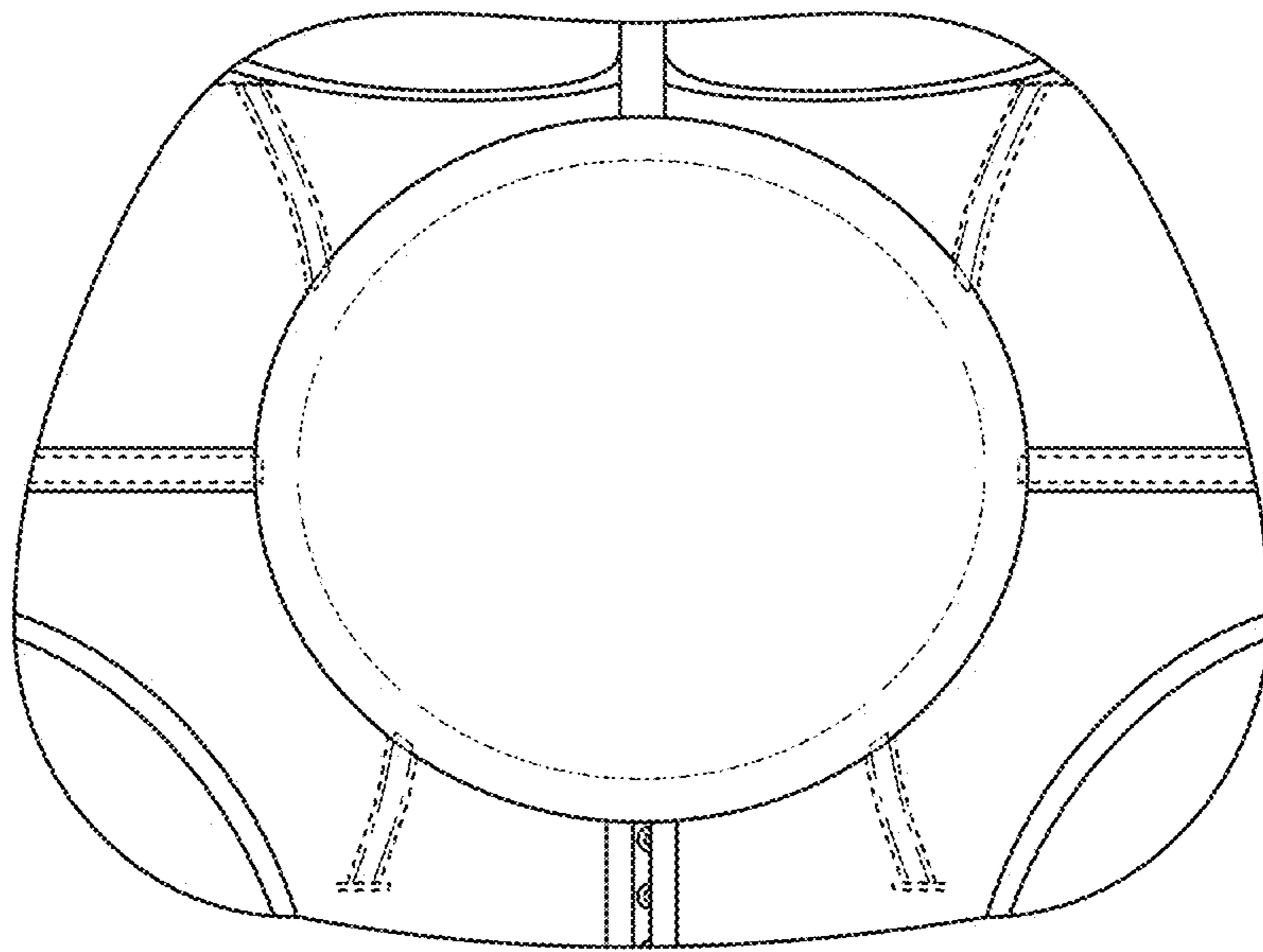

FIG. 6