



US00D977707S

(12) **United States Design Patent** (10) **Patent No.:** **US D977,707 S**  
**Filleul et al.** (45) **Date of Patent:** **\*\* \*Feb. 7, 2023**

(54) **ELECTRONIC VAPING DEVICE**

(71) Applicant: **Altria Client Services LLC**,  
Richmond, VA (US)

(72) Inventors: **Bayden Filleul**, Dublin (IE); **Michael Nolan**, Dublin (IE); **Florent Cuchet**,  
Stockholm (SE)

(73) Assignee: **Altria Client Services LLC**,  
Richmond, VA (US)

(\*) Notice: This patent is subject to a terminal disclaimer.

(\*\*) Term: **15 Years**

(21) Appl. No.: **29/816,585**

(22) Filed: **Nov. 23, 2021**

**Related U.S. Application Data**

(62) Division of application No. 29/730,913, filed on Apr. 9, 2020, now Pat. No. Des. 937,478, and a division of  
(Continued)

(30) **Foreign Application Priority Data**

Jan. 24, 2018 (EM) ..... 004678688-0001

Jan. 24, 2018 (EM) ..... 004678688-0002

(Continued)

(51) **LOC (14) Cl.** ..... **27-02**

(52) **U.S. Cl.**  
USPC ..... **D27/162**

(58) **Field of Classification Search**

USPC ..... D27/162, 100, 101, 163-165, 172, 183,  
D27/185-194; D24/110, 110.5; D23/366  
(Continued)

(56) **References Cited**

**U.S. PATENT DOCUMENTS**

D644,375 S 8/2011 Zhou  
D658,807 S 5/2012 Aboushi  
(Continued)

**OTHER PUBLICATIONS**

Office Action dated May 27, 2022 issued in corresponding U.S. Appl. No. 29/825,007.

(Continued)

*Primary Examiner* — Rebecca Tsehaye

(74) *Attorney, Agent, or Firm* — Harness, Dickey & Pierce, P.L.C.

(57) **CLAIM**

The ornamental design for an electronic vaping device, as shown and described.

**DESCRIPTION**

FIG. 1 is a front-top perspective view of an electronic vaping device;

FIG. 2 is a front view of the electronic vaping device shown in FIG. 1;

FIG. 3 is a rear view of the electronic vaping device shown in FIG. 1;

FIG. 4 is a left side view of the electronic vaping device shown in FIG. 1;

FIG. 5 is a right side view of the electronic vaping device shown in FIG. 1;

FIG. 6 is a top view of the electronic vaping device shown in FIG. 1;

FIG. 7 is a bottom view of the electronic vaping device shown in FIG. 1; and,

(Continued)

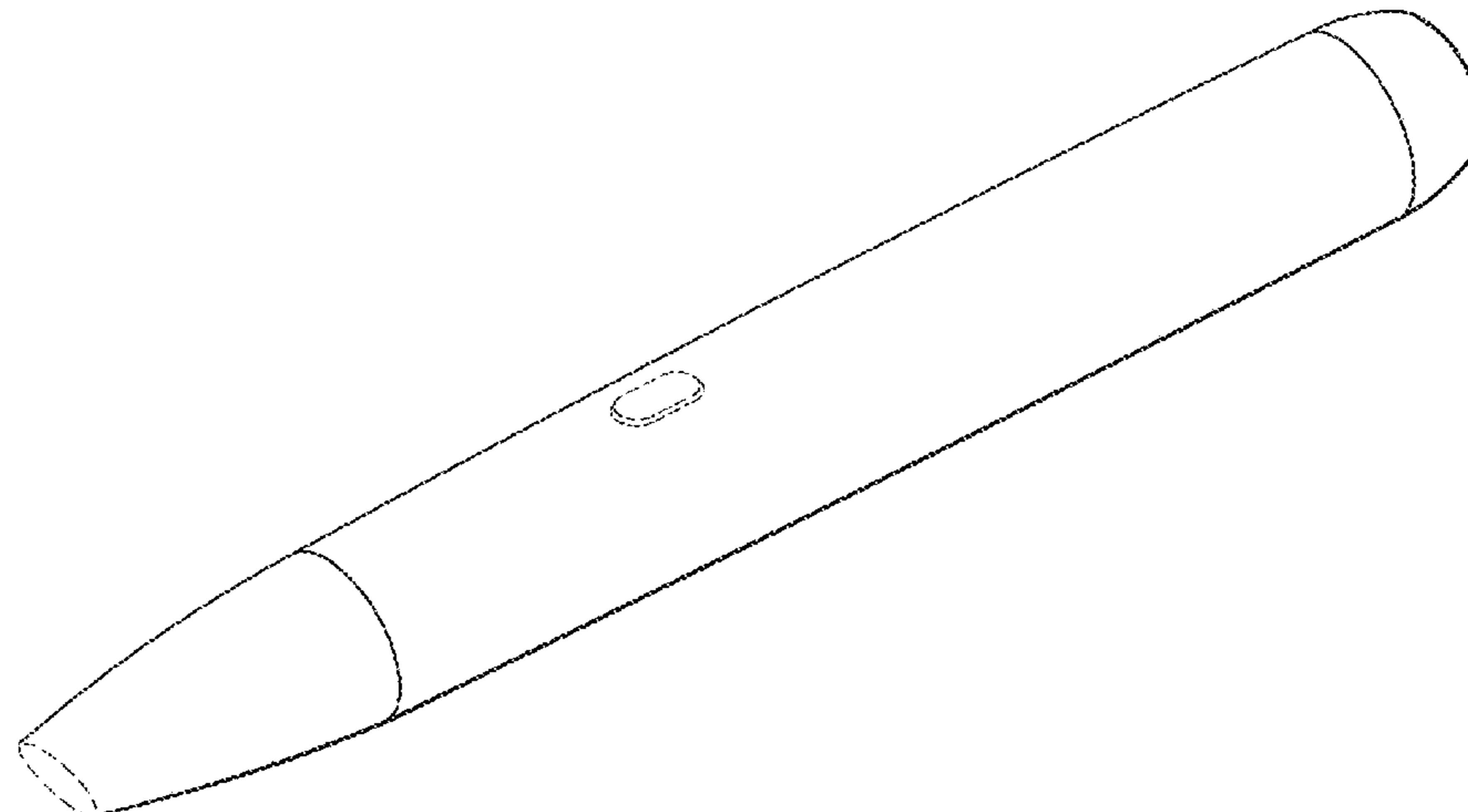

FIG. 8 is a rear-bottom perspective view of the electronic vaping device shown in FIG. 1.

The dashed lines in the drawings depict portions of the electronic vaping device that form no part of the ornamental design.

**1 Claim, 8 Drawing Sheets**

**Related U.S. Application Data**

application No. 29/657,303, filed on Jul. 20, 2018, now Pat. No. Des. 883,566.

**(30) Foreign Application Priority Data**

Jan. 24, 2018	(EM)	004678688-0003
Jan. 24, 2018	(EM)	004678688-0004
Jan. 24, 2018	(EM)	004678688-0005
Jan. 24, 2018	(EM)	004678688-0006
Jan. 24, 2018	(EM)	004678688-0007
Jan. 24, 2018	(EM)	004678688-0008
Jan. 24, 2018	(EM)	004678688-0009
Jan. 24, 2018	(EM)	004678688-0010
Jan. 24, 2018	(EM)	004678688-0011
Jan. 24, 2018	(EM)	004678688-0012

**(58) Field of Classification Search**

CPC .... A24F 47/002; A24F 47/006; A24F 47/008; A61M 15/00; A61M 15/06  
See application file for complete search history.

**(56) References Cited**

**U.S. PATENT DOCUMENTS**

D693,053 S	11/2013	Chen
D695,450 S	12/2013	Benassayag et al.
D720,094 S	12/2014	Alima
D720,095 S	12/2014	Alima
D720,496 S	12/2014	Alima
D720,881 S	1/2015	Liu
D720,882 S	1/2015	Albanese
D723,216 S	2/2015	Chen
D761,998 S	7/2016	Pinder
D779,722 S	2/2017	Volodarsky
D782,728 S	3/2017	Pinder
D790,122 S	6/2017	Hawes et al.
D799,745 S *	10/2017	Qiu ..... D27/101
D800,383 S	10/2017	Verleur et al.
D802,839 S	11/2017	Scott
D805,246 S	12/2017	Fakhouri
D805,684 S	12/2017	Thuery
D809,190 S	1/2018	Schuler et al.
D813,445 S	3/2018	Scott
D813,447 S	3/2018	Watson
D814,694 S	4/2018	Watson
D818,636 S	5/2018	Qiu
D818,638 S	5/2018	Wright et al.
D822,271 S	7/2018	Eksouzian
D825,099 S *	8/2018	Wright ..... D27/101
D825,103 S	8/2018	Wright et al.
D825,844 S	8/2018	Verleur et al.

D829,369 S	9/2018	Stone
D829,370 S	9/2018	Stone
D829,974 S	10/2018	Stone
D829,976 S	10/2018	Stone
D829,977 S	10/2018	Stone
D829,978 S	10/2018	Stone
D847,419 S	4/2019	Hawes et al.
D855,881 S	8/2019	Hawes et al.
D862,793 S	10/2019	Chang et al.
D866,061 S *	11/2019	Lalehzadeh ..... D27/162
D866,064 S	11/2019	Powell et al.
D868,360 S	11/2019	Stone
D868,363 S	11/2019	Stone
D868,364 S	11/2019	Stone
D869,747 S	12/2019	Stone
D871,662 S	12/2019	Volodarsky et al.
D871,665 S	12/2019	Choe
D876,719 S	2/2020	Vermette et al.
D877,409 S	3/2020	Jiang
D878,671 S	3/2020	Stone
D882,165 S	4/2020	Ouyang
D883,566 S	5/2020	Filleul et al.
D889,034 S	6/2020	Stewart et al.
D894,478 S	8/2020	Fornarelli
D901,068 S	11/2020	Stone
D901,069 S	11/2020	Stone
D901,757 S	11/2020	Stone
D901,758 S	11/2020	Stone
D905,331 S	12/2020	Stone
D907,285 S	1/2021	Stone
D907,843 S	1/2021	Stone
D913,580 S	3/2021	Barenboym
D920,570 S	5/2021	Laidlaw et al.
D921,969 S	6/2021	Simrell
D937,478 S *	11/2021	Filleul ..... D27/162
D940,386 S	1/2022	Campitelli
D943,143 S	2/2022	Zuber et al.
D943,806 S	2/2022	Filleul et al.
D945,058 S *	3/2022	Rosen ..... D27/162
D946,205 S	3/2022	Rochon
D948,111 S *	4/2022	Benhalima ..... D27/162
D953,614 S *	5/2022	Fornarelli ..... D27/162
2019/0166919 A1 *	6/2019	Yilmaz ..... A24F 40/485
2019/0201639 A1 *	7/2019	Lutz ..... A61M 11/02

**OTHER PUBLICATIONS**

U.S. Office Action dated Nov. 13, 2020, issued in corresponding U.S. Appl. No. 29/657,302.  
U.S. Office Action dated Apr. 1, 2021, issued in corresponding U.S. Appl. No. 29/657,300.  
U.S. Office Action dated Jun. 4, 2021, issued in corresponding U.S. Appl. No. 29/657,302.  
U.S. Office Action dated Jul. 9, 2021, issued in co-pending U.S. Appl. No. 29/657,300.  
U.S. Notice of Allowance dated Jul. 21, 2021, issued in co-pending U.S. Appl. No. 29/730,913.  
U.S. Notice of Allowance dated Oct. 14, 2021, issued in co-pending U.S. Appl. No. 29/657,302.  
Office Action dated Mar. 1, 2022 issued in corresponding U.S. Appl. No. 29/657,300.  
Notice of Allowance dated Jun. 23, 2022 issued in corresponding U.S. Appl. No. 29/657,300.  
Notice of Allowance dated Nov. 23, 2022, issued in corresponding U.S. Appl. No. 29/825,007.

\* cited by examiner

FIG. 1

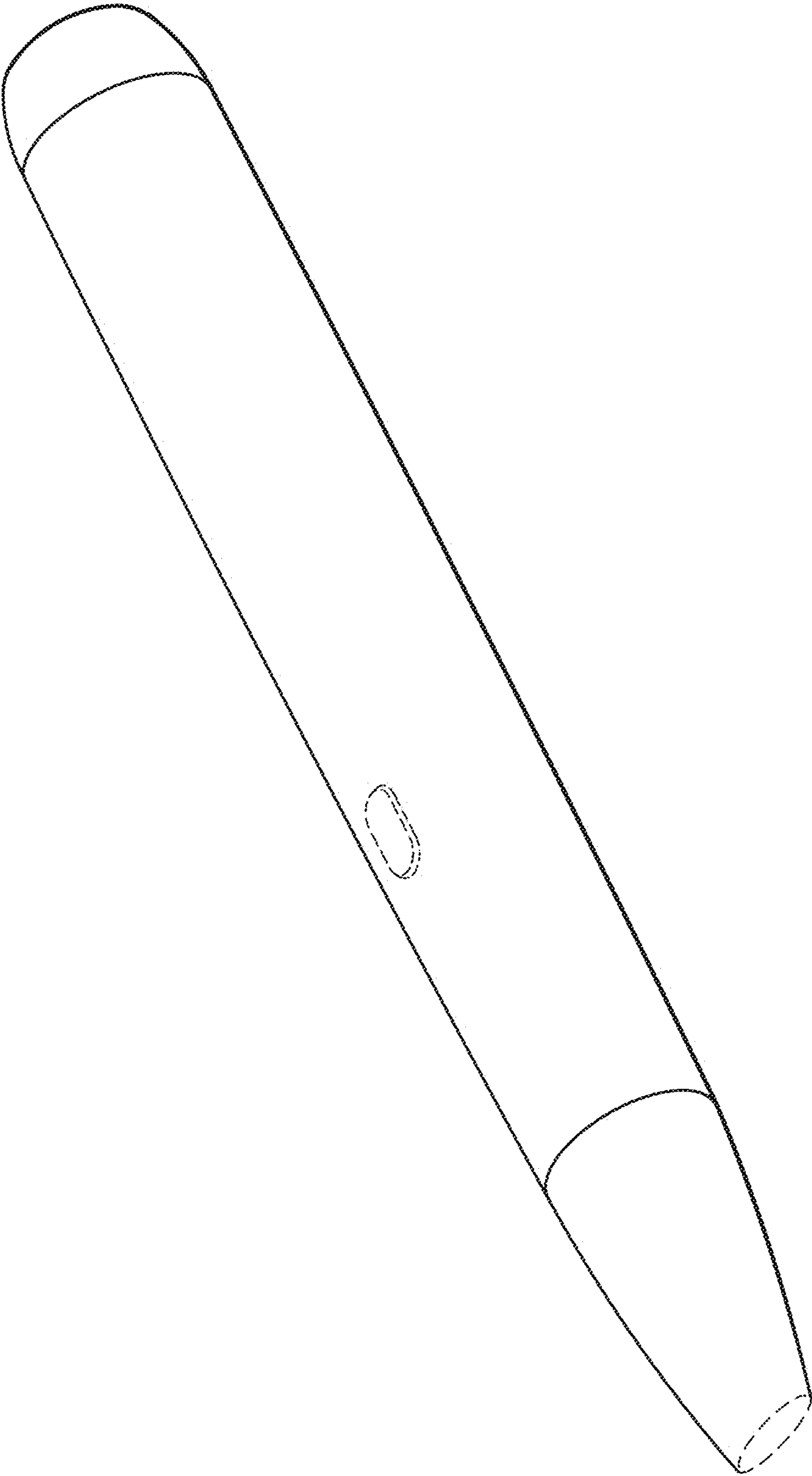

FIG. 2

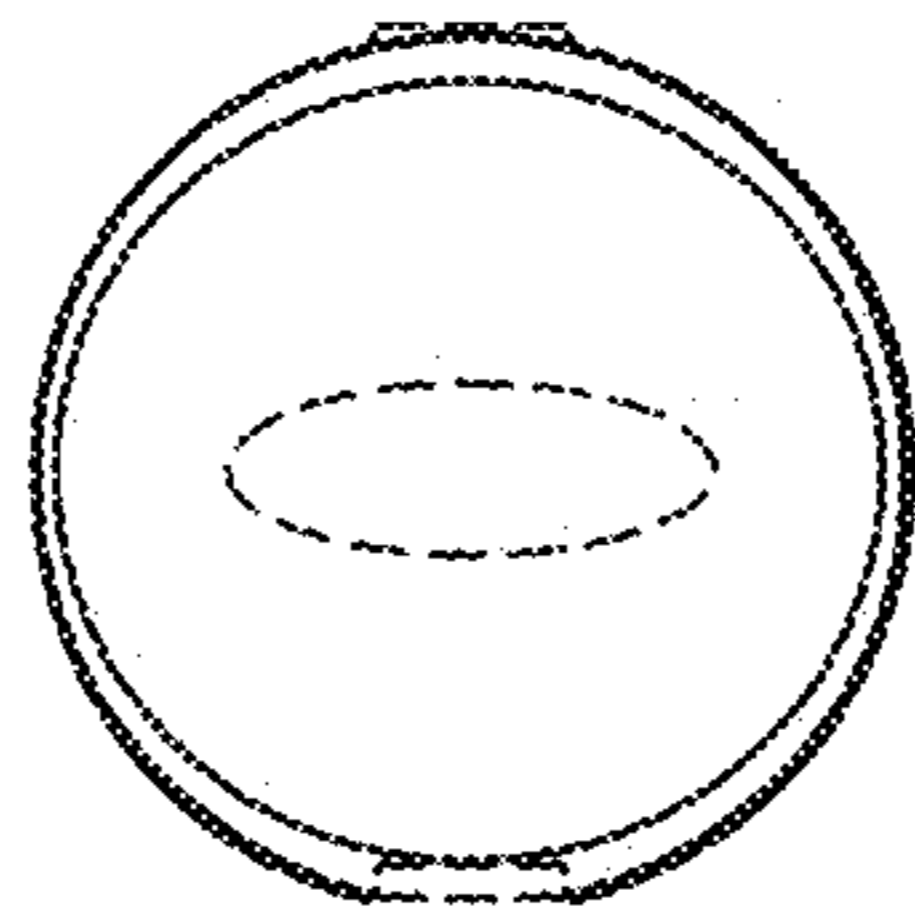

FIG. 3

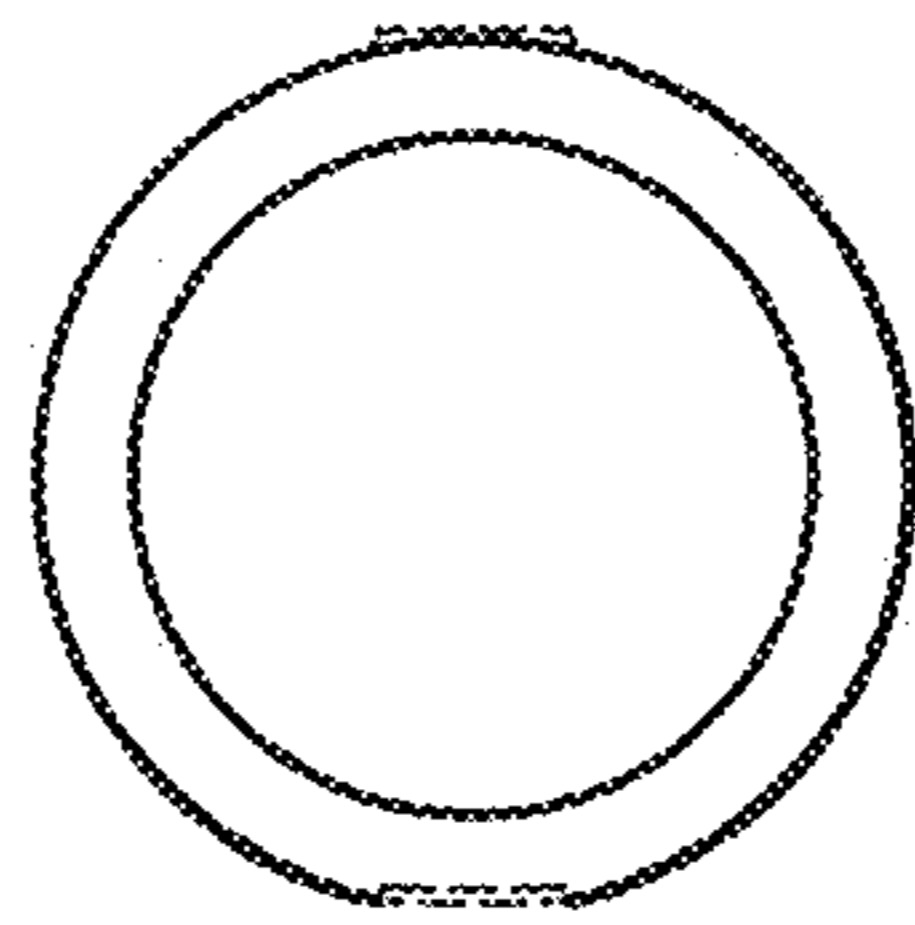

FIG. 4

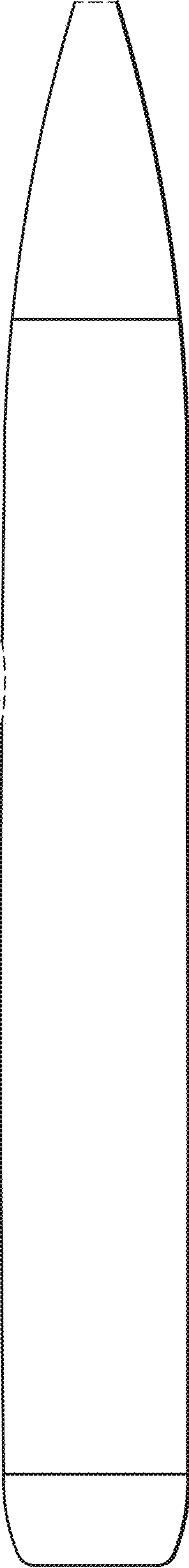

FIG. 5

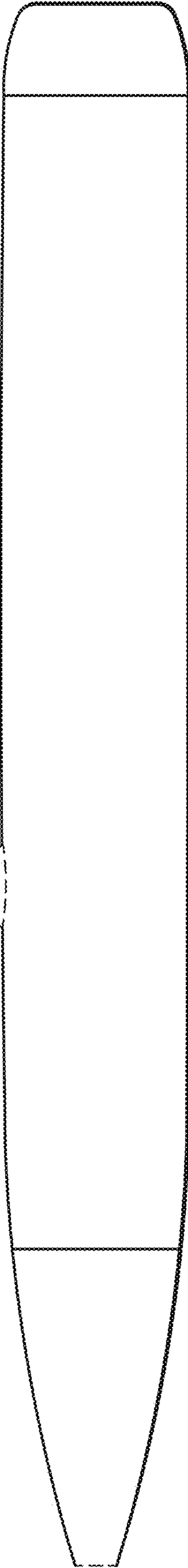

FIG. 6

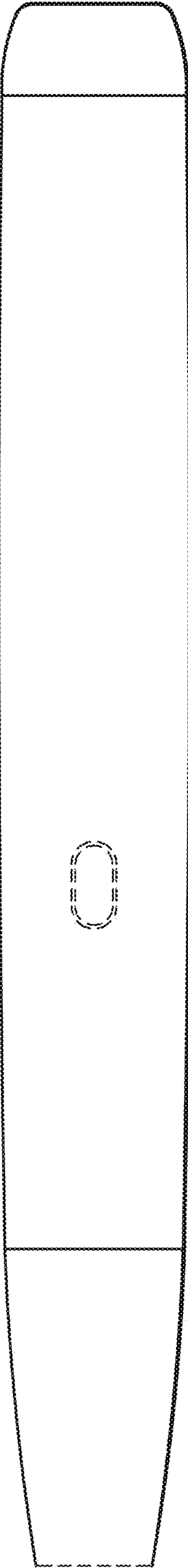



FIG. 7

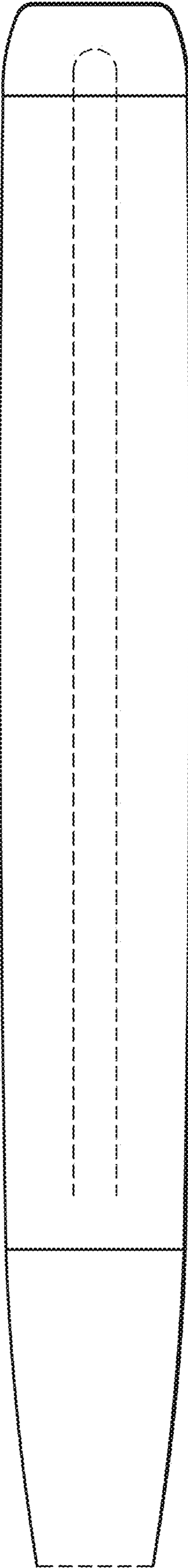

FIG. 8

