

US00D977666S

(12) **United States Design Patent**  
**Zheng**

(10) **Patent No.:** **US D977,666 S**  
(45) **Date of Patent:** **\*\* Feb. 7, 2023**

(54) **VIBRATOR**

FOREIGN PATENT DOCUMENTS

(71) Applicant: **Xinglong Zheng**, Jiangxi (CN)

CN 305309106 \* 8/2019  
CN 306859040 \* 9/2021

(72) Inventor: **Xinglong Zheng**, Jiangxi (CN)

(\*\*) Term: **15 Years**

OTHER PUBLICATIONS

(21) Appl. No.: **29/850,124**

Visetoyz—Tongue Licking Mini Clitoral Vibrator. Date: Feb. 14, 2022. [online]. [Site visited Nov. 28, 2022]. Available from Internet URL: <https://www.amazon.com/dp/B09N8R89TD/> (Year: 2022).\*

(22) Filed: **Aug. 17, 2022**

(Continued)

(30) **Foreign Application Priority Data**

*Primary Examiner* — Susan Bennett Hattan  
*Assistant Examiner* — Landon Thomas Cassell

Apr. 8, 2022 (CN) ..... 202230196367.0

(51) **LOC (14) Cl.** ..... **28-03**

(57) **CLAIM**

The ornamental design for a vibrator, as shown and described.

(52) **U.S. Cl.**

USPC ..... **D24/215**

**DESCRIPTION**

(58) **Field of Classification Search**

USPC ..... D24/215, 200, 211, 212, 213, 214, 133,  
D24/107, 231, 184, 209, 206, 104, 108,  
D24/121, 141; D30/160; D23/366  
CPC ..... A61H 19/00; A61H 19/30; A61H 19/32;  
A61H 19/34; A61H 19/40; A61H 19/44;  
A61H 19/50; A61H 21/00; A61H  
2205/087

See application file for complete search history.

FIG. 1 is a front and top perspective view of a first embodiment of a vibrator, showing my new design; FIG. 2 is a rear and bottom perspective view thereof; FIG. 3 is a front view thereof; FIG. 4 is a rear view thereof; FIG. 5 is a left side view thereof; FIG. 6 is a right side view thereof; FIG. 7 is a top view thereof; FIG. 8 is a bottom view thereof; FIG. 9 is a front and top perspective view of a second embodiment of the vibrator; FIG. 10 is a rear and bottom, perspective view thereof; FIG. 11 is a front view thereof; FIG. 12 is a rear view thereof; FIG. 13 is a left side view thereof; FIG. 14 is a right side view thereof; FIG. 15 is a top view thereof; and, FIG. 16 is a bottom view thereof. The dashed lines in the figures illustrate portions of the vibrator that form no part of the claimed design.

(56) **References Cited**

U.S. PATENT DOCUMENTS

D380,821 S \* 7/1997 Chen ..... D9/663  
D715,910 S \* 10/2014 Lin ..... A61L 9/03  
D23/366  
D911,544 S \* 2/2021 Zhou ..... D24/215  
11,007,110 B1 \* 5/2021 Zhou ..... A61H 23/0263  
D925,056 S \* 7/2021 Li ..... D24/215  
D930,180 S \* 9/2021 Wang ..... D24/215  
D933,252 S 10/2021 Cheung  
D939,726 S \* 12/2021 Liu ..... D24/215  
11,369,545 B1 \* 6/2022 He ..... A61H 23/0263

(Continued)

**1 Claim, 16 Drawing Sheets**

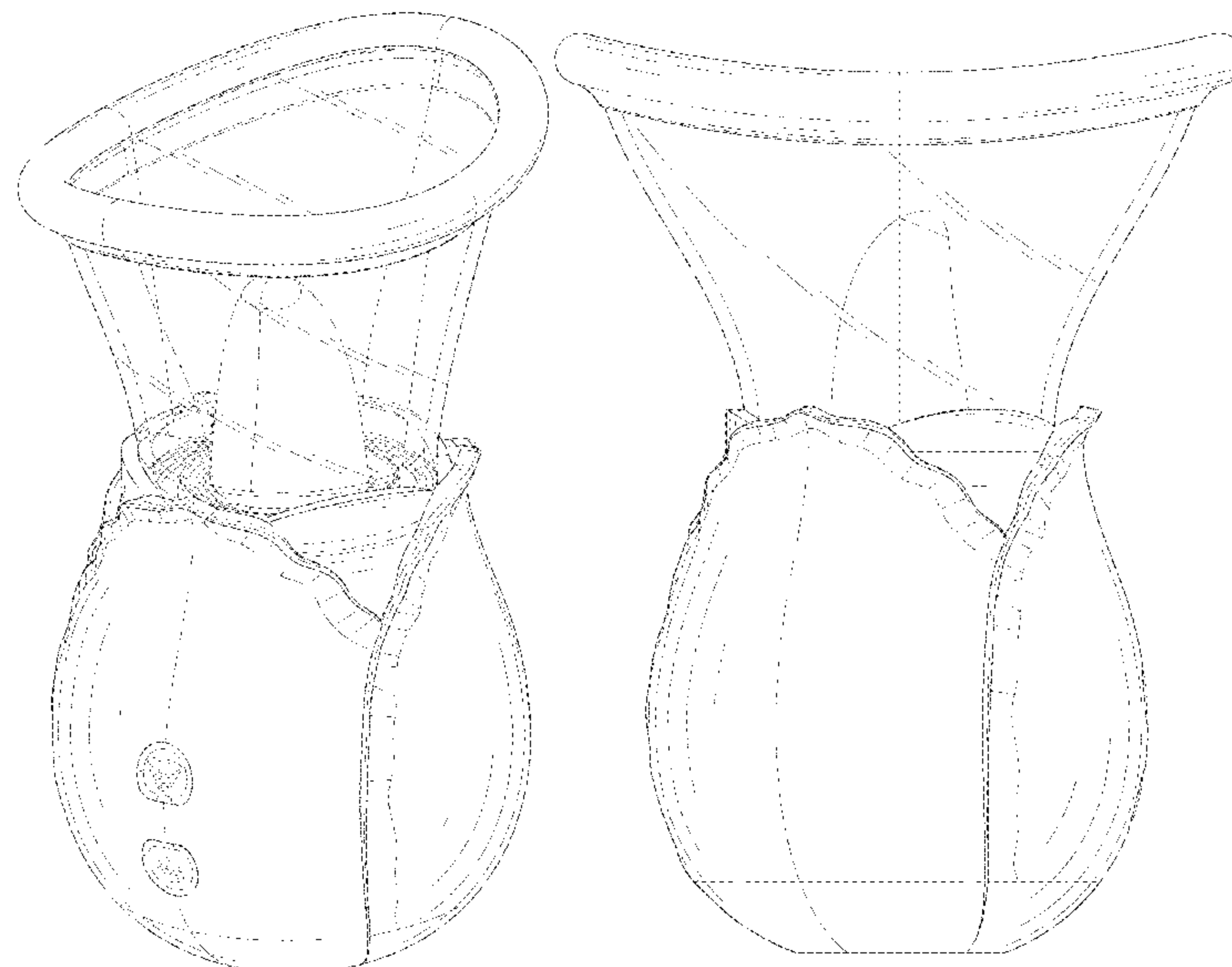

(56)

**References Cited**

U.S. PATENT DOCUMENTS

D959,691 S \* 8/2022 Liang ..... D24/215  
D961,110 S \* 8/2022 Zhang ..... D24/215  
D968,634 S \* 11/2022 Zhou ..... D24/215  
2022/0296459 A1 \* 9/2022 Jin ..... A61H 1/00

OTHER PUBLICATIONS

Kushor—Licking Vibrator. Date: Apr. 21, 2022. [online]. [Site visited Nov. 28, 2022]. Available from Internet URL: <https://www.amazon.com/dp/B09XV2WP27/> (Year: 2022).\*

Vibrators. (Design—© Questel) orbit.com. [Online PDF compilation of references] 40 pgs. Print Dates Range May 17, 2019-Mar. 29, 2022 [Retrieved Nov. 28, 2022] <https://www.orbit.com/export/UCZAH96B/pdf4/bfaf8a3d-6acf-4209-bb7d-3befa7a52a09-212744.pdf> (Year: 2022).\*

\* cited by examiner

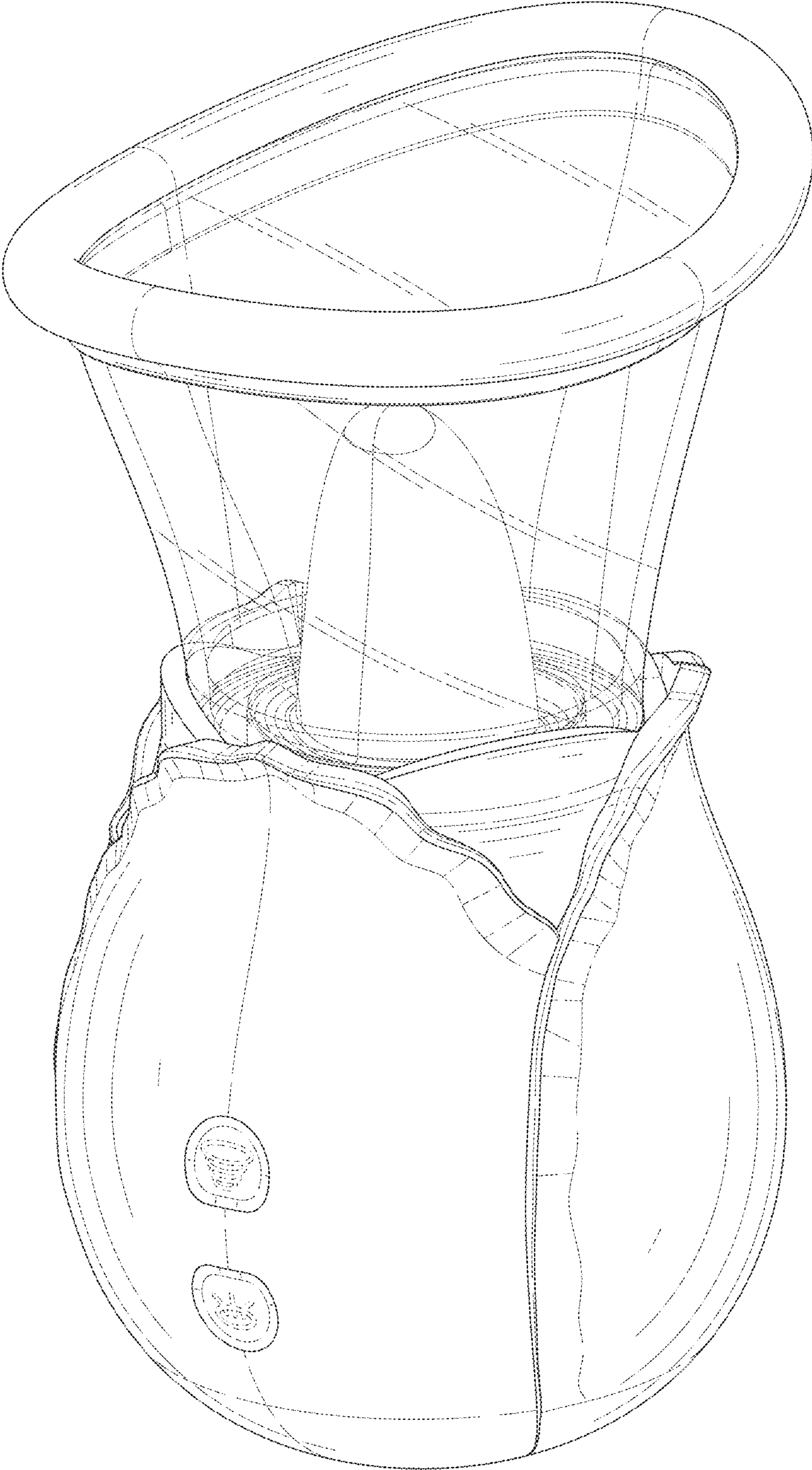

FIG. 1

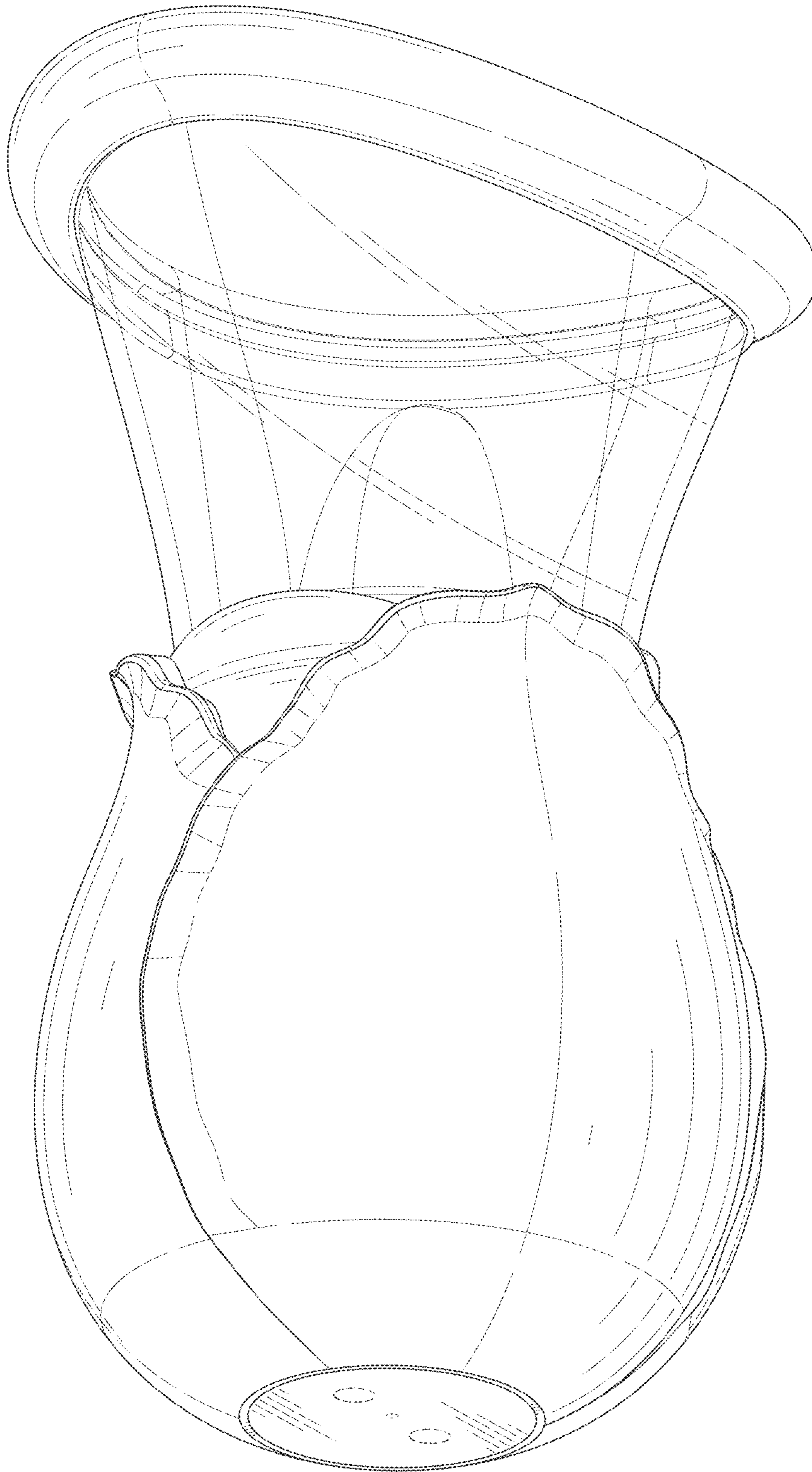

FIG. 2



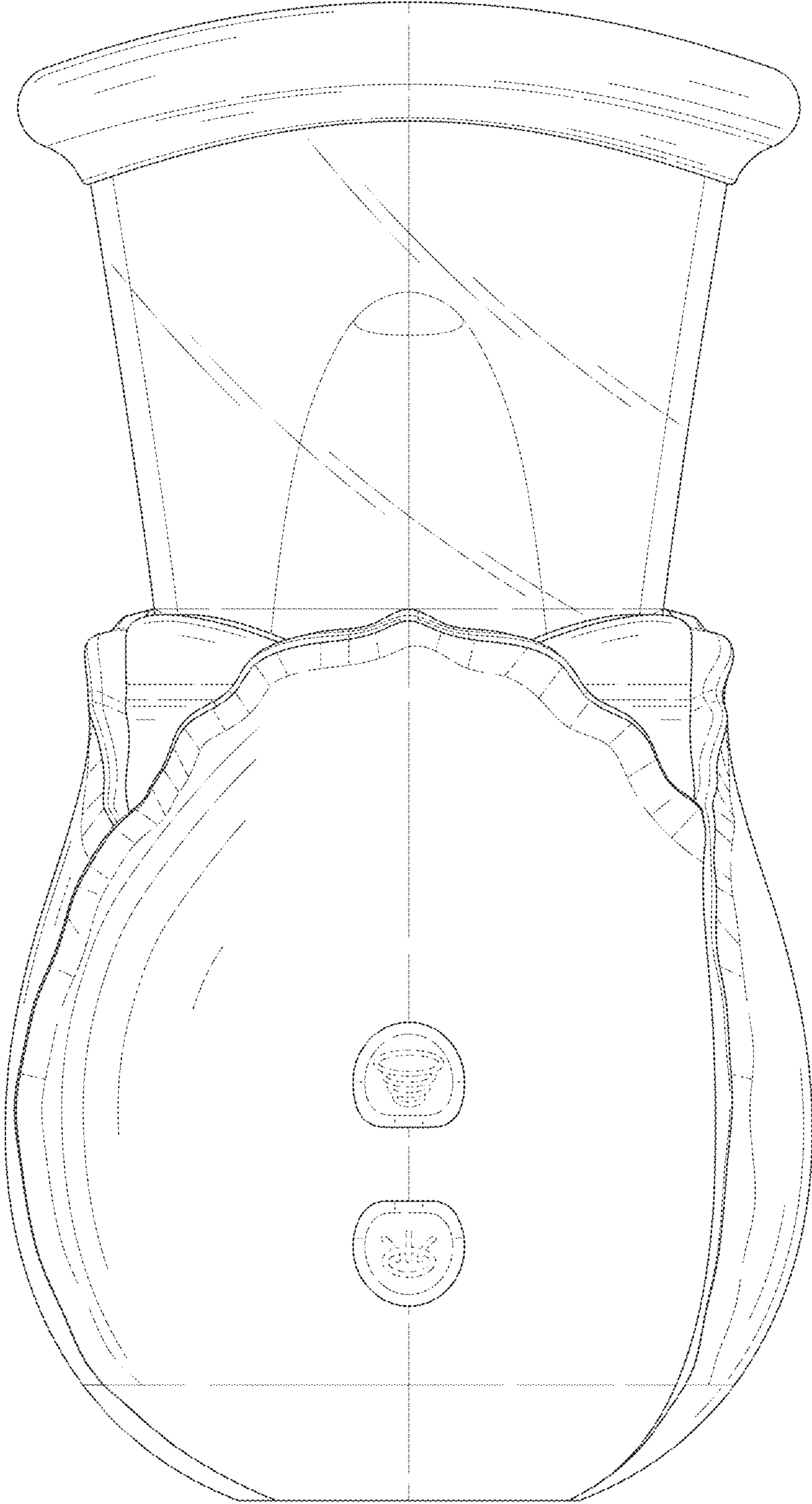

FIG. 3

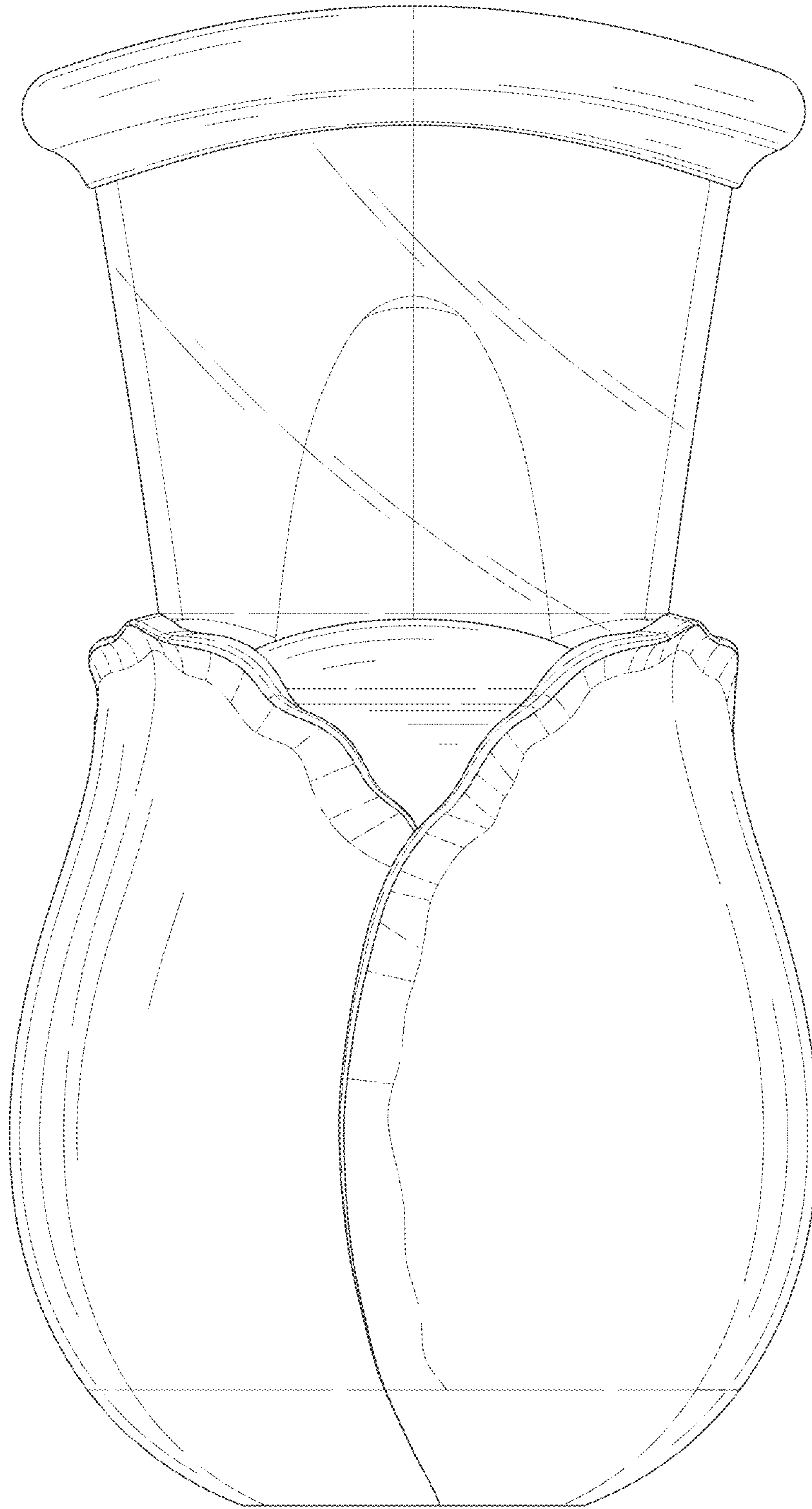

FIG. 4

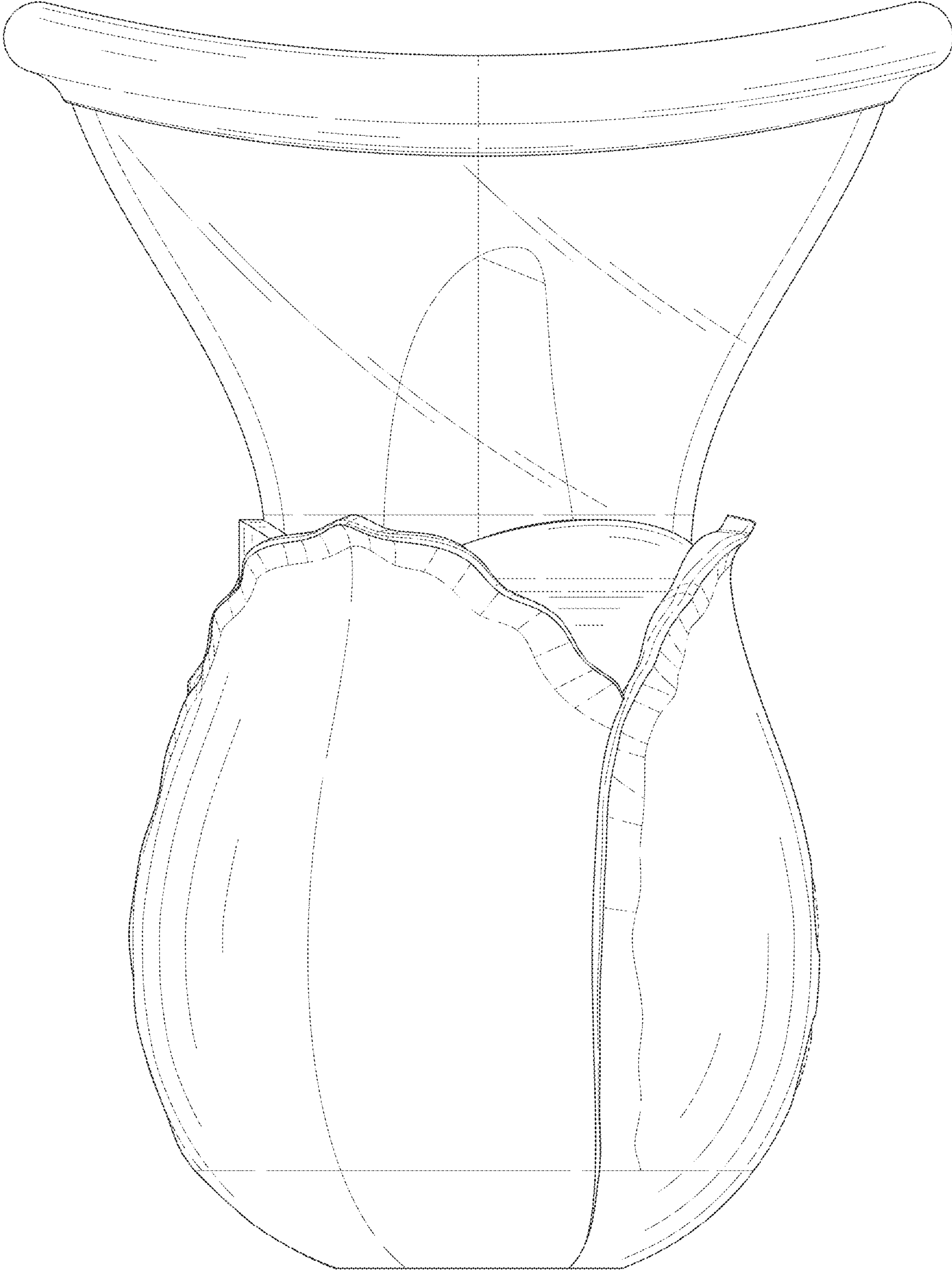

FIG. 5

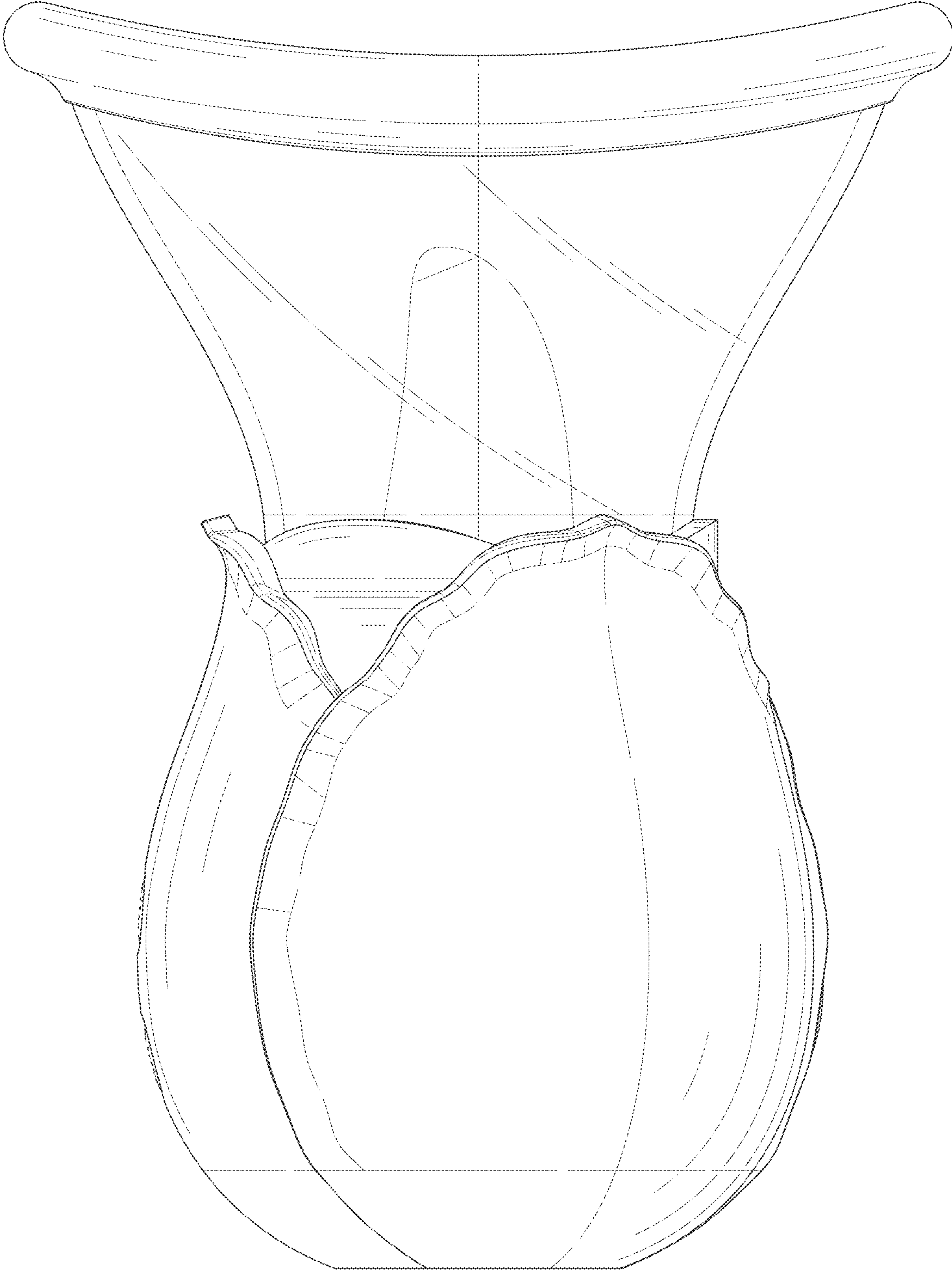

FIG. 6



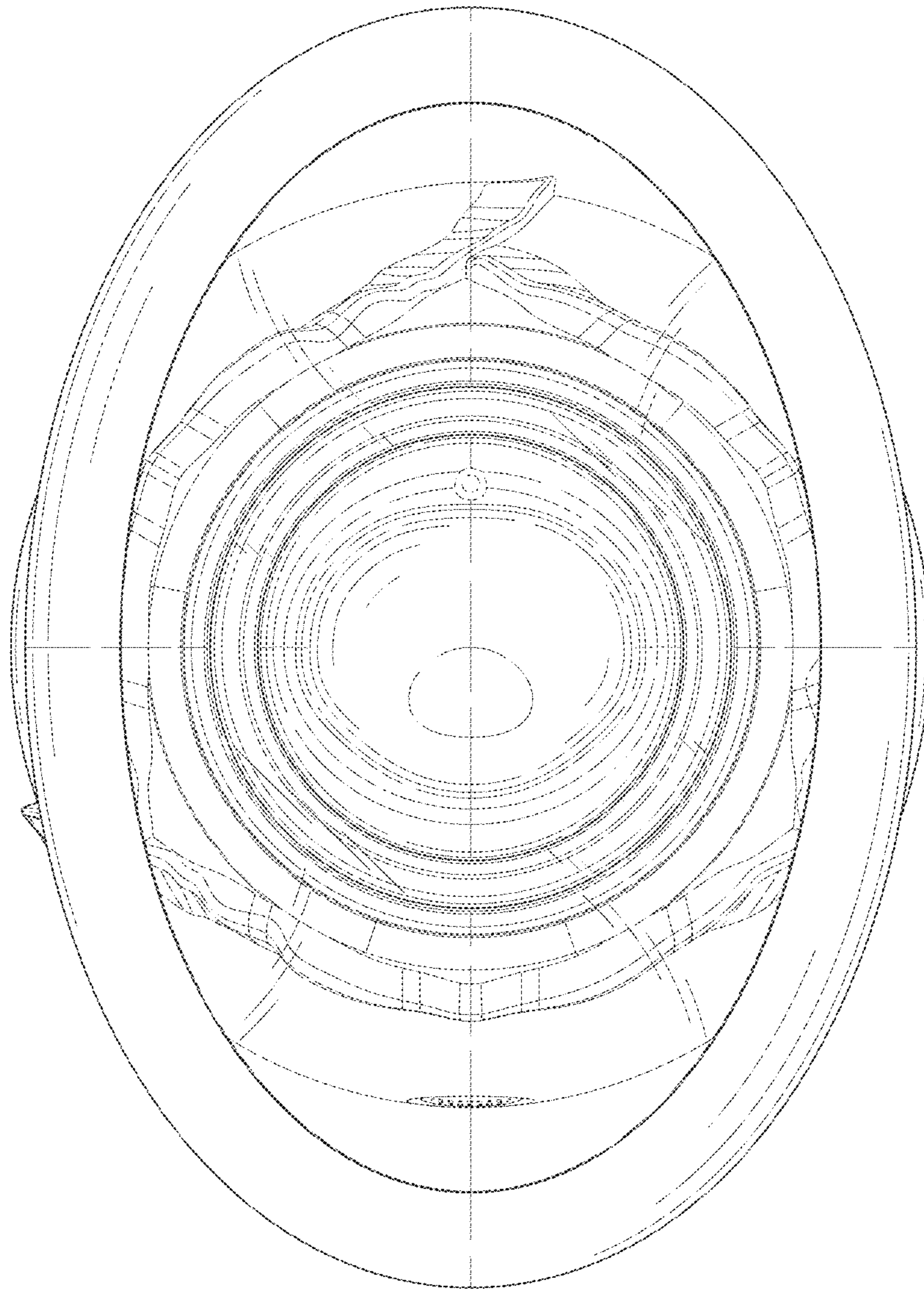

FIG. 7

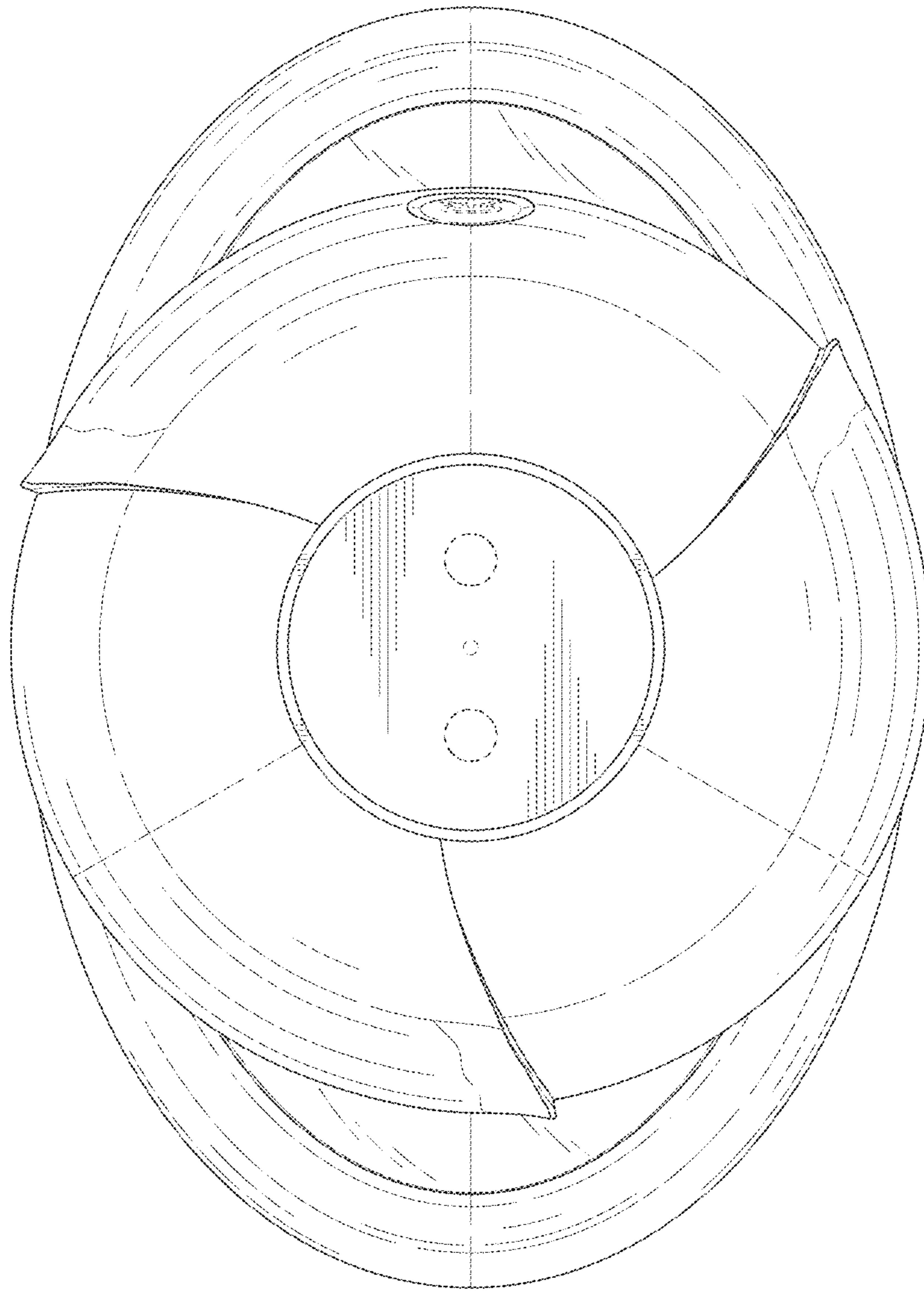

FIG. 8

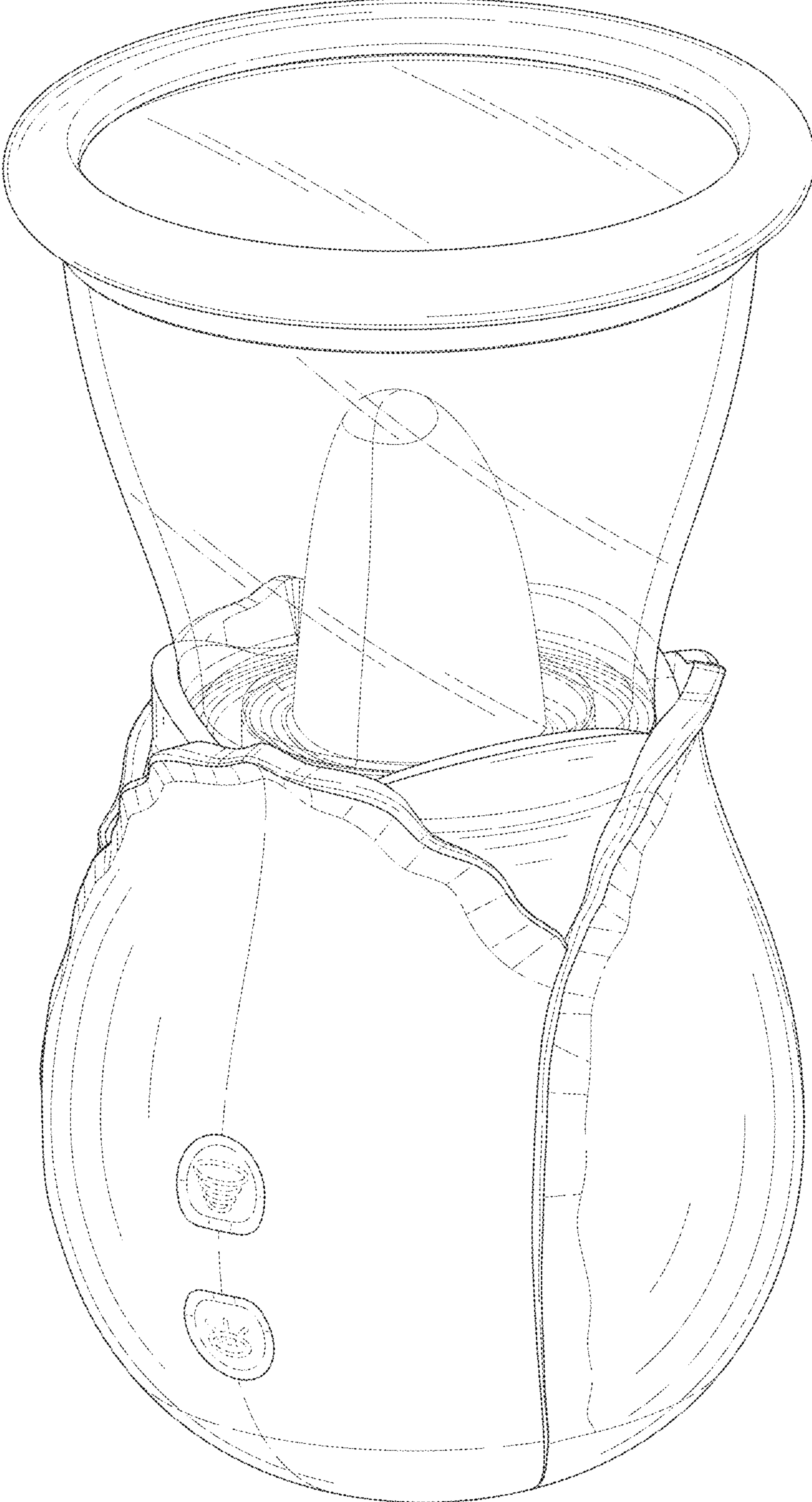

FIG. 9

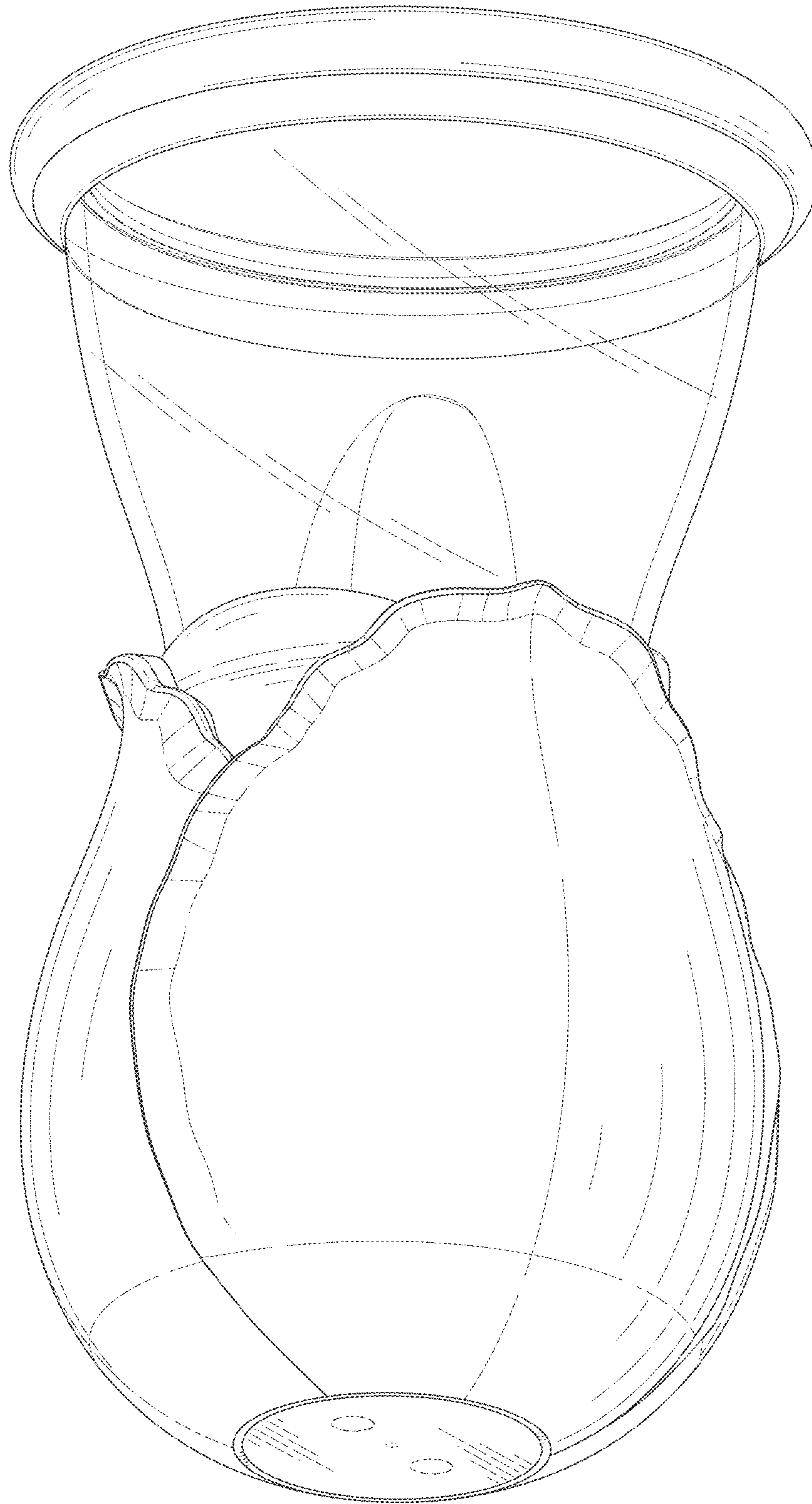

FIG. 10



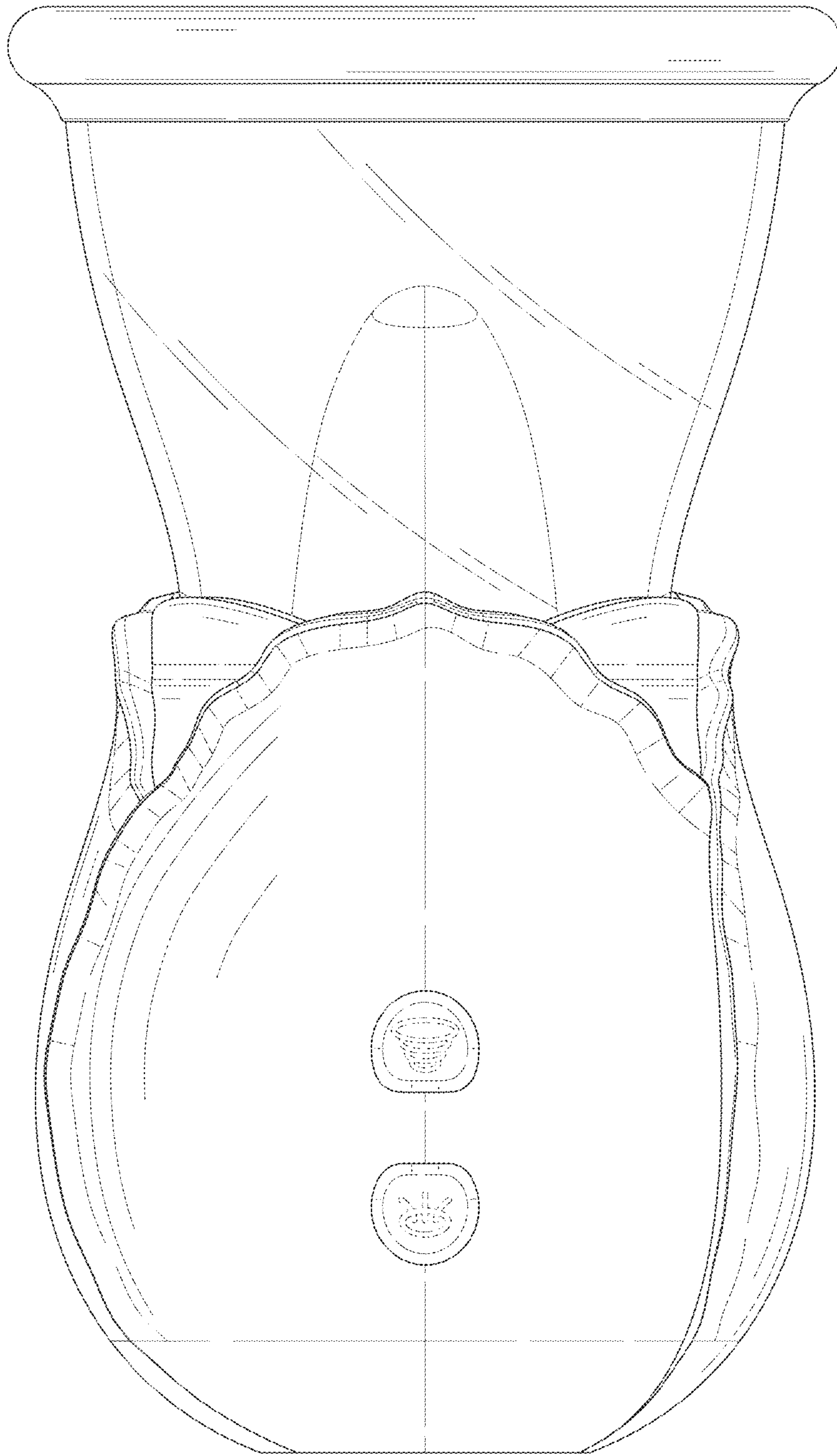

FIG. 11

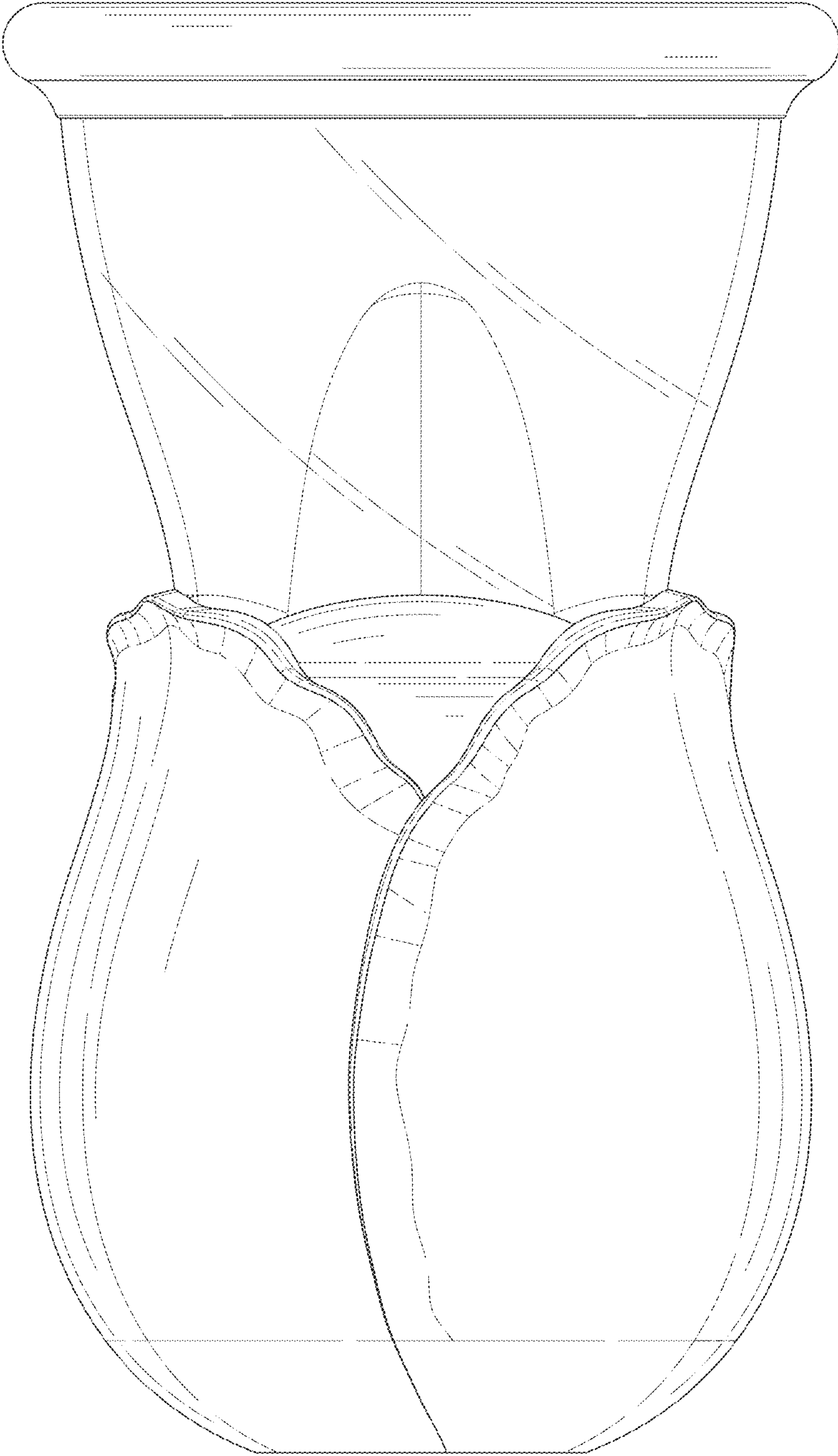

FIG. 12

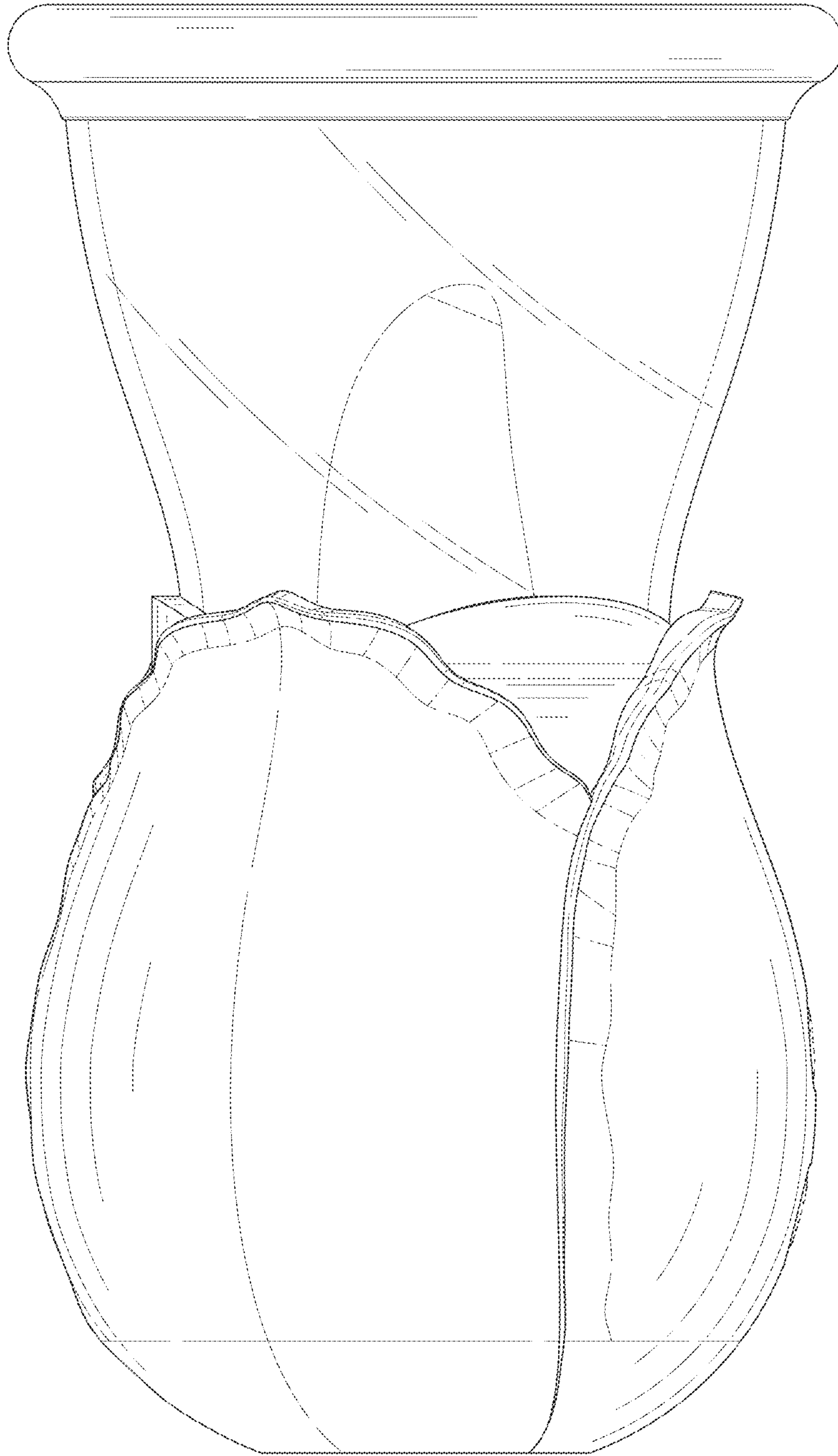

FIG. 1.3

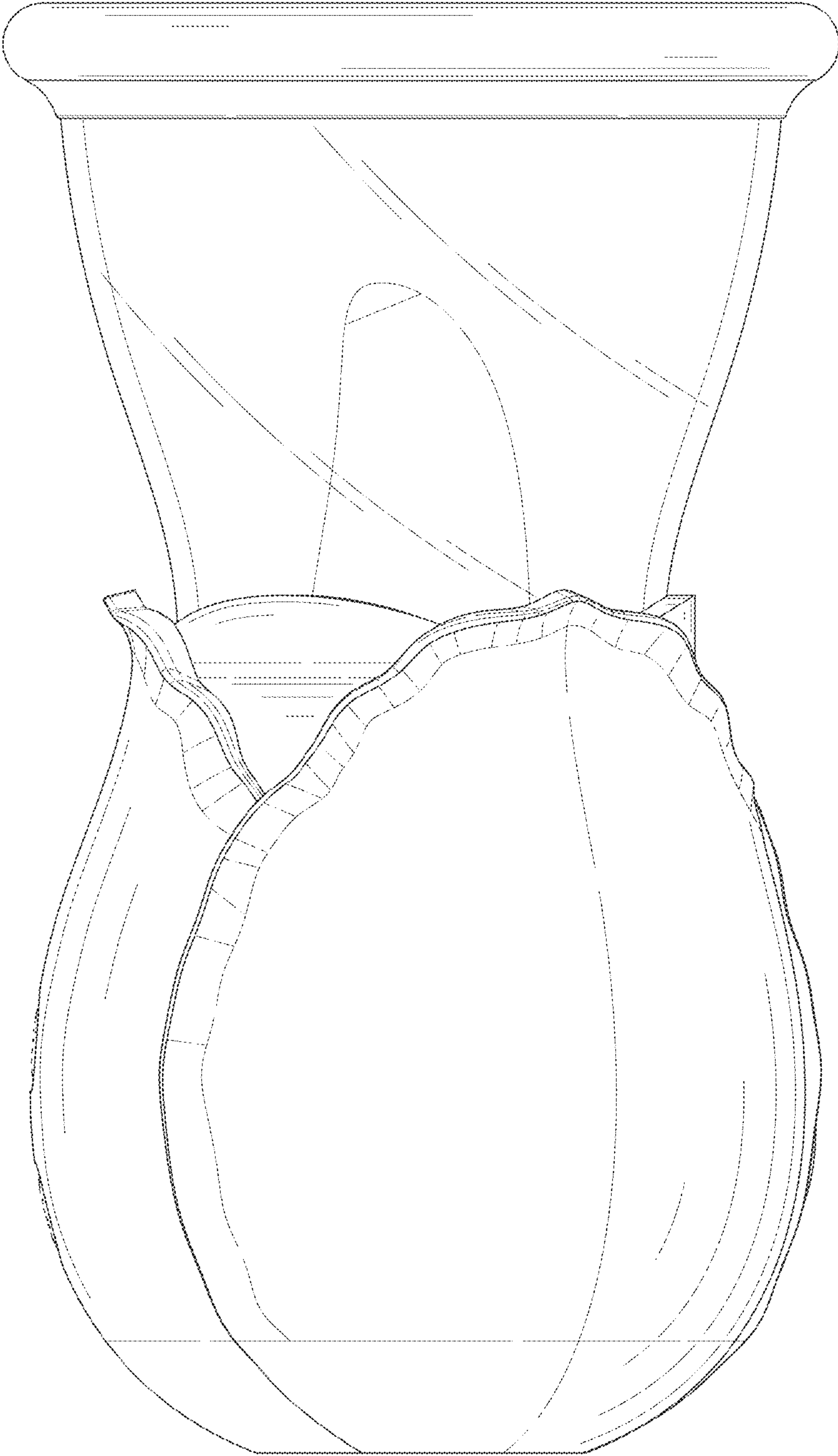

FIG. 14



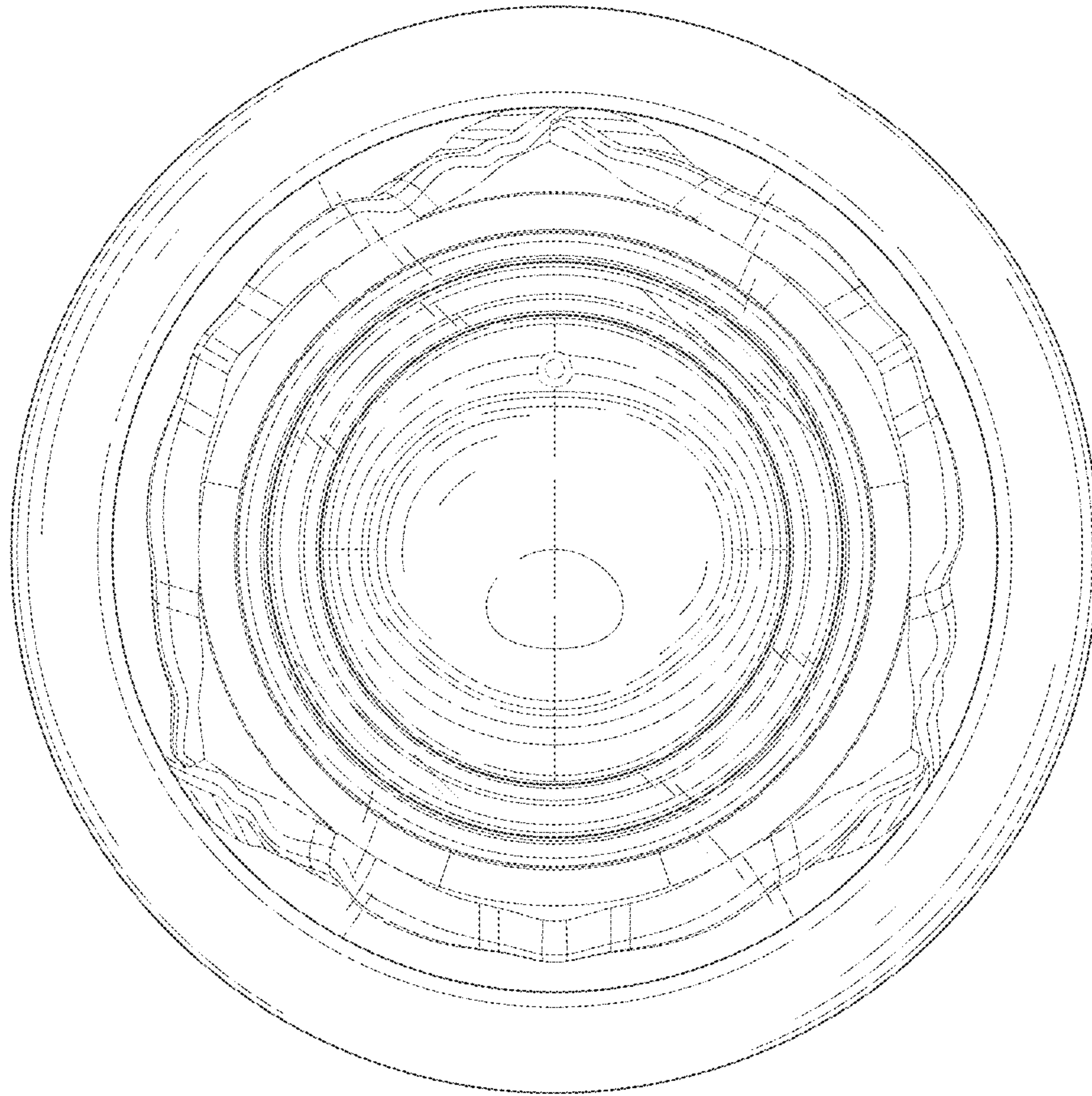

FIG. 15

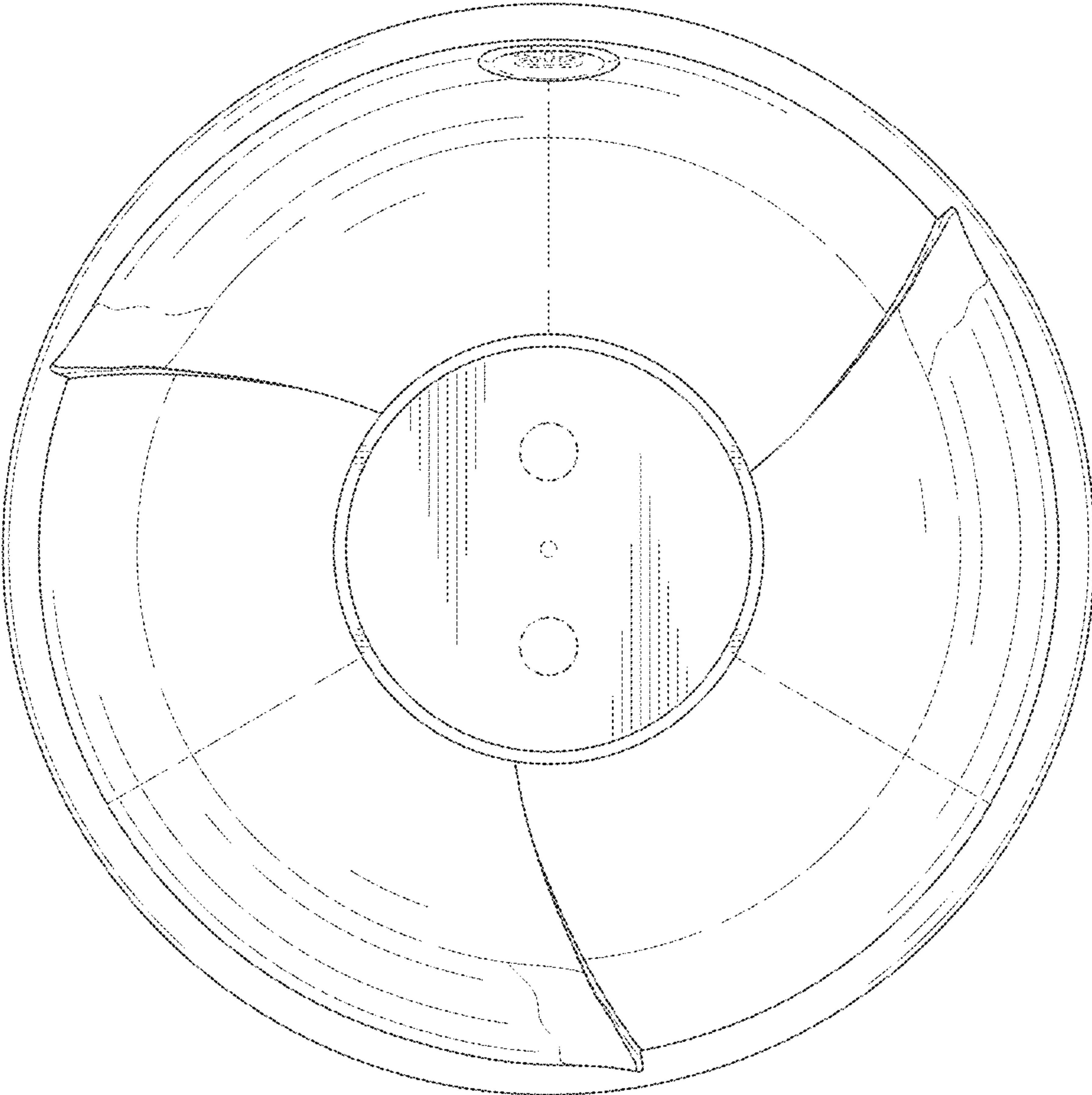

FIG. 16