



US00D977584S

(12) **United States Design Patent**  
**Dai**

(10) **Patent No.:** **US D977,584 S**  
(45) **Date of Patent:** **\*\* Feb. 7, 2023**

- (54) **UNICORN SHAPED TOY**
- (71) Applicant: **ShenZhen YiHong Technology Co., LTD, Guangdong (CN)**
- (72) Inventor: **Yi Dai, ShenZhen (CN)**
- (73) Assignee: **ShenZhen YiHong Technology CO., LTD, ShenZhen (CN)**
- (\*\*) Term: **15 Years**
- (21) Appl. No.: **29/842,915**
- (22) Filed: **Jun. 16, 2022**
- (51) **LOC (14) Cl.** ..... **21-01**
- (52) **U.S. Cl.**  
USPC ..... **D21/468; D21/620**
- (58) **Field of Classification Search**  
USPC ..... D21/398, 468, 455, 475, 478, 479, 480, D21/483, 489, 491, 499, 500, 334, 350, D21/338, 340, 341, 342, 365, 366, 303, D21/576, 620; D9/757, 762; D24/193, D24/194, 195; D19/60, 136–139; D3/207, 208, 211  
CPC ..... A63H 1/00; A63H 33/18; A63H 33/00; A63H 33/001; A63H 33/32; A63H 33/002; A63H 37/005; A63F 3/00694; A63F 3/00176; A63F 3/00697; A63F 3/00214; A63F 9/00; A63F 9/0001; A63F 9/10; A63F 9/12; A63F 9/0811; A63F 2003/00943; A63F 2003/00182; A63F 2003/00255; A63F 2003/00832; A63F 2003/00839; A63B 23/16  
See application file for complete search history.

(56) **References Cited**  
U.S. PATENT DOCUMENTS

- D700,252 S \* 2/2014 Lo ..... D21/620
- D909,827 S 2/2021 Dixon
- D921,118 S 6/2021 Yu
- D924,980 S 7/2021 Yu

- D930,084 S 9/2021 Ye
  - D937,358 S 11/2021 Chen
  - D937,359 S 11/2021 Chen
- (Continued)

**OTHER PUBLICATIONS**

HiUnicorn Big Unicorn Fidget Toy with Popping Sounds. Date First Available: Jul. 20, 2021. Retrieved from internet: <<https://www.amazon.com.au/HiUnicorn-Unicorn-Rainbow-Poppers-Educational/dp/B099F42J27>> [site visited Oct. 12, 2022] (Year: 2021).\*

(Continued)

*Primary Examiner* — Katherine Glennon  
*Assistant Examiner* — Yuan Yuan  
(74) *Attorney, Agent, or Firm* — iPA & iPM

(57) **CLAIM**

The ornamental design for a unicorn shaped toy, as shown and described.

**DESCRIPTION**

FIG. 1 is a perspective view of a first embodiment of a unicorn shaped toy showing my new design;  
FIG. 2 is a perspective view from behind thereof;  
FIG. 3 is a front view thereof;  
FIG. 4 is a back view thereof;  
FIG. 5 is a left side view thereof;  
FIG. 6 is a right side view thereof;  
FIG. 7 is a top view thereof;  
FIG. 8 is a bottom view thereof;  
FIG. 9 is a perspective view of a second embodiment of the unicorn shaped toy;  
FIG. 10 is a perspective view from behind thereof;  
FIG. 11 is a front view thereof;  
FIG. 12 is a back view thereof;  
FIG. 13 is a left side view thereof;  
FIG. 14 is a right side view thereof;  
FIG. 15 is a top view thereof; and,  
FIG. 16 is a bottom view thereof.

**1 Claim, 11 Drawing Sheets**

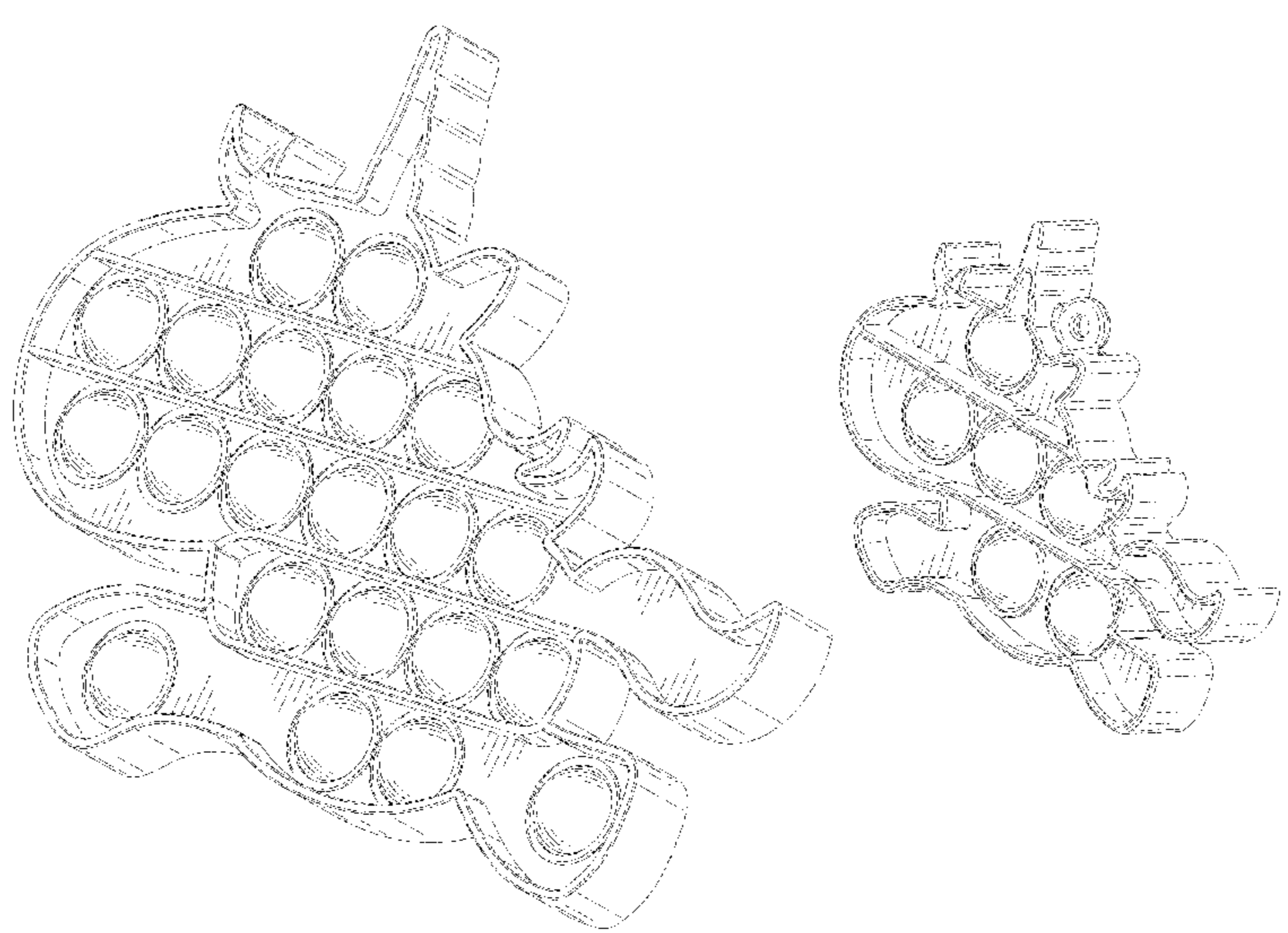

(56)

**References Cited**

## U.S. PATENT DOCUMENTS

D939,635	S	12/2021	Chen	
D941,398	S	1/2022	Zhang	
D943,679	S	2/2022	Huang	
D944,332	S *	2/2022	Yu .....	D21/468
D947,953	S	4/2022	Cui	
D948,630	S *	4/2022	Yu .....	D21/468
D950,649	S *	5/2022	Deng .....	D21/468
D952,748	S *	5/2022	Li .....	D21/350
D953,440	S *	5/2022	Li .....	D21/468
D955,485	S *	6/2022	Huang .....	D21/303
D955,499	S *	6/2022	Li .....	D21/468
D956,144	S *	6/2022	MacNeal .....	D21/468
D961,004	S *	8/2022	Zeng .....	D21/468
2019/0275285	A1	9/2019	Delp	

## OTHER PUBLICATIONS

WHATOOK Florescent Push Bubble POP Sensory Fidget Unicorn Toys. Date First Available: Aug. 4, 2021. Retrieved from internet: <<https://www.amazon.co.uk/WHATOOK-Florescent-Sensory-Anti-Anxiety-Silicone/dp/B09CT1MYJR/>> [site visited Oct. 12, 2022] (Year: 2021).\*

Pop It Fidget Toy. Date First Available: May 8, 2021. Retrieved from internet: <<https://www.amazon.ca/Sensory-Anxiety-Popping-Rainbow-Unicorn/dp/B093SHH9JY/>> [site visited Sep. 20, 2022] (Year: 2021).\*

NiHealth Mini Unicorn Push Popping Bubble Fidget Sensory Toy Keychain. Date First Available: Apr. 26, 2021. Retrieved from internet: <<https://www.amazon.com.au/NiHealth-Unicorn-Popping-Sensory-Keychain/dp/B093G71JNS/>> [site visited Sep. 20, 2022] (Year: 2021).\*

\* cited by examiner

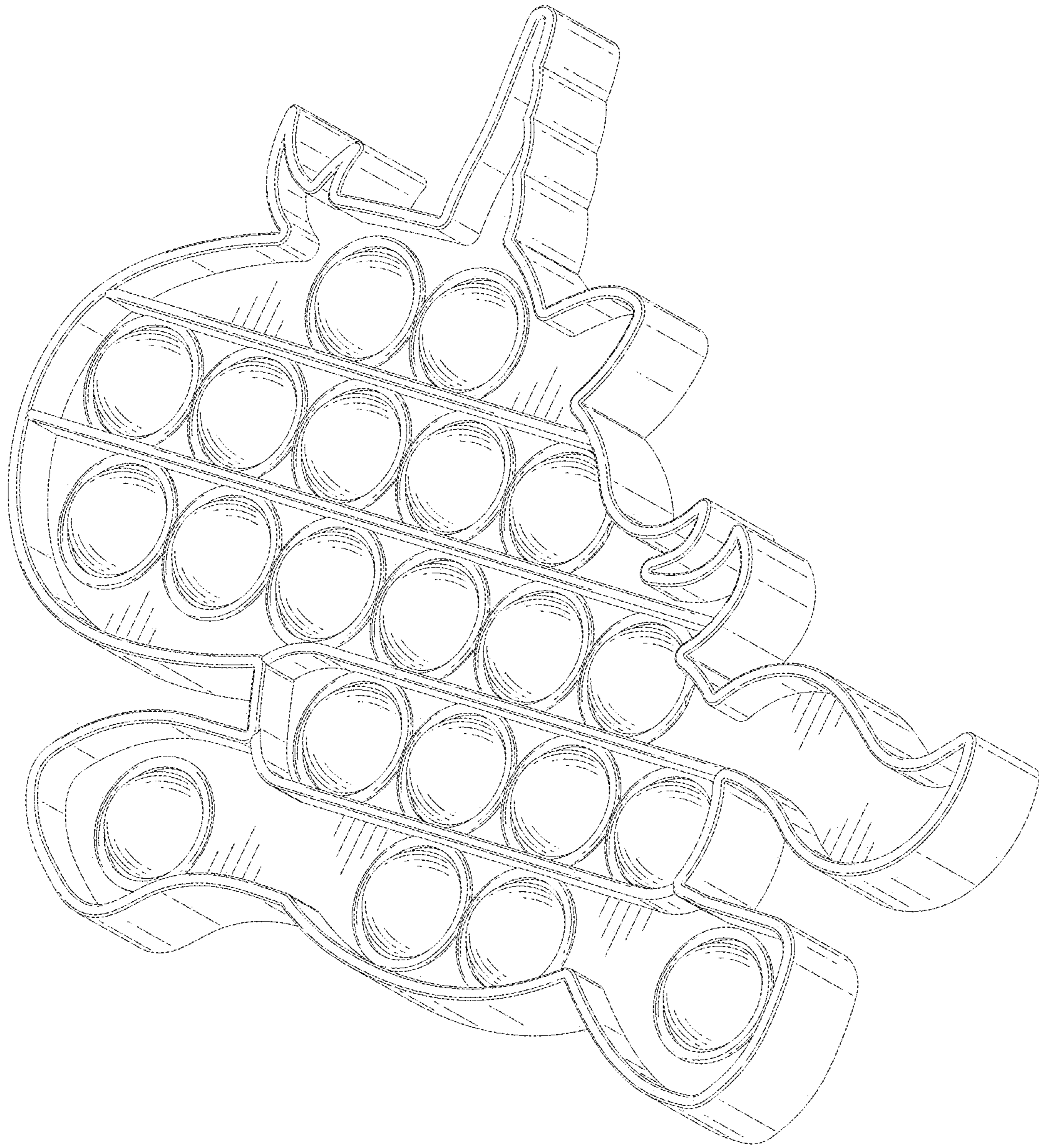

FIG. 1

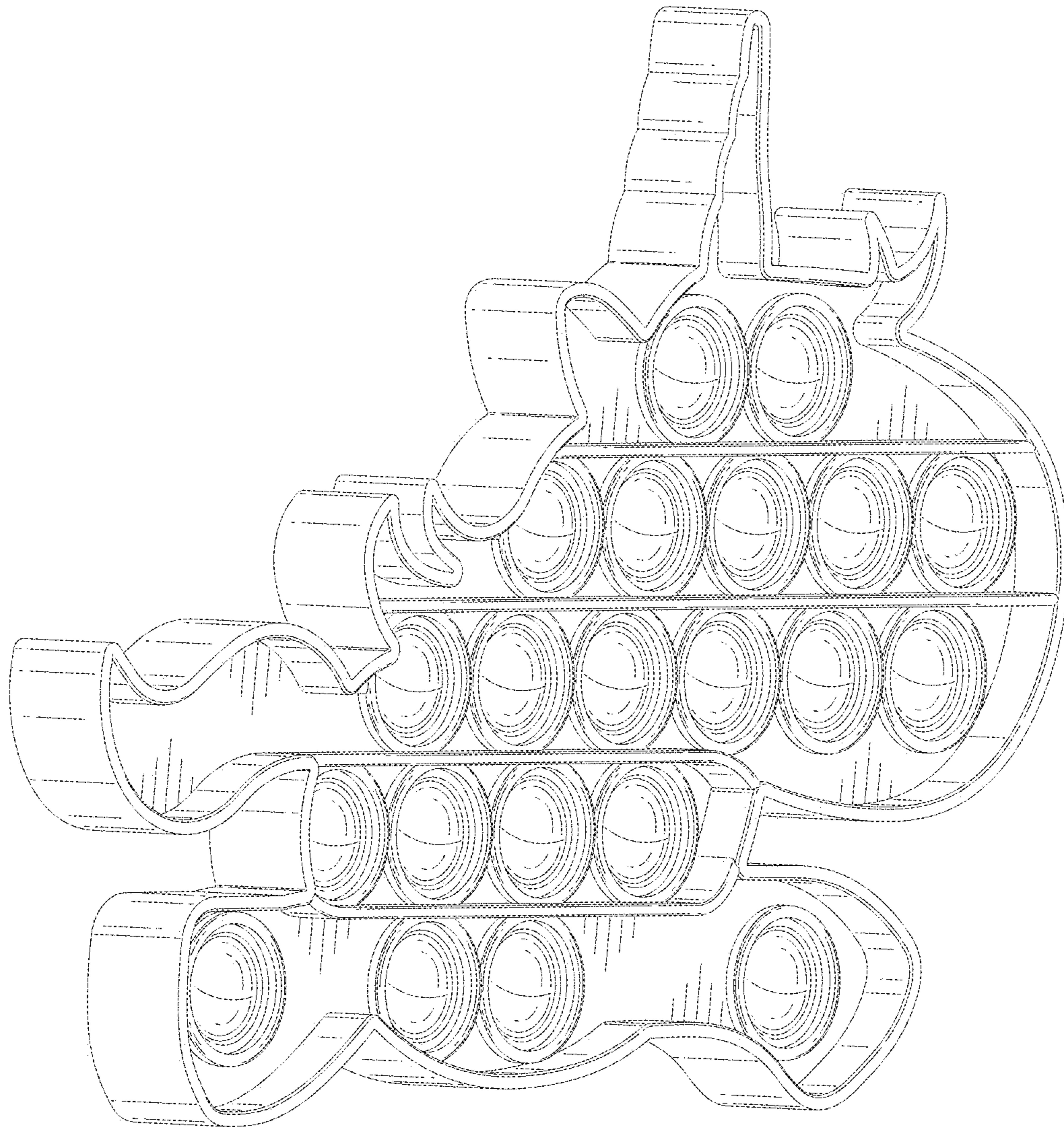

FIG. 2

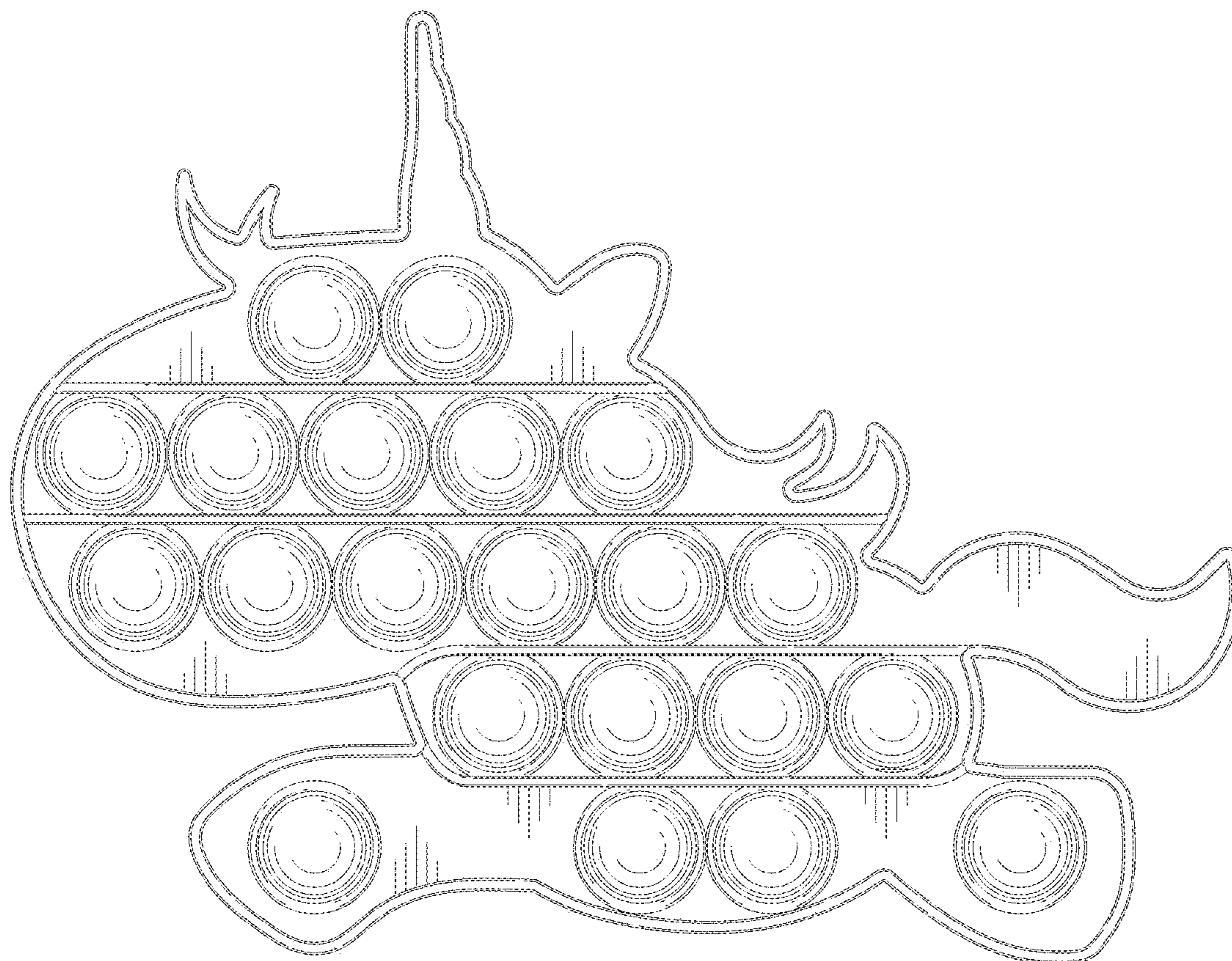

FIG. 3

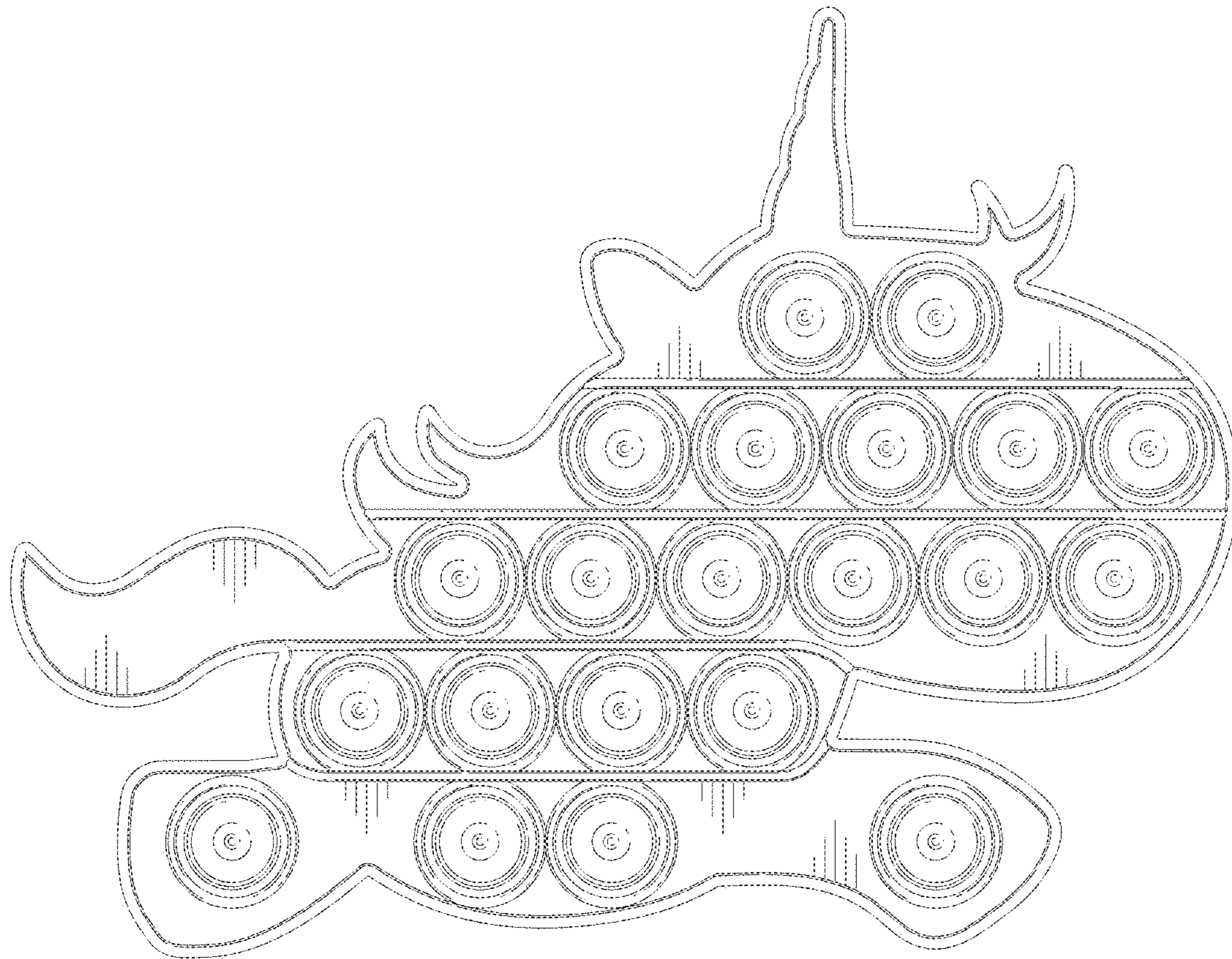

FIG. 4

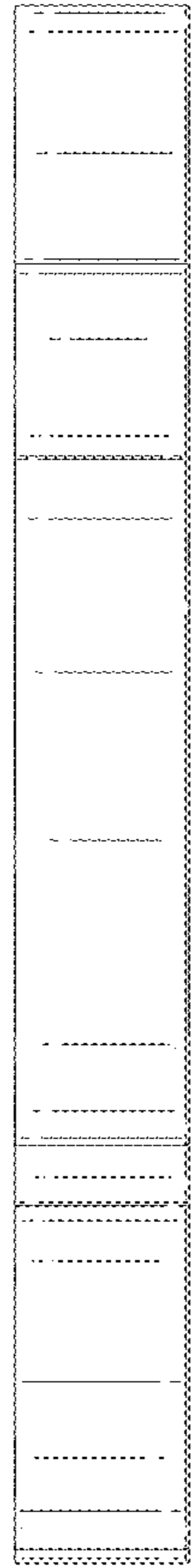

FIG. 5

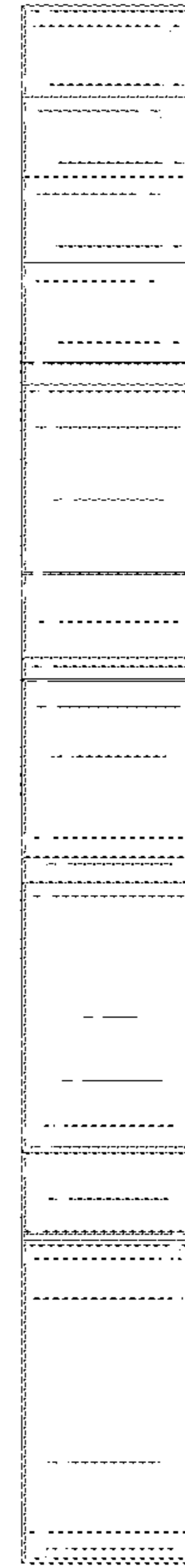

FIG. 6

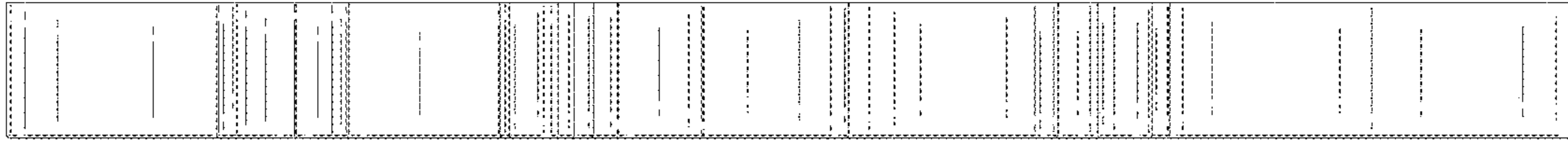

FIG. 7

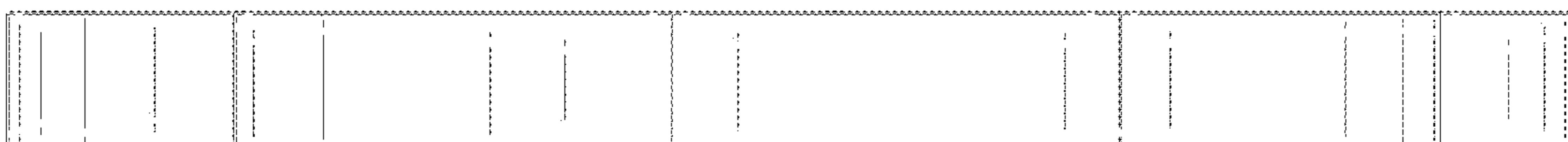

FIG. 8



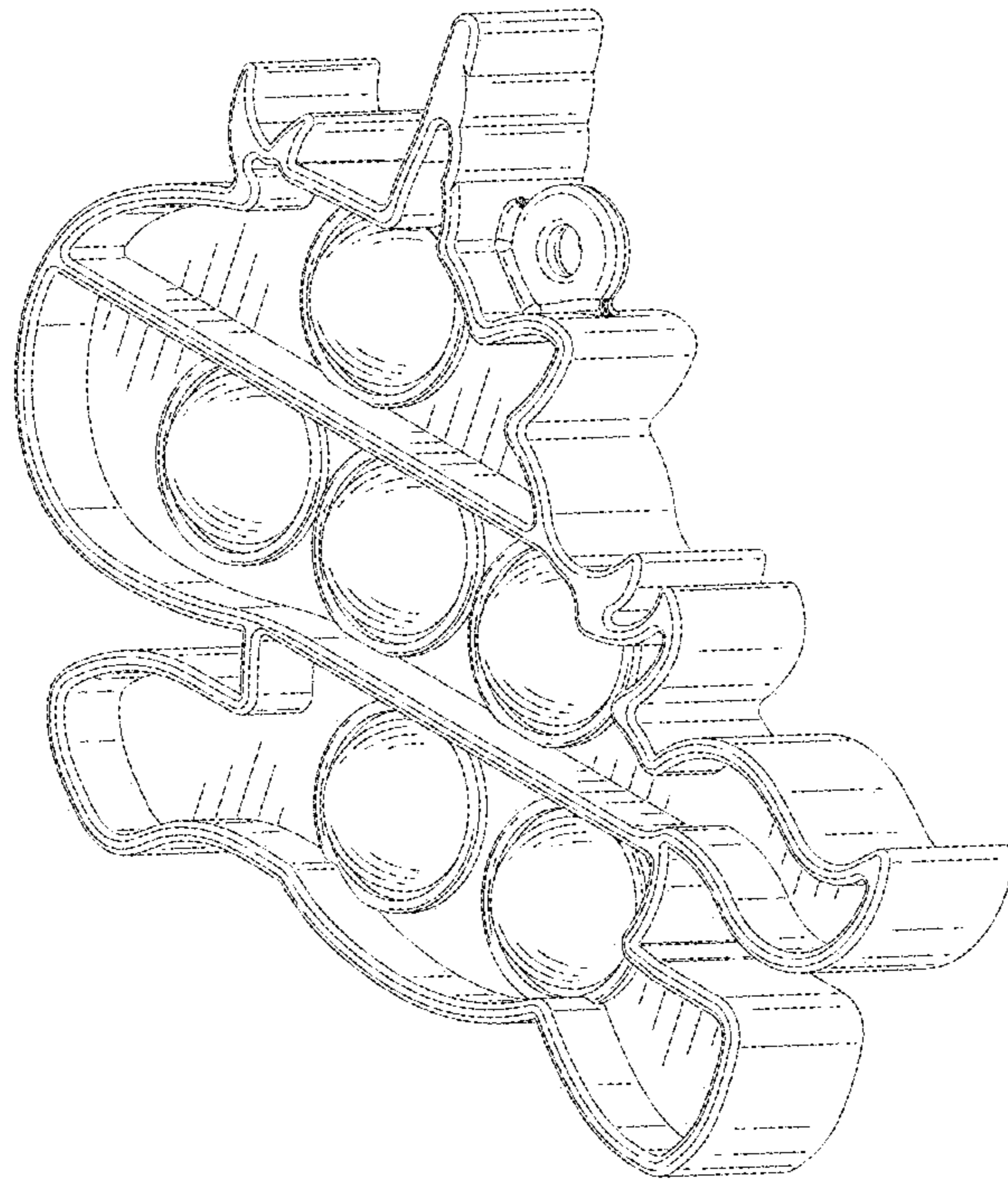

FIG. 9

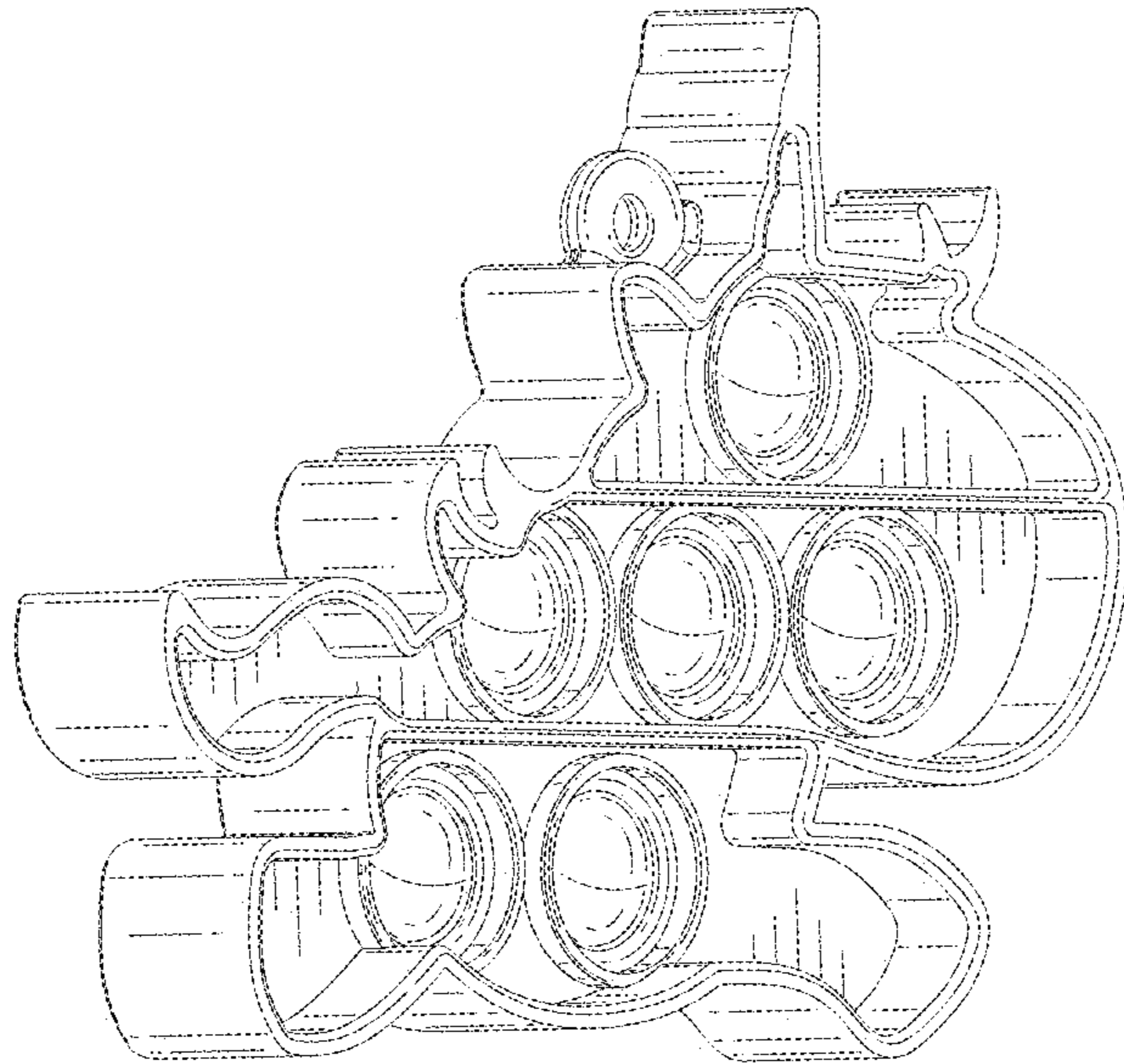

FIG.10

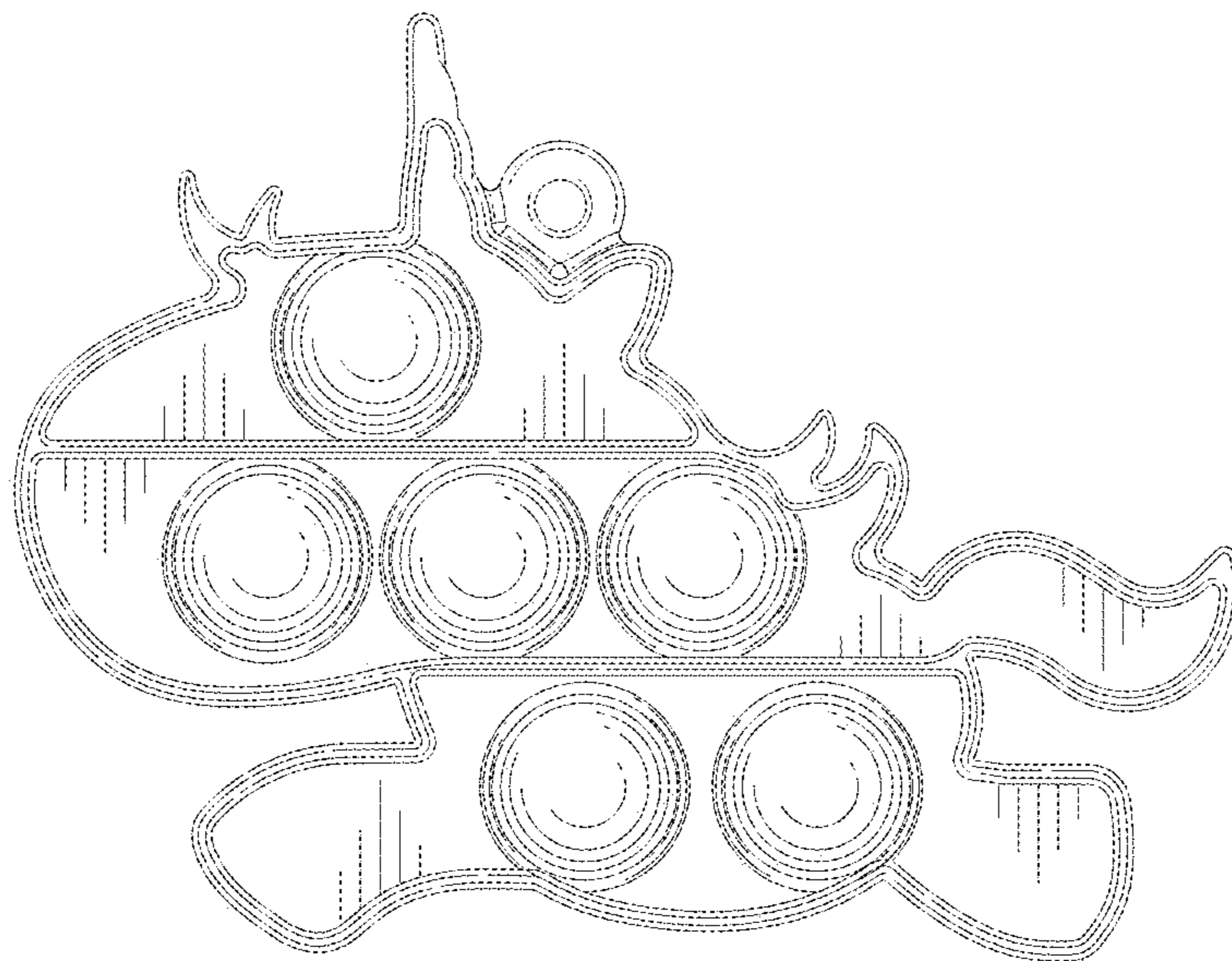

FIG.11

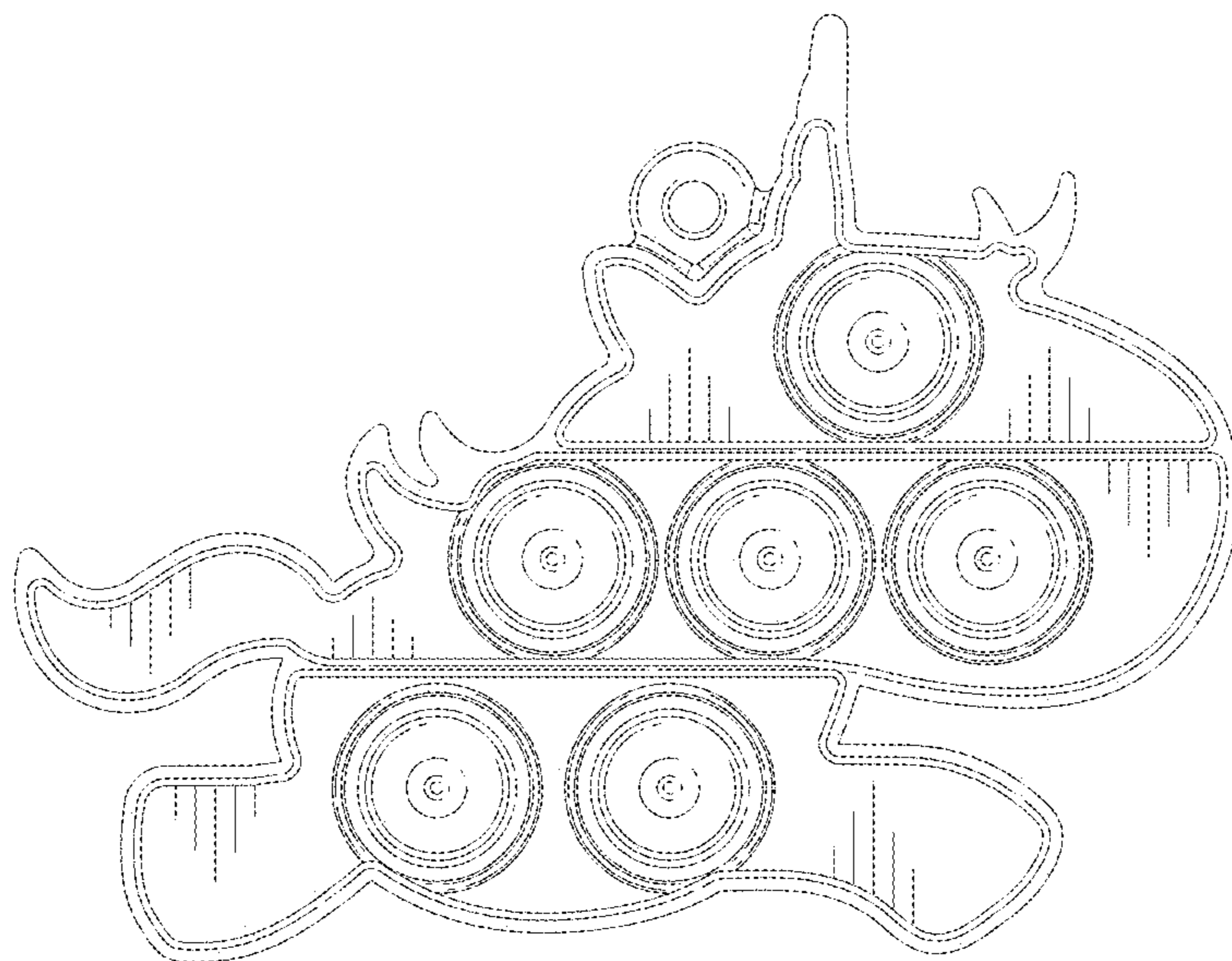

FIG.12

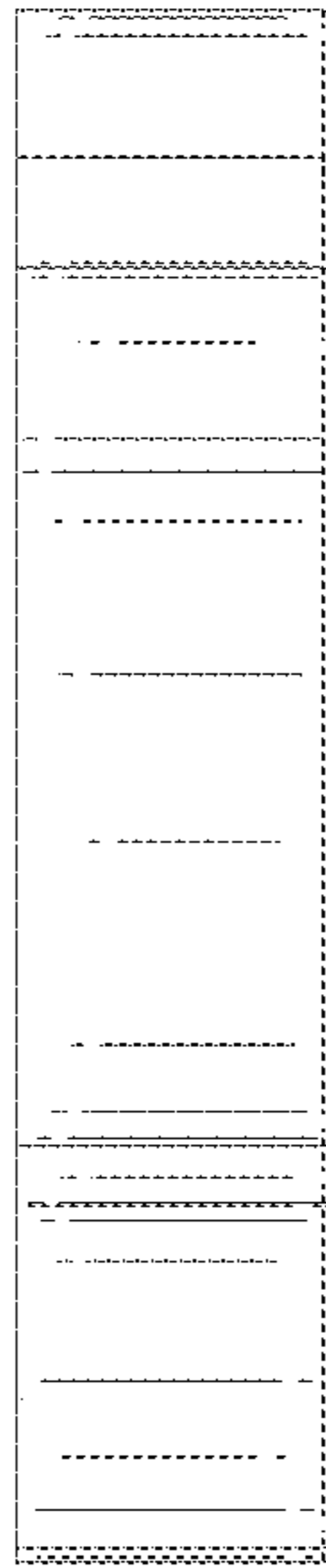

FIG.13

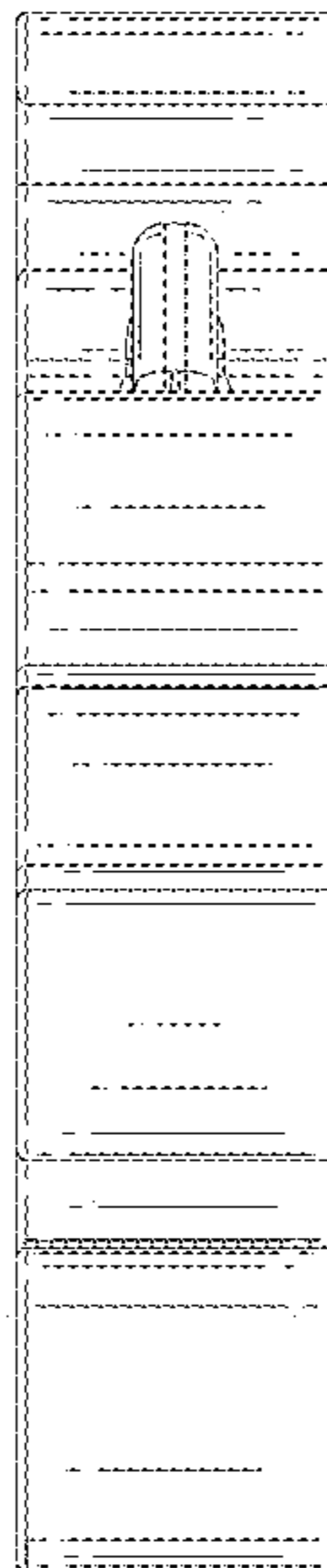

FIG.14

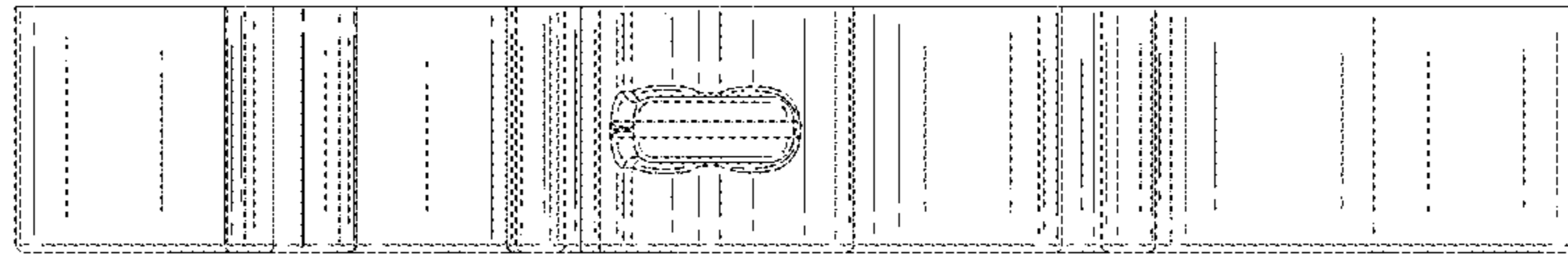

FIG.15

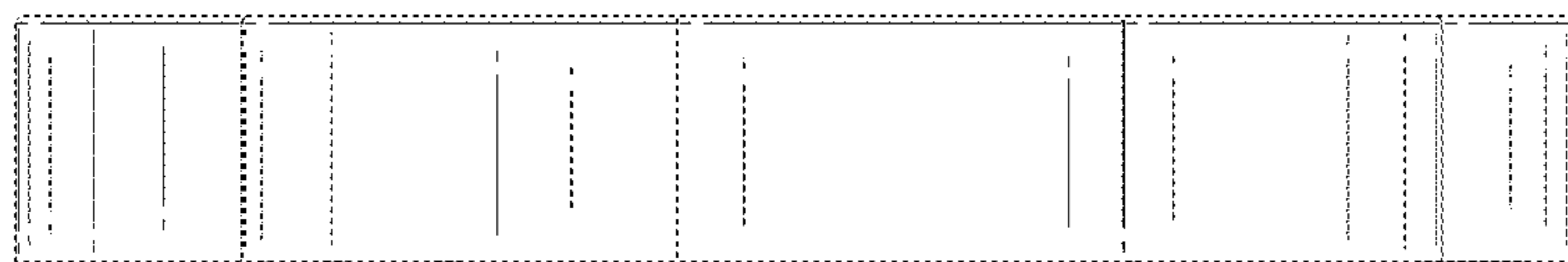

FIG.16