



US00D977569S

(12) **United States Design Patent** (10) **Patent No.:** **US D977,569 S**
Dai (45) **Date of Patent:** **** Feb. 7, 2023**

(54) **DESK ORGANIZER**

(71) Applicant: **Xi'an Dongyuemei Trading Co., Ltd.**,
Xi'an (CN)

(72) Inventor: **Danfeng Dai**, Fujian Province (CN)

(73) Assignee: **XI'AN DONGYUEMEI TRADING CO., LTD.**, Xi'an (CN)

(**) Term: **15 Years**

(21) Appl. No.: **29/847,669**

(22) Filed: **Jul. 27, 2022**

(51) **LOC (14) Cl.** **19-02**

(52) **U.S. Cl.**
USPC **D19/92**

(58) **Field of Classification Search**
USPC D19/75-92, 99, 135; D3/206, 304, 306,
D3/310, 315; D6/675, 675.1, 671.1;
D7/637-641, 600.3, 600.4; D9/432
CPC .. B43M 99/00; B43M 99/001; B43M 99/008;
B43M 99/009; B43M 99/003; B43M
99/006; B43M 99/007; A45C 11/34;
A45C 11/36; A45F 2200/0566; A45F
2200/0575; Y10S 312/902; B42D 3/12;
B42D 3/16; B42D 3/18; B43K 23/001;
B43K 23/002; A47B 55/00; A47B 63/00
See application file for complete search history.

(56) **References Cited**

U.S. PATENT DOCUMENTS

- 1,319,431 A * 10/1919 Straubel A47B 13/081
312/351
- D179,480 S * 1/1957 Jones et al. D6/671.1
- D189,040 S * 10/1960 Knudsen D6/671.1
- D258,967 S * 4/1981 Rollinson D26/58
- D261,904 S * 11/1981 Polhemus D19/92
- D267,383 S * 12/1982 Liptak D19/91

- D415,906 S * 11/1999 D'Agaro D3/297
- D456,454 S * 4/2002 Bond D19/92
- D475,225 S * 6/2003 McBrayer, Jr. D6/705.5
- D566,192 S * 4/2008 Bhavnani D19/92
- D567,864 S * 4/2008 Bhavnani D19/92
- D851,402 S * 6/2019 Best D3/304
- D875,476 S * 2/2020 Tuang D7/600.4
- D922,483 S 6/2021 Liu

FOREIGN PATENT DOCUMENTS

- CN 303666742 * 5/2016
- CN 304901578 * 11/2018

OTHER PUBLICATIONS

Wayfair. Link: <https://www.wayfair.com/storage-organization/pdp/inbox-zero-desk-organizer-w004036035.html>. Visited Nov. 30, 2022.
Desk Organizer by Inbox Zero. (Year: 2022).*

(Continued)

Primary Examiner — Lauren D McVey

(57) **CLAIM**

The ornamental design for a desk organizer, as shown and described.

DESCRIPTION

FIG. 1 is a front and top perspective view of a desk organizer, showing my new design;
FIG. 2 is a rear and bottom perspective view thereof;
FIG. 3 is a front elevation view thereof;
FIG. 4 is a rear elevation view thereof;
FIG. 5 is a left side elevation view thereof;
FIG. 6 is a right side elevation view thereof;
FIG. 7 is a top plan view thereof; and,
FIG. 8 is a bottom plan view thereof.
The broken lines in the figures illustrate portions of the desk organizer that form no part of the claimed design.

1 Claim, 8 Drawing Sheets

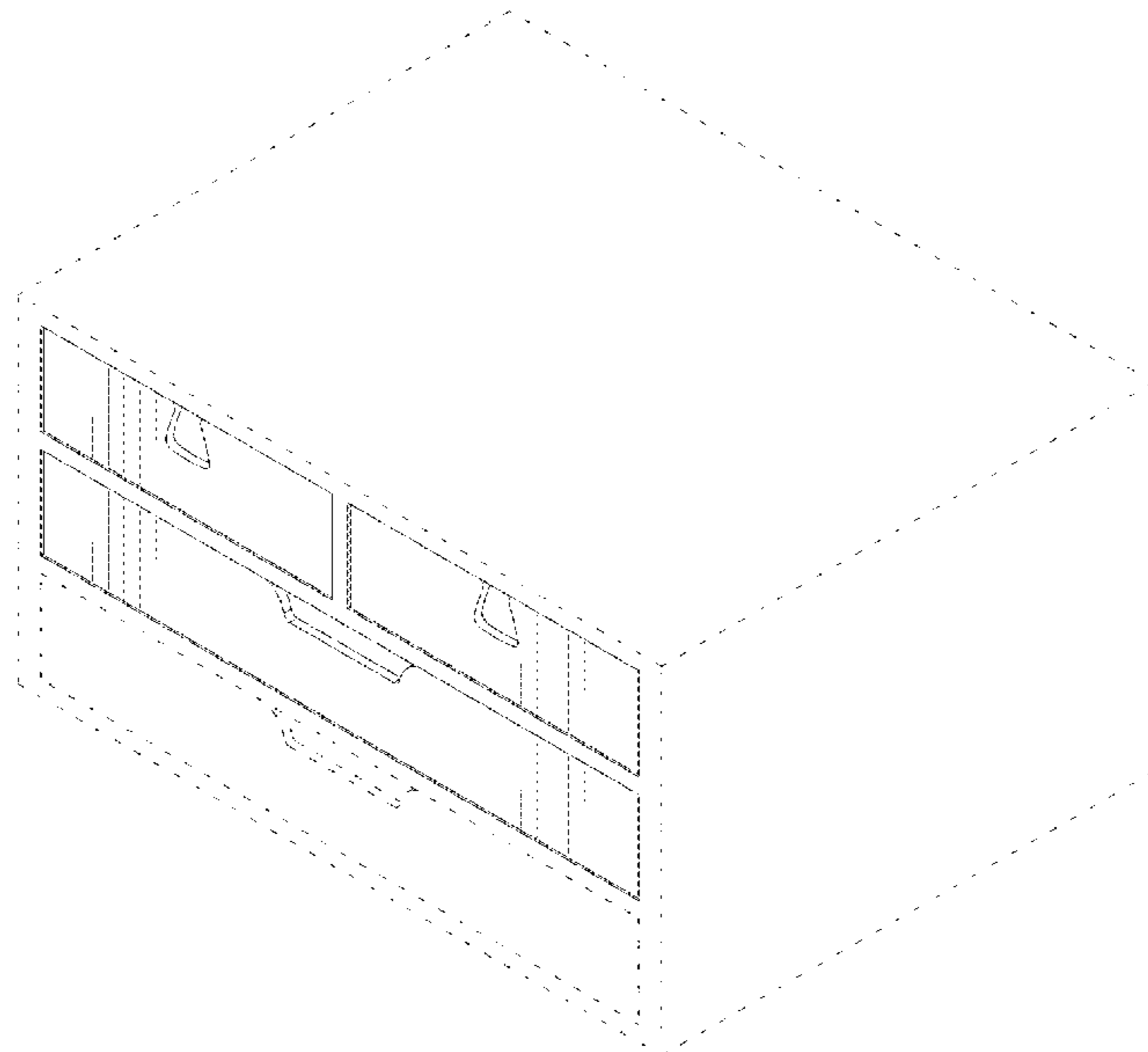

(56)

References Cited

OTHER PUBLICATIONS

Amazon. Link: https://www.amazon.com/Stackable-Solution-Supplies-toiletries-Cosmetics/dp/B07QX97MBB/ref=psdc_2422463011_t2_B07683FST1. May 12, 2019. Bamboo Drawer 2 Pack Combo Set Stackable Storage. (Year: 2019).*

Alibaba. Link: https://www.alibaba.com/product-detail/100-Natural-Bamboo-Desk-Organizer-3_1600143658519.html. Visited Nov. 30, 2022. (Year: 2022).*

Amazon. Link: https://www.amazon.com/KINGFOM-Organizer-Accessories-Stationery-Collection/dp/B00RBIW7WS/ref=asc_df_B00RBIW7WS/?tag=hyprod-20&link%2E%80%A6. Dec. 22, 2014. KINGFOM Pu Leather Desktop Organizer. (Year: 2014).*

* cited by examiner

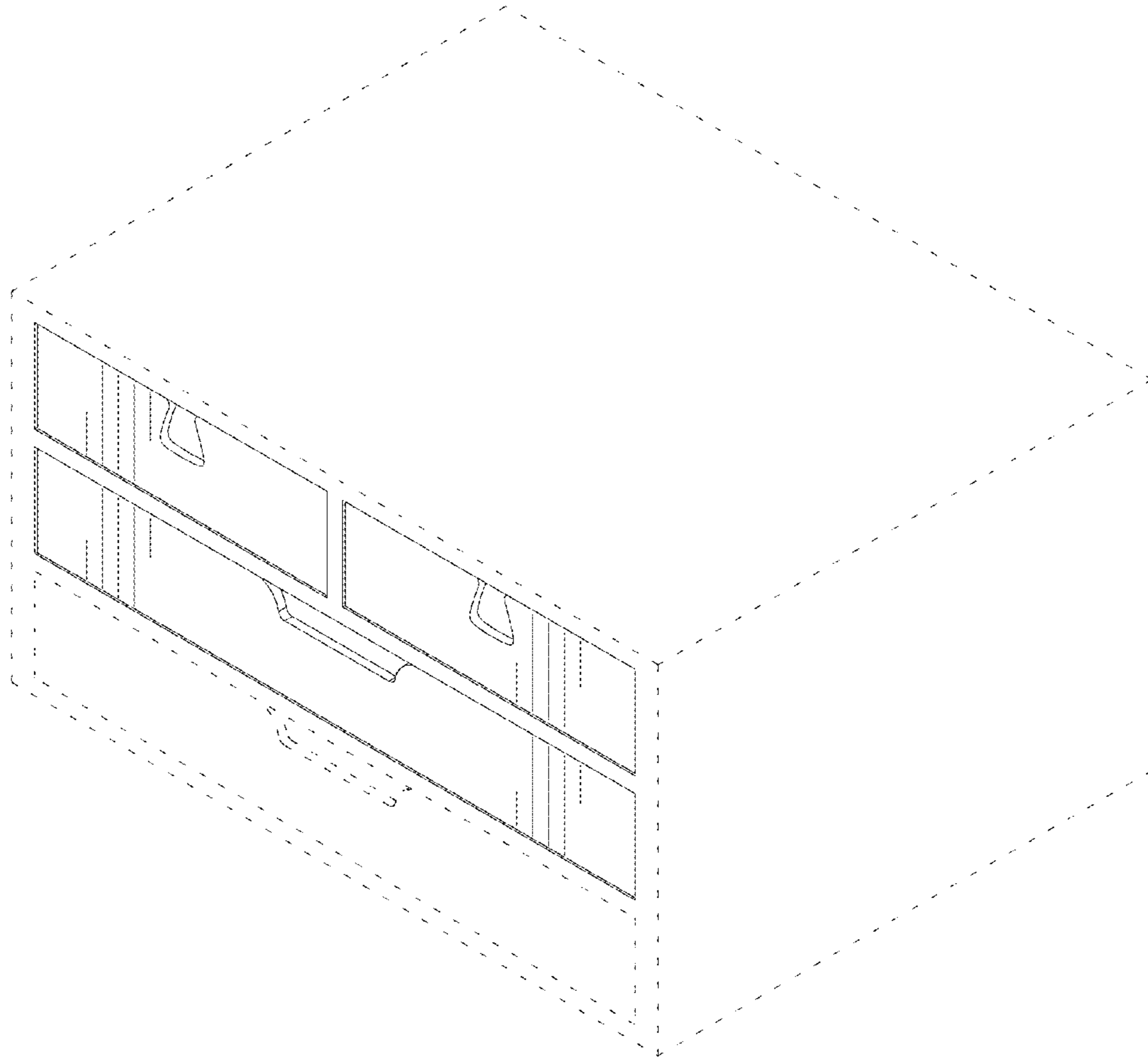

FIG.1

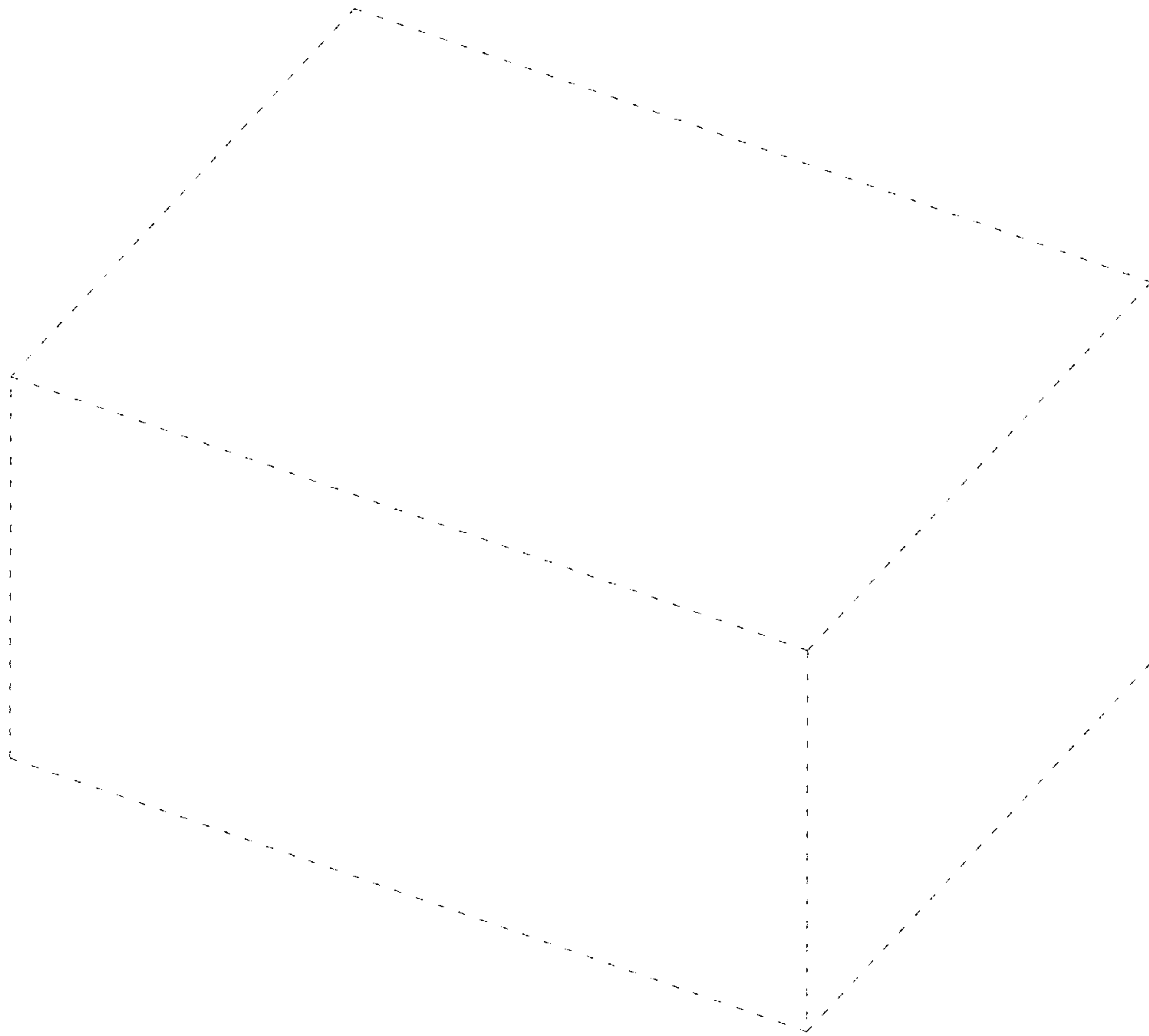

FIG.2

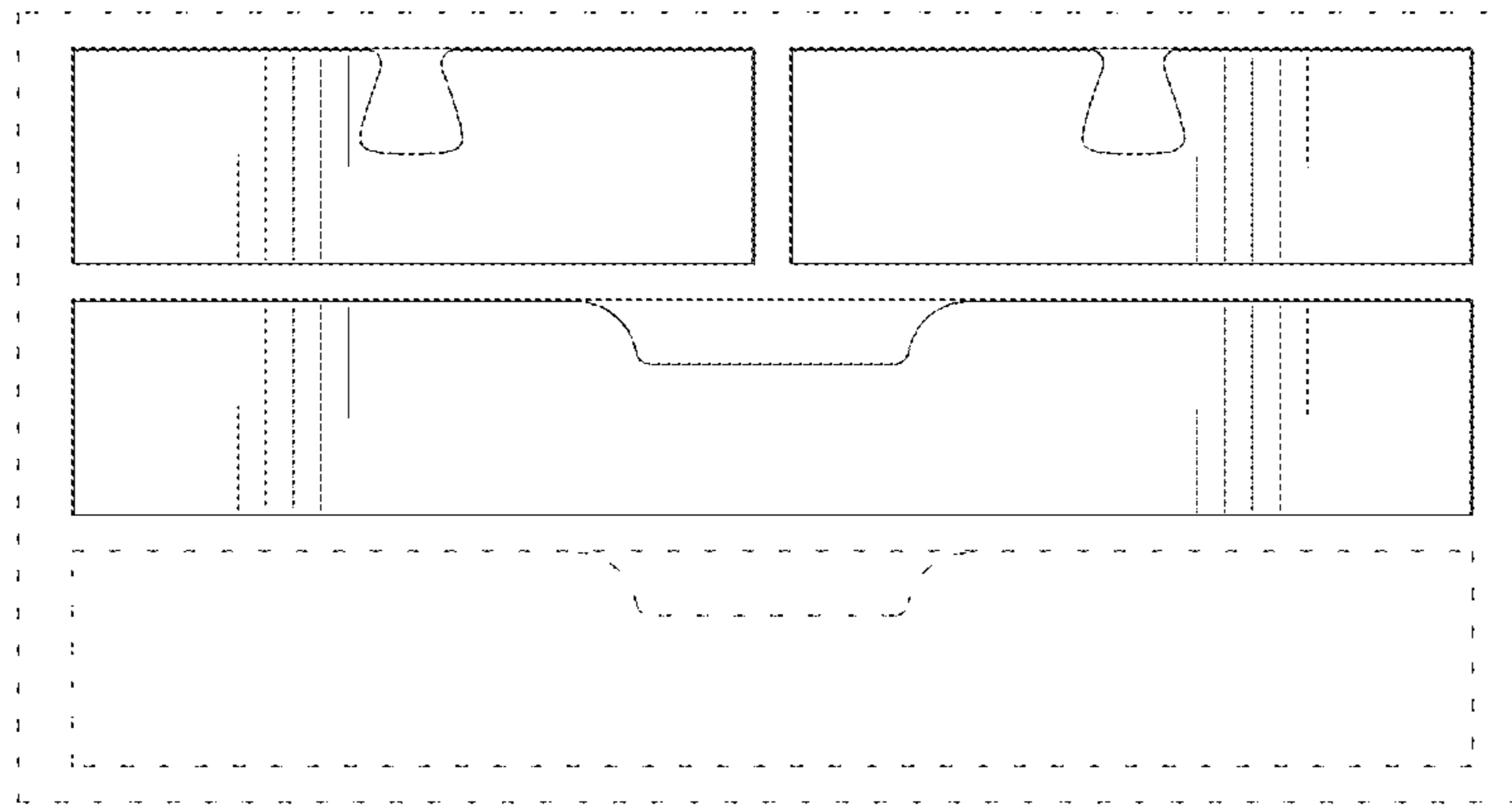

FIG.3

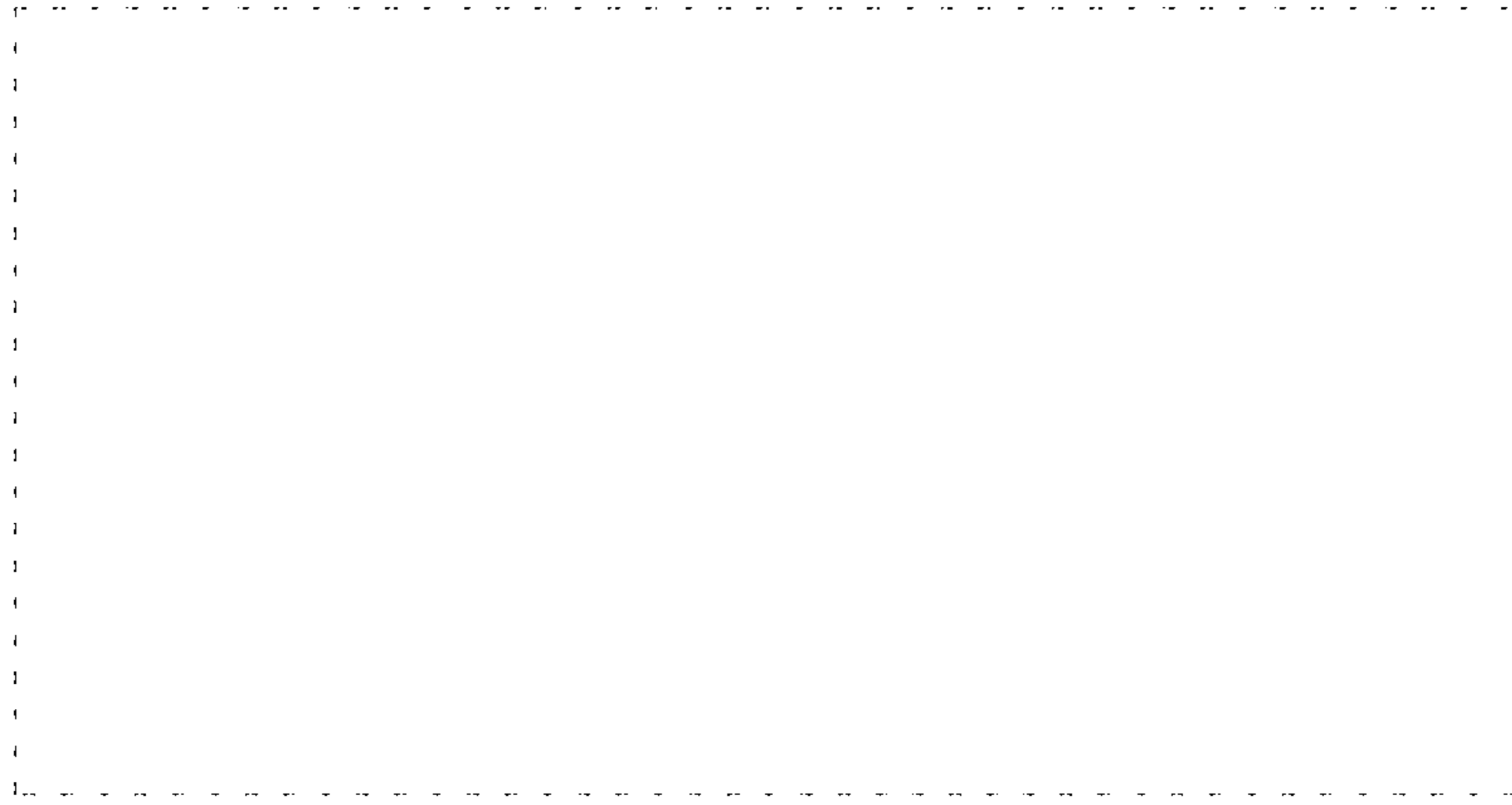

FIG.4



FIG.5



FIG.6

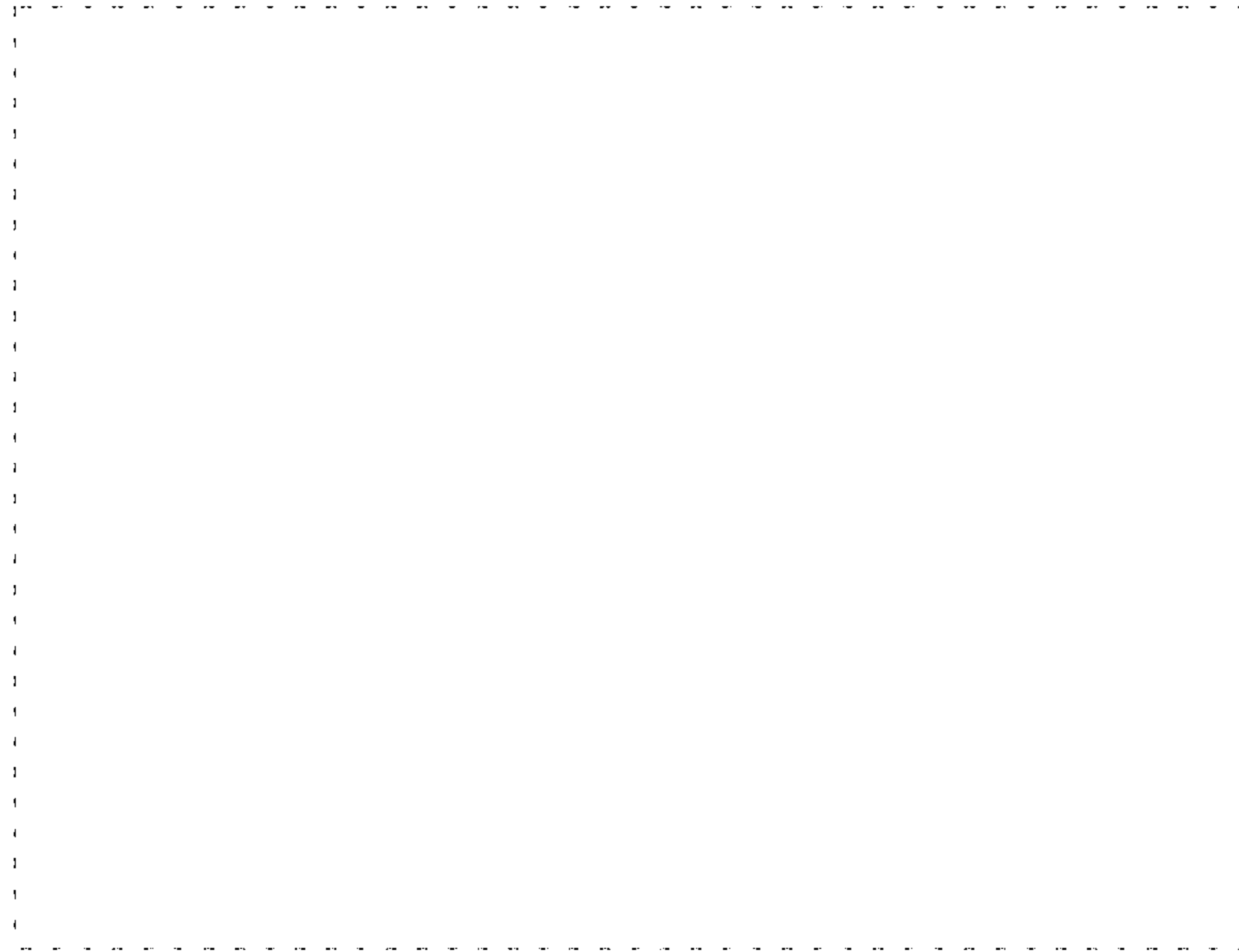

FIG.7

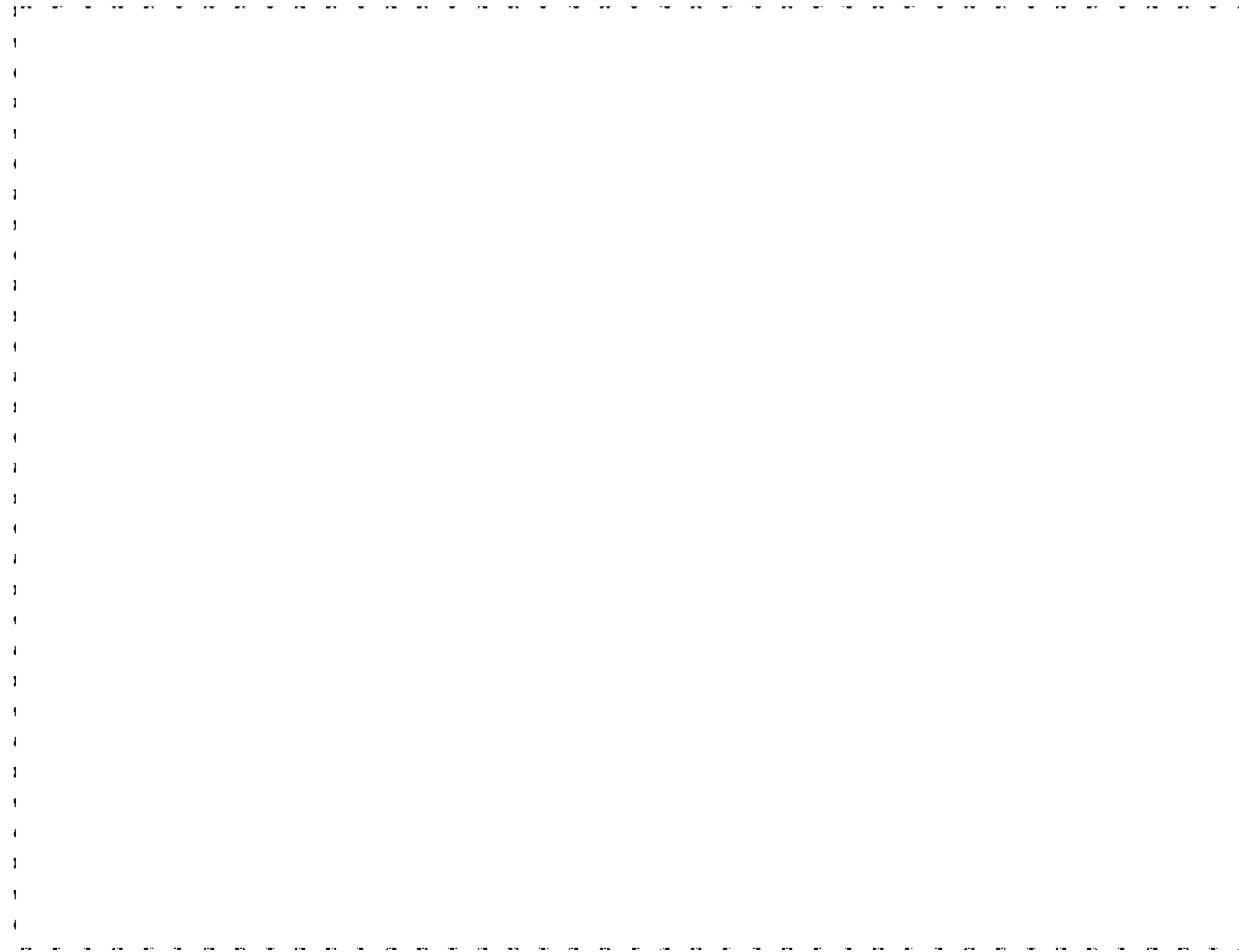

FIG.8