



US00D977450S

(12) **United States Design Patent**  
**Anstruther-Gough-Calthorpe**

(10) **Patent No.:** **US D977,450 S**

(45) **Date of Patent:** **\*\* Feb. 7, 2023**

(54) **HEADPHONES**

(71) Applicant: **TGR1.618 LIMITED**

(72) Inventor: **Jacobi Richard Penn**  
**Anstruther-Gough-Calthorpe,**  
**Winchester (GB)**

(\*\*) Term: **15 Years**

(21) Appl. No.: **29/738,655**

(22) Filed: **Jun. 18, 2020**

(51) **LOC (14) Cl.** ..... **14-01**

(52) **U.S. Cl.**

USPC ..... **D14/205; D14/206**

(58) **Field of Classification Search**

USPC ..... D14/205, 188, 192, 206; D29/112;  
2/209; D28/41; 132/273-275; 381/380,  
381/381, 370, 374; 455/90.3, 575.1,  
455/569.1

CPC ..... H04R 25/00; H04R 25/02; H04R 1/1066;  
H04R 1/1016; H04R 5/033; H04R  
5/0335; H04R 19/04; H04R 11/04; H04R  
1/08; H04R 1/1091; H04R 1/1083; H04R  
1/105

See application file for complete search history.

(56) **References Cited**

**U.S. PATENT DOCUMENTS**

4,634,816	A *	1/1987	O'Malley	.....	H04M 1/05 379/430
D316,861	S *	5/1991	Yoda	.....	D14/205
D358,388	S *	5/1995	Nakamura	.....	D14/205
5,459,290	A *	10/1995	Yamagishi	.....	H04R 1/1075 181/129
D373,360	S *	9/1996	Kanno	.....	D14/205
D375,312	S *	11/1996	Kanno	.....	D14/205
D377,021	S *	12/1996	Isono	.....	D14/205
D394,062	S *	5/1998	Chun	.....	D14/192
D399,206	S *	10/1998	Yasutomi	.....	D14/205
D404,035	S *	1/1999	Delazzer	.....	D14/206

D463,396	S *	9/2002	Beraut	.....	D14/205
6,792,122	B1 *	9/2004	Okada	.....	H04R 1/26 381/151
D504,414	S *	4/2005	Yoshida	.....	D14/192
D508,908	S *	8/2005	Chueh	.....	D14/205
D510,335	S *	10/2005	Suzuki	.....	D14/205
D540,302	S *	4/2007	Hagiwara	.....	D14/205
D540,303	S *	4/2007	Rausch	.....	D14/205
D540,335	S *	4/2007	Downs	.....	D14/455
D544,464	S *	6/2007	Lee	.....	D14/205
D557,684	S *	12/2007	Pundsack	.....	D14/205
D583,800	S *	12/2008	Jaakkola	.....	D14/205
D591,263	S *	4/2009	Shimizu	.....	D14/205
D592,640	S *	5/2009	Tkachuk	.....	D14/205

(Continued)

**FOREIGN PATENT DOCUMENTS**

EM	006538716-0003	*	5/2019
EM	008009823-0001	*	6/2020

(Continued)

*Primary Examiner* — Paula Allen Greene

(74) *Attorney, Agent, or Firm* — RC Trademark Company

(57) **CLAIM**

The ornamental design for headphones, as shown and described.

**DESCRIPTION**

FIG. 1 is a perspective view of headphones.  
FIG. 2 is a front view of the headphones of FIG. 1. The broken lines depict a portion of the headphones that form no part of the claimed design.  
FIG. 3 is a rear view of the headphones of FIG. 1.  
FIG. 4 is a right side view of the headphones of FIG. 1.  
FIG. 5 is a left side view of the headphones of FIG. 1.  
FIG. 6 is a top view of the headphones of FIG. 1; and,  
FIG. 7 is a bottom view of the headphones of FIG. 1. The broken lines depict a portion of the headphones that form no part of the claimed design.

**1 Claim, 7 Drawing Sheets**

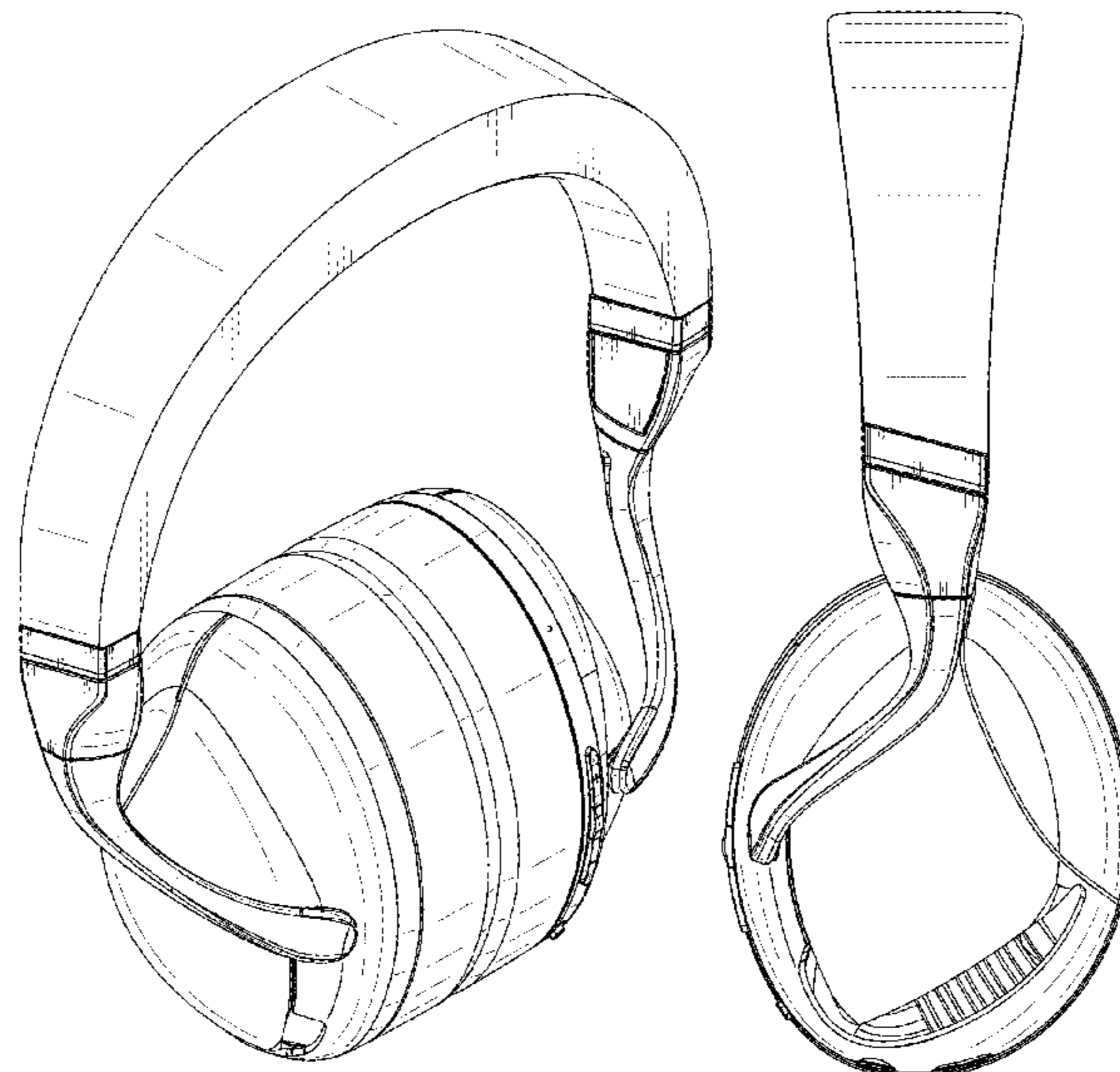

(56)

References Cited

U.S. PATENT DOCUMENTS

7,580,539 B2 \* 8/2009 Tachikawa ..... H04R 1/1066  
 381/374  
 D706,242 S \* 6/2014 Yang ..... H04R 1/1066  
 D14/205  
 D707,653 S \* 6/2014 Hardi ..... H04R 1/10  
 D14/205  
 D710,325 S \* 8/2014 Behar ..... H04R 5/033  
 D14/205  
 8,923,525 B2 \* 12/2014 Saideh ..... H04R 1/1041  
 381/74  
 D759,626 S \* 6/2016 Wagner ..... D14/205  
 D763,821 S \* 8/2016 Leopardi ..... D14/205  
 D769,218 S \* 10/2016 Mittal ..... D14/205  
 D773,434 S \* 12/2016 Wu ..... D14/205  
 D790,503 S \* 6/2017 Lok ..... D14/205  
 D806,674 S \* 1/2018 Zhang ..... D14/205  
 D809,475 S \* 2/2018 Dryden ..... D14/205  
 D826,209 S \* 8/2018 Homewood ..... D14/205  
 D829,686 S \* 10/2018 Davi ..... D14/205  
 D837,764 S \* 1/2019 Xiao ..... D14/205  
 D861,635 S \* 10/2019 Davi ..... D14/205

D862,413 S \* 10/2019 Davi ..... D14/205  
 10,616,677 B2 \* 4/2020 Bozaglo ..... H04R 5/033  
 D893,446 S \* 8/2020 Rodriguez ..... D14/192  
 D897,309 S \* 9/2020 Cho ..... D14/205  
 D910,594 S \* 2/2021 Chen ..... D14/206  
 D936,035 S \* 11/2021 Tang ..... D14/205  
 2009/0103762 A1 \* 4/2009 Ishida ..... H04R 5/0335  
 381/378  
 2016/0080853 A1 \* 3/2016 Chen ..... H04R 1/1083  
 381/74  
 2016/0165021 A1 \* 6/2016 Broadley ..... H04M 1/0258  
 455/569.1  
 2017/0019729 A1 \* 1/2017 Cochran ..... H04R 1/1091  
 2019/0230429 A1 \* 7/2019 Bozaglo ..... H04R 5/0335  
 2020/0252710 A1 \* 8/2020 Bottoni ..... H04R 1/1008  
 2021/0084400 A1 \* 3/2021 Tsubone ..... H04R 5/0335

FOREIGN PATENT DOCUMENTS

GB 9008009823-0001 \* 6/2020  
 GB 6116642 \* 8/2020  
 JP D1648078 \* 11/2019  
 JP D1702614 \* 11/2021

\* cited by examiner

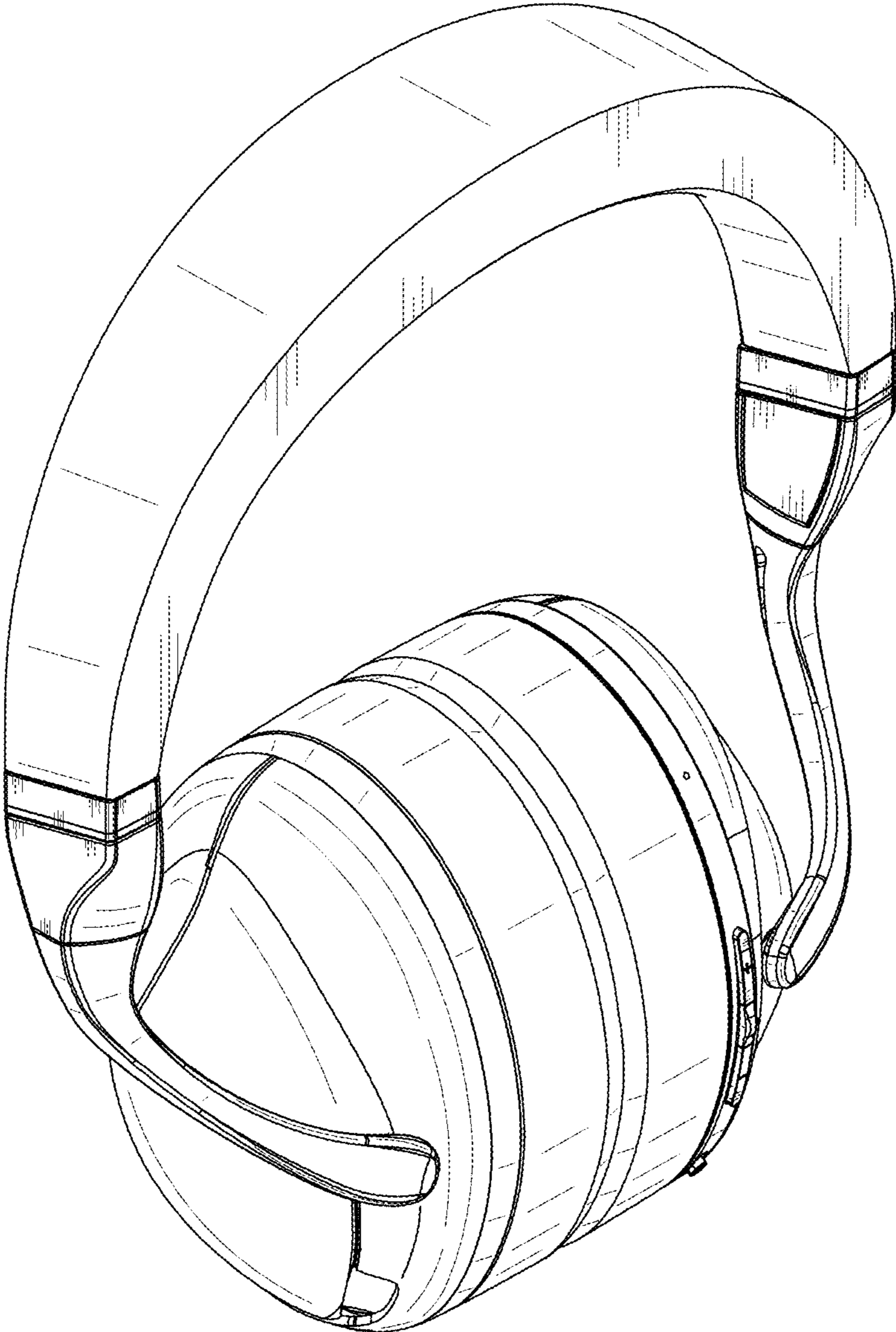

FIG. 1



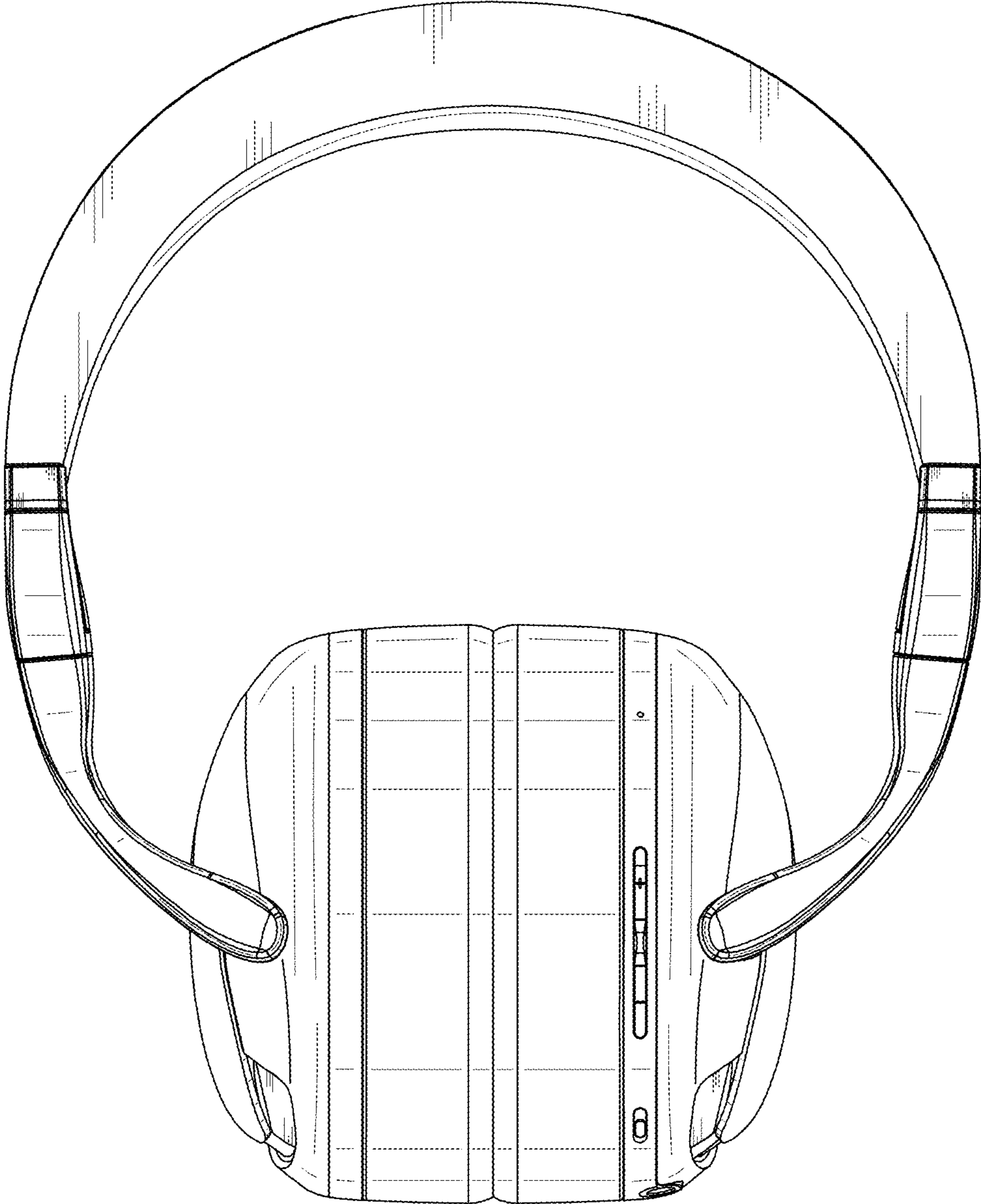

FIG. 2

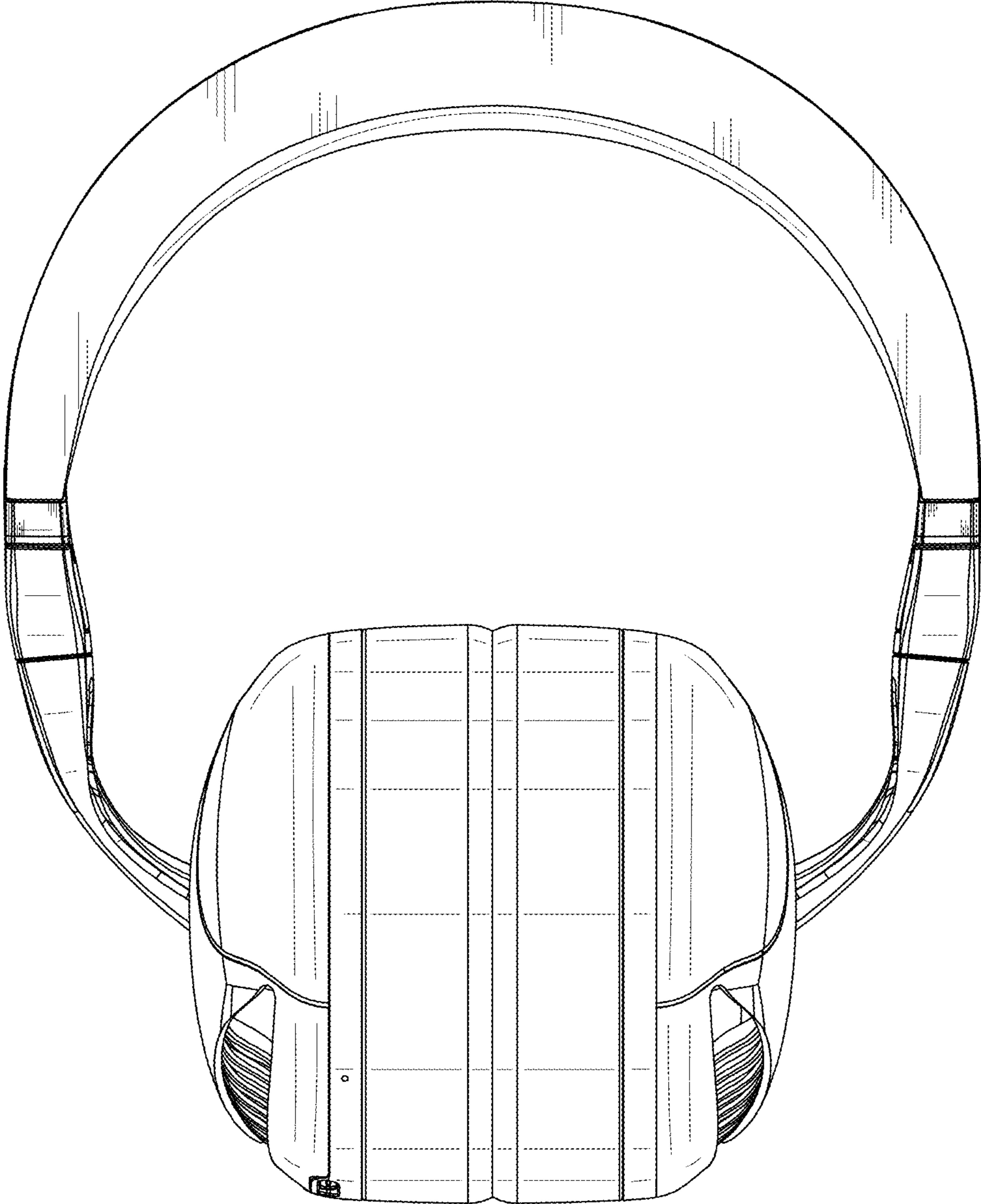

FIG. 3

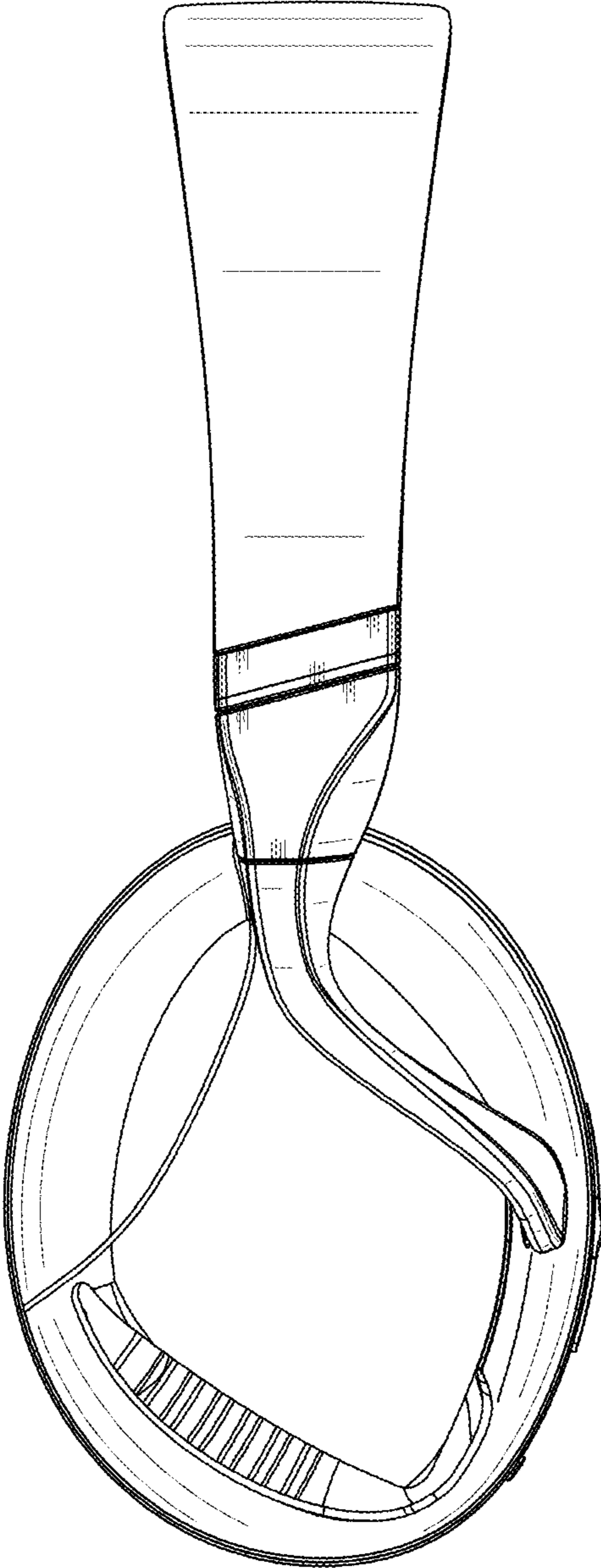

FIG. 4

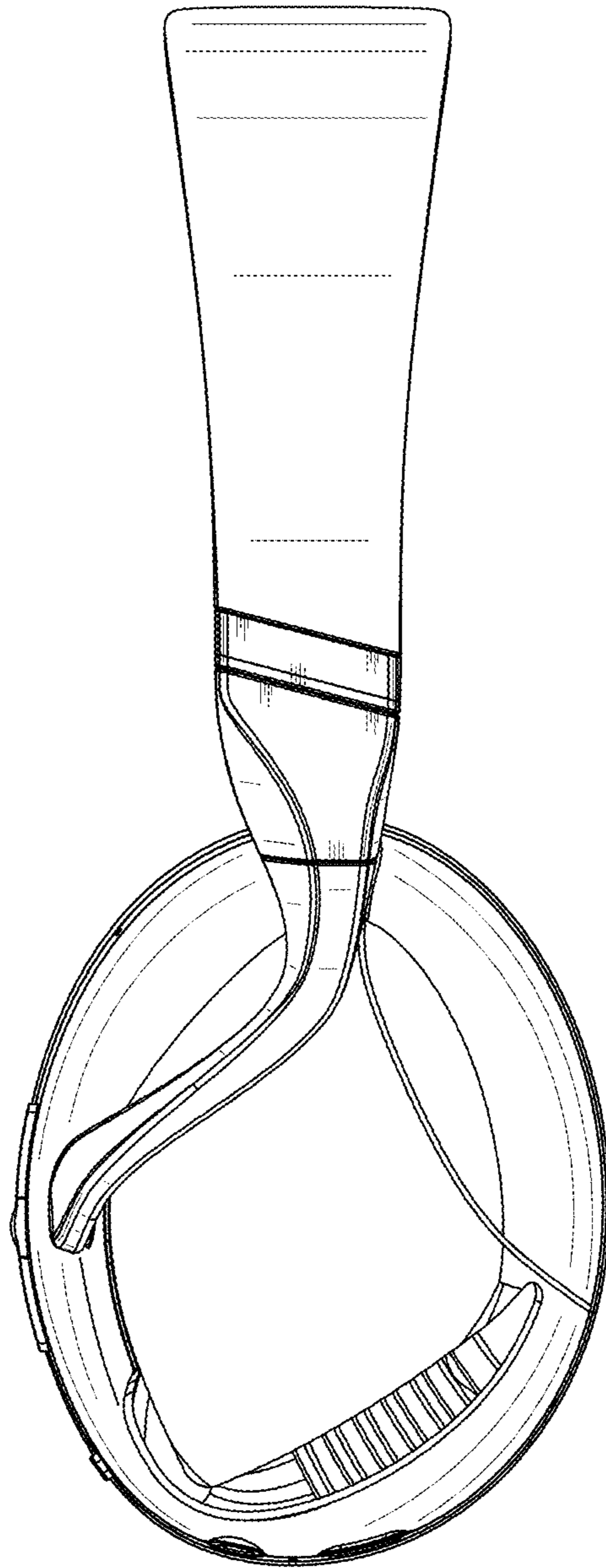

FIG. 5

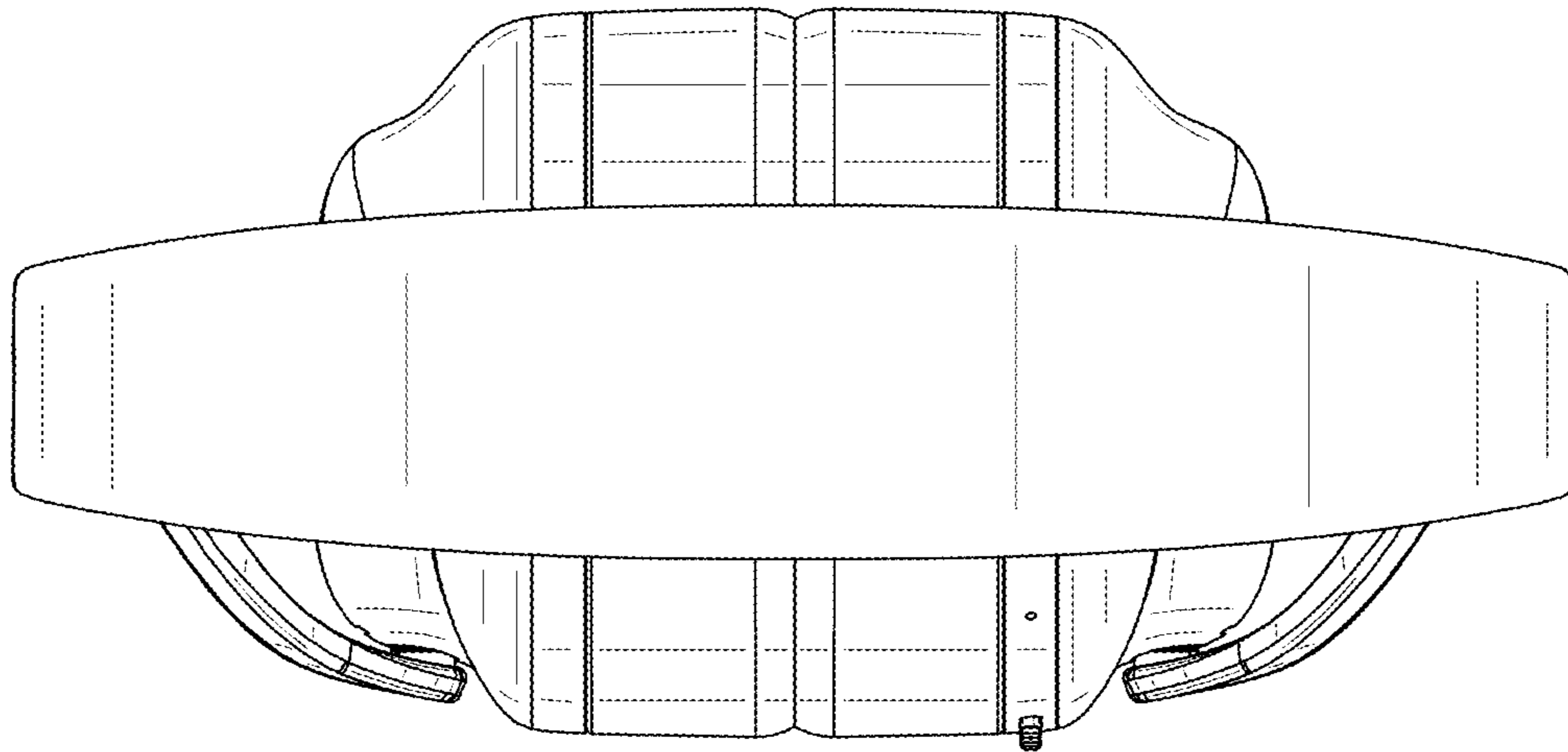

FIG. 6



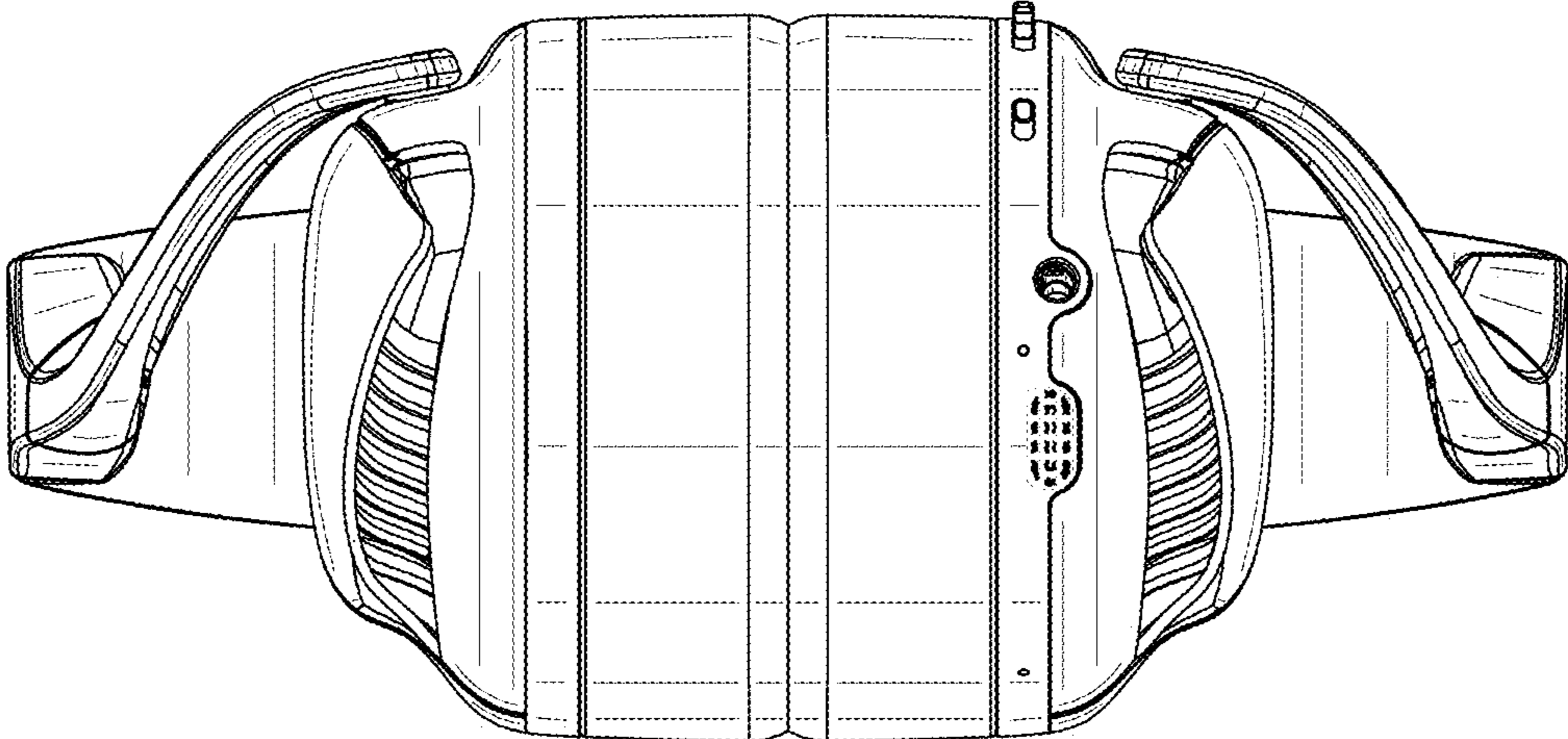

FIG. 7