



US00D977381S

(12) **United States Design Patent** (10) **Patent No.:** **US D977,381 S**
Lee et al. (45) **Date of Patent:** **** Feb. 7, 2023**

(54) **REAR BUMPER COVER FOR AUTOMOBILE**

(56) **References Cited**

(71) Applicants: **Hyundai Motor Company**, Seoul (KR); **Kia Corporation**, Seoul (KR)

U.S. PATENT DOCUMENTS

(72) Inventors: **Kwang-Jae Lee**, Gyeonggi-do (KR); **Hyo-Sung Lee**, Seoul (KR)

D684,899 S * 6/2013 Baker D12/92
D883,873 S * 5/2020 Woodhouse D12/169
D883,875 S * 5/2020 Woodhouse D12/169
D918,794 S * 5/2021 Choi D12/169
D938,866 S * 12/2021 Theis D12/169
D950,436 S * 5/2022 Chen D12/169

(73) Assignees: **Hyundai Motor Company**, Seoul (KR); **Kia Corporation**, Seoul (KR)

* cited by examiner

(**) Term: **15 Years**

Primary Examiner — Melody N Brown

(21) Appl. No.: **29/786,333**

(74) *Attorney, Agent, or Firm* — Fox Rothschild LLP

(22) Filed: **May 31, 2021**

(57) **CLAIM**

The ornamental design for a rear bumper cover for automobile, as shown and described.

(30) **Foreign Application Priority Data**

DESCRIPTION

Jan. 28, 2021 (KR) 30-2021-0004725

(51) **LOC (14) Cl.** **12-16**

FIG. 1 is a front and right side perspective view of a rear bumper cover for automobile showing our new design; FIG. 2 is a front elevational view thereof; FIG. 3 is a rear elevational view thereof; FIG. 4 is a left side elevational view thereof; FIG. 5 is a right side elevational view thereof; FIG. 6 is a top plan view thereof; and, FIG. 7 is a bottom plan view thereof.

(52) **U.S. Cl.**
USPC **D12/169**

(58) **Field of Classification Search**
USPC D12/169, 196, 86, 90-92, 163, 190, 98, D12/164; 293/102, 113, 115, 117, 120, 293/193.11; 296/180.1, 180.2
CPC B60R 19/02; B60R 19/04; B62D 25/08
See application file for complete search history.

1 Claim, 7 Drawing Sheets

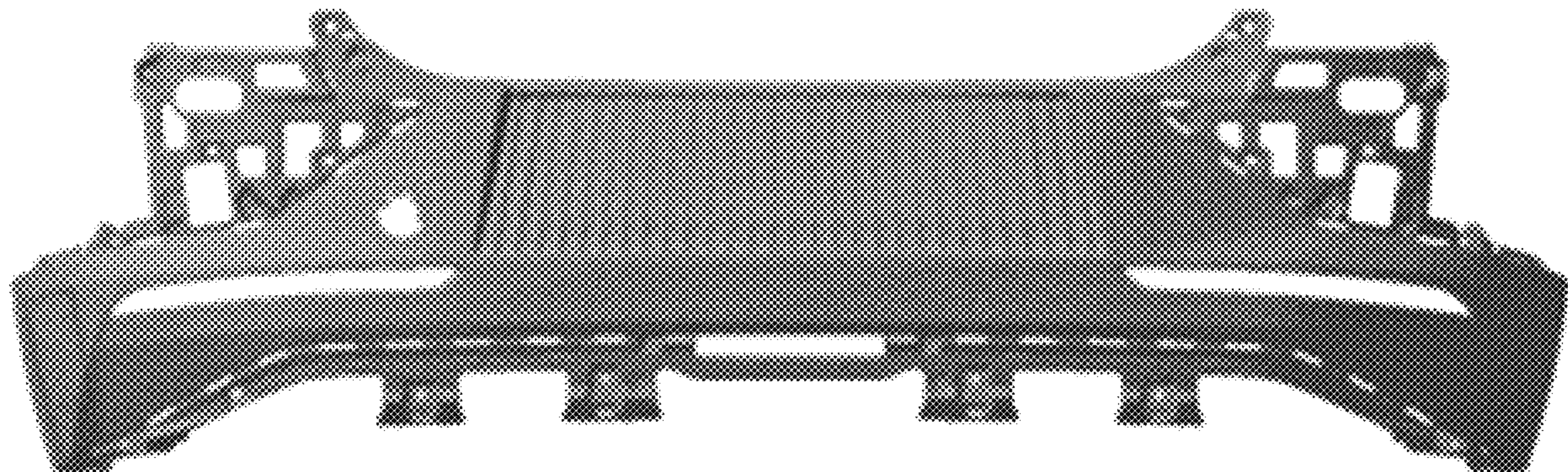

FIG. 1

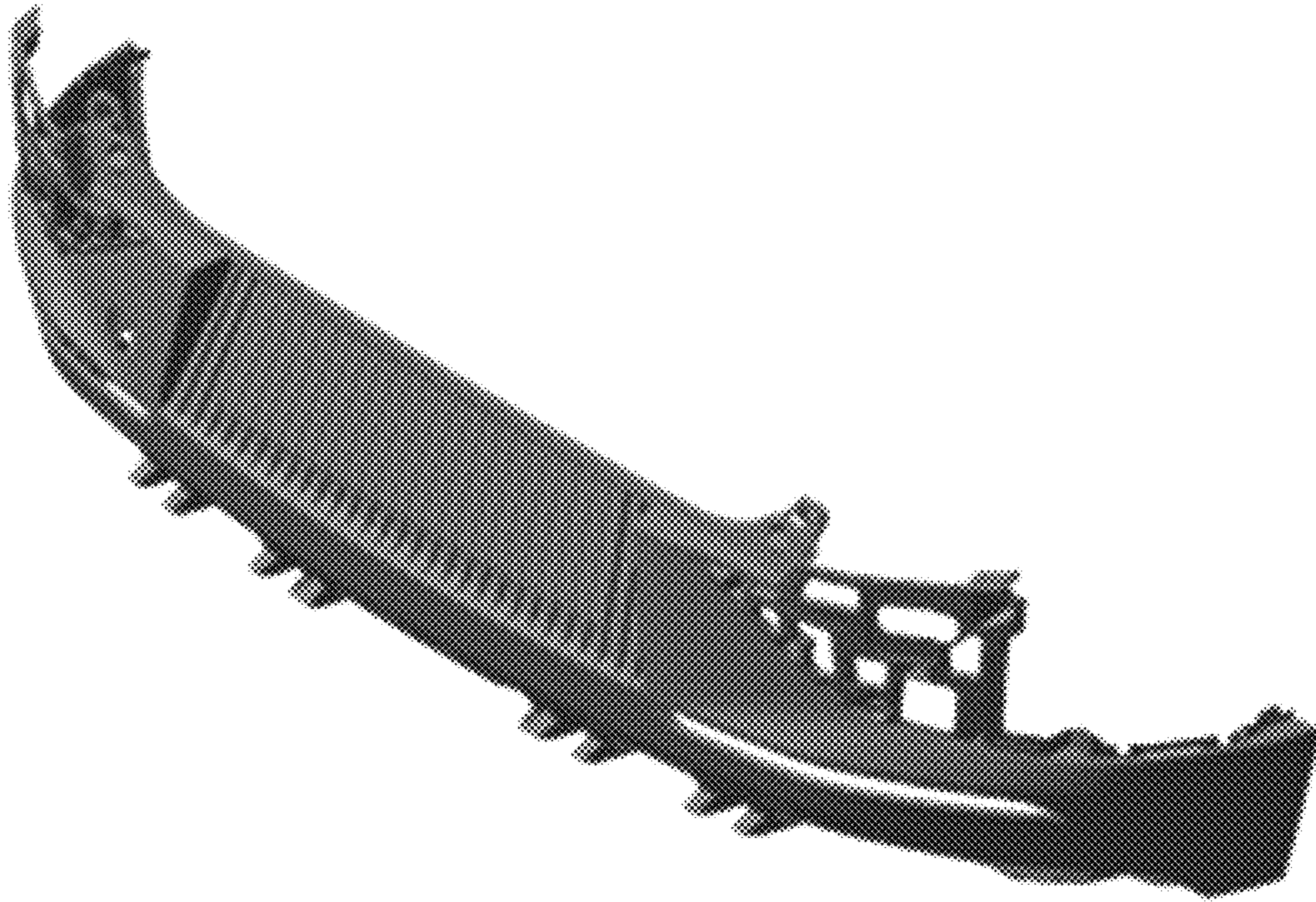

FIG. 2

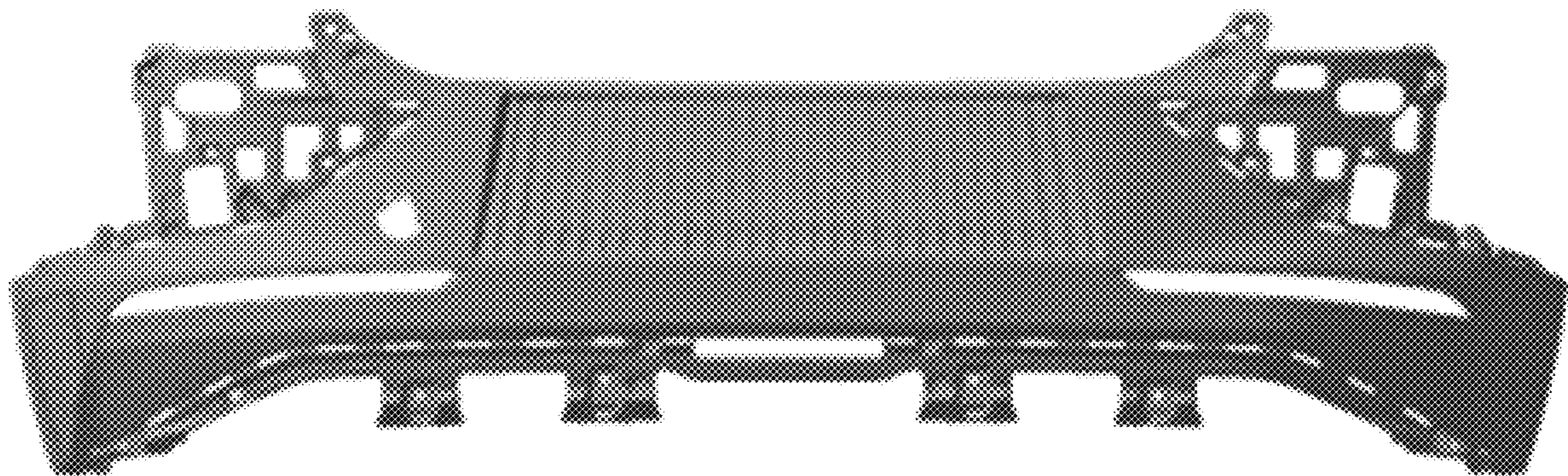

FIG. 3

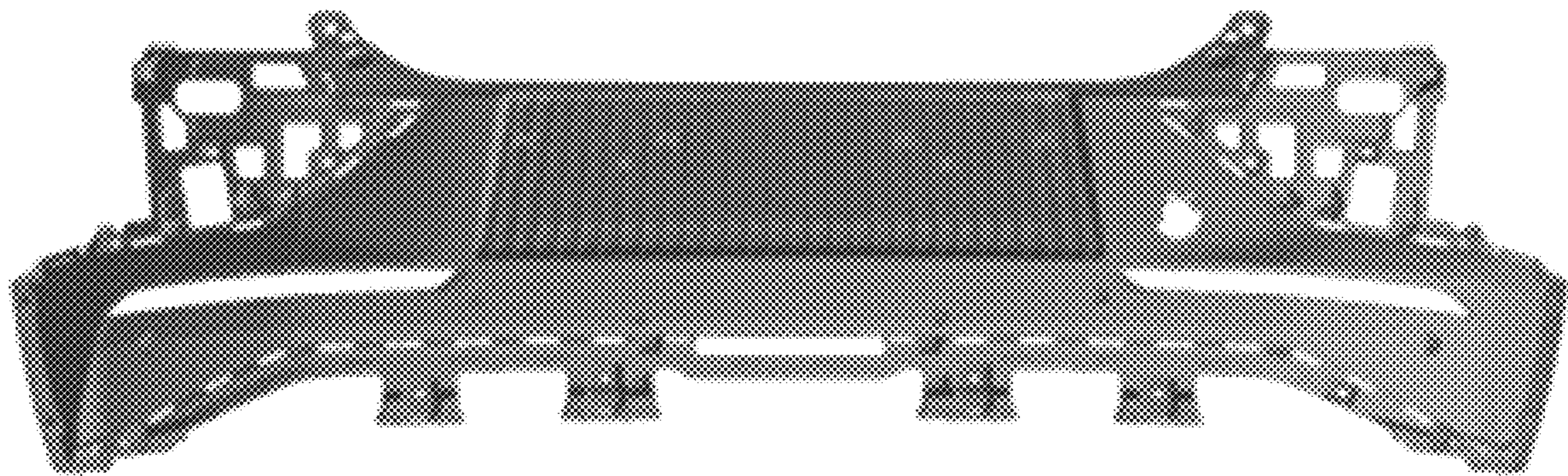

FIG. 4

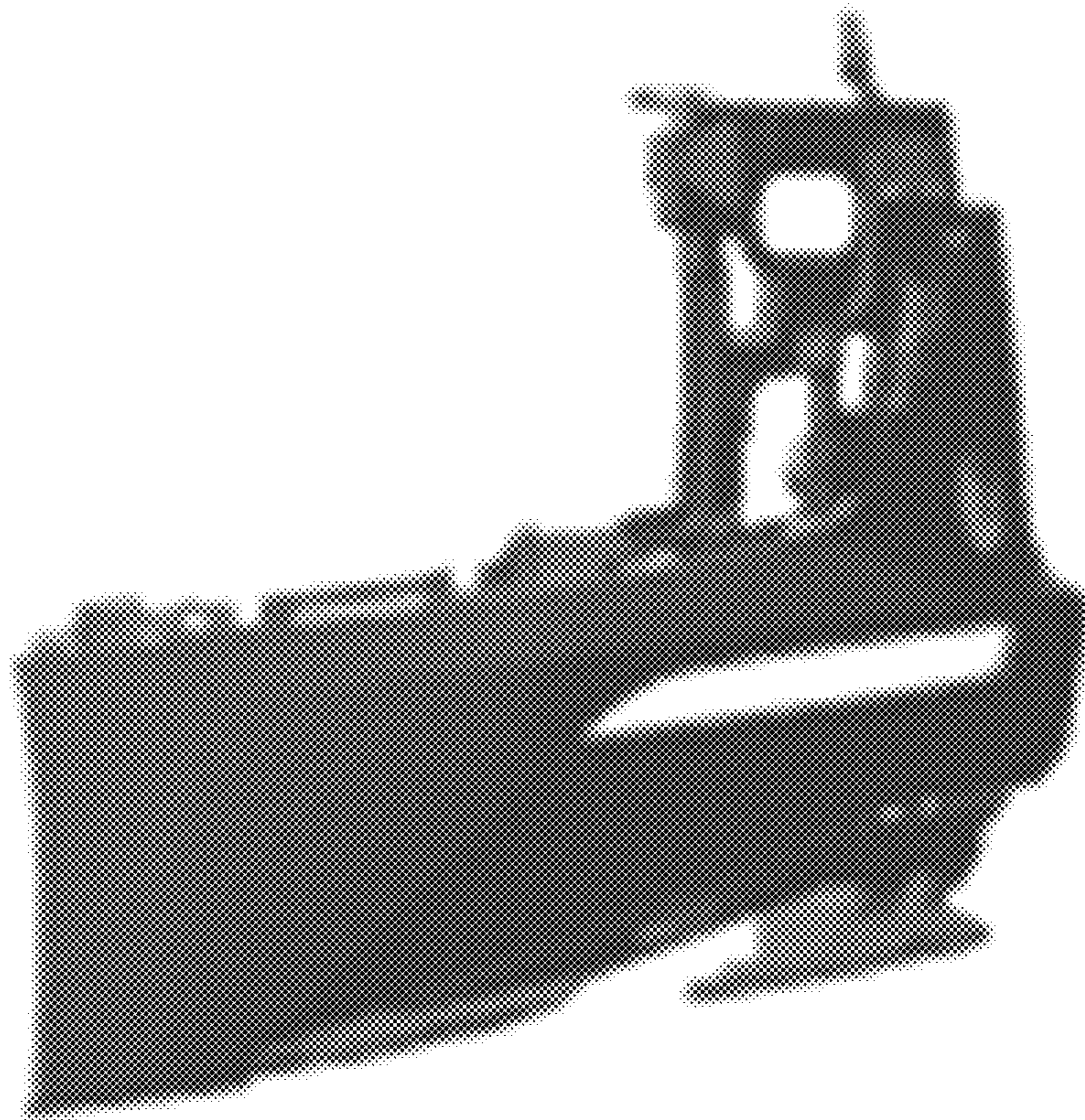

FIG. 5

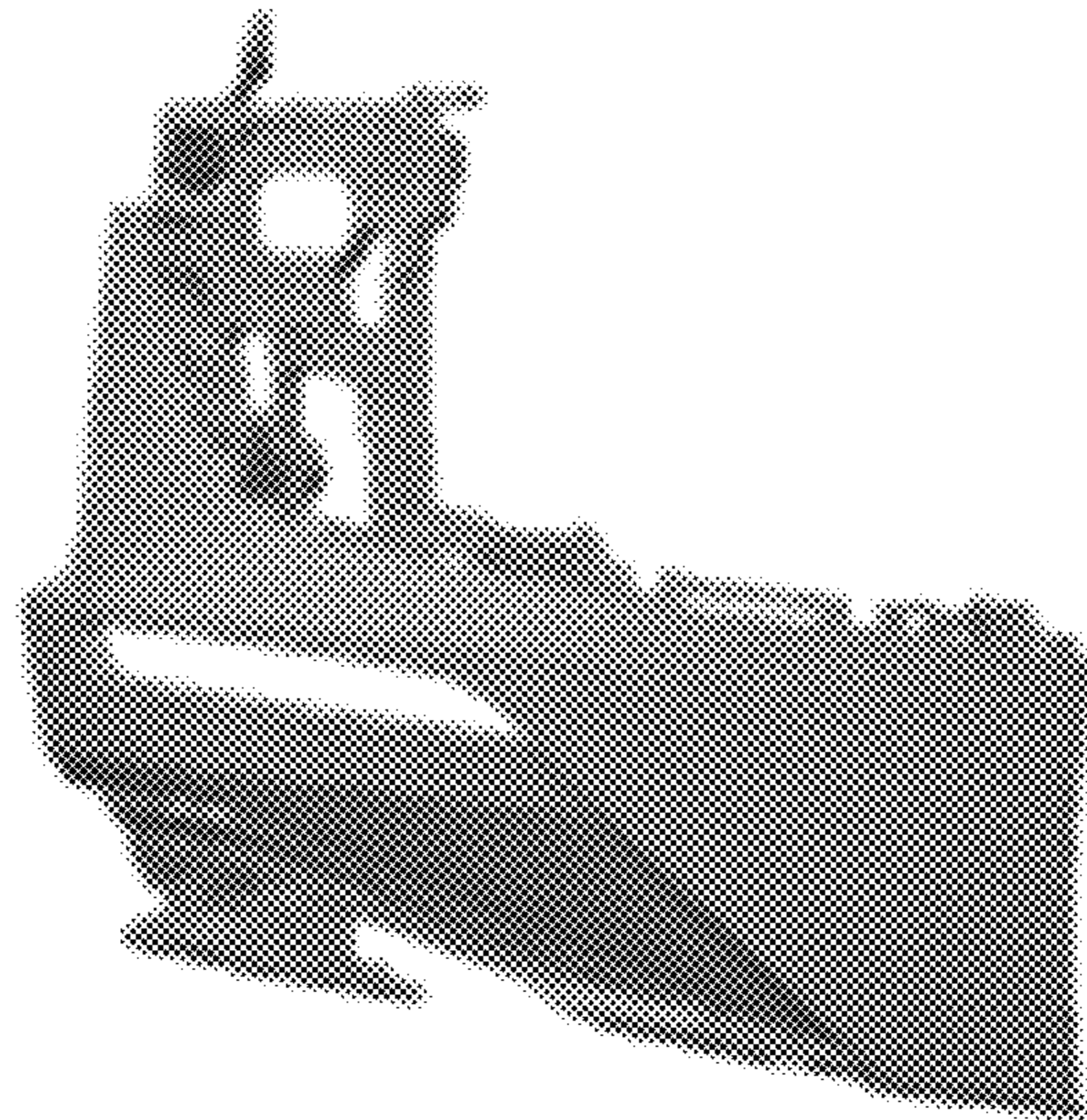

FIG. 6

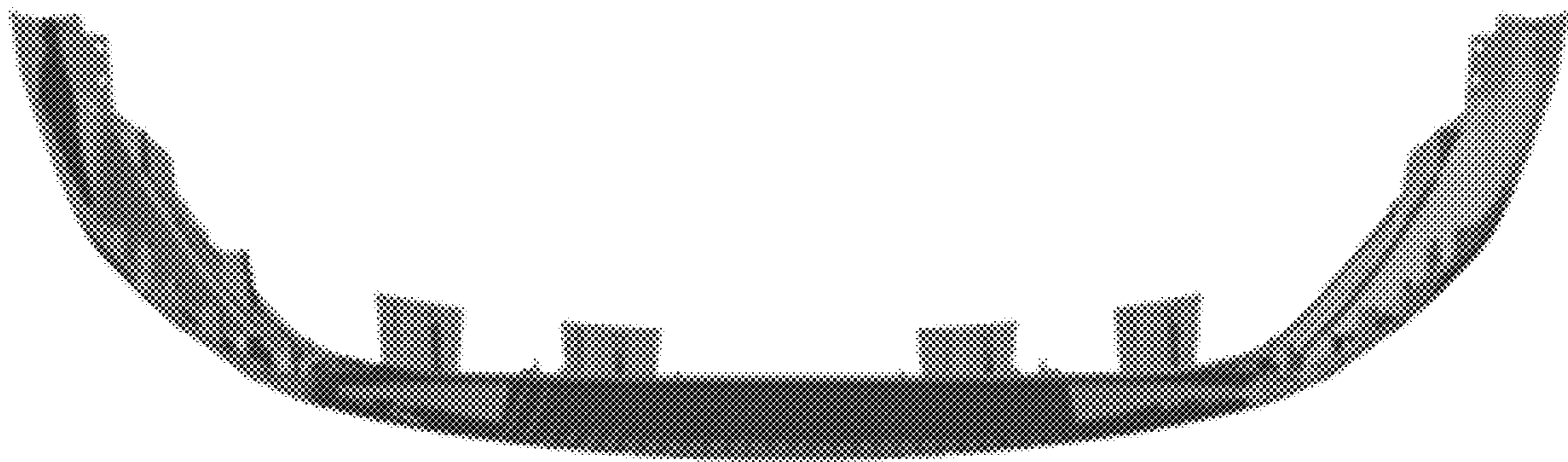

FIG. 7

