



US00D977354S

(12) **United States Design Patent**
Mishina

(10) **Patent No.:** **US D977,354 S**

(45) **Date of Patent:** **** Feb. 7, 2023**

(54) **OPERATING PANEL FOR ELEVATOR**

(71) Applicant: **Mitsubishi Electric Corporation,**
Tokyo (JP)

(72) Inventor: **Kenta Mishina,** Tokyo (JP)

(73) Assignee: **Mitsubishi Electric Corporation,**
Tokyo (JP)

(**) Term: **15 Years**

(21) Appl. No.: **29/753,486**

(22) Filed: **Sep. 30, 2020**

(30) **Foreign Application Priority Data**

Apr. 6, 2020 (JP) 2020-007218 D
Apr. 6, 2020 (JP) 2020-007219 D
Apr. 6, 2020 (JP) 2020-007220 D
Apr. 6, 2020 (JP) 2020-007221 D

(51) **LOC (14) Cl.** **10-05**

(52) **U.S. Cl.**
USPC **D10/108**

(58) **Field of Classification Search**
USPC D10/108, 106.95; D14/307, 491;
D13/164, 174
See application file for complete search history.

(56) **References Cited**

U.S. PATENT DOCUMENTS

D342,683 S * 12/1993 Cohen D13/164
D381,960 S * 8/1997 Chandler D10/49

D512,691 S * 12/2005 Hisatsune D13/164
D589,832 S * 4/2009 Ogura D10/108
D696,602 S * 12/2013 Saikawa D13/164
D699,617 S * 2/2014 Saikawa D13/164
D705,689 S * 5/2014 Saikawa D13/164
D871,948 S * 1/2020 Hikima D10/108

* cited by examiner

Primary Examiner — George D. Kirschbaum

(74) *Attorney, Agent, or Firm* — Studebaker & Brackett
PC

(57) **CLAIM**

The ornamental design for an operating panel for elevator, as shown and described.

DESCRIPTION

FIG. 1 is a perspective view of an operating panel for elevator showing a first embodiment of my new design; FIG. 2 is a front view thereof; FIG. 3 is a rear view thereof; FIG. 4 is a left side view thereof; FIG. 5 is a right side view thereof; FIG. 6 is a top view thereof; FIG. 7 is a bottom view thereof; FIG. 8 is a partially enlarged view taken along line 8-8 of FIG. 1; FIG. 9 is an enlarged cross-sectional view thereof; taken along line 9-9 of FIG. 2, with the internal system omitted; and, FIG. 10 is a reference view showing the state in use.

1 Claim, 10 Drawing Sheets

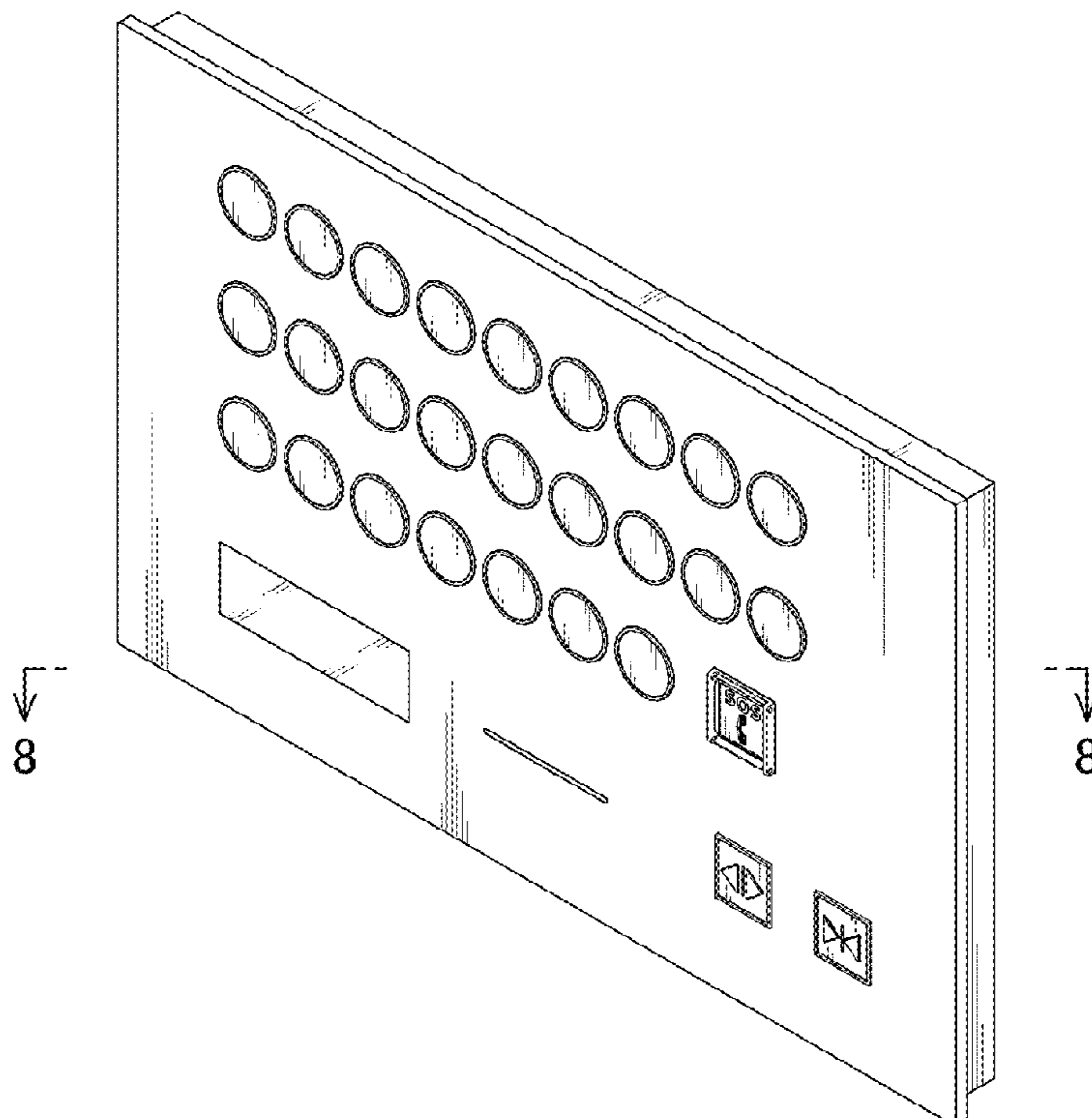

Fig.1

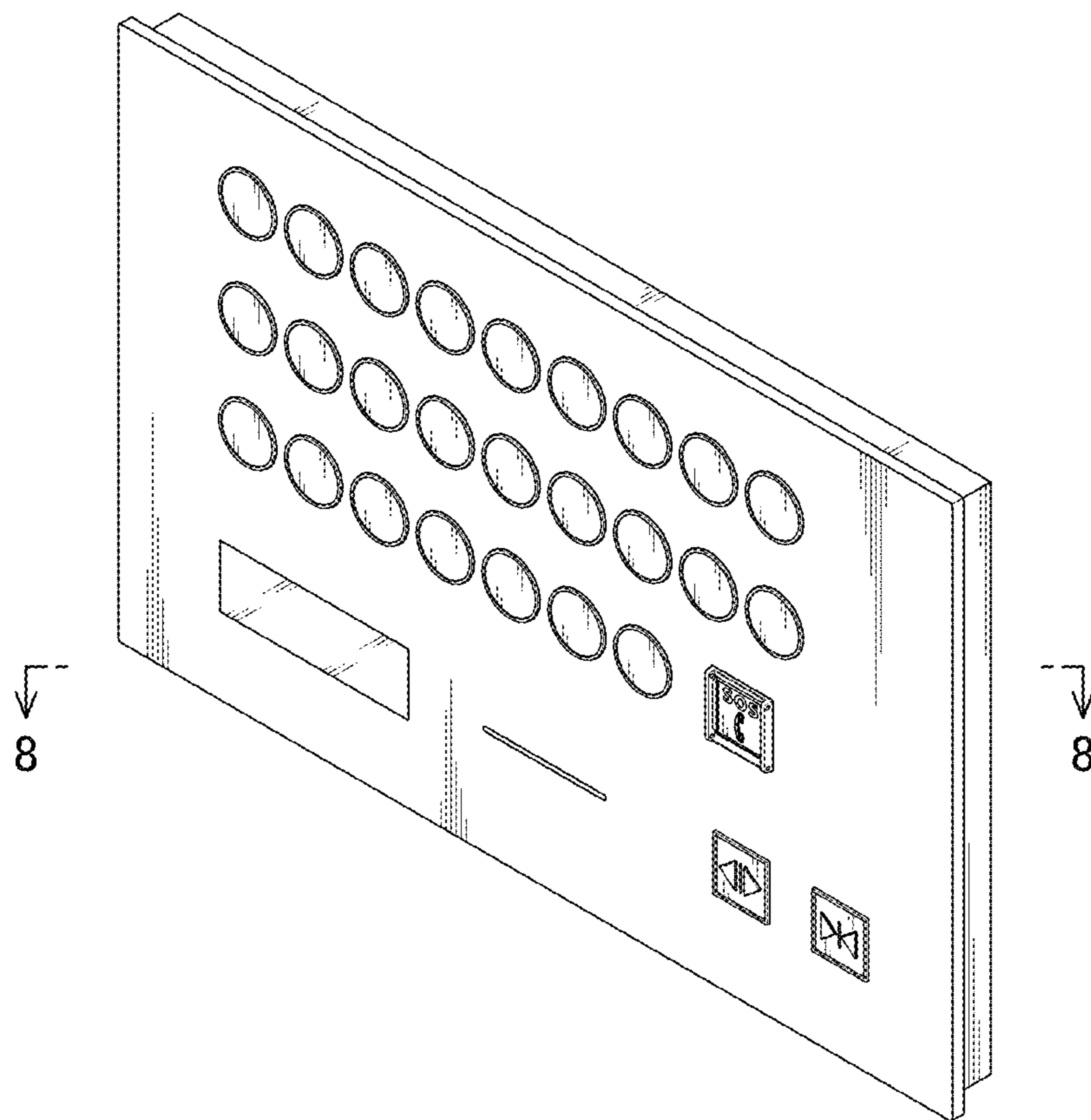

Fig.2

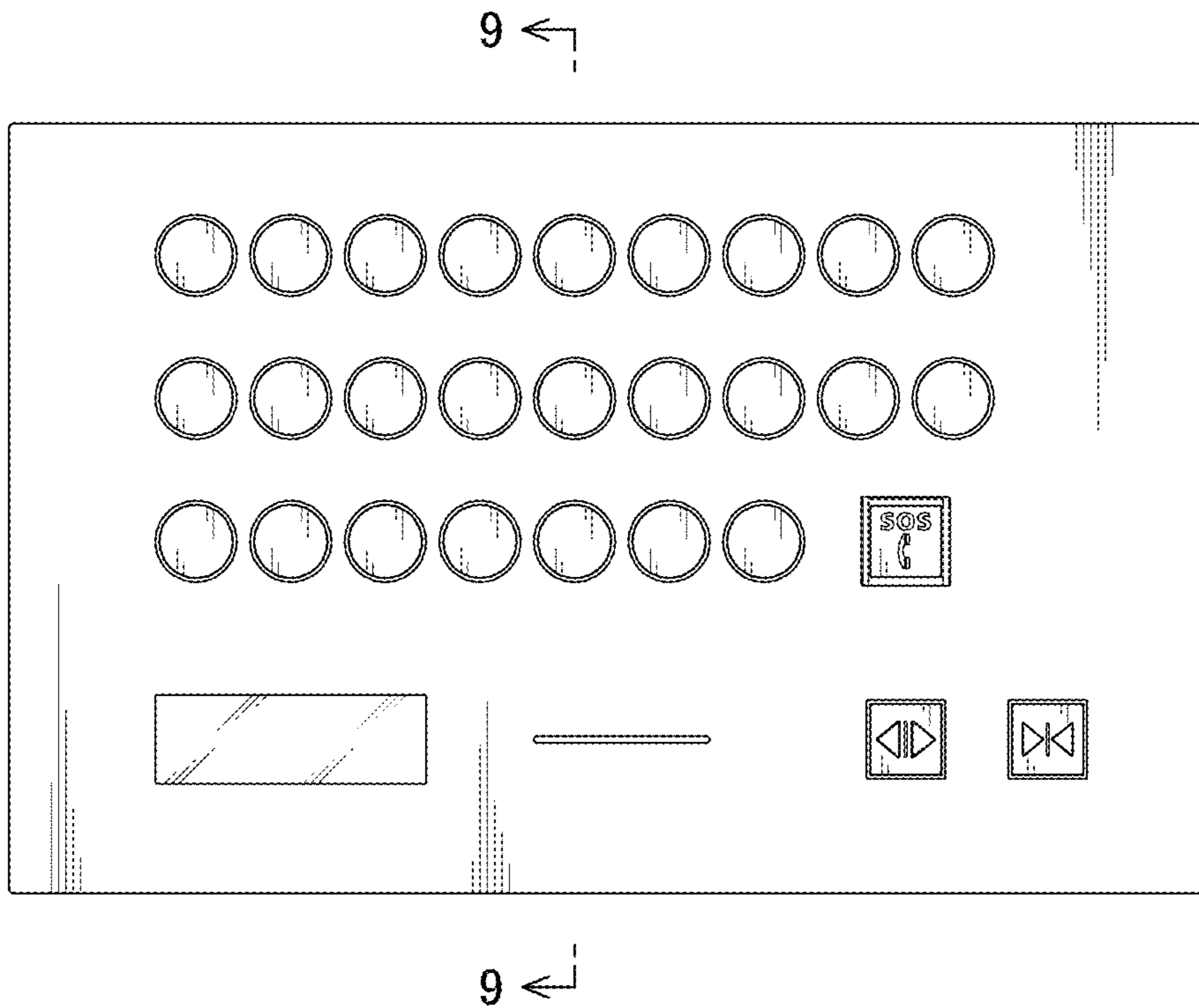

Fig.3

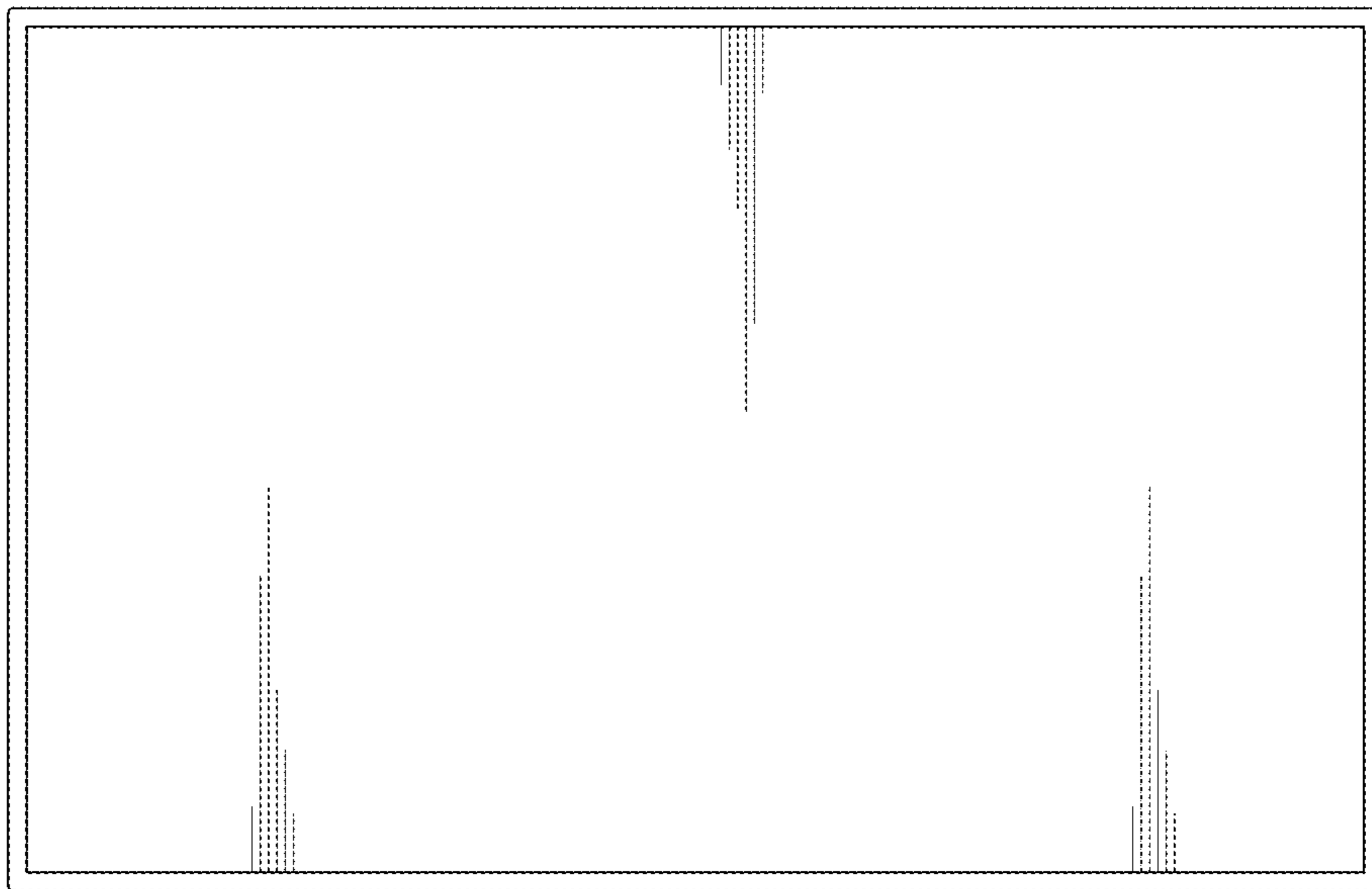

Fig.4

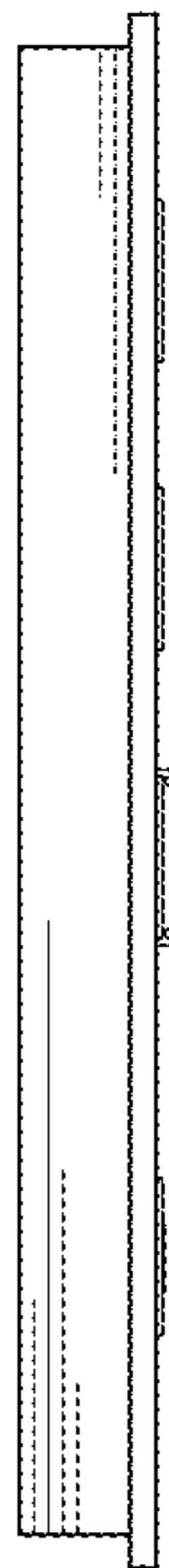

Fig.5

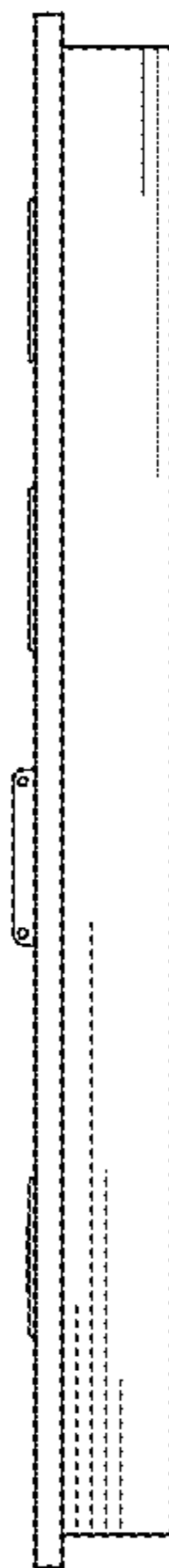

Fig.6

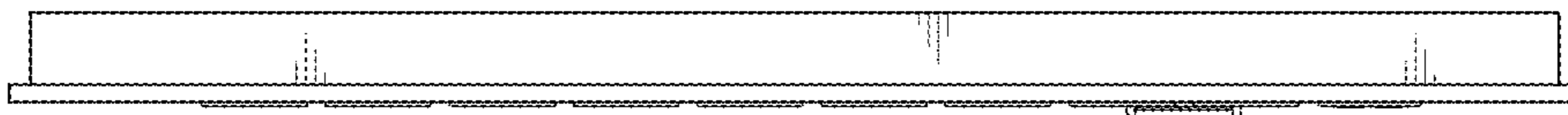

Fig.7

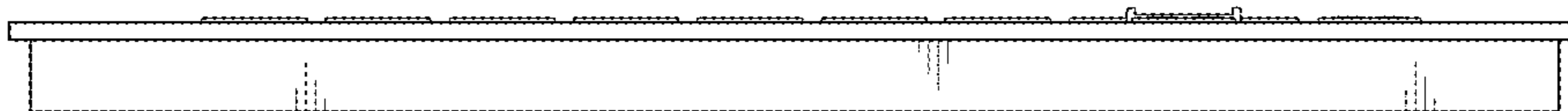

Fig.8

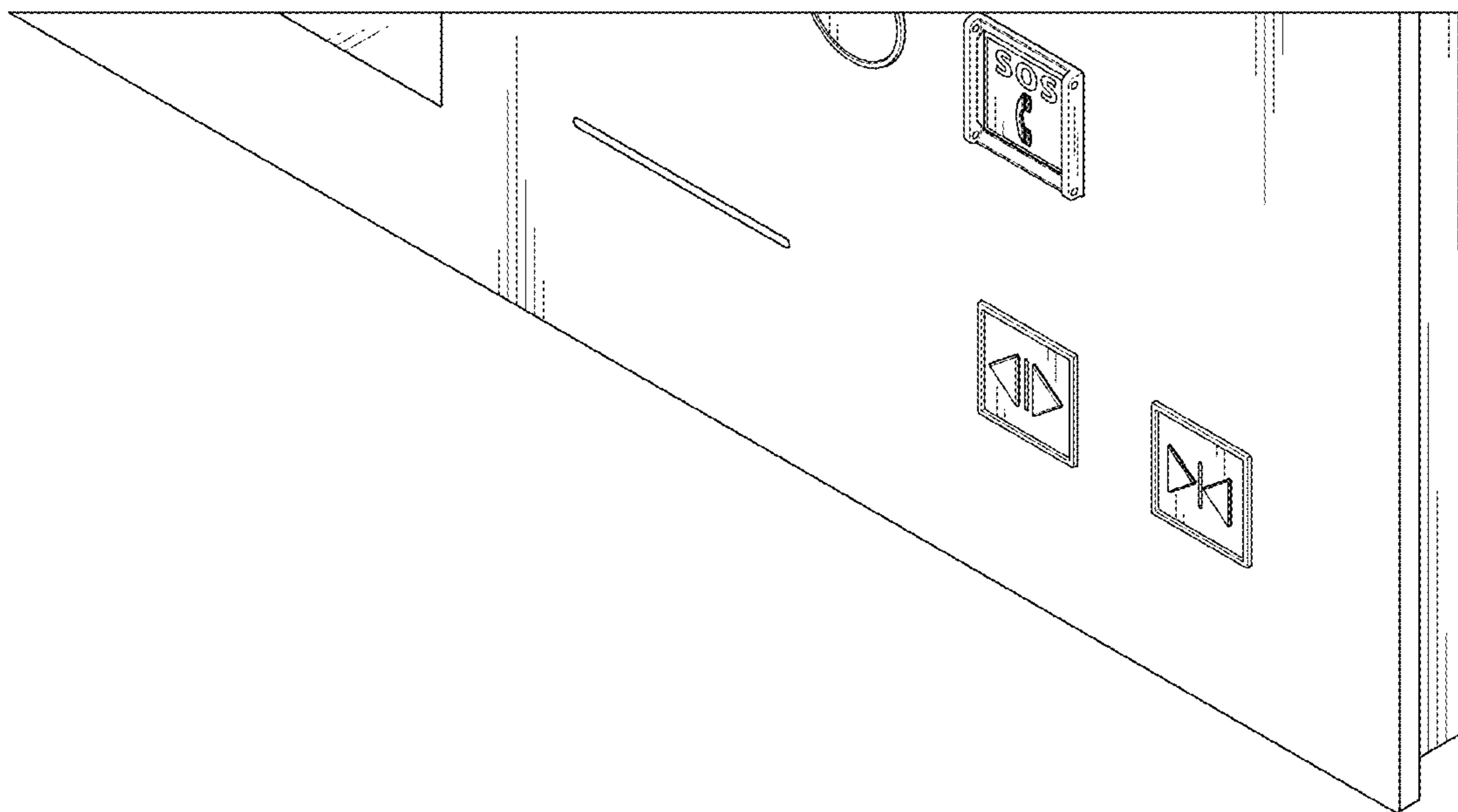

Fig.9

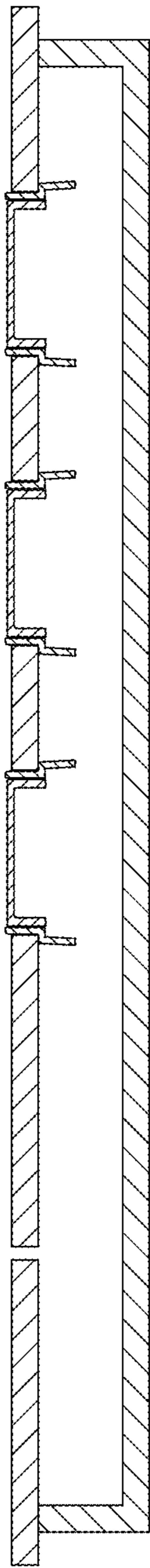

Fig.10

