



US00D977309S

(12) **United States Design Patent** (10) **Patent No.:** **US D977,309 S**
Sorio (45) **Date of Patent:** **** Feb. 7, 2023**

(54) **FLASK**

(71) Applicant: **TOTAL JUGGLING S.R.L.**, Marcon (IT)

(72) Inventor: **Adriano Sorio**, Rapallo (IT)

(73) Assignee: **TOTAL JUGGLING S.R.L.**, Marcon (IT)

(**) Term: **15 Years**

(21) Appl. No.: **35/512,301**

(22) Filed: **Jul. 9, 2021**

(80) **Hague Agreement Data**

Int. Filing Date: **Jul. 9, 2021**
Int. Reg. No.: **DM/215492**
Int. Reg. Date: **Jul. 9, 2021**
Int. Reg. Pub. Date: **Jul. 30, 2021**

(51) **LOC (14) Cl.** **07-10**

(52) **U.S. Cl.**
USPC **D7/608; D7/511**

(58) **Field of Classification Search**
USPC D7/509–511, 542, 602, 605, 619.1, 629;
D9/435, 454, 503, 504, 516, 549, 558,
D9/574, 575, 767, 772
CPC A21B 1/06; A21B 1/50; A47J 27/00; A47J
27/04
See application file for complete search history.

(56) **References Cited**

U.S. PATENT DOCUMENTS

D417,127 S * 11/1999 Steadward D7/608
D453,284 S * 2/2002 O'Connor D7/608
D467,804 S * 12/2002 Restrepo D9/558
D529,338 S * 10/2006 Poulson D7/510
D621,666 S * 8/2010 Wahl D7/608
D632,181 S * 2/2011 Kuzma D9/542
D641,636 S * 7/2011 Wang Treadway D9/551
D699,516 S * 2/2014 Kim D9/503

D752,391 S * 3/2016 Hatherell D7/532
D767,338 S * 9/2016 Jones D7/510
9,505,527 B1 * 11/2016 Campbell A47G 19/2205
D790,920 S * 7/2017 Goodwin D9/503
D795,645 S * 8/2017 Peng D9/503
D808,226 S * 1/2018 Bradley D9/503
D830,784 S * 10/2018 Moore D7/608
D838,172 S * 1/2019 Tartock D9/454
D839,673 S * 2/2019 Meyers D9/503
D850,854 S * 6/2019 Lyons D9/503

(Continued)

OTHER PUBLICATIONS

YouTube—iDrink channel, b-evo Bottle—Evolution by iDrink, Publication date Nov. 4, 2021, [site visited Jul. 11, 2022], Available on the Internet URL <https://www.youtube.com/watch?v=xDBU8kl0H8s> (Year: 2021).*

(Continued)

Primary Examiner — S. Bryan Reinholdt, Jr.
(74) *Attorney, Agent, or Firm* — Saidman DesignLaw Group, LLC

(57) **CLAIM**

The ornamental design for a flask, as shown and described.

DESCRIPTION

- 1. Flask
- 1.1 : Perspective
- 1.2 : Front
- 1.3 : Back
- 1.4 : Left
- 1.5 : Right
- 1.6 : Top
- 1.7 : Bottom
- 1.8 : Exploded
- 1.9 : Back perspective

The broken lines and the areas within them in FIG. 1.7 depict portions of the flask which form no part of the claimed design.

1 Claim, 9 Drawing Sheets

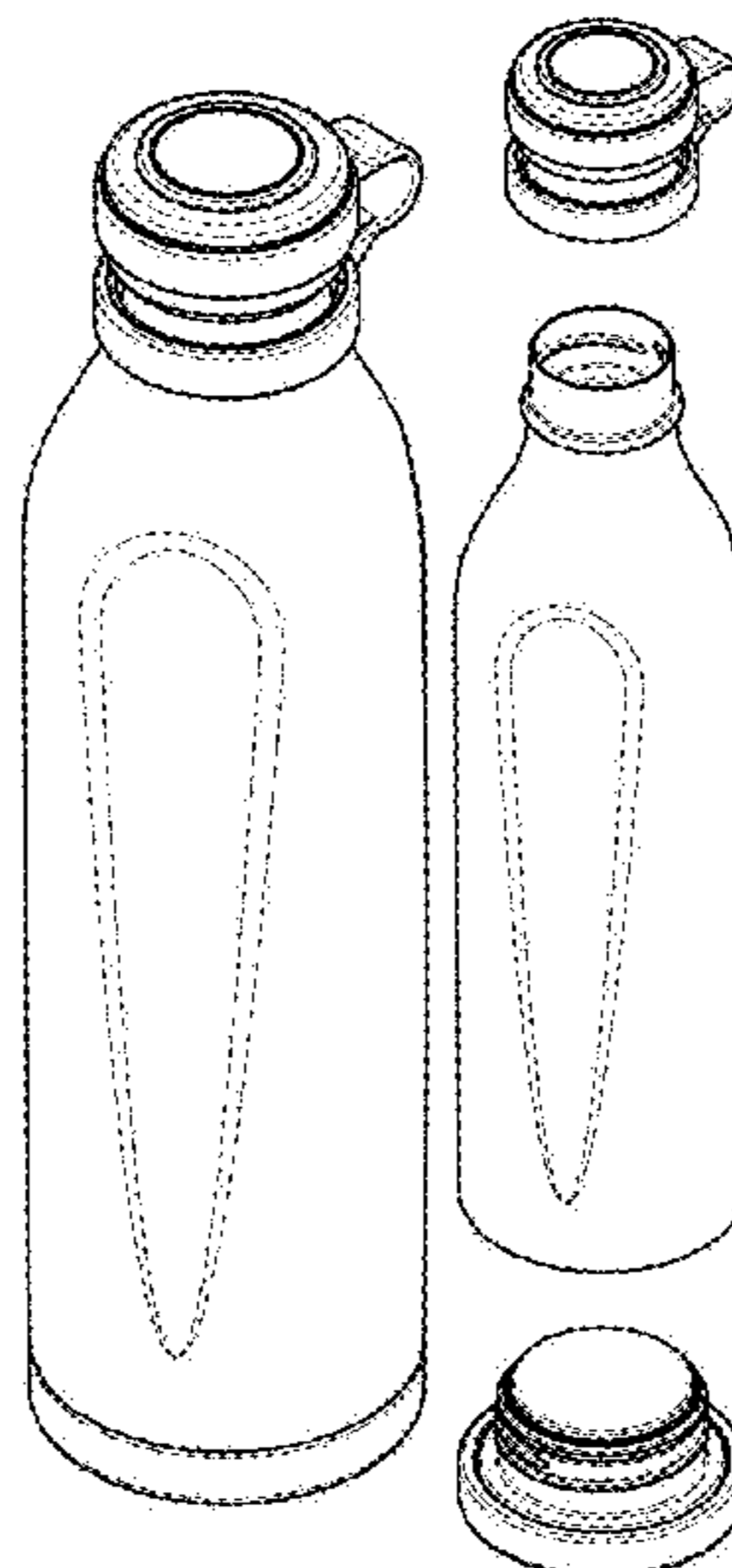

(56)

References Cited

U.S. PATENT DOCUMENTS

D852,001 S * 6/2019 Campbell D7/510
D856,081 S * 8/2019 Rogers D9/503
D856,082 S * 8/2019 Yao D7/532
D858,212 S * 9/2019 Hewitt D7/510
D861,430 S * 10/2019 Yueh D7/532
D862,992 S * 10/2019 Wong D7/608
D867,519 S * 11/2019 Furgurson D9/503
D871,840 S * 1/2020 Meyers D9/503
D871,855 S * 1/2020 Fleischhut D9/503
D872,535 S * 1/2020 Eyal D7/510
D878,863 S * 3/2020 Ke D7/532
D885,836 S * 6/2020 Wang D9/504
D899,872 S * 10/2020 Hurme D7/608
D917,231 S * 4/2021 Wang D9/504
D944,056 S * 2/2022 Papparao D7/509
2018/0353011 A1 * 12/2018 Pinelli A47J 41/028
2019/0246822 A1 * 8/2019 Horwitz A47G 19/2205
2021/0036528 A1 * 2/2021 Casale H02J 7/0063

OTHER PUBLICATIONS

I-drink website, On-the-go, Publication date unknown, [site visited Jul. 11, 2022], Available on the Internet URL <https://i-drinkbottles.com/on-the-go/> (Year: 2022).*

* cited by examiner

1.1

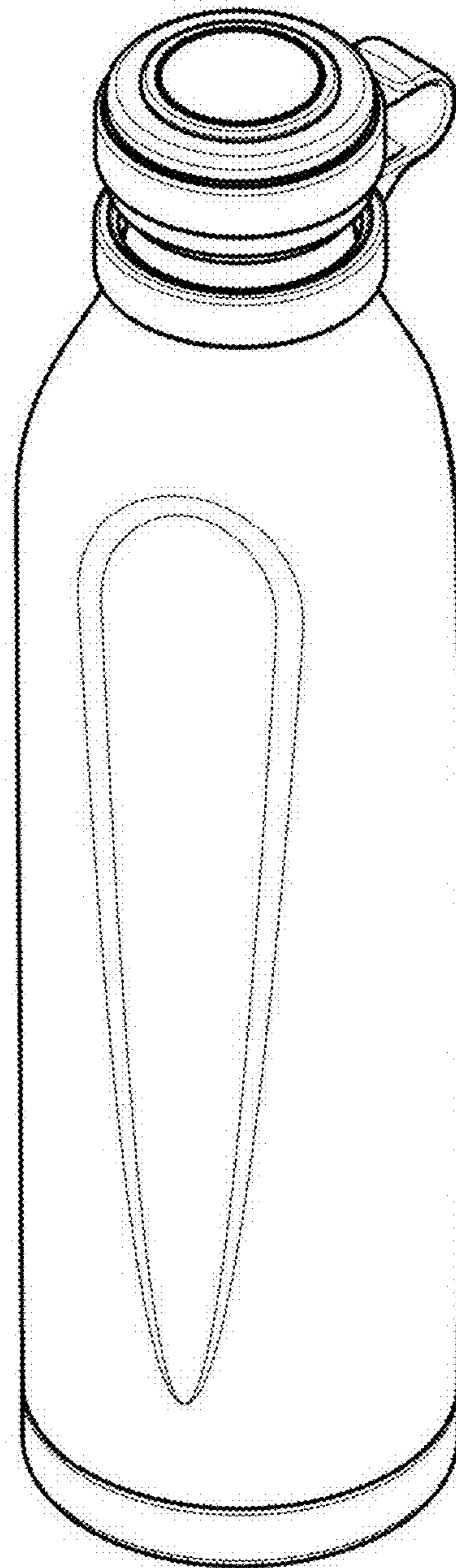

1.2

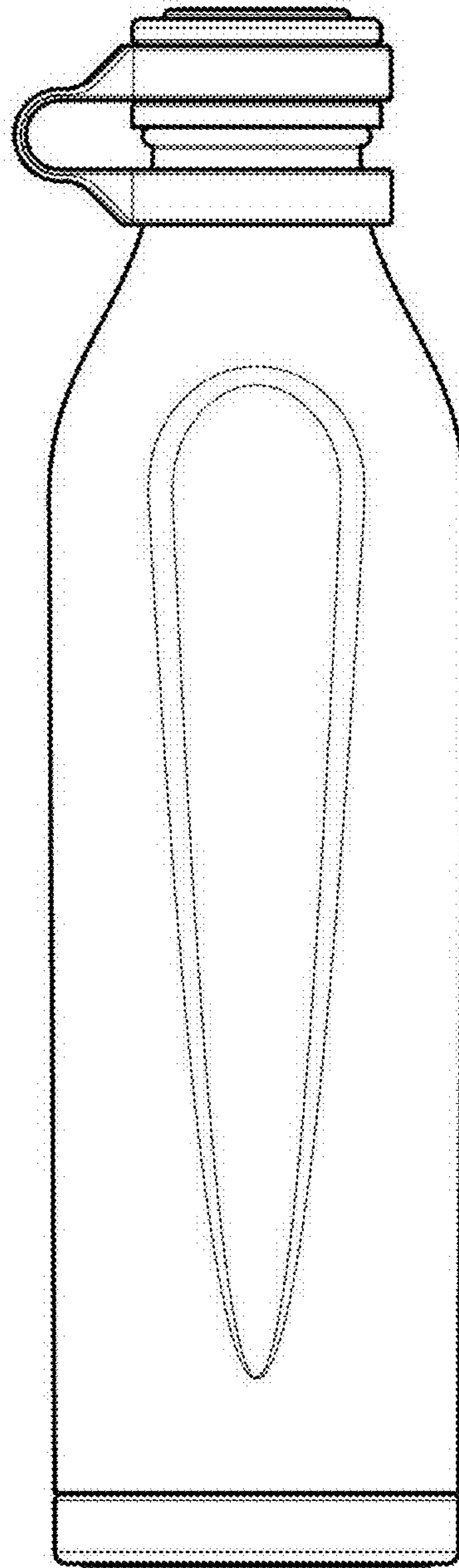

1.3

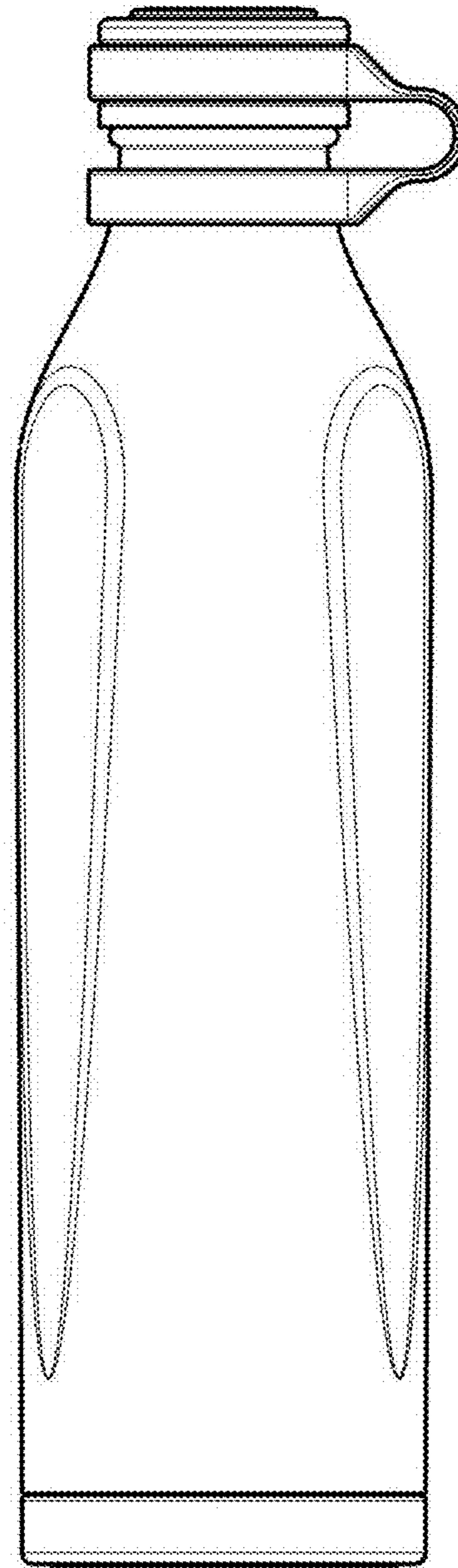

1.4

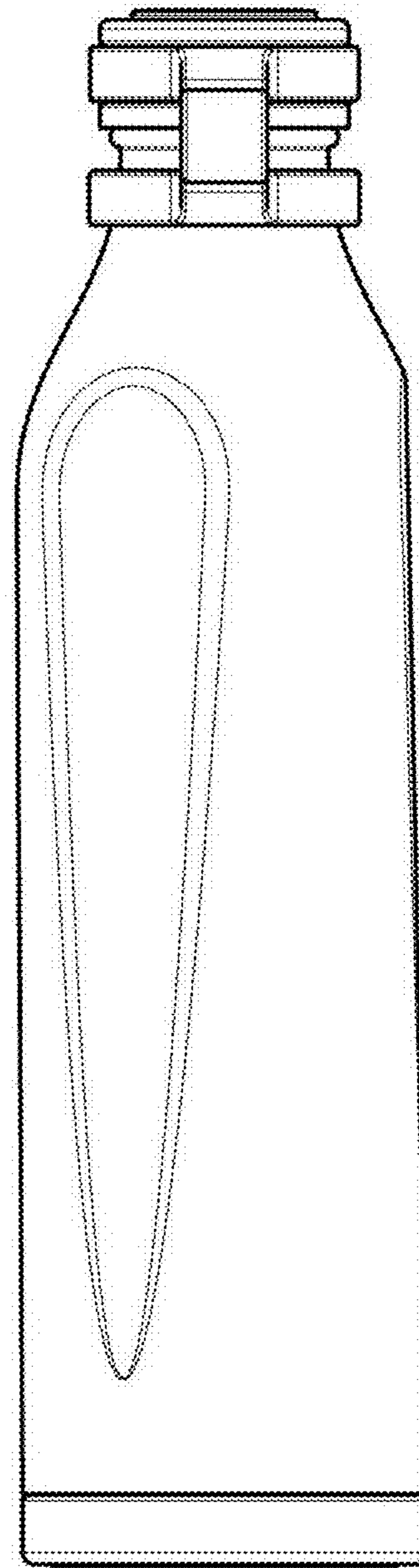

1.5

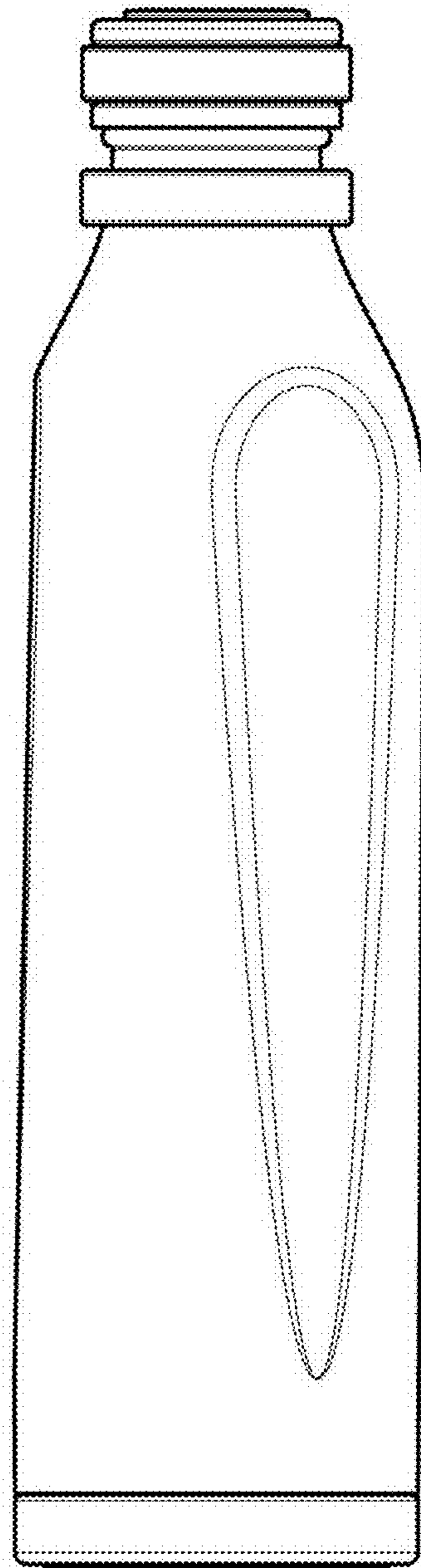

1.6

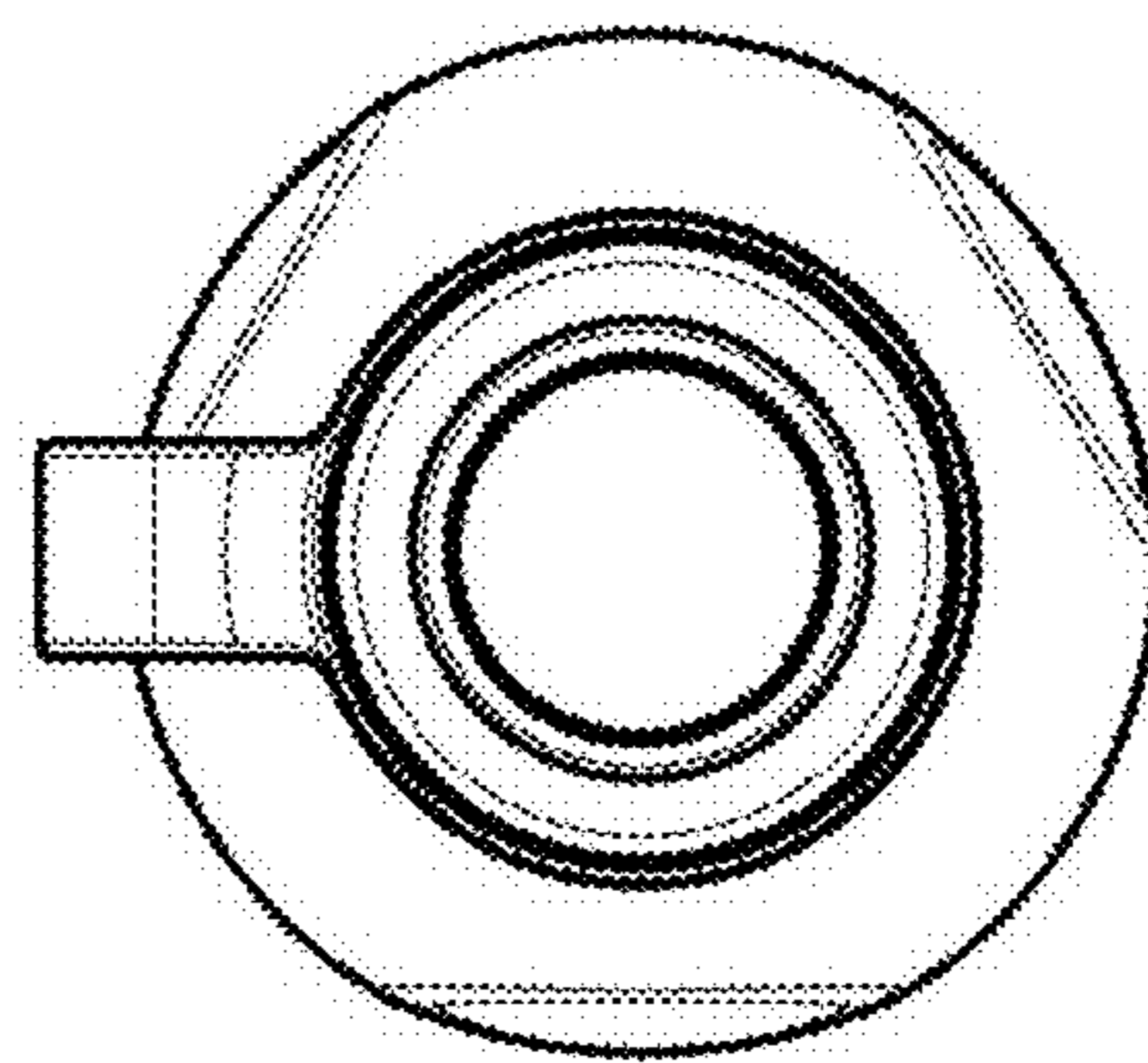

1.7

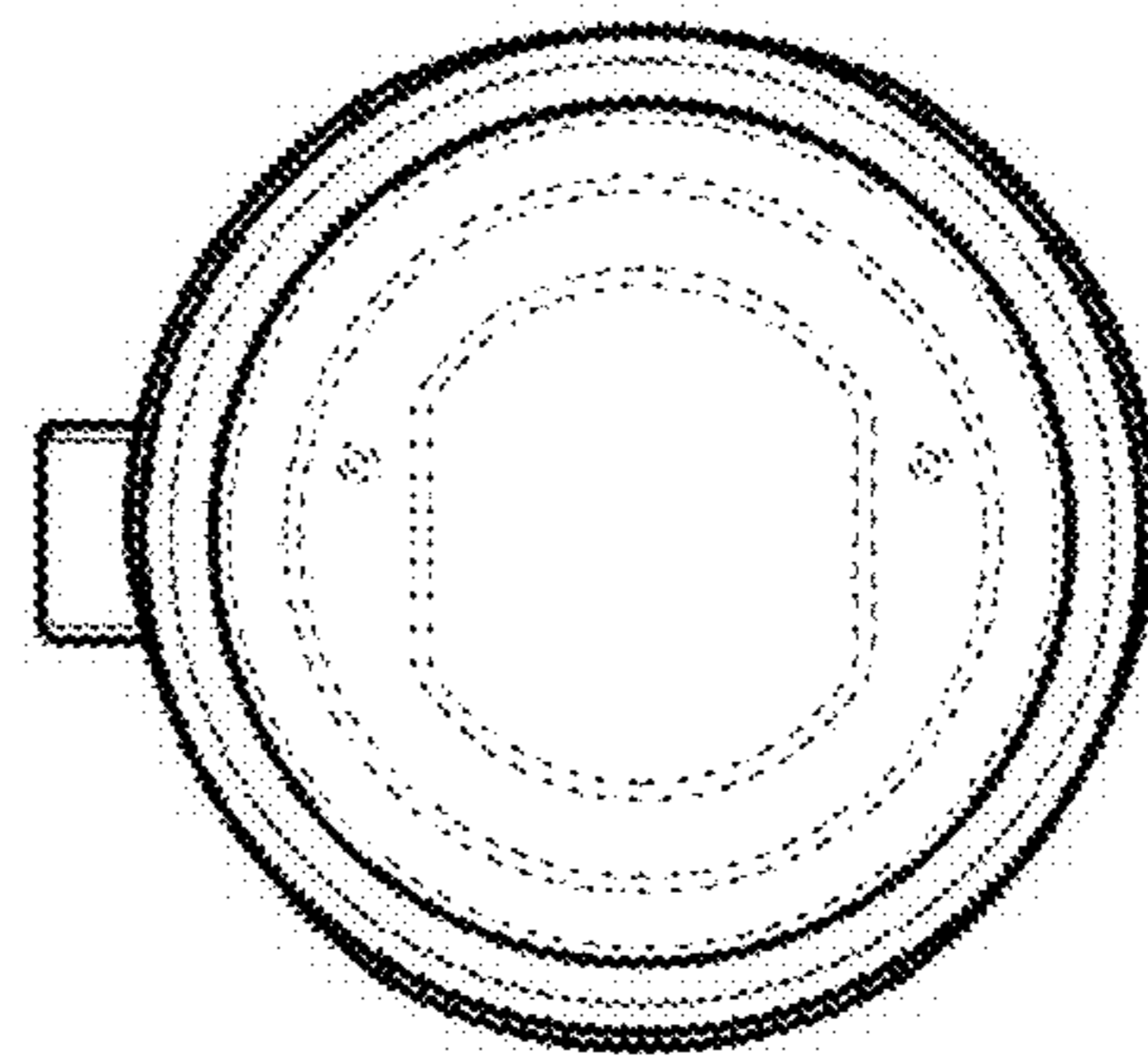

1.8

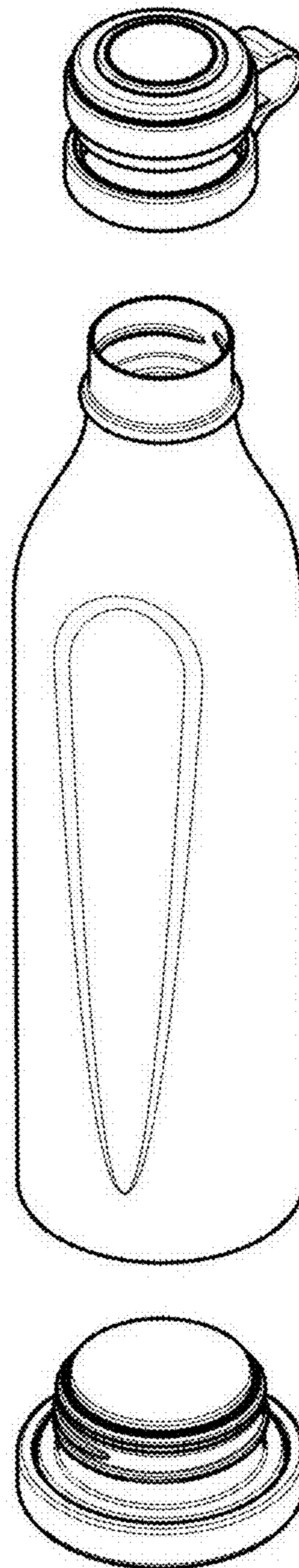

1.9

