



US00D977255S

(12) **United States Design Patent** (10) **Patent No.:** **US D977,255 S**
Hu (45) **Date of Patent:** **** Feb. 7, 2023**

(54) **BLADE STORAGE DEVICE**
(71) Applicant: **Pangying Hu**, Nileke (CN)
(72) Inventor: **Pangying Hu**, Nileke (CN)
(**) Term: **15 Years**
(21) Appl. No.: **29/853,712**
(22) Filed: **Sep. 19, 2022**
(51) **LOC (14) Cl.** **03-01**
(52) **U.S. Cl.**
USPC **D3/319; D8/71**
(58) **Field of Classification Search**
USPC D8/71; D9/415; D3/319, 315
CPC B25H 3/02; B25H 3/021; B25H 3/003;
B65D 85/20
See application file for complete search history.

D651,883 S * 1/2012 Huang D3/315
D652,280 S * 1/2012 Huang B25H 3/003
206/480
8,196,742 B1 * 6/2012 Wang B25H 3/003
206/45.23
D721,891 S 2/2015 Ben-Gigi
D789,086 S 6/2017 Lin
9,694,489 B2 * 7/2017 Steele B25H 3/003
206/349
D822,414 S 7/2018 Palmer
D838,487 S 1/2019 Lai
D838,987 S 1/2019 Lai
D844,986 S 4/2019 Zhao

(Continued)

OTHER PUBLICATIONS

Duryeo, Duryeo Blade Storage Insert for Cricut Maker 3 & Maker, Blades Tray, Drawer Blade Housing and Quickswap Tip Accessories Organizer (Blue,Blades and Housing not Included), amazon.com, Jul. 25, 2022, https://www.amazon.com/Duryeo-Quickswap-Accessories-Organizer-Included/dp/B0B6G7DM8B/ref=sr_1_3?keywords=cricut+blades+storage&qid=1662621198&sr=8-3 (Last accessed: Sep. 19, 2022).

Primary Examiner — Philip S Hyder
(74) *Attorney, Agent, or Firm* — Rमित Ranjit Kanakia

(56) **References Cited**

U.S. PATENT DOCUMENTS

4,619,364 A * 10/1986 Czopor, Jr. B25H 3/003
206/480
5,114,007 A * 5/1992 Chen B25H 3/028
312/902
D343,063 S * 1/1994 Chen D3/905
D358,257 S * 5/1995 Sidabras D3/282
5,525,314 A * 6/1996 Hurson A61B 50/33
206/379
5,570,784 A * 11/1996 Sidabras B25H 3/003
206/378
D392,463 S * 3/1998 Grey D3/319
D395,166 S * 6/1998 Grey D3/319
5,826,719 A * 10/1998 Chen B25H 3/028
312/902
D400,709 S * 11/1998 Chang D3/315
D446,018 S * 8/2001 Streich D3/319
D487,194 S * 3/2004 Liu D3/319
6,820,742 B1 * 11/2004 Chen B65D 43/164
206/378
7,080,733 B2 * 7/2006 Kao B25H 3/04
D3/905

(57) **CLAIM**

The ornamental design for a blade storage device, as shown and described.

DESCRIPTION

FIG. 1 is a front perspective view of a blade storage device showing my new design;
FIG. 2 is a front view thereof;
FIG. 3 is a rear view thereof;
FIG. 4 is a right side view thereof;
FIG. 5 is a left side view thereof;
FIG. 6 is a top view thereof; and,
FIG. 7 is a bottom view thereof.

1 Claim, 5 Drawing Sheets

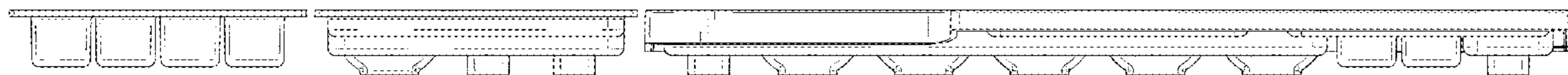

(56)

References Cited

U.S. PATENT DOCUMENTS

10,449,665	B2 *	10/2019	Ernst	B25H 3/003
D896,052	S *	9/2020	Hyma	B25H 3/003
				206/45.23
D945,847	S *	3/2022	Chen	B65D 43/164
				206/378
2005/0211587	A1 *	9/2005	Chen	B25H 3/003
				206/349
2006/0219588	A1 *	10/2006	Chen	B25H 3/003
				206/488
2014/0023475	A1 *	1/2014	Meyers	B25J 1/00
				414/800
2020/0324399	A1 *	10/2020	Christen	B25H 3/003

* cited by examiner

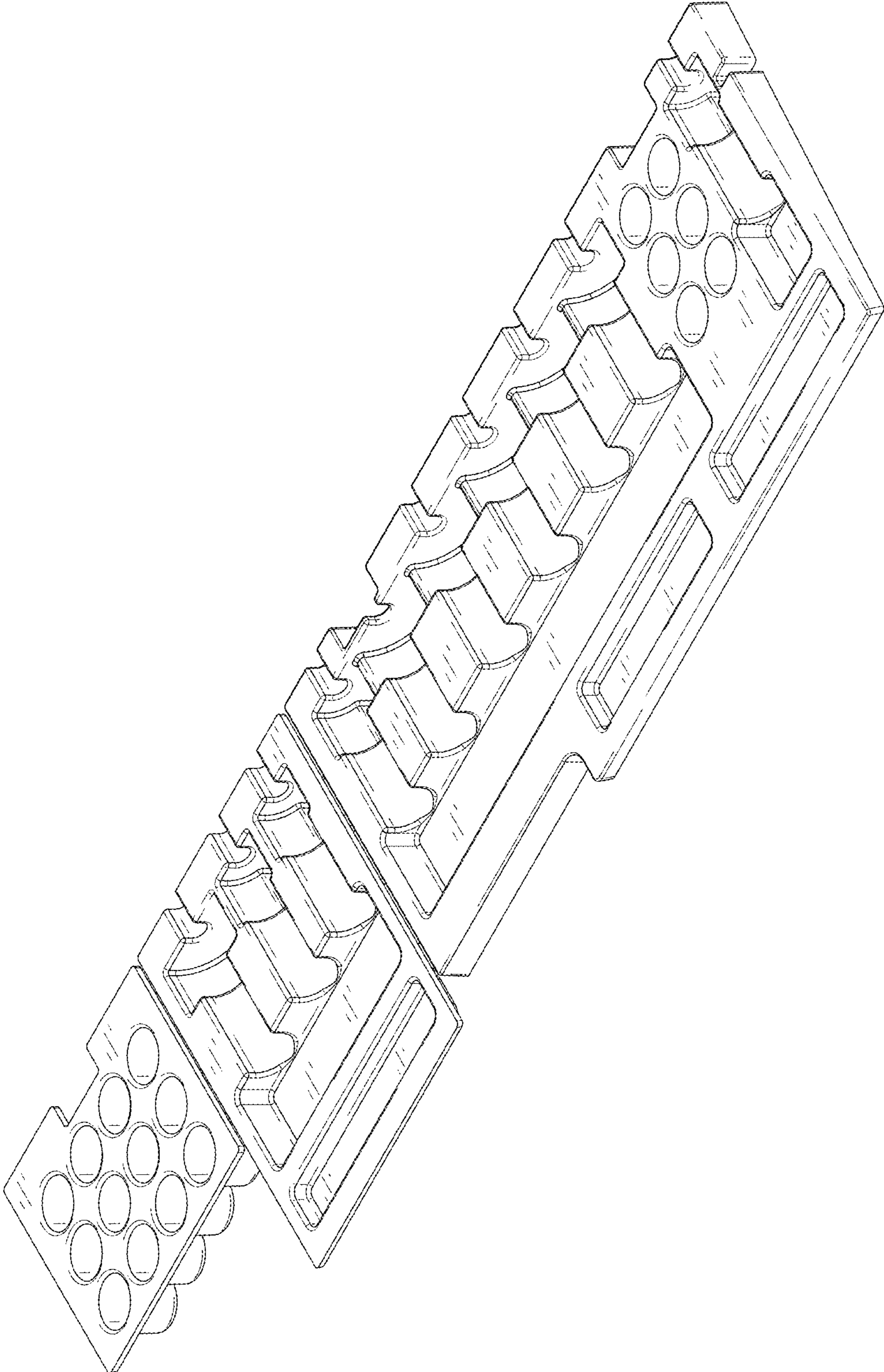

FIG. 1

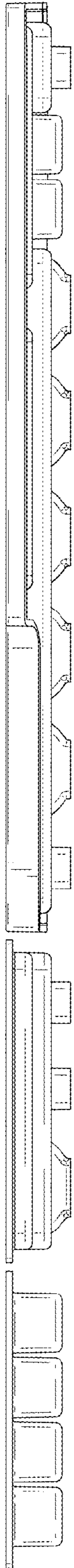

FIG. 2

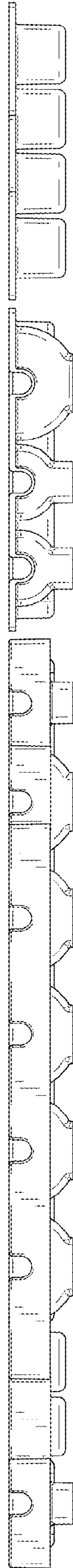

FIG. 3

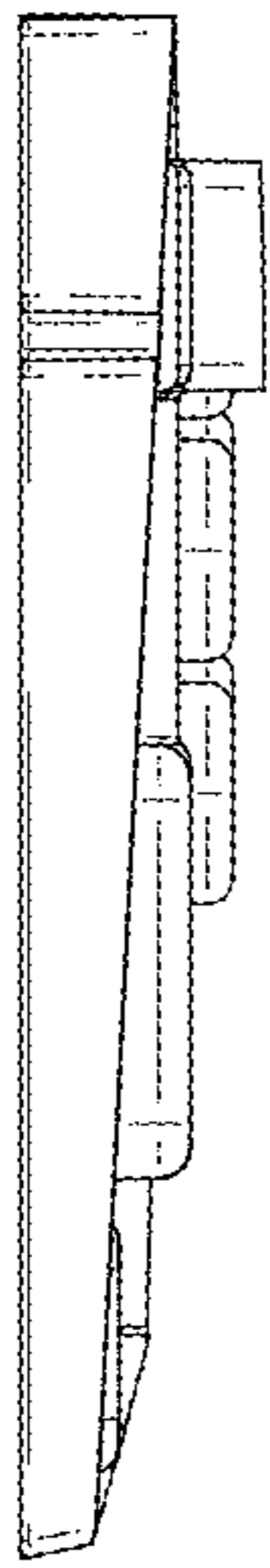

FIG. 4

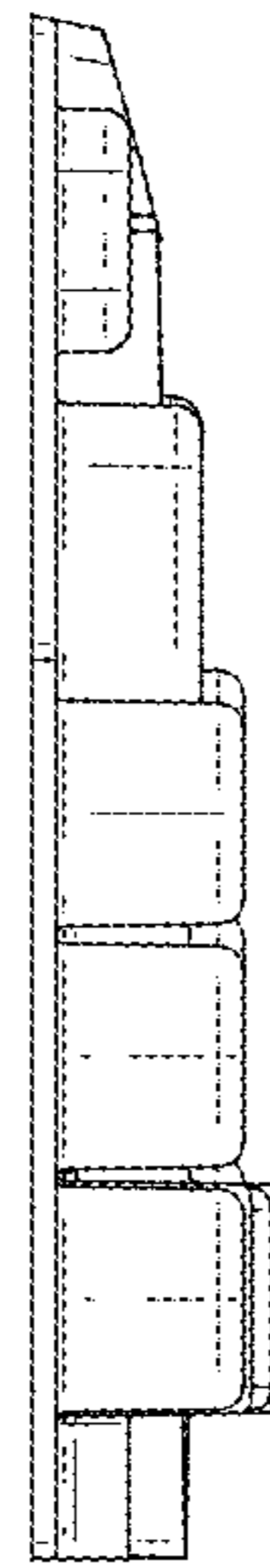

FIG. 5

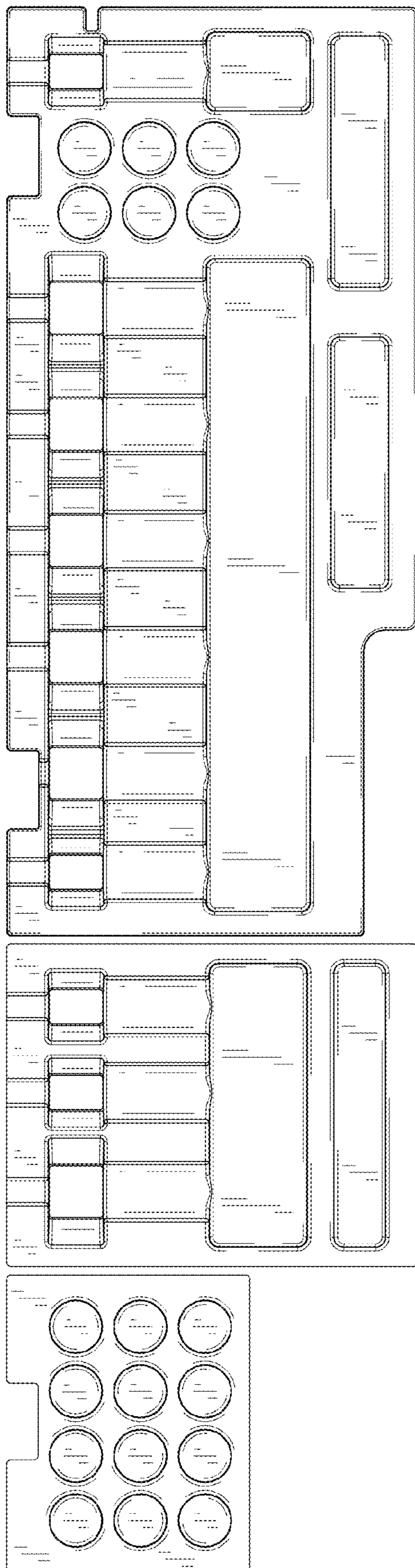

FIG. 6

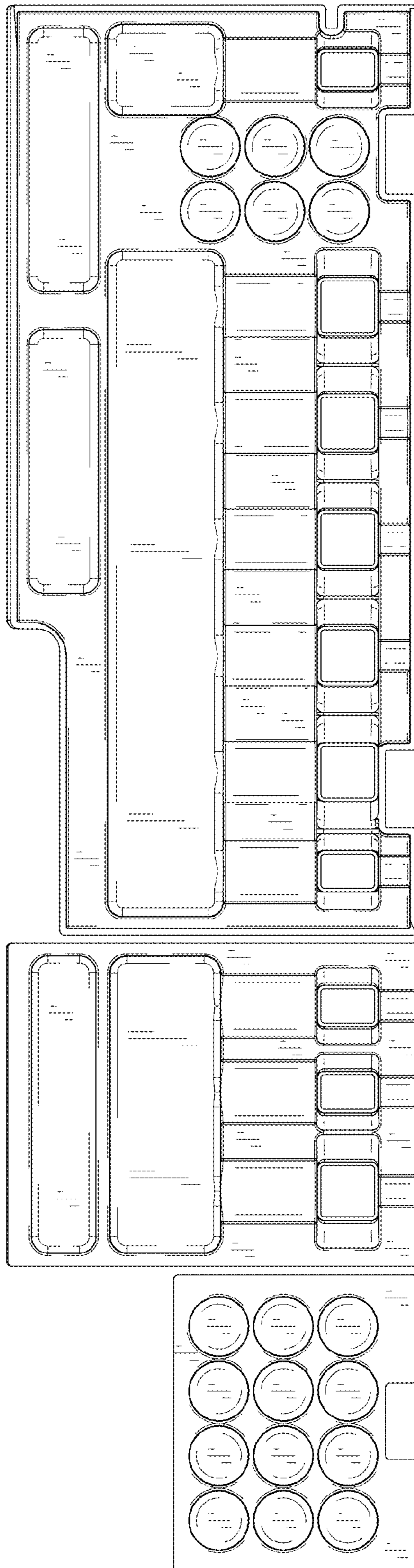

FIG. 7