



US00D977238S

(12) **United States Design Patent** (10) **Patent No.:** **US D977,238 S**
Johnson (45) **Date of Patent:** **** Feb. 7, 2023**

(54) **SHOE STRAP EXTENSION**
(71) Applicant: **Donna Johnson**, Baton Rouge, LA
(US)

D393,337 S * 4/1998 Seki D2/624
D418,273 S * 1/2000 Fulsom D2/602
D473,034 S * 4/2003 Styne A44C 5/0069
D2/624

(Continued)

(72) Inventor: **Donna Johnson**, Baton Rouge, LA
(US)

FOREIGN PATENT DOCUMENTS

(**) Term: **15 Years**

CN 305050410 * 3/2019
WO D060364-014 * 7/2002

(Continued)

(21) Appl. No.: **29/726,421**

OTHER PUBLICATIONS

(22) Filed: **Mar. 3, 2020**

Clan Tartan, Kilt Strap Buckle Extender, (Oct. 17, 2013), Amazon.com, [site visited: Jun. 9, 2022], Available from URL: <https://www.amazon.com/Kilt-Strap-Buckle-Extender-Inch/dp/B00FZ3QHSQ> (Year: 2013).*

(51) **LOC (14) Cl.** **02-07**

(52) **U.S. Cl.**
USPC **D2/978**

(Continued)

(58) **Field of Classification Search**
USPC D2/547, 624, 627, 631, 639, 864, 896,
D2/910, 911, 913, 916, 925, 943, 946,
D2/976, 978
CPC A43B 23/00; A43B 23/24; A43B 3/0078;
A43B 11/00

Primary Examiner — T Chase Nelson

(57) **CLAIM**

The ornamental design for a shoe strap extension, as shown and described.

See application file for complete search history.

DESCRIPTION

(56) **References Cited**

U.S. PATENT DOCUMENTS

189,333 A * 4/1877 Bibbins A43C 1/00
36/50.1
D29,037 S * 7/1898 Gaisman D2/627
D35,767 S * 2/1902 Krause D2/627
841,157 A * 1/1907 Knothe A41F 9/002
2/338
846,476 A * 3/1907 Hynard A44B 11/22
24/174
D140,270 S * 2/1945 Sharp D2/627
D163,224 S * 5/1951 Reiter D2/639
D312,370 S * 11/1990 Weed D6/563
D359,836 S * 7/1995 Shuler D29/101.5
D381,787 S * 8/1997 Littleton D2/627
D392,436 S * 3/1998 Tassominos D2/627

FIG. 1 is an isometric view of a shoe strap extension showing my new design;
FIG. 2 is a front elevational view thereof;
FIG. 3 is a rear elevational view thereof;
FIG. 4 is a left side elevational view thereof;
FIG. 5 is a right elevational view thereof;
FIG. 6 is a top plan view thereof;
FIG. 7 is a bottom plan view thereof; and,
FIG. 8 is a view of my design in an operational setting. The broken lines in the FIG. 8 view show an additional shoe strap extension, environmental structure in the form of shoes and legs, and the cutoff boundary of the environmental structure. None of the broken lines form a part of the claimed design.

1 Claim, 5 Drawing Sheets

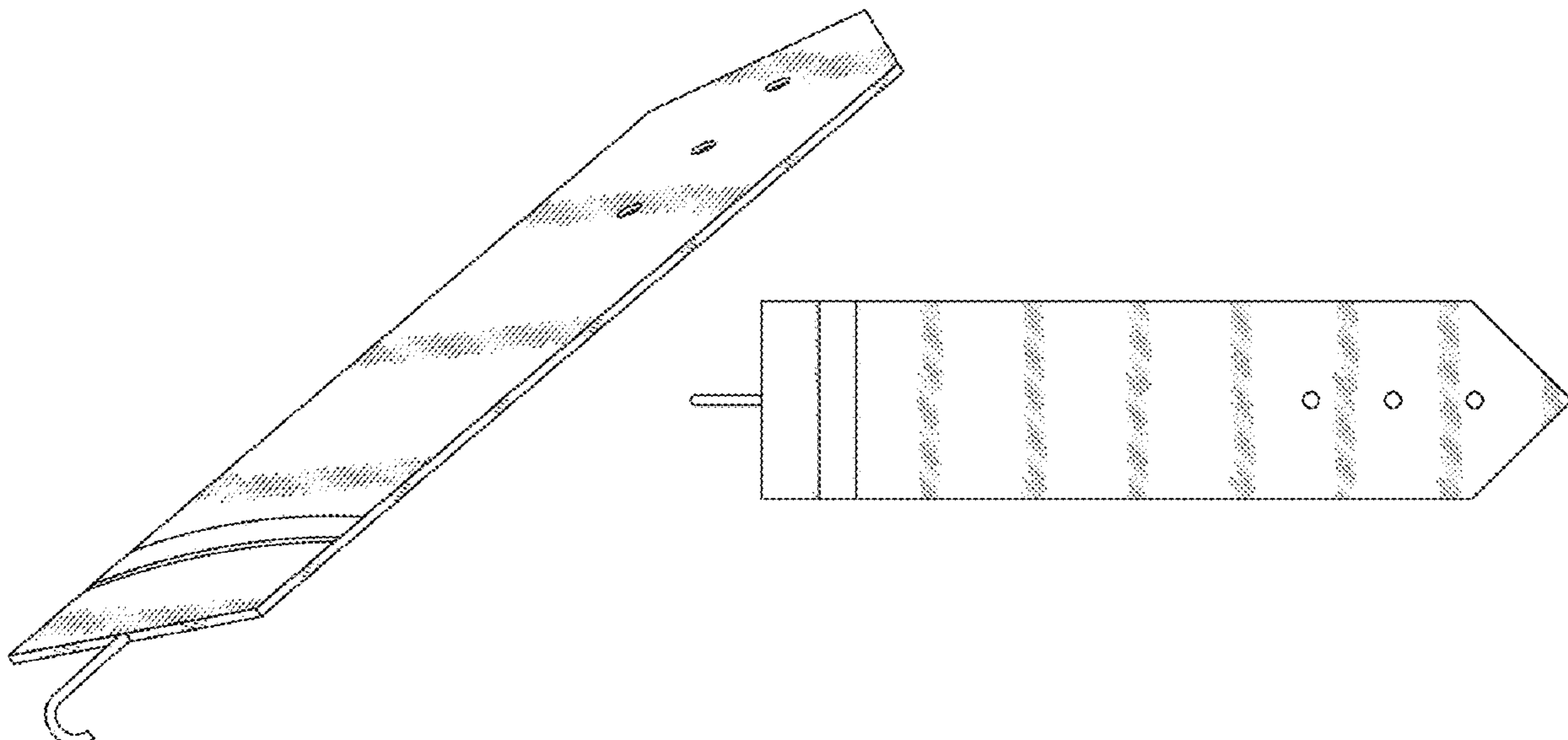

(56)

References Cited

U.S. PATENT DOCUMENTS

D517,775 S * 3/2006 Cook A41F 9/002
 D2/627
 D543,339 S * 5/2007 Choi D2/946
 D568,579 S * 5/2008 Mouquet D2/624
 D585,180 S * 1/2009 Mouquet D2/627
 D589,691 S * 4/2009 Wilkinson D2/971
 D590,140 S * 4/2009 Della Valle
 D599,080 S * 9/2009 Pantoja D2/627
 D599,983 S * 9/2009 Kim D2/901
 D602,685 S * 10/2009 Barteet D2/976
 8,015,623 B2 * 9/2011 Lee A41F 9/002
 2/311
 D650,565 S * 12/2011 Guers-Neyraud D2/971
 D661,462 S * 6/2012 Mouquet D2/634
 D726,993 S * 4/2015 Ermel D2/627
 D732,286 S * 6/2015 Romo D2/978
 D744,740 S * 12/2015 Kenison D2/978
 D747,866 S * 1/2016 Armstrong D2/978
 D751,282 S * 3/2016 Larue D2/978
 D756,616 S * 5/2016 Darmetko D2/946
 D762,961 S * 8/2016 McClaskie D2/970
 D762,962 S * 8/2016 McClaskie D2/970
 D762,963 S * 8/2016 McClaskie D2/971
 D769,597 S * 10/2016 McClaskie D2/970
 D769,609 S * 10/2016 Rhymes D2/978
 D799,196 S * 10/2017 Ploughman D2/976
 D800,991 S * 10/2017 Gordon D2/627
 D836,903 S * 1/2019 Lindsey D2/978
 D843,103 S * 3/2019 Desaever D2/978
 D845,610 S * 4/2019 Mayden D2/978
 D851,385 S * 6/2019 Kenison D2/971
 D864,535 S * 10/2019 Johnson D2/978

D864,547 S * 10/2019 Fadden D2/976
 D884,334 S * 5/2020 Kenison D2/971
 D896,497 S * 9/2020 Kenison D2/976
 D910,273 S * 2/2021 Wexelbaum A43B 3/126
 D2/639
 11,369,167 B1 * 6/2022 Mayer A43C 19/00
 2011/0209375 A1 * 9/2011 Padgett A44C 5/0069
 40/633
 2013/0326907 A1 * 12/2013 Ahanotu A43B 3/126
 36/58.6
 2019/0151703 A1 * 5/2019 Friebele A43C 19/00
 2022/0047042 A1 * 2/2022 Cortes A43C 11/00
 2022/0095745 A1 * 3/2022 Adeshina A43D 8/16

FOREIGN PATENT DOCUMENTS

WO D063465-003 * 4/2003
 WO D074187-006 * 8/2010
 WO D075726-004 * 4/2011
 WO D080186-002 * 3/2013
 WO D087085-006 * 8/2015
 WO D060364-007 * 7/2022

OTHER PUBLICATIONS

Angela Nuran, Ankle Strap Extender Pair, (2021), Etsy.com, [site visited: Jun. 9, 2022], Available from URL: https://www.etsy.com/au/listing/1010377666/ankle-strap-extender-pair-leather?click_key=ebe27ad55836f0f3f808924e6f226c2a6d3d7945%3A1010377666&click_sum=755e33a3&ref=shop_home_active_2&crt=1 (Year: 2021).*

* cited by examiner

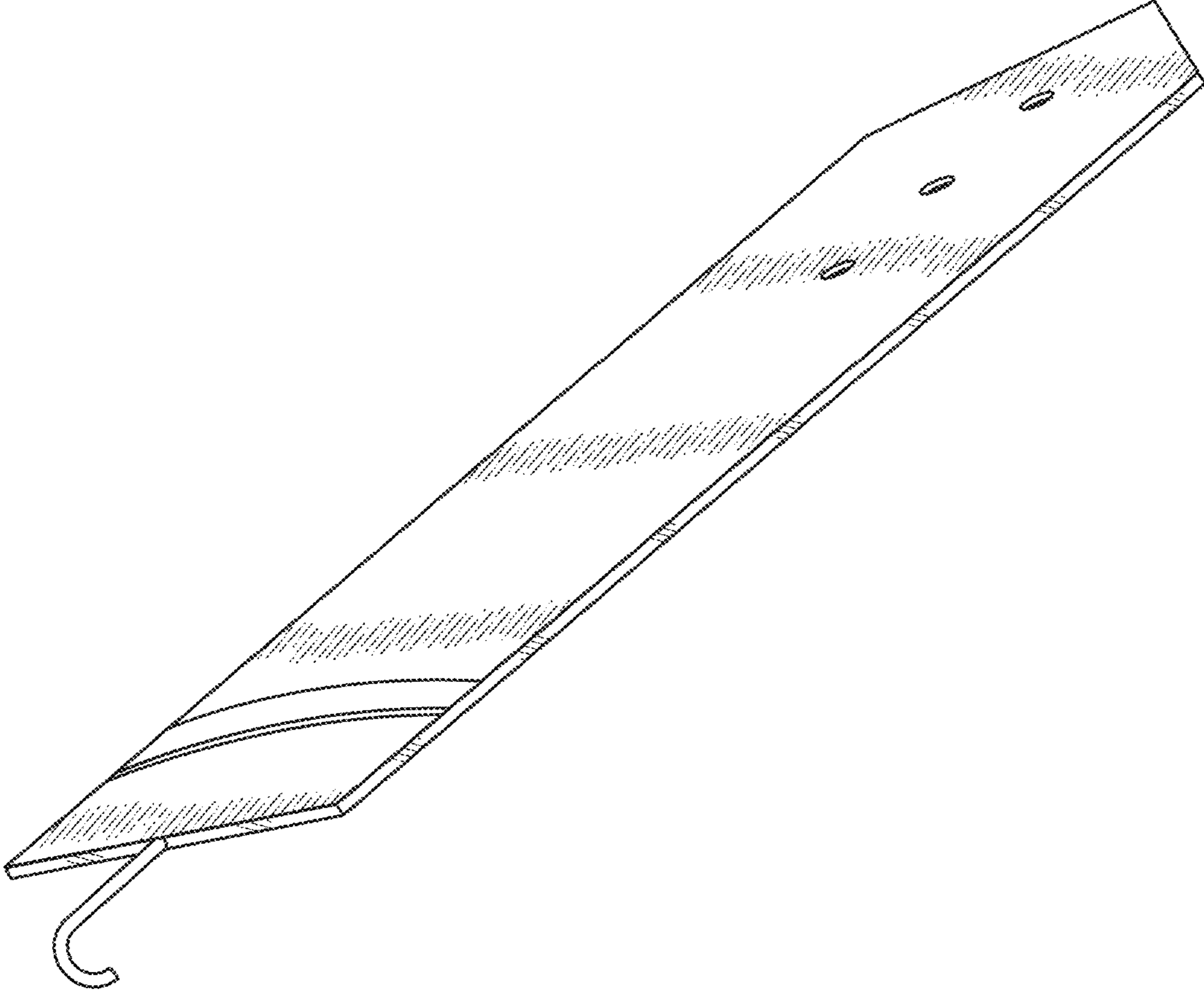

FIG. 1

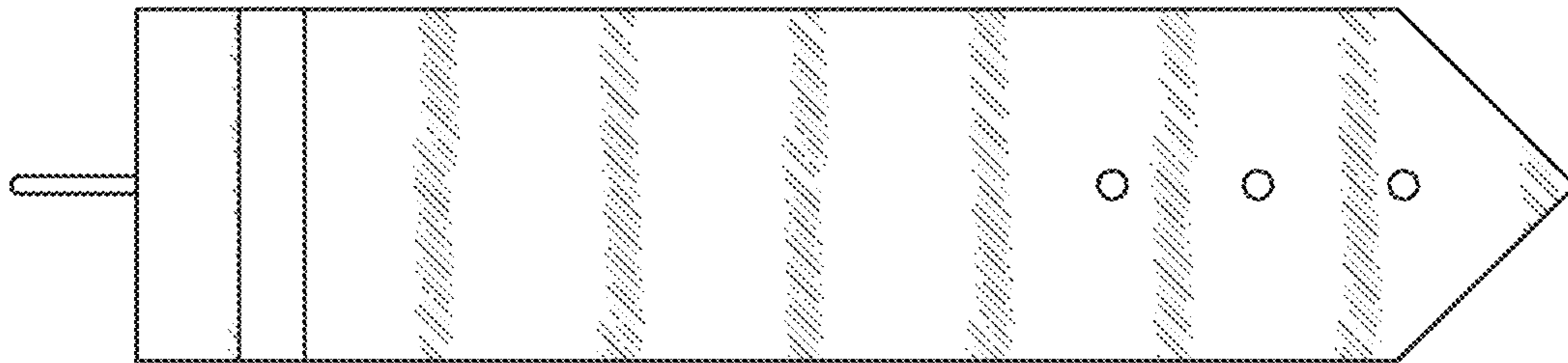

FIG. 2

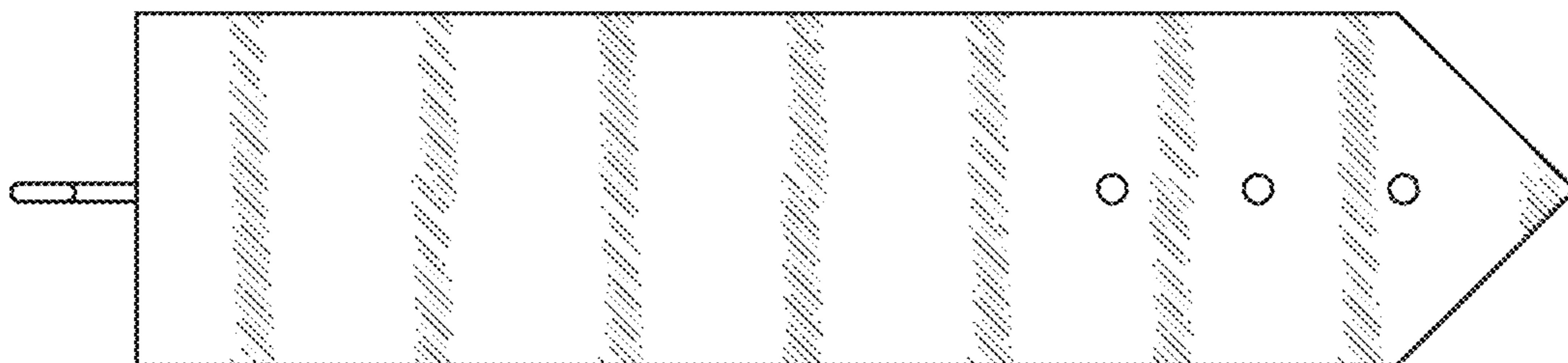

FIG. 3

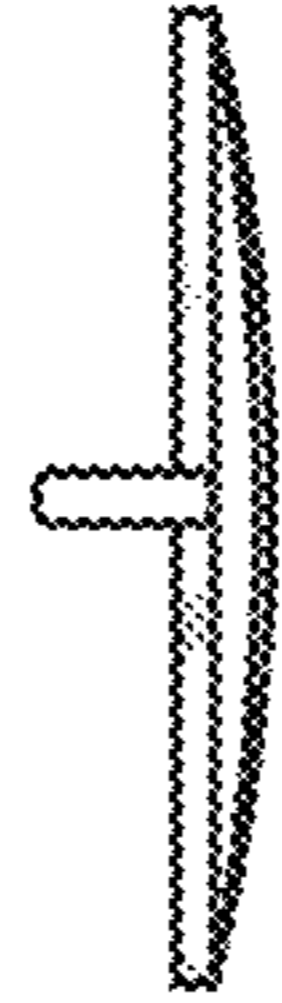

FIG. 4

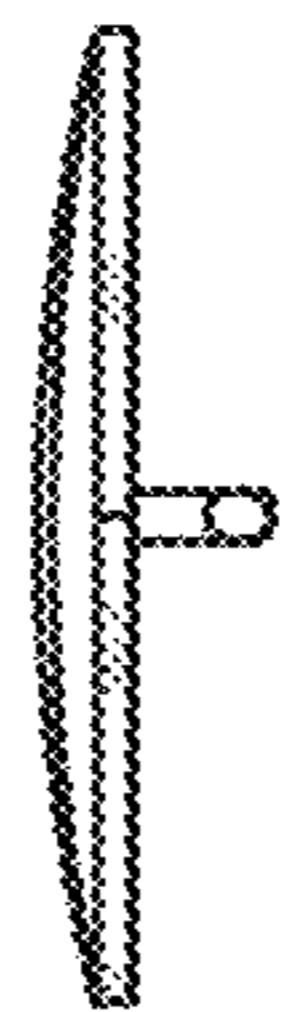

FIG. 5

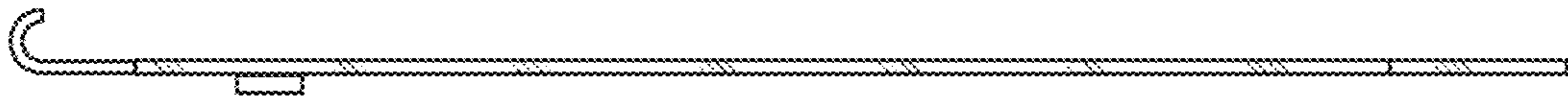

FIG. 6

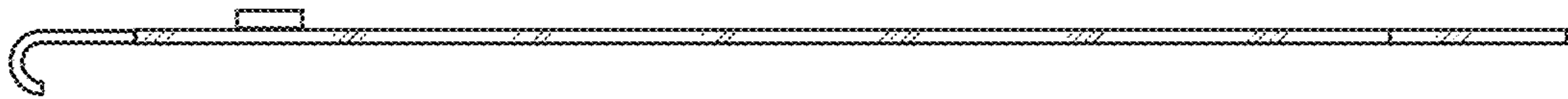

FIG. 7

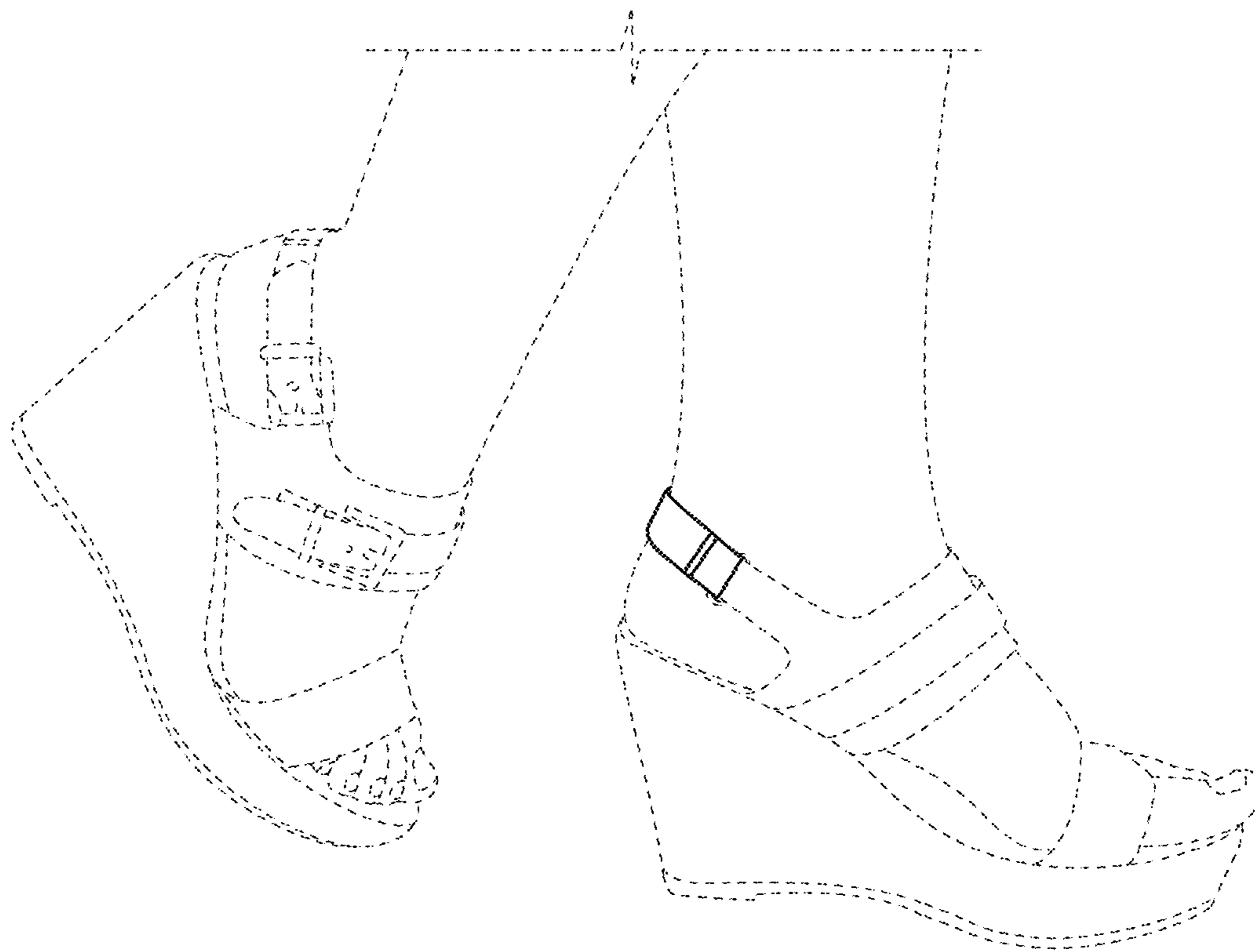

FIG. 8