



US00D977166S

(12) **United States Design Patent**
Zhang

(10) **Patent No.:** **US D977,166 S**

(45) **Date of Patent:** **** Jan. 31, 2023**

(54) **SOLAR LAMP**

(71) Applicant: **Yun Zhang**, Shaoxing (CN)

(72) Inventor: **Yun Zhang**, Shaoxing (CN)

(**) Term: **15 Years**

(21) Appl. No.: **29/807,677**

(22) Filed: **Sep. 14, 2021**

(51) **LOC (14) Cl.** **26-05**

(52) **U.S. Cl.**
USPC **D26/67**

(58) **Field of Classification Search**
USPC D26/67-70, 85
CPC F21S 8/03; F21S 8/033; F21S 8/036; F21S
8/081; F21S 9/037; F21W 2111/02;
F21W 2111/023; F21W 2131/109
See application file for complete search history.

(56) **References Cited**

U.S. PATENT DOCUMENTS

D518,219 S *	3/2006	Bucher	D26/67
D639,989 S *	6/2011	Chen	D26/68
D653,785 S *	2/2012	Chen	D26/68
D672,488 S *	12/2012	Chen	D26/68
D748,315 S	1/2016	Ladewig		
D824,069 S *	7/2018	Chen	D26/67
D824,562 S	7/2018	Chen		
D840,581 S *	2/2019	Chelf	D26/99
D892,381 S *	8/2020	Lin	D26/67
D899,658 S	10/2020	Wang		
D906,564 S	12/2020	Wu		
D908,942 S	1/2021	Pan		
D913,570 S *	3/2021	Chelf	D26/99
D923,229 S	6/2021	Liao		
D953,595 S *	5/2022	Chen	D26/67

OTHER PUBLICATIONS

Hampton Bay Solar Brass Outdoor Pathway Light Set, ASIN: B079J4W7DK. Available from amazon.com Feb. 1, 2018. (Year: 2018).*

Era 6 Pack Solar Pathway Lights, ASIN: B08P5KCDKS. Available from amazon.com Nov. 26, 2020. (Year: 2020).*

Solatino Solar Pathway Light, ASIN: B0B3D46ZXW. Available from amazon.com Jun. 7, 2022. (Year: 2022).*

Insome Solar Outdoor Lights, ASIN: B08ZCL1FXX. Available from amazon.com Mar. 18, 2021. (Year: 2021).*

* cited by examiner

Primary Examiner — Clare E Heflin

(74) *Attorney, Agent, or Firm* — Rumit Ranjit Kanakia

(57) **CLAIM**

I claim the ornamental design for a solar lamp, as shown and described.

DESCRIPTION

FIG. 1 is a Perspective view of a solar lamp showing my new design;

FIG. 2 is a Front view thereof;

FIG. 3 is a Back view thereof;

FIG. 4 is a Right-side view thereof;

FIG. 5 is a Left-side view thereof;

FIG. 6 is a Top view thereof; and,

FIG. 7 is a Bottom view thereof.

The broken lines in the drawings depict portions of the solar lamp that form no part of the claimed design.

1 Claim, 7 Drawing Sheets

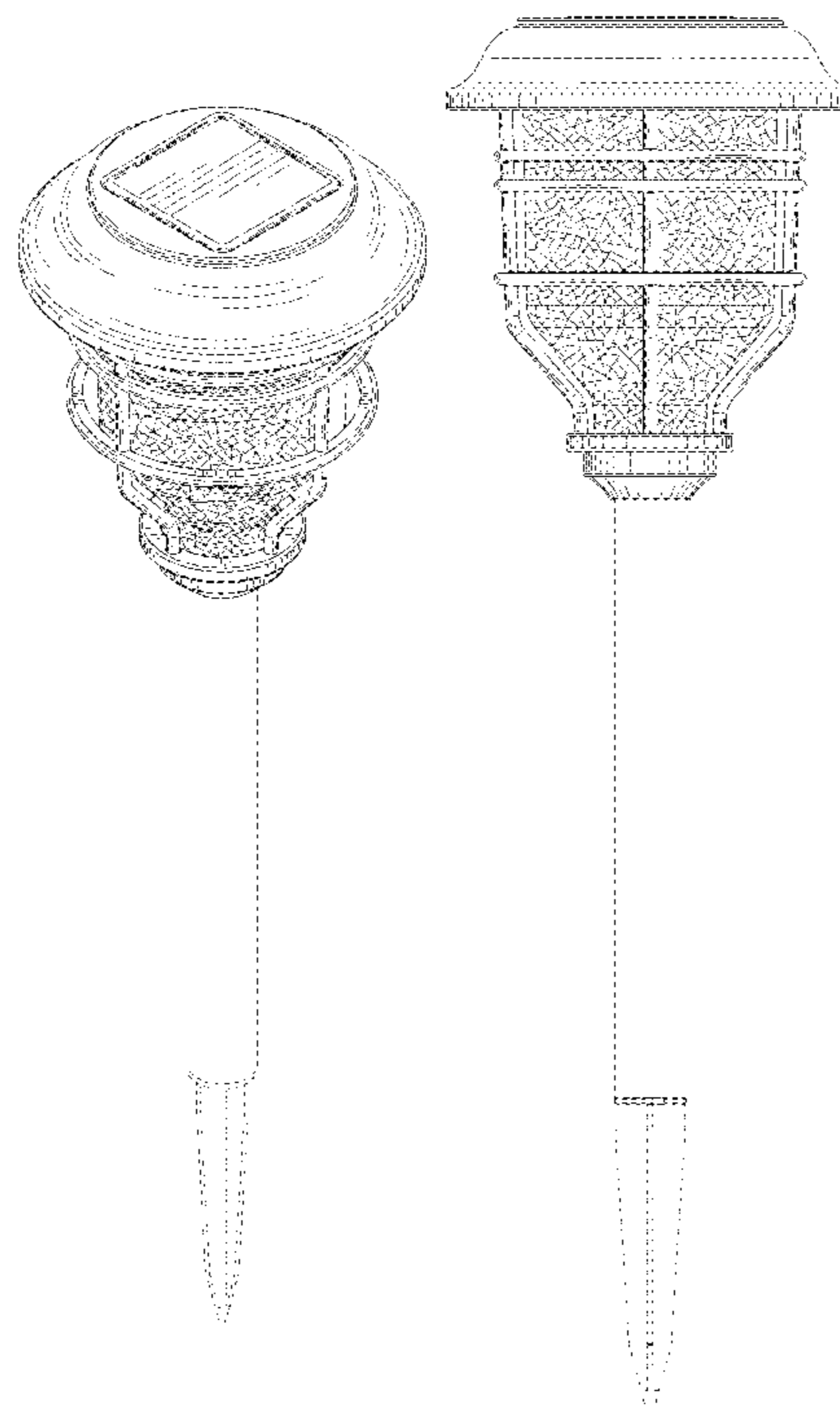

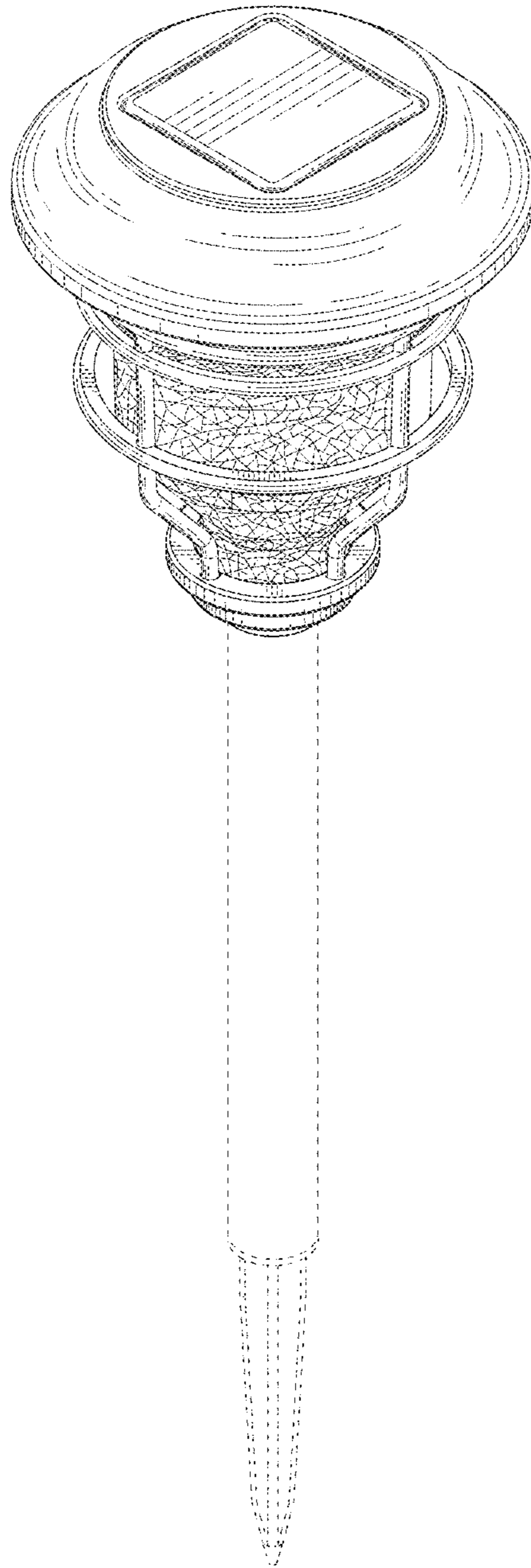

FIG. 1

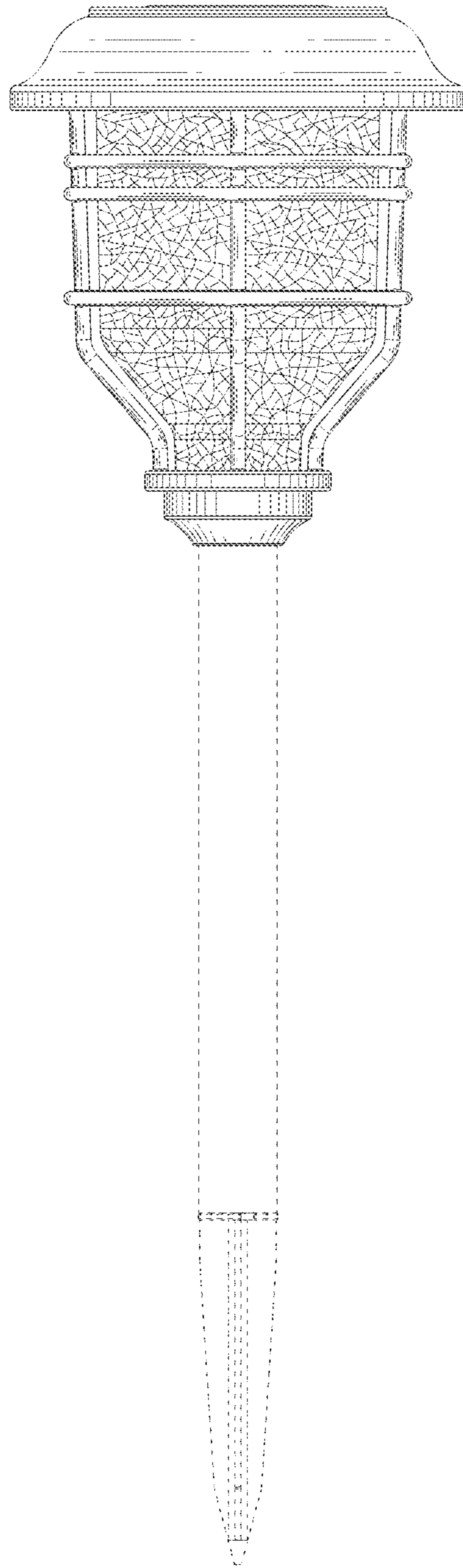

FIG.2

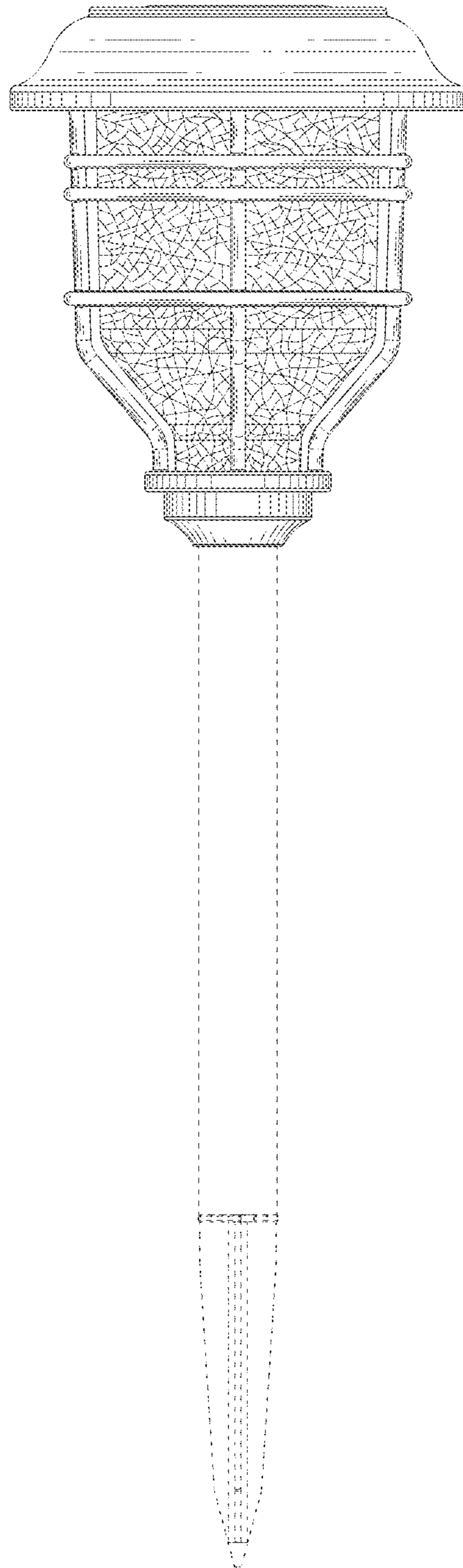

FIG. 3

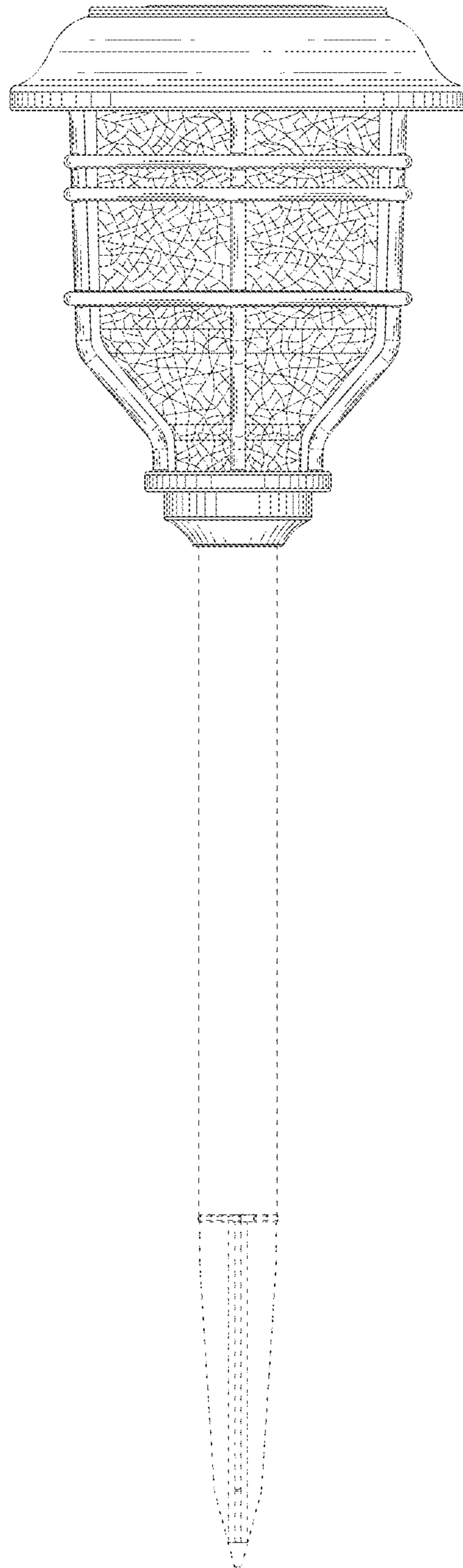

FIG.4

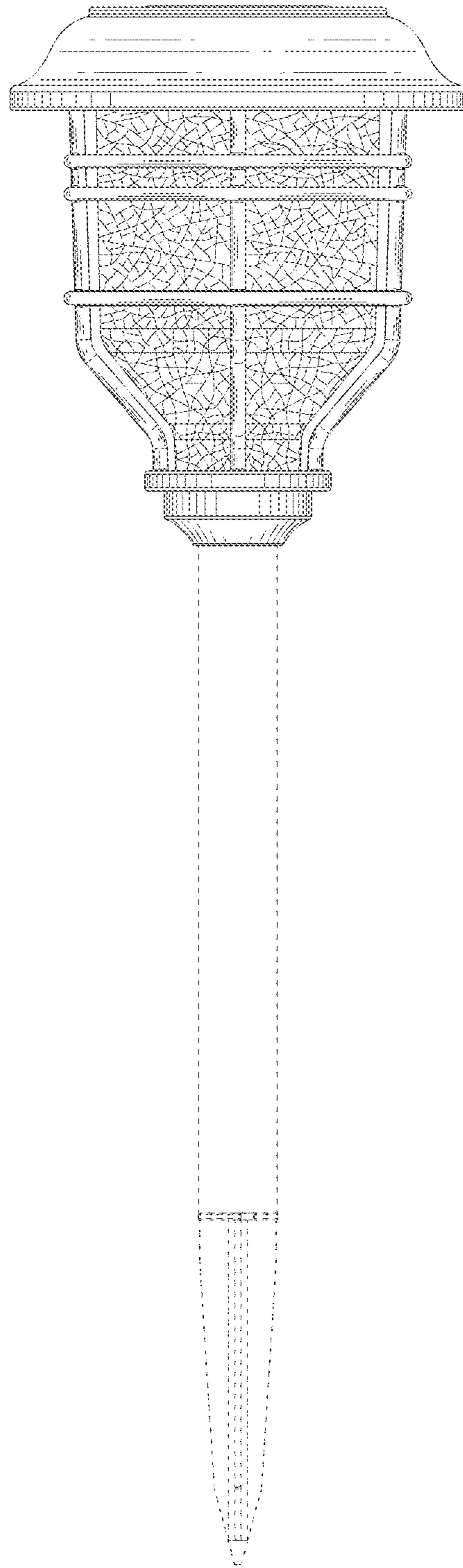

FIG.5

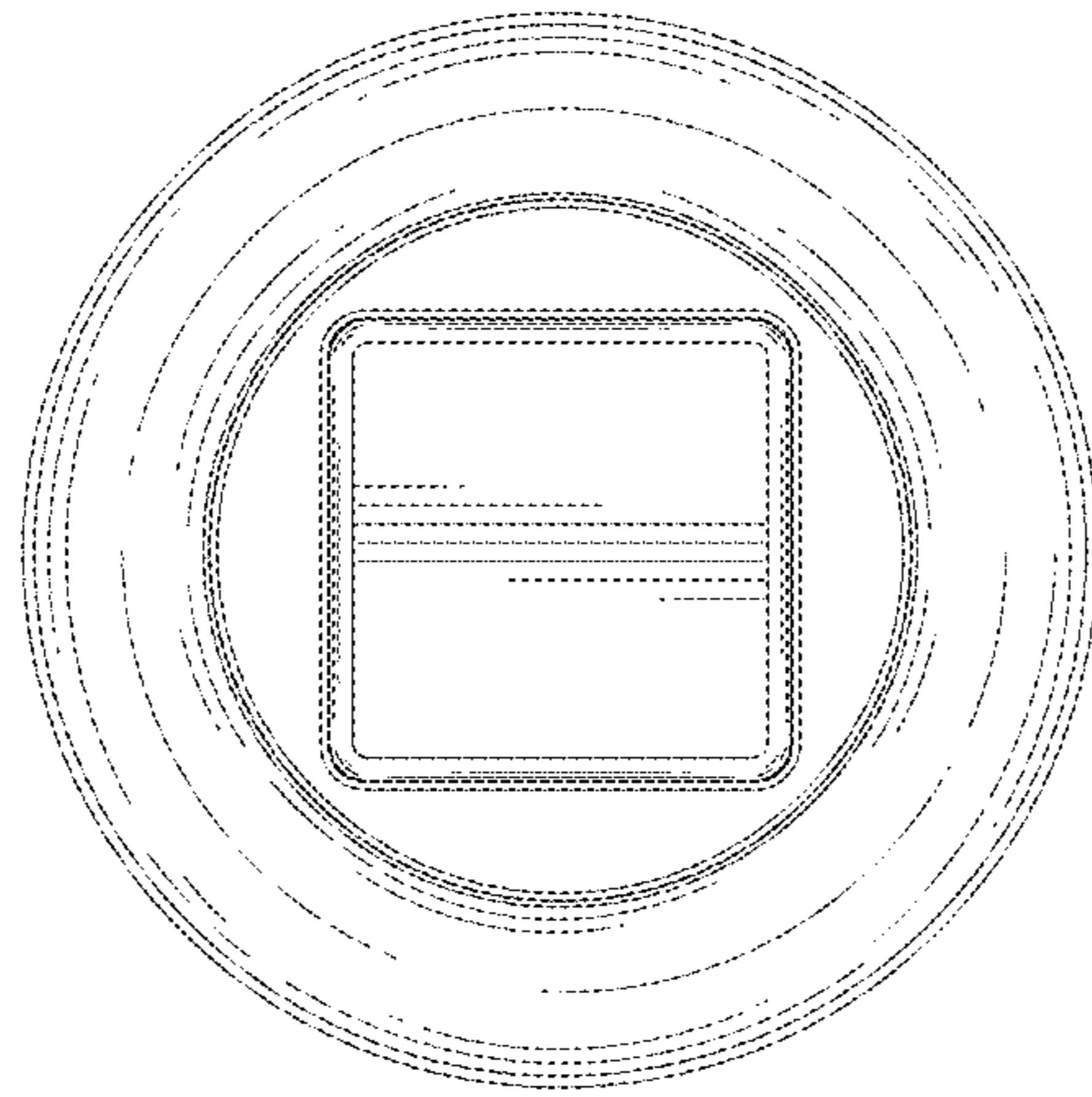

FIG.6

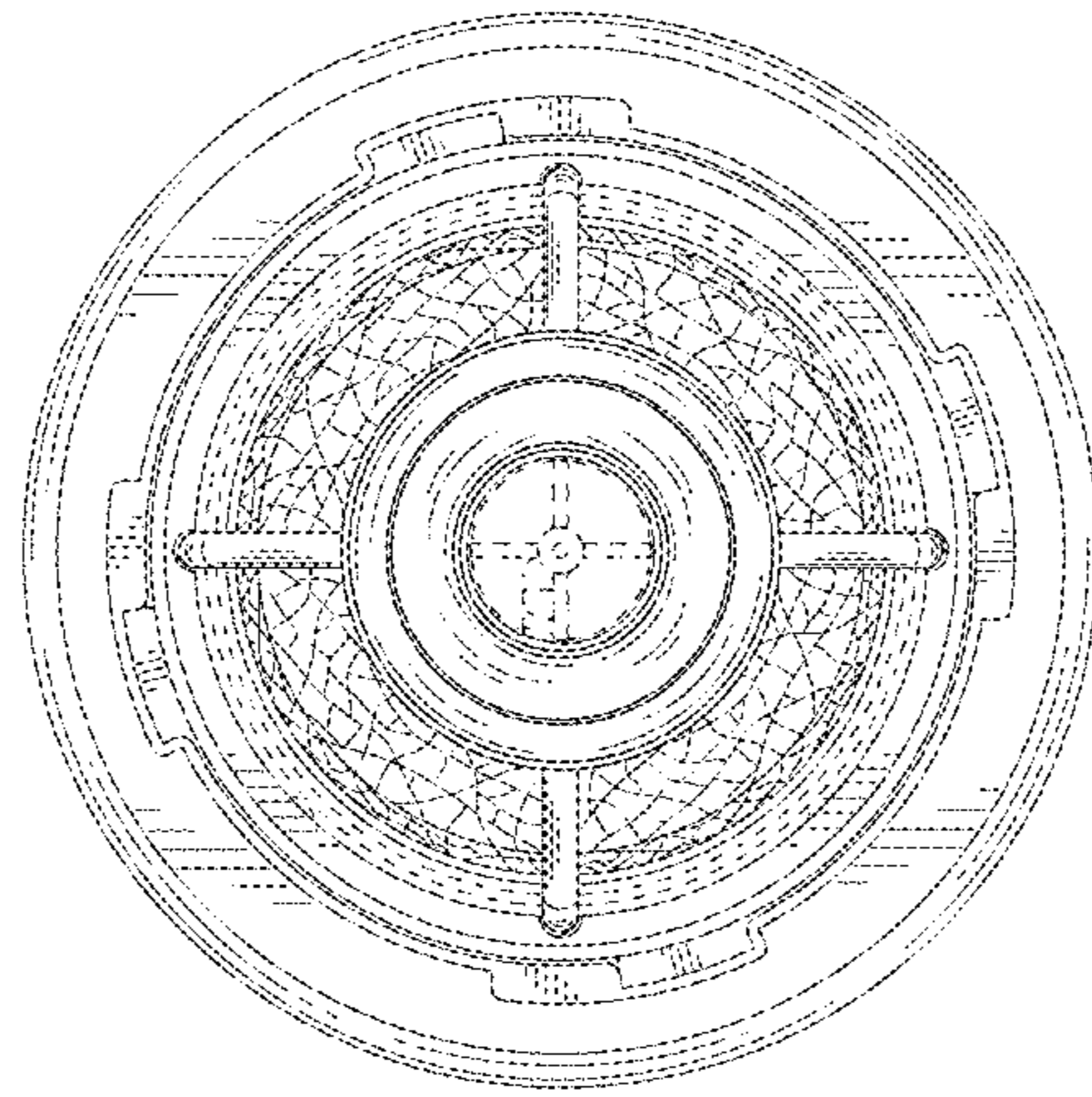

FIG. 7