



US00D977145S

(12) **United States Design Patent**  
**Guan et al.**

(10) **Patent No.:** **US D977,145 S**  
(45) **Date of Patent:** **\*\* Jan. 31, 2023**

(54) **ROOM WITH RETAIL ARRANGEMENT**

(71) Applicant: **Polestar Performance AB**, Gothenburg (SE)

(72) Inventors: **Rong Guan**, Gothenburg (SE); **Marcus Olausson**, Gråbo (SE)

(73) Assignee: **Polestar Performance AB**, Gothenburg (SE)

(\*\*) Term: **15 Years**

(21) Appl. No.: **29/739,232**

(22) Filed: **Jun. 23, 2020**

(51) **LOC (14) Cl.** ..... **25-03**

(52) **U.S. Cl.**  
USPC ..... **D25/1**

(58) **Field of Classification Search**  
USPC ..... D25/1, 3-35, 58; 160/29  
CPC .. E04H 6/00; E04H 6/005; E04H 6/02; E04H 6/08

See application file for complete search history.

(56) **References Cited**

**U.S. PATENT DOCUMENTS**

D395,521 S *	6/1998	De Leu .....	D25/58
D752,241 S *	3/2016	Page .....	D25/1
D771,836 S *	11/2016	Siegel .....	D25/33
D812,771 S *	3/2018	Cully .....	D25/1
D813,411 S *	3/2018	Cully .....	D25/1

D851,780 S *	6/2019	Siegel .....	D25/1
D865,999 S *	11/2019	Wagemans .....	D25/1
D871,612 S *	12/2019	Siegel .....	D25/1
2010/0228666 A1 *	9/2010	Laskowski .....	G06Q 20/40 109/73
2010/0275530 A1 *	11/2010	Laskowski .....	E04H 6/10 362/147
2013/0025802 A1 *	1/2013	Hamelin .....	E06B 9/13 160/269
2015/0036949 A1 *	2/2015	Lasagna .....	E04H 9/145 383/14

\* cited by examiner

*Primary Examiner* — Brett Miller

*Assistant Examiner* — Jasmine L. Comedy

(74) *Attorney, Agent, or Firm* — Patterson Thunte, P.A.

(57) **CLAIM**

We claim the ornamental design for a room with retail arrangement, as shown and described.

**DESCRIPTION**

FIG. 1 is an outer front perspective view of a room with retail arrangement.

FIG. 2 is an inner rear view thereof.

FIG. 3 is an inner front view thereof.

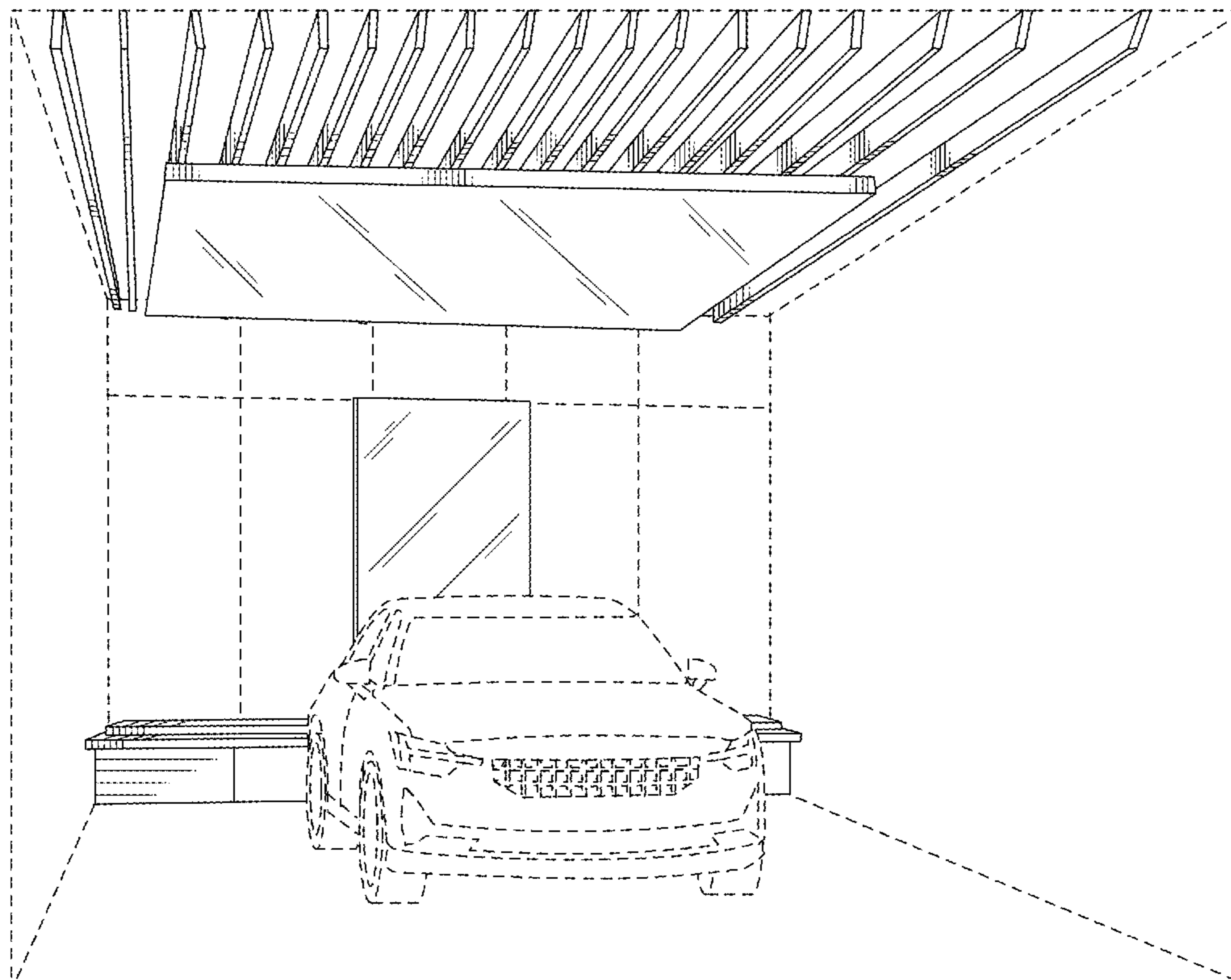
FIG. 4 is an inner left side view thereof.

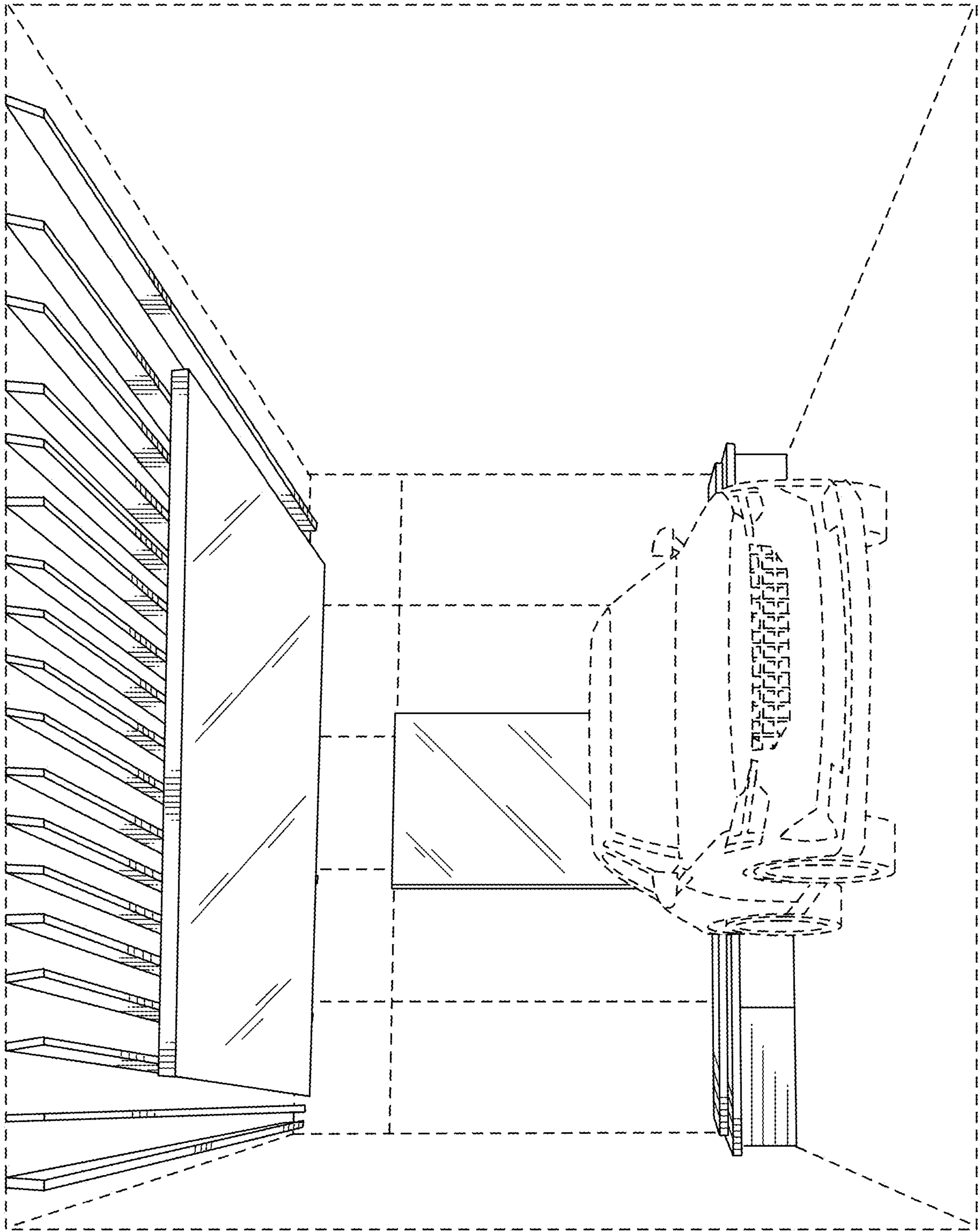
FIG. 5 is an inner right side view thereof; and,

FIG. 6 is an inner top view thereof.

The broken lines in the drawings illustrate portions of the room with retail arrangement or environment that form no part of the claimed design.

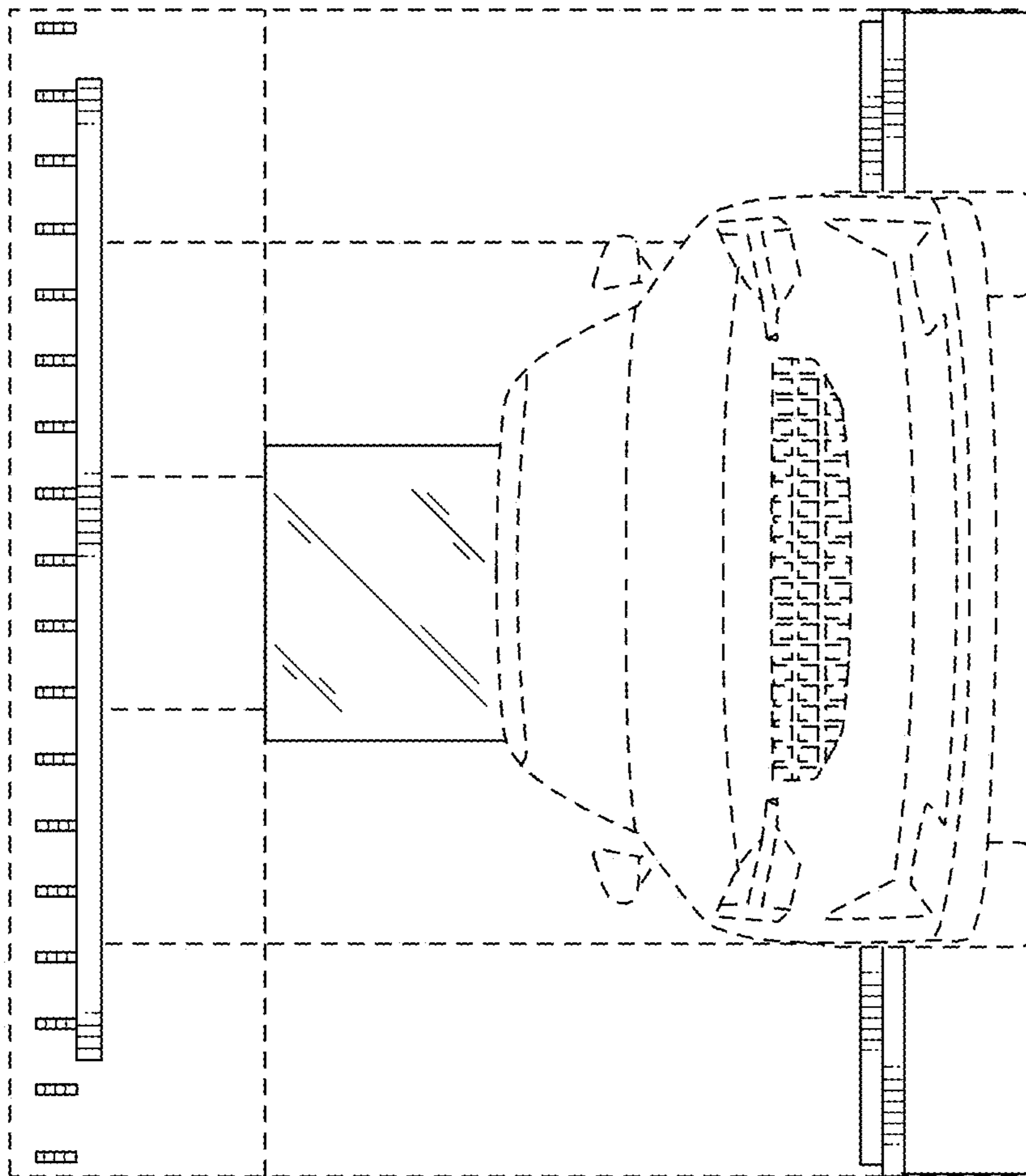
**1 Claim, 6 Drawing Sheets**



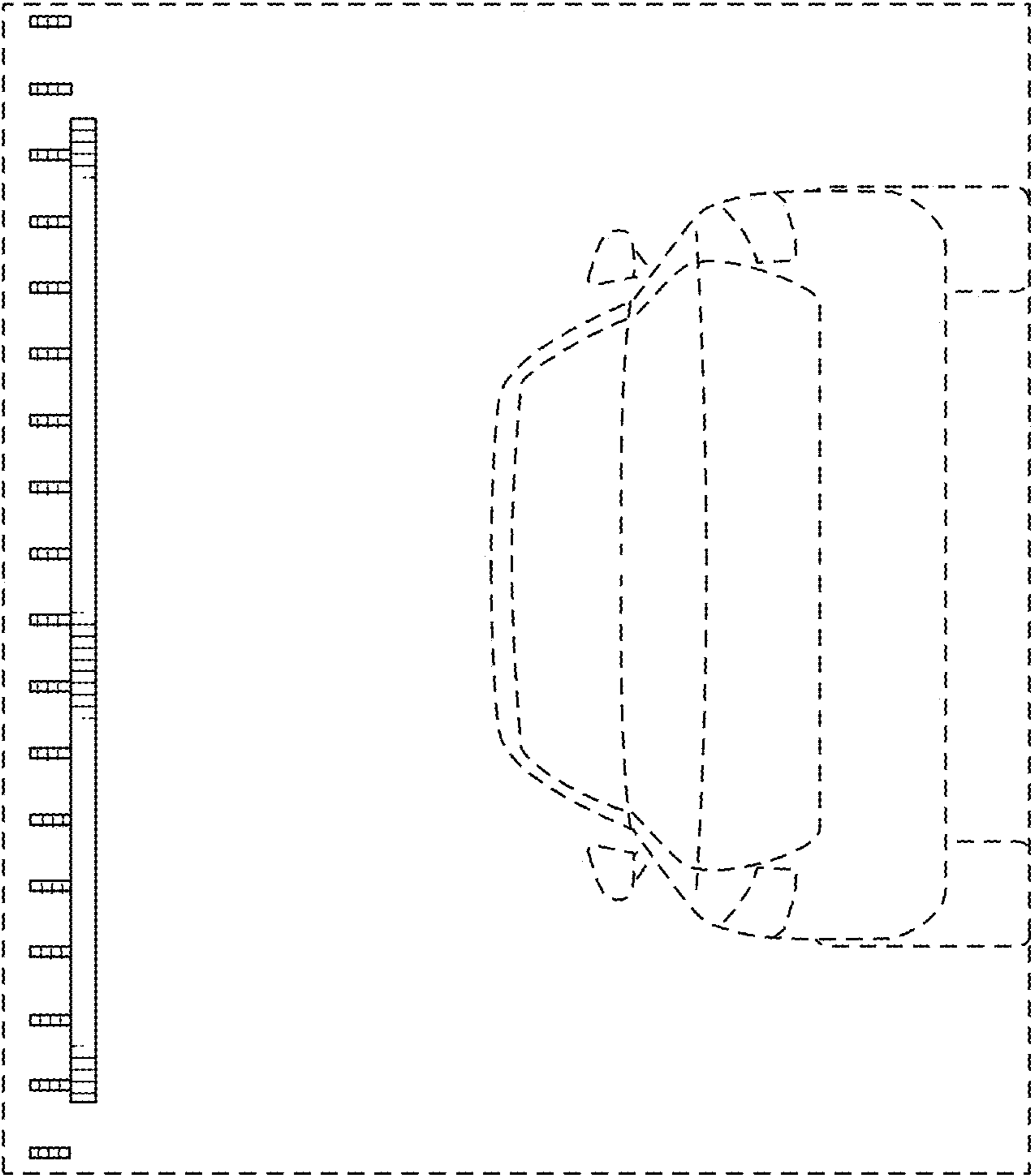


**FIG. 1**

**FIG. 2**

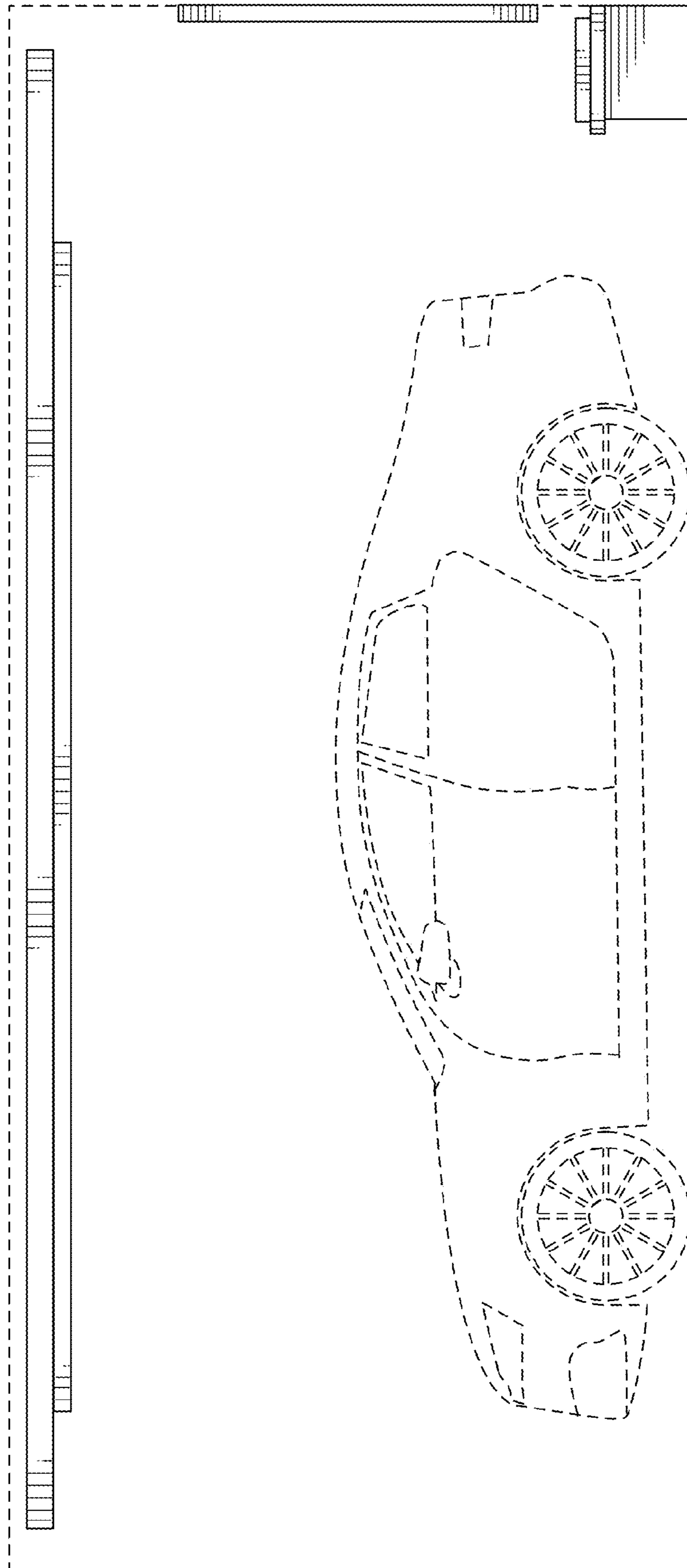


**FIG. 3**

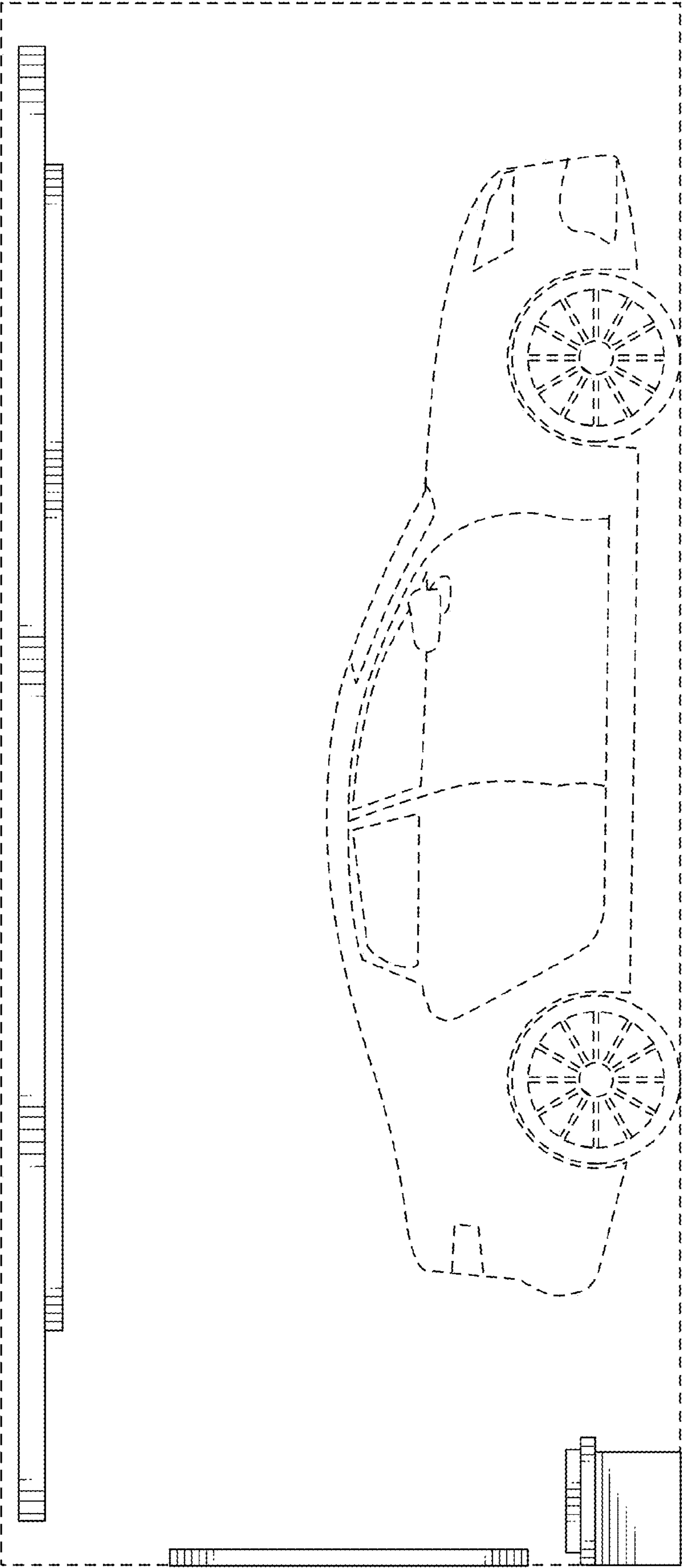


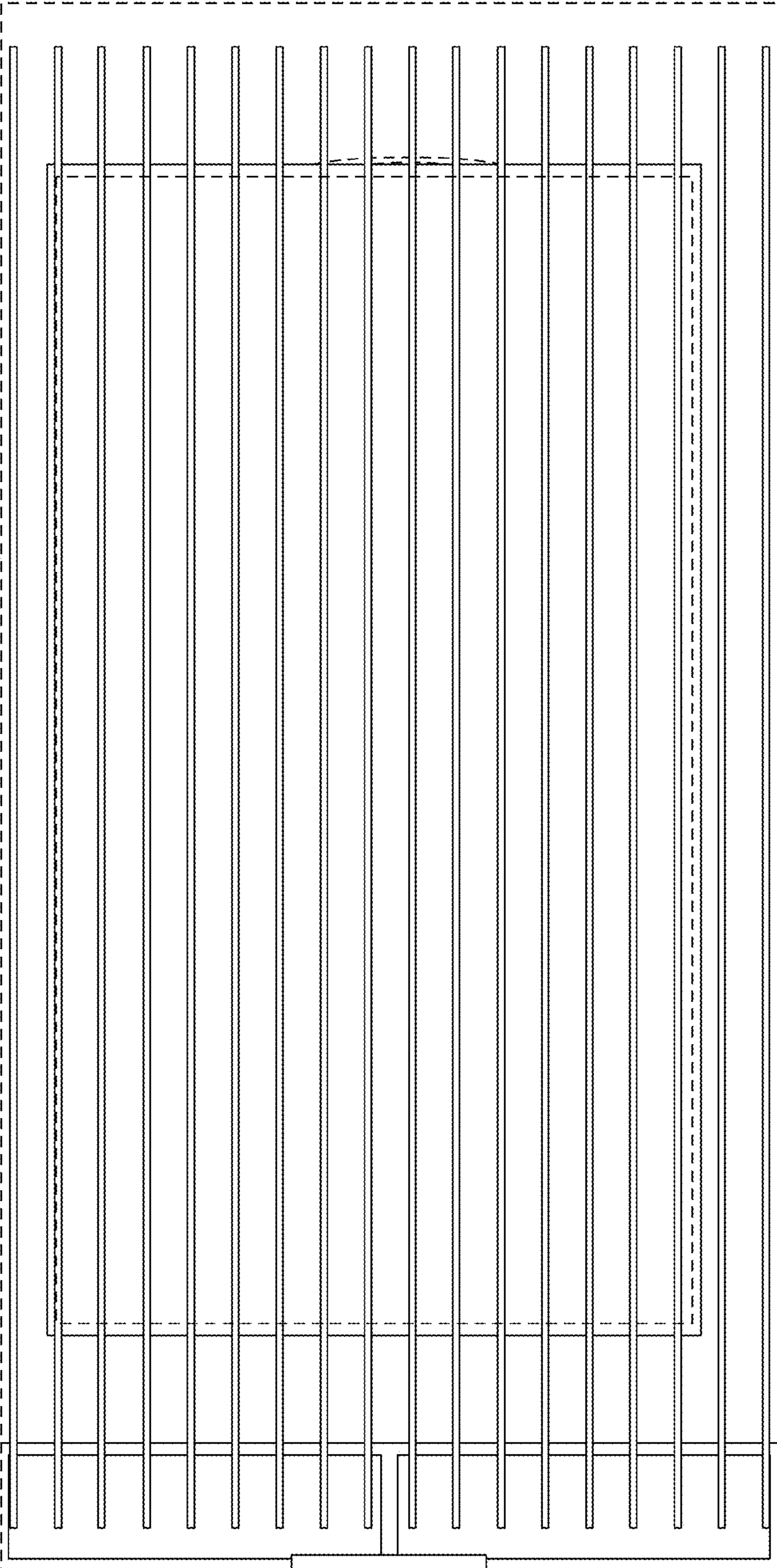


**FIG. 4**



**FIG. 5**





**FIG. 6**