

US00D976977S

(12) **United States Design Patent**
Huang

(10) **Patent No.:** **US D976,977 S**
(45) **Date of Patent:** **** Jan. 31, 2023**

(54) **WINDER FOR WATCHES**

(71) Applicant: **Yuemi Huang**, Shenzhen (CN)

(72) Inventor: **Yuemi Huang**, Shenzhen (CN)

(**) Term: **15 Years**

(21) Appl. No.: **29/755,190**

(22) Filed: **Oct. 19, 2020**

(30) **Foreign Application Priority Data**

Apr. 23, 2020 (EM) 007832316

(51) **LOC (14) Cl.** **15-99**

(52) **U.S. Cl.**
USPC **D15/199**

(58) **Field of Classification Search**
USPC D3/273, 274, 278, 283, 284, 286, 288,
D3/294, 302, 309, 310, 315, 319, 903,
D3/201, 208, 217, 266; D15/199
CPC G04B 5/00; G04D 7/009
See application file for complete search history.

(56) **References Cited**

U.S. PATENT DOCUMENTS

- D511,537 S * 11/2005 Huang G04D 7/009
D15/199
- D512,448 S * 12/2005 Christianson D15/199
- D513,024 S * 12/2005 Christianson G04D 7/009
D15/199
- D543,054 S * 5/2007 Au G04D 7/009
D3/298
- D556,227 S * 11/2007 Au D15/199
- D722,633 S * 2/2015 Au D15/199
- D781,944 S * 3/2017 Lee D15/199
- D886,879 S * 6/2020 Liu D15/199
- D886,880 S * 6/2020 Liu D15/199
- D905,144 S * 12/2020 Liang D15/199
- D905,773 S * 12/2020 Liang D15/199

- D930,059 S * 9/2021 Huang D15/199
- D931,923 S * 9/2021 Huang D15/199
- D931,924 S * 9/2021 Huang D15/199
- D932,532 S * 10/2021 Huang D15/199
- D937,921 S * 12/2021 Huang D15/199
- D939,005 S * 12/2021 Huang D15/199
- D945,508 S * 3/2022 Huang D15/199

(Continued)

Primary Examiner — Michael C Stout

Assistant Examiner — Fritzgerald L Butac

(74) *Attorney, Agent, or Firm* — Westbridge IP LLC

(57) **CLAIM**

The ornamental design for a winder for watches, as shown and described.

DESCRIPTION

FIG. 1 is a front perspective view of a winder for watches showing my new design according to a first embodiment; FIG. 2 is a rear perspective view of FIG. 1; FIG. 3 is a front elevational view of FIG. 1; FIG. 4 is a rear elevational view of FIG. 1; FIG. 5 is a left side elevational view of FIG. 1; FIG. 6 is a right side elevational view of FIG. 1; FIG. 7 is a top plan view of FIG. 1; FIG. 8 is a bottom plan view of FIG. 1; FIG. 9 is a front perspective view of a winder for watches showing my new design according to a second embodiment; FIG. 10 is a rear perspective view of FIG. 9; FIG. 11 is a front elevational view of FIG. 9; FIG. 12 is a rear elevational view of FIG. 9; FIG. 13 is a left side elevational view of FIG. 9; FIG. 14 is a right side elevational view of FIG. 9; FIG. 15 is a top plan view of FIG. 9; and, FIG. 16 is a bottom plan view of FIG. 9. The broken lines in the drawings illustrate the portions of the winder for watches which form no part of the claimed design.

1 Claim, 16 Drawing Sheets

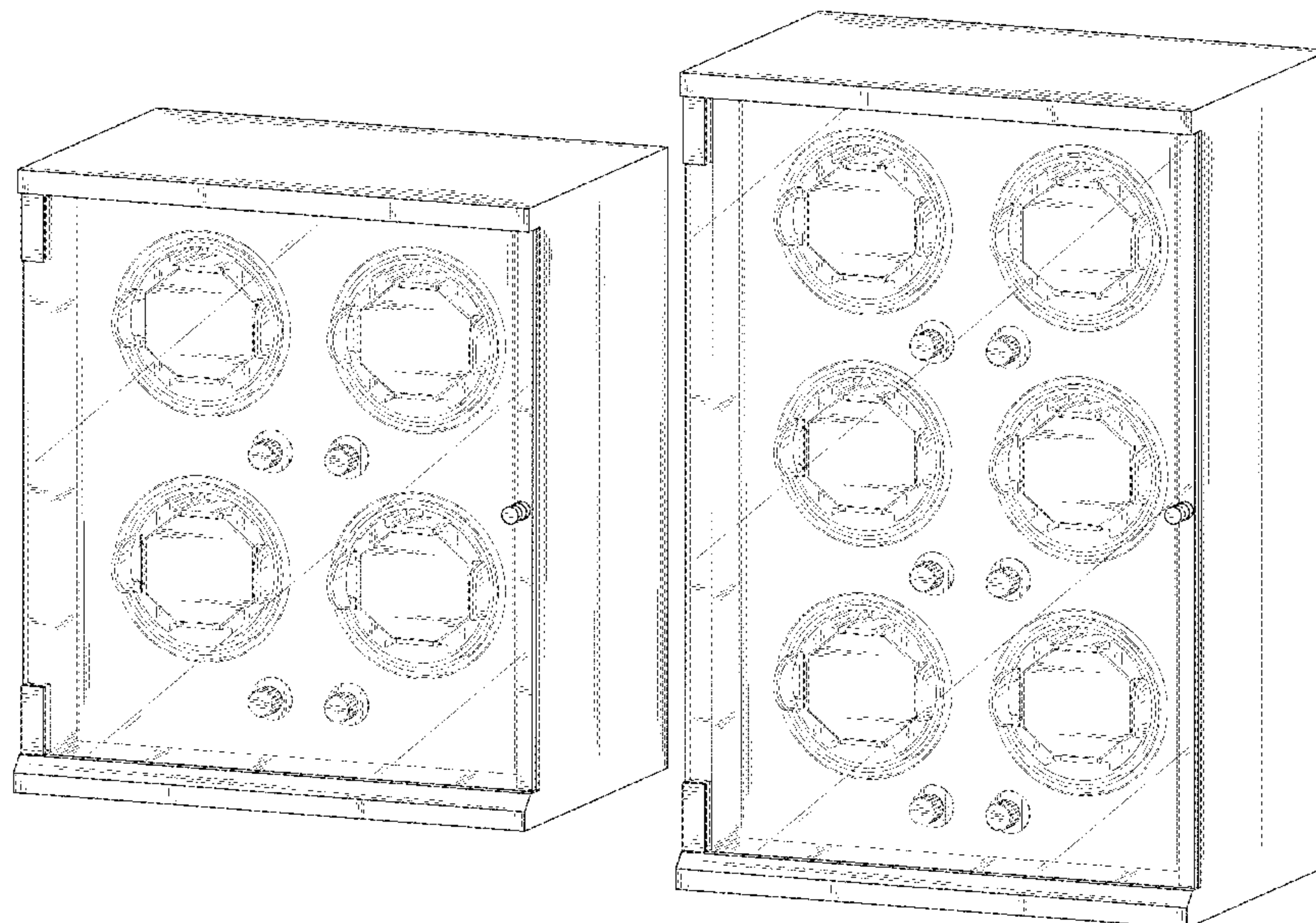

(56)

References Cited

U.S. PATENT DOCUMENTS

D952,722 S * 5/2022 Huang D15/199
D952,723 S * 5/2022 Huang D15/199

* cited by examiner

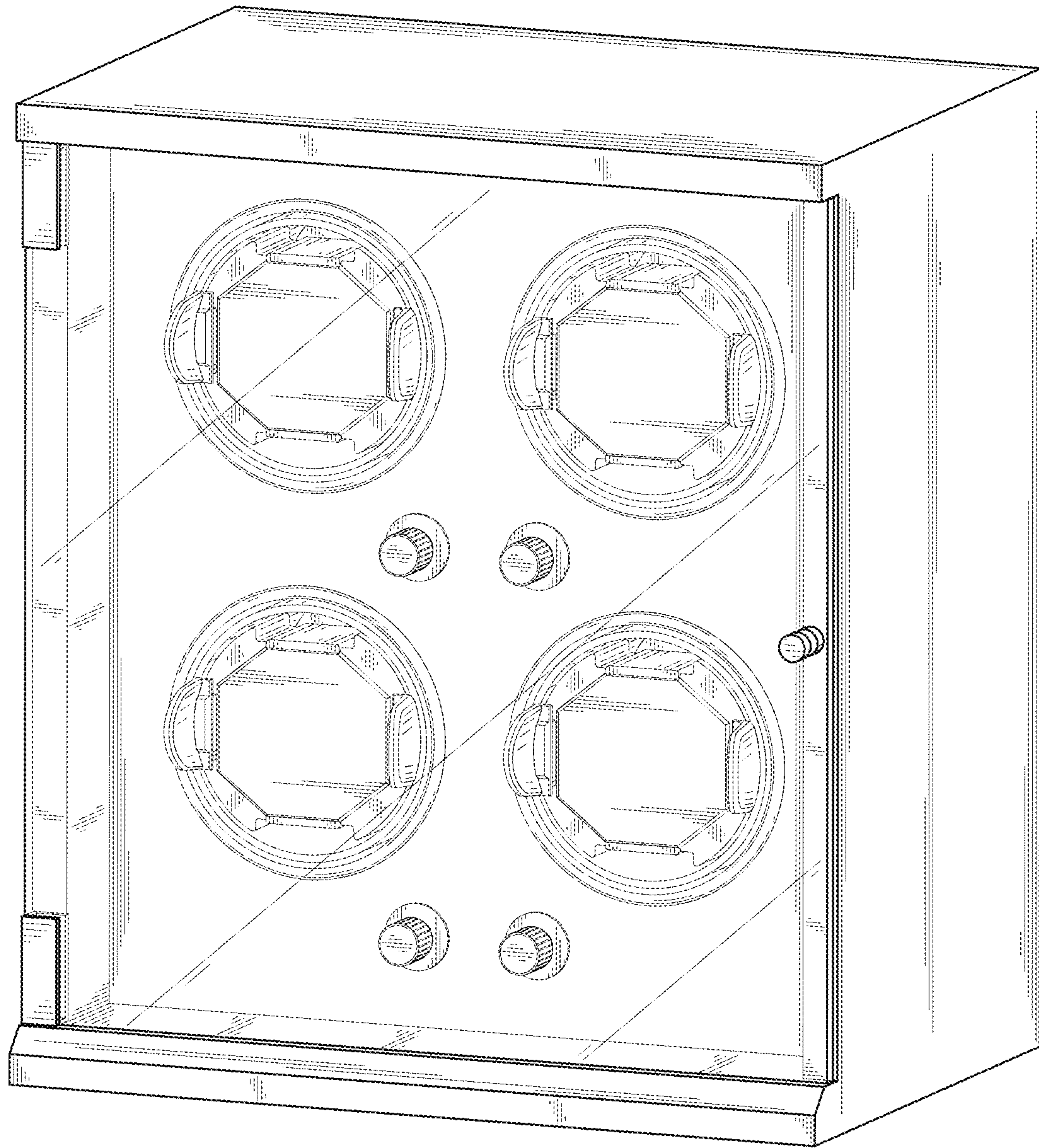

FIG. 1

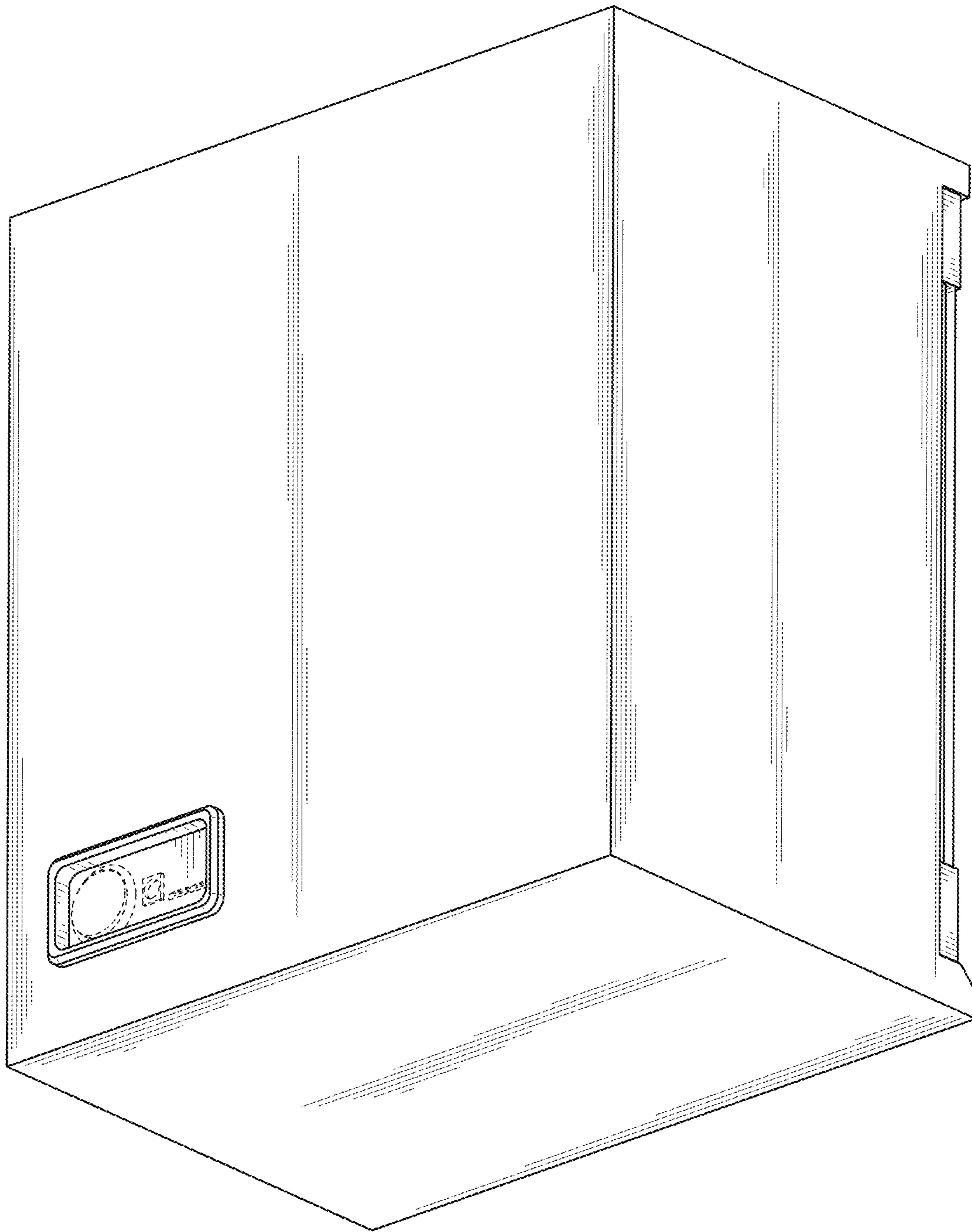

FIG. 2

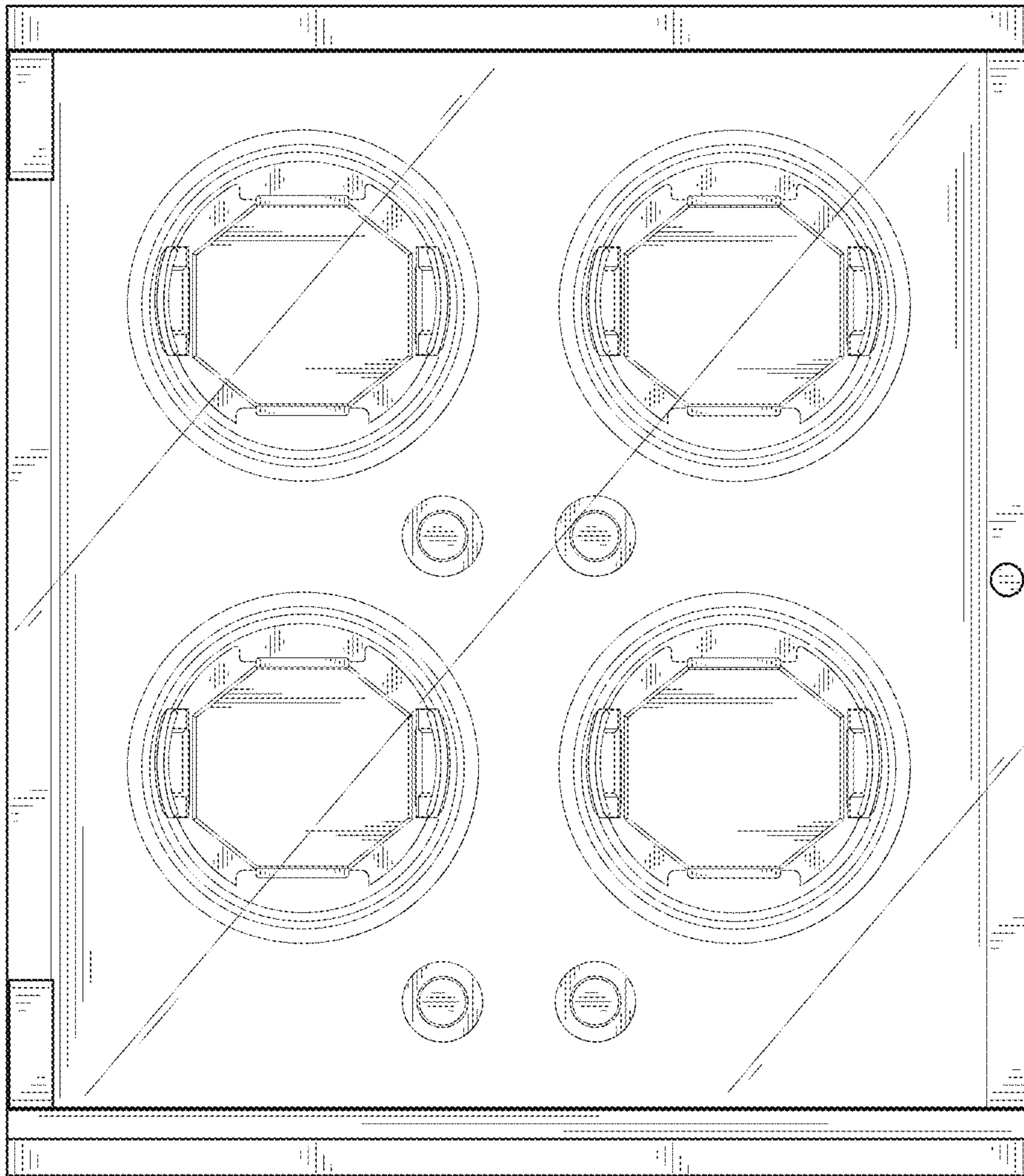

FIG. 3

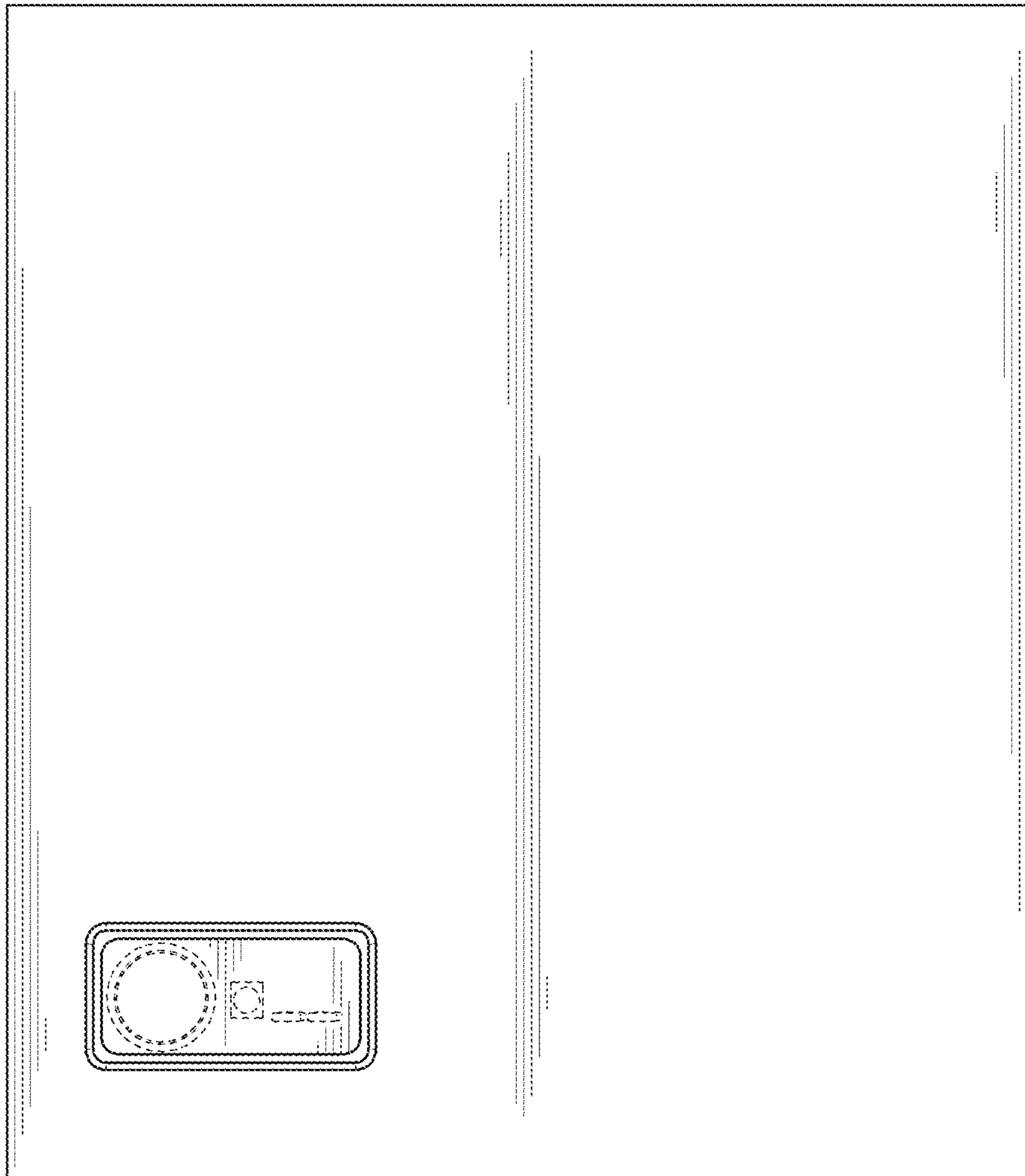

FIG. 4

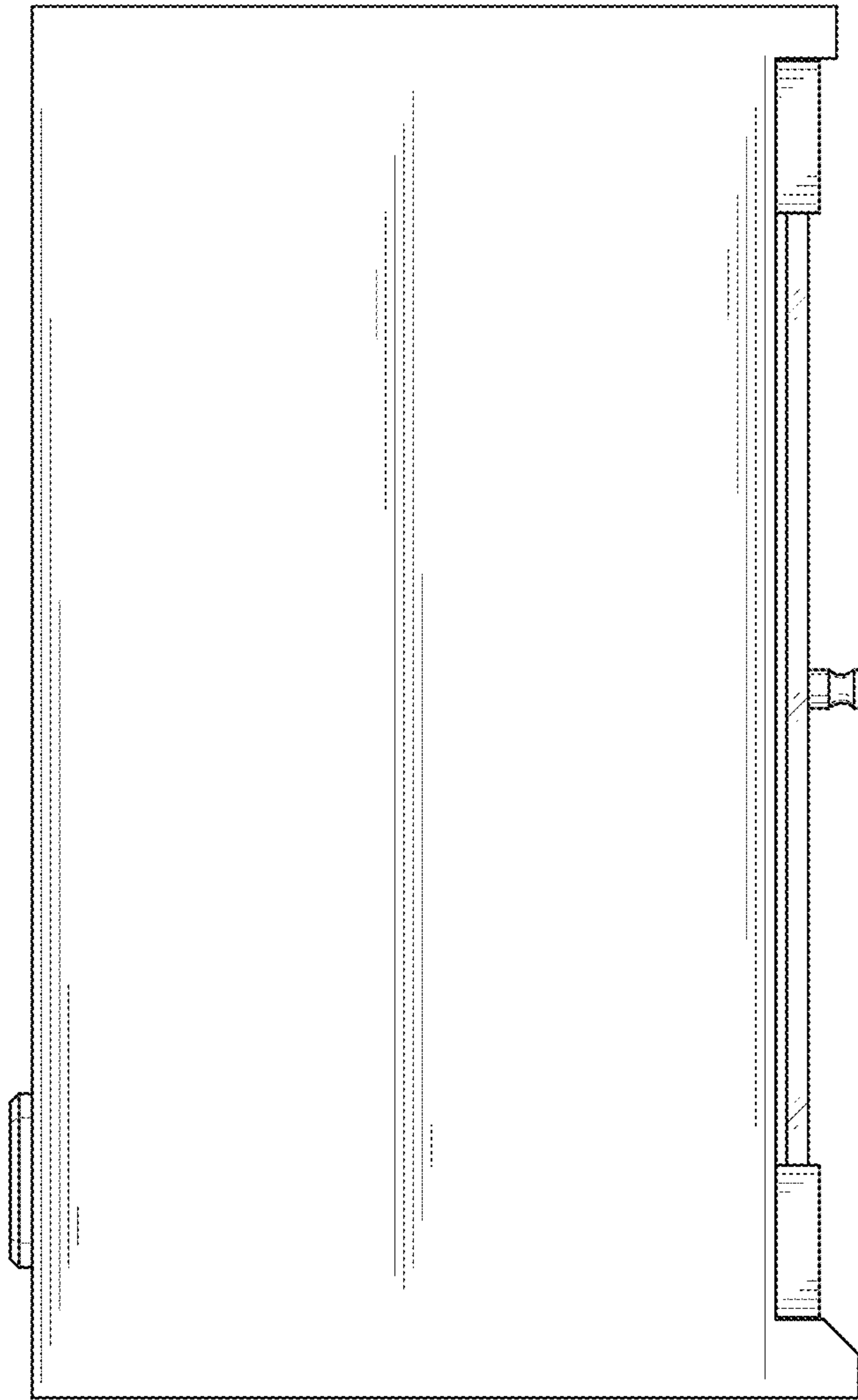

FIG. 5

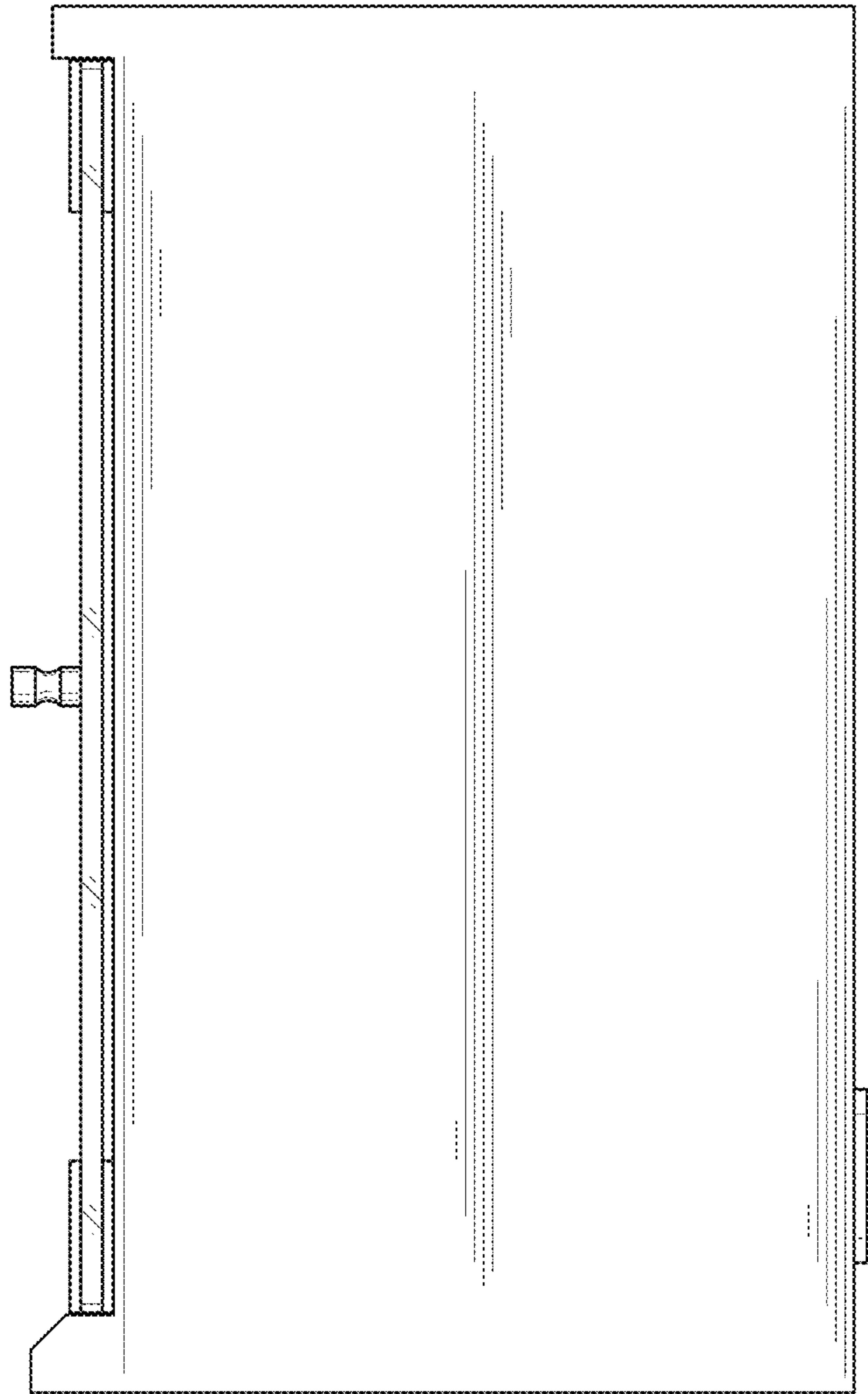

FIG. 6

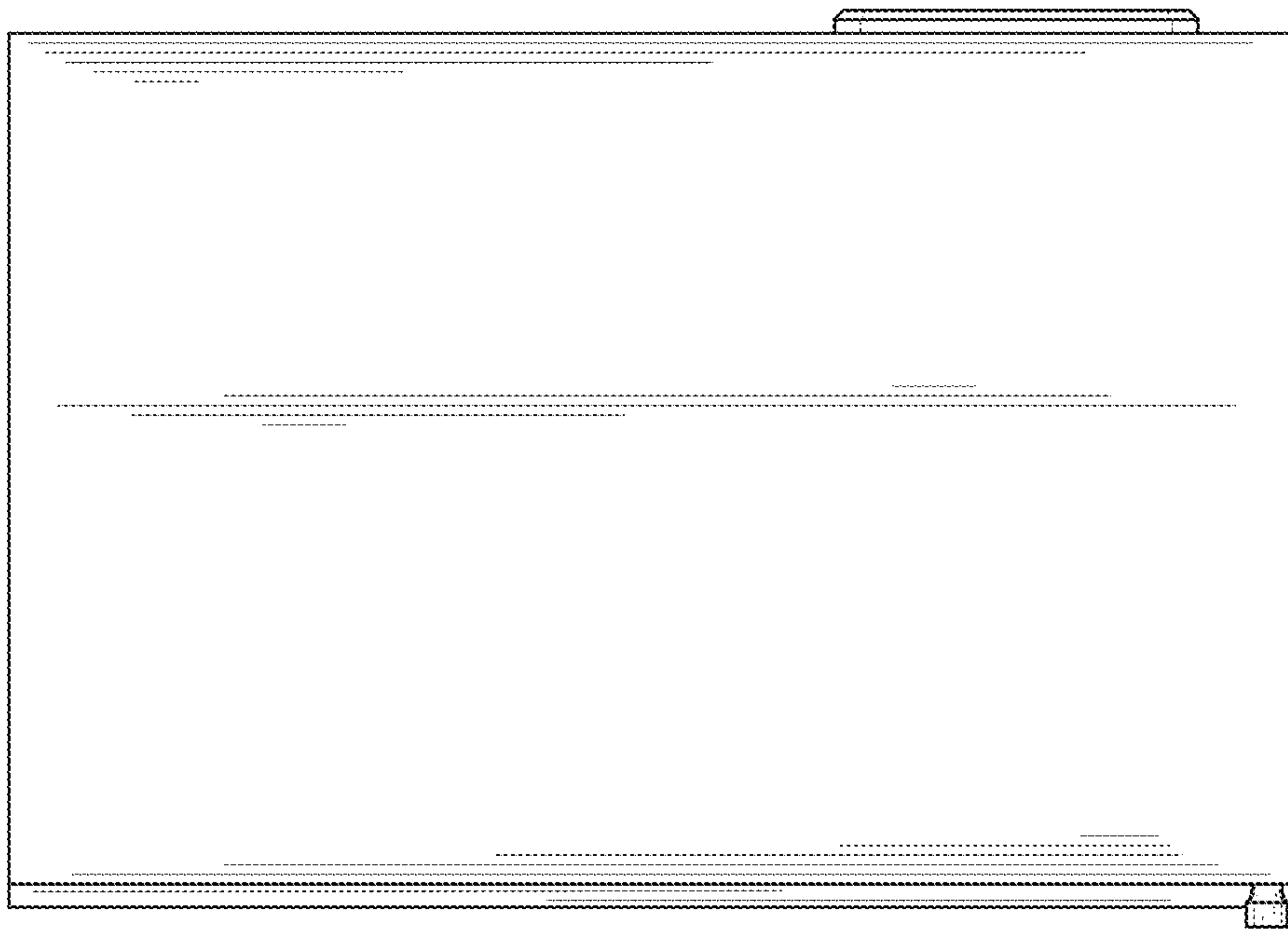

FIG. 7

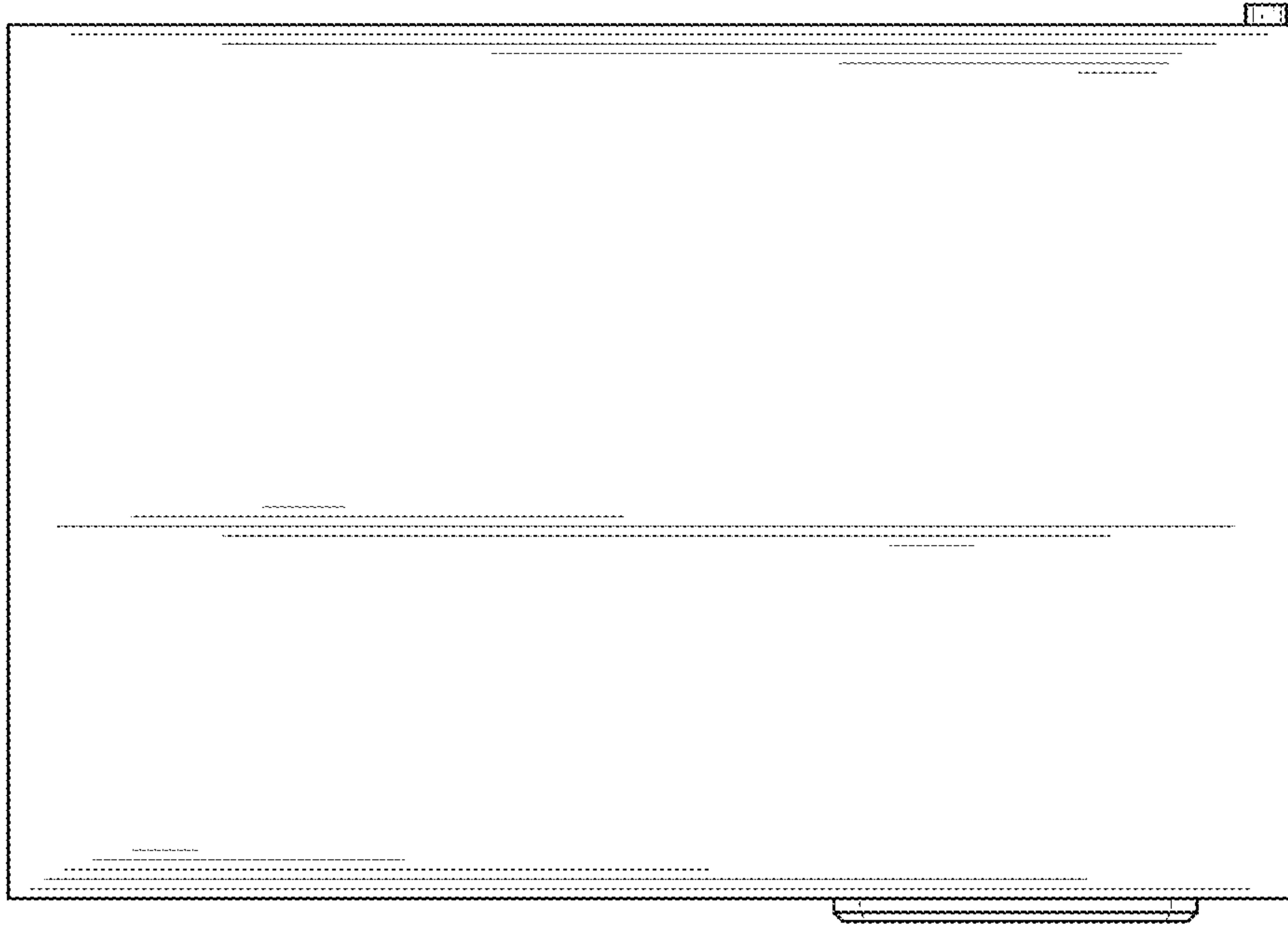

FIG. 8

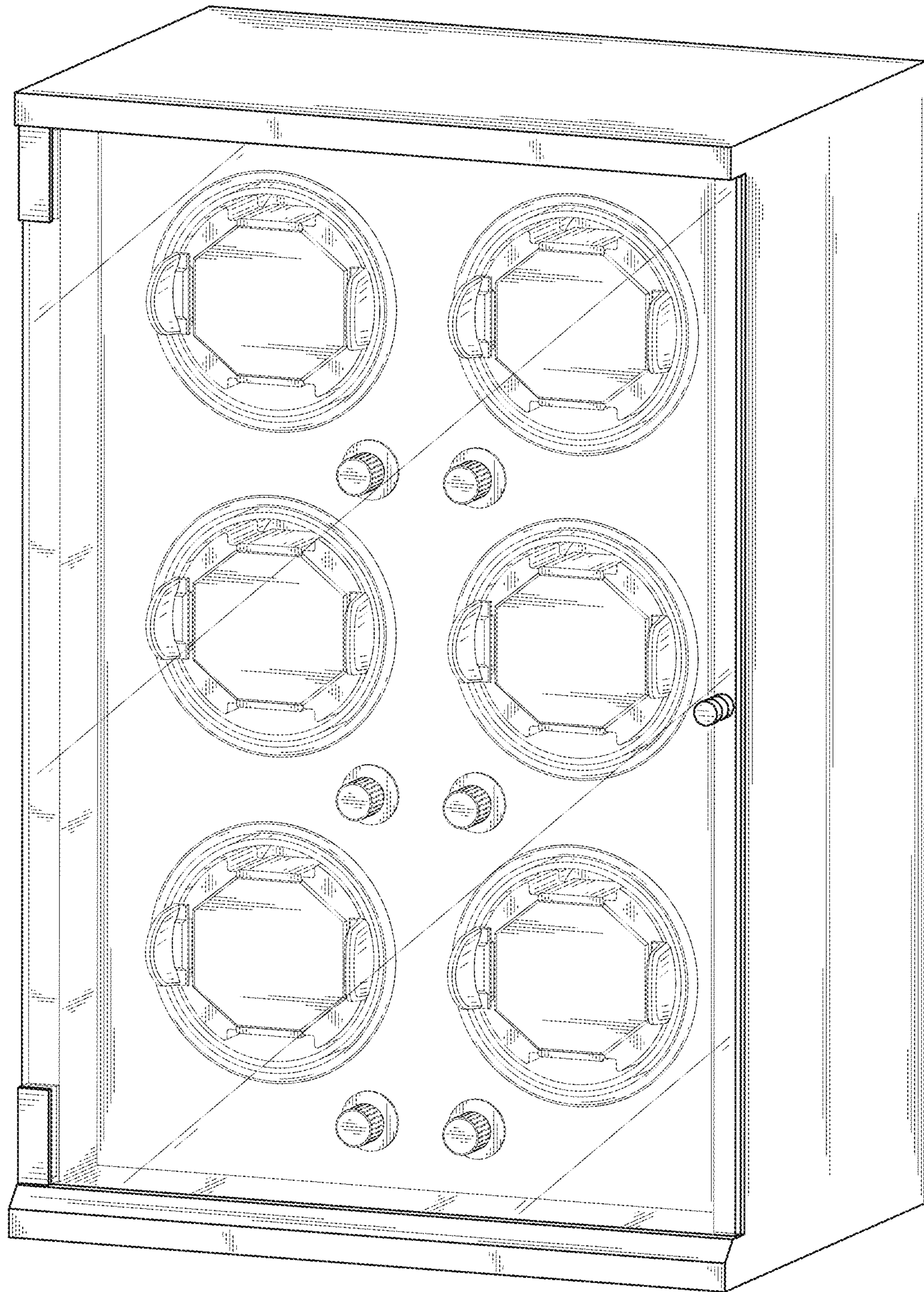

FIG. 9

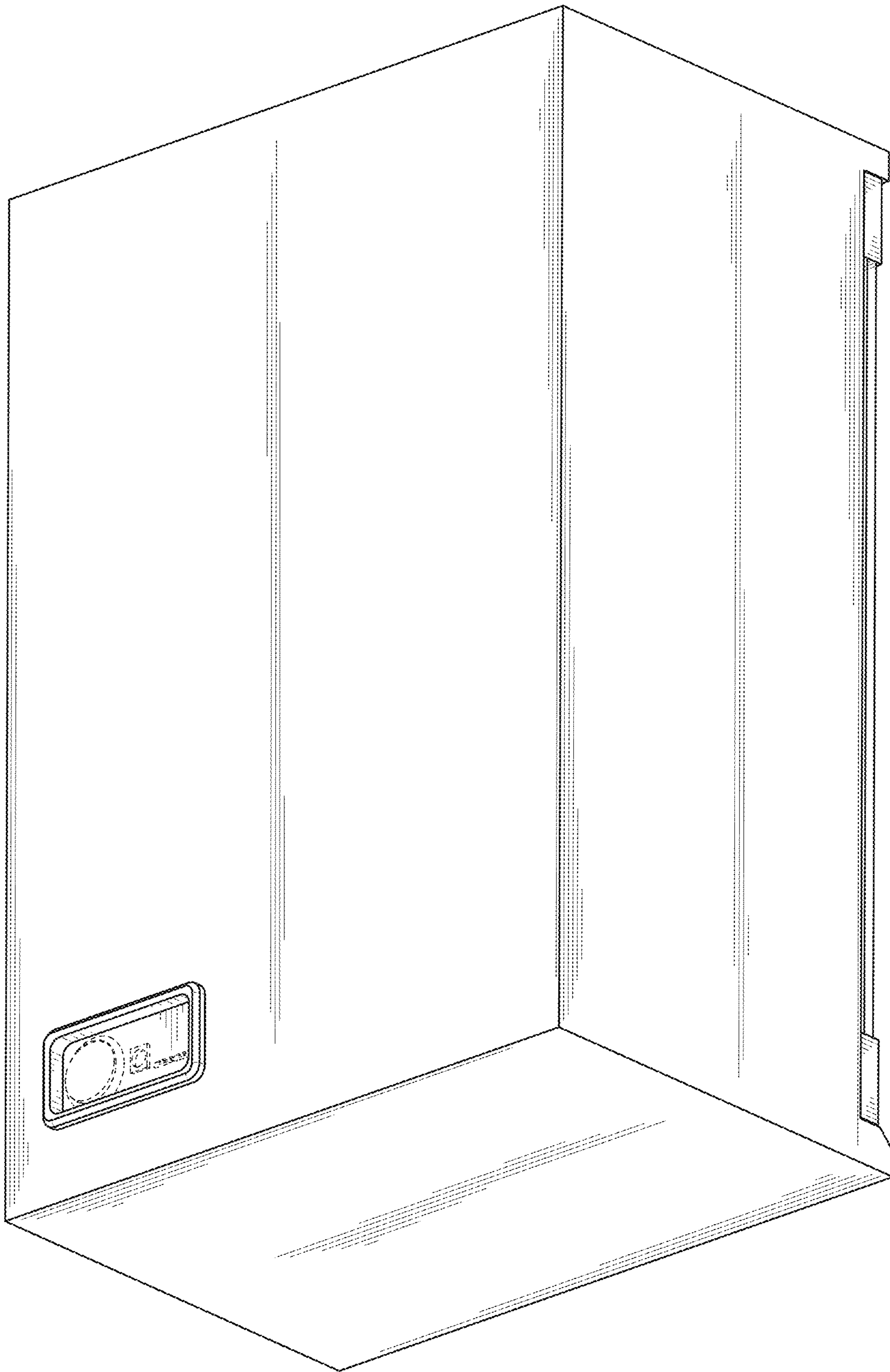

FIG. 10

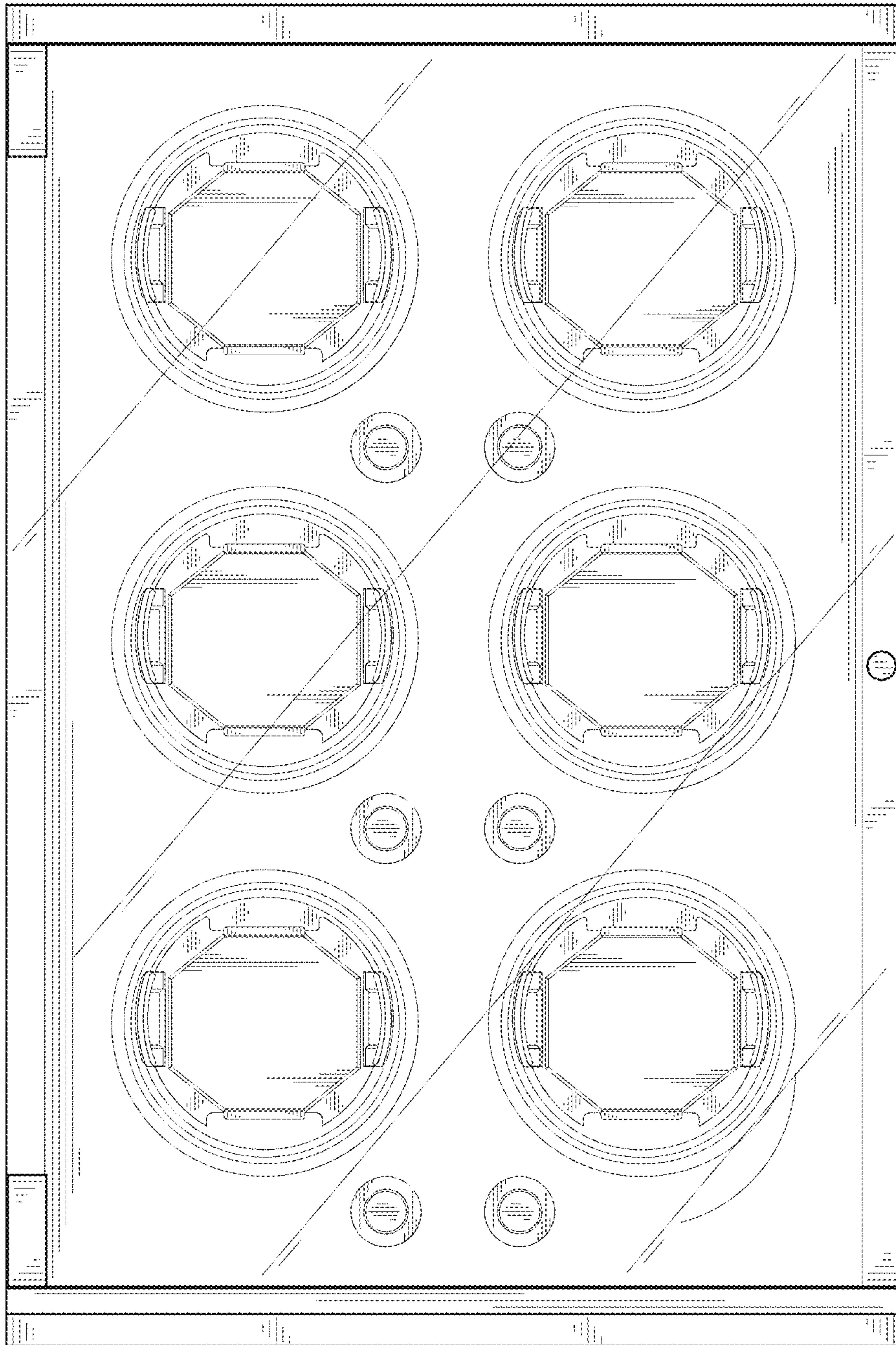

FIG. 11

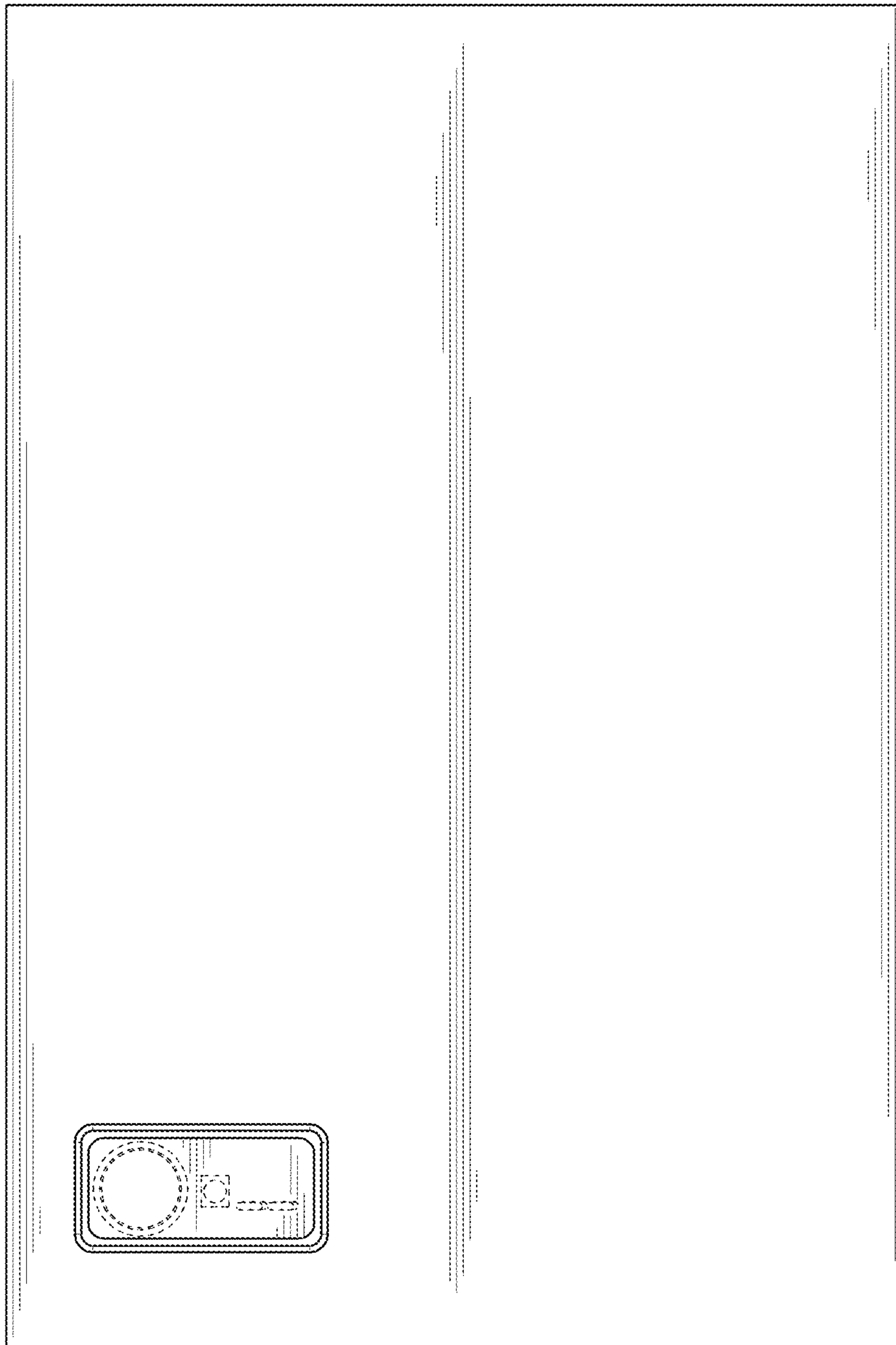

FIG. 12

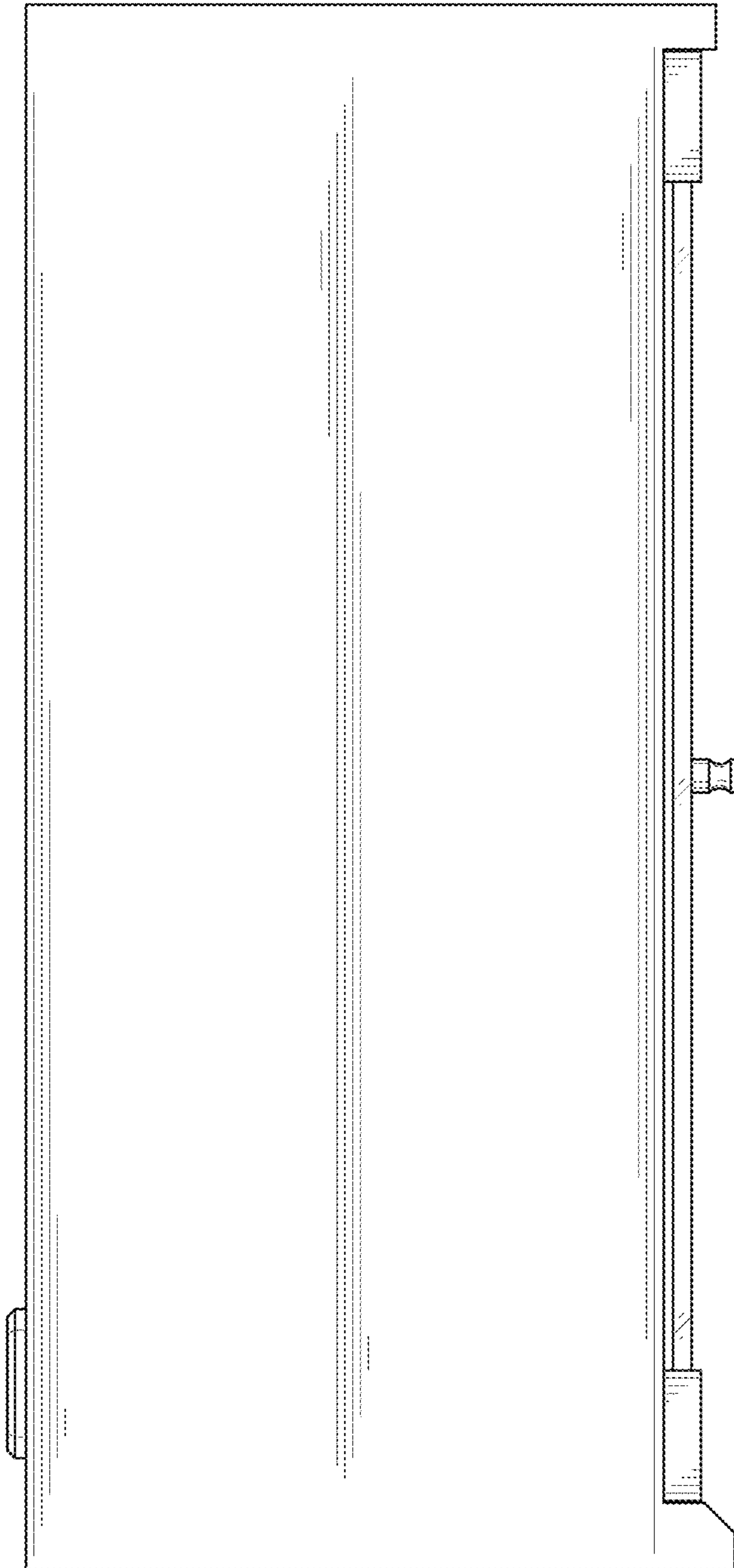

FIG. 13

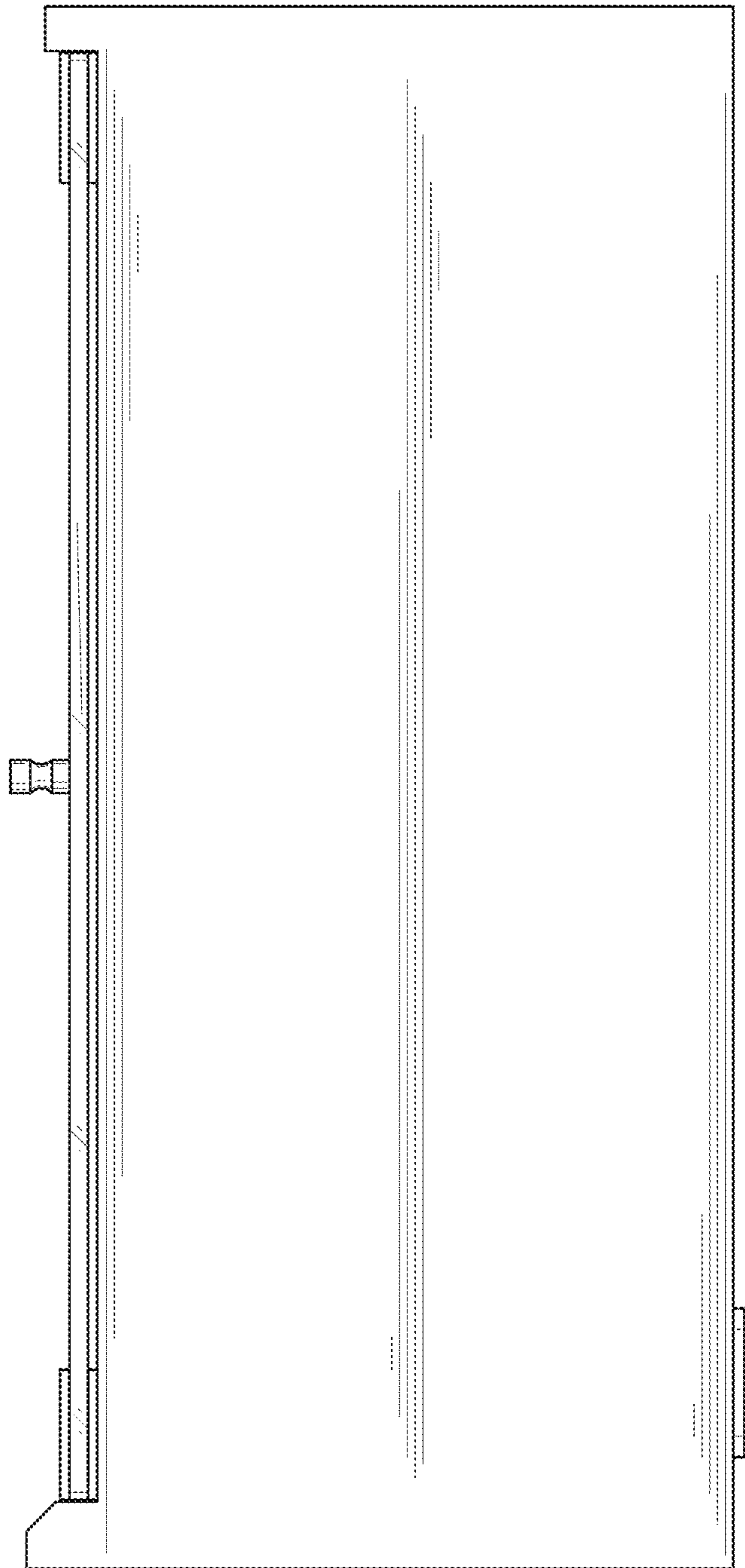

FIG. 14



FIG. 15

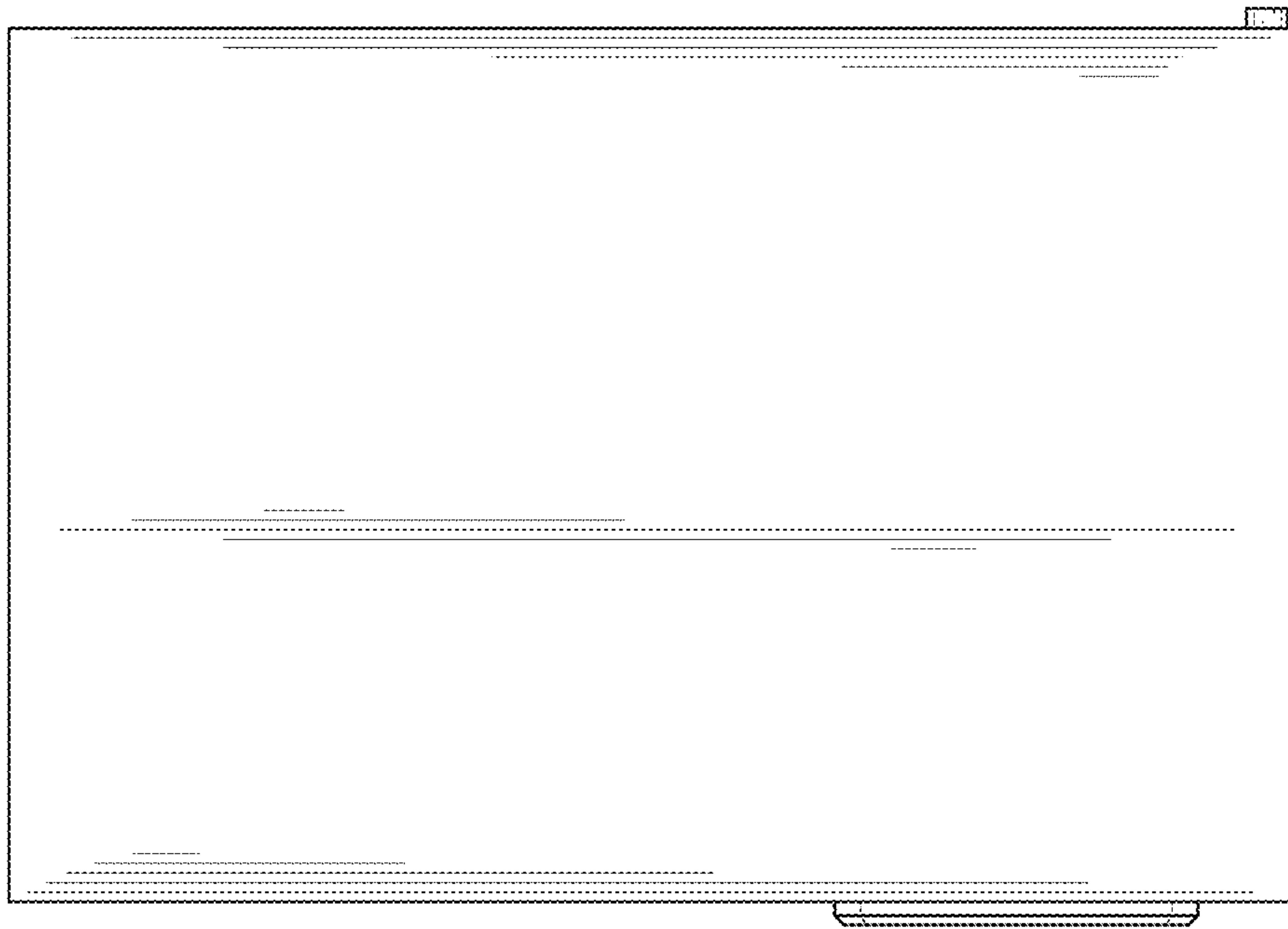

FIG. 16