



US00D976873S

(12) **United States Design Patent**
Wang

(10) **Patent No.:** **US D976,873 S**
(45) **Date of Patent:** **** Jan. 31, 2023**

- (54) **PAIR OF EARPHONES**
- (71) Applicant: **Shenzhen Earfun Technology Co., Ltd., Shenzhen (CN)**
- (72) Inventor: **Zili Wang, Shenzhen (CN)**
- (73) Assignee: **Shenzhen Earfun Technology Co., Ltd., Shenzhen (CN)**

D894,875 S *	9/2020	Zhao	D14/223
D895,582 S *	9/2020	Wu	D14/223
D896,207 S *	9/2020	He	D14/223
D905,018 S *	12/2020	Zhu	D14/223
D907,008 S *	1/2021	Yao	D14/223
D914,646 S *	3/2021	Yang	D14/223
D937,246 S *	11/2021	Li	D14/223
D950,525 S *	5/2022	Chen	D14/223
D957,366 S *	7/2022	Hachiri	D14/223

* cited by examiner

- (**) Term: **15 Years**
- (21) Appl. No.: **29/786,050**
- (22) Filed: **May 28, 2021**

Primary Examiner — Katie Jane Stofko
(74) *Attorney, Agent, or Firm* — ScienBiziP, P.C.

(30) **Foreign Application Priority Data**

Apr. 26, 2021 (CN) 202130244431.3

- (51) **LOC (14) Cl.** **14-01**
- (52) **U.S. Cl.**
USPC **D14/223**

- (58) **Field of Classification Search**
USPC D14/223, 205, 206; D24/174, 217, 218;
128/864, 865, 866; 181/129, 130, 135;
379/430, 431; 381/380, 381, 322-324,
381/330; 455/90.3, 575, 1, 569.1;
D9/415, 432, 721; D3/274, 294;
D13/108
CPC H04R 1/10; H04R 25/00; H04R 1/1016;
H04R 1/1066; H04R 5/033; H04R
5/0335; H04R 1/1091; H04R 1/1058;
H04R 1/105; H04R 1/1083

See application file for complete search history.

(56) **References Cited**

U.S. PATENT DOCUMENTS

D847,794 S *	5/2019	Guo	D14/223
D860,976 S *	9/2019	Zhang	D14/223
D887,396 S *	6/2020	Wang	D14/223
D890,138 S *	7/2020	Peng	D14/223

(57) **CLAIM**

The ornamental design for a pair of earphones, as shown and described.

DESCRIPTION

FIG. 1 is a front perspective view of a right earphone of a pair of earphones showing my design;
 FIG. 2 is a rear perspective view thereof;
 FIG. 3 is a front elevation view thereof;
 FIG. 4 is a rear elevation view thereof;
 FIG. 5 is a left side elevation view thereof;
 FIG. 6 is a right side elevation view thereof
 FIG. 7 is a top plan view thereof;
 FIG. 8 is a bottom plan view thereof;
 FIG. 9 is a front perspective view of a left earphone of a pair of earphones showing my design;
 FIG. 10 is a rear perspective view thereof;
 FIG. 11 is a front elevation view thereof;
 FIG. 12 is a rear elevation view thereof;
 FIG. 13 is a left side elevation view thereof;
 FIG. 14 is a right side elevation view thereof;
 FIG. 15 is a top plan view thereof; and,
 FIG. 16 is a bottom plan view thereof.

The broken lines in the drawings are employed to show unclaimed portions of the pair of earphones, and form no part of the claimed design.

1 Claim, 16 Drawing Sheets

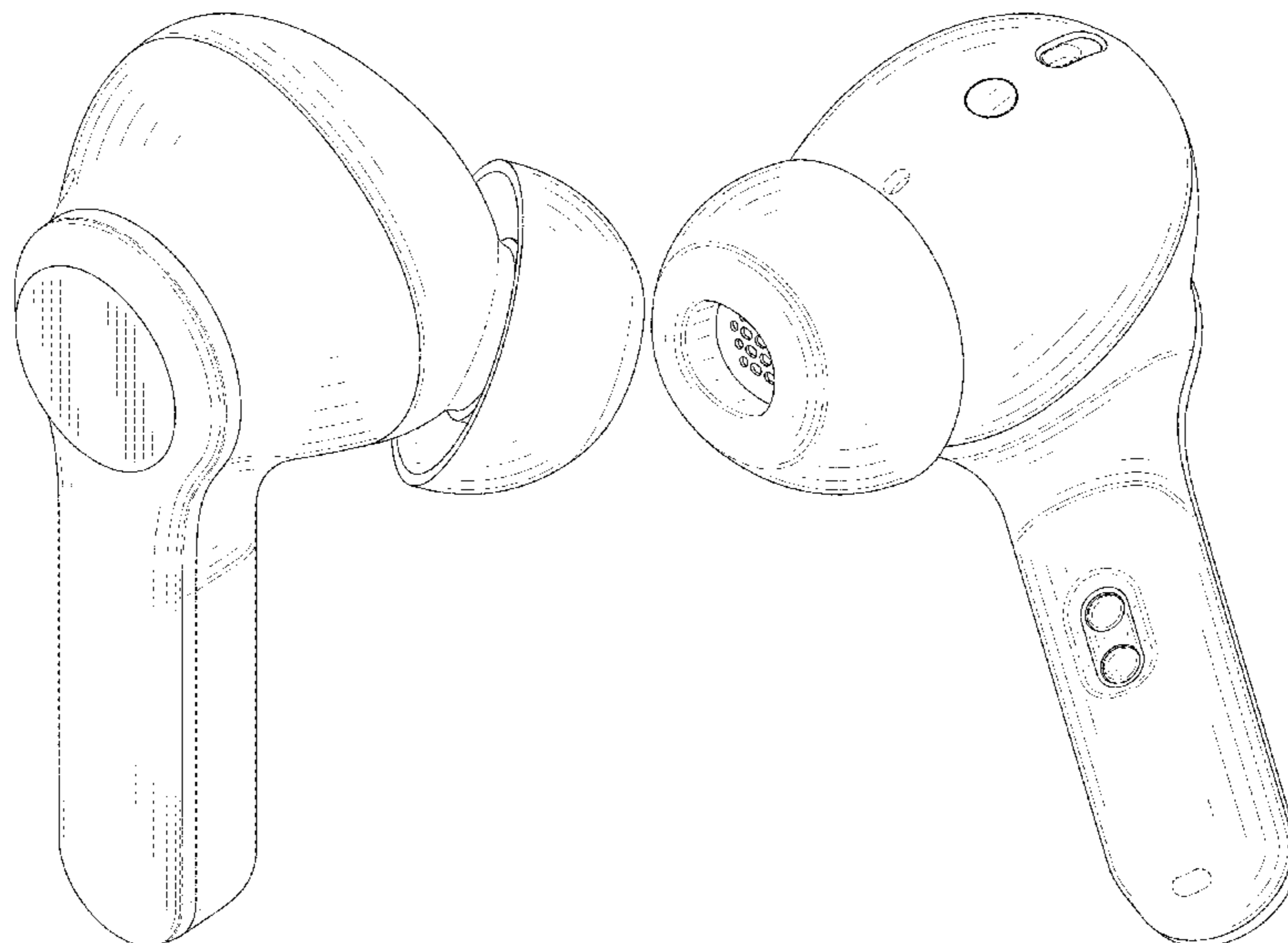

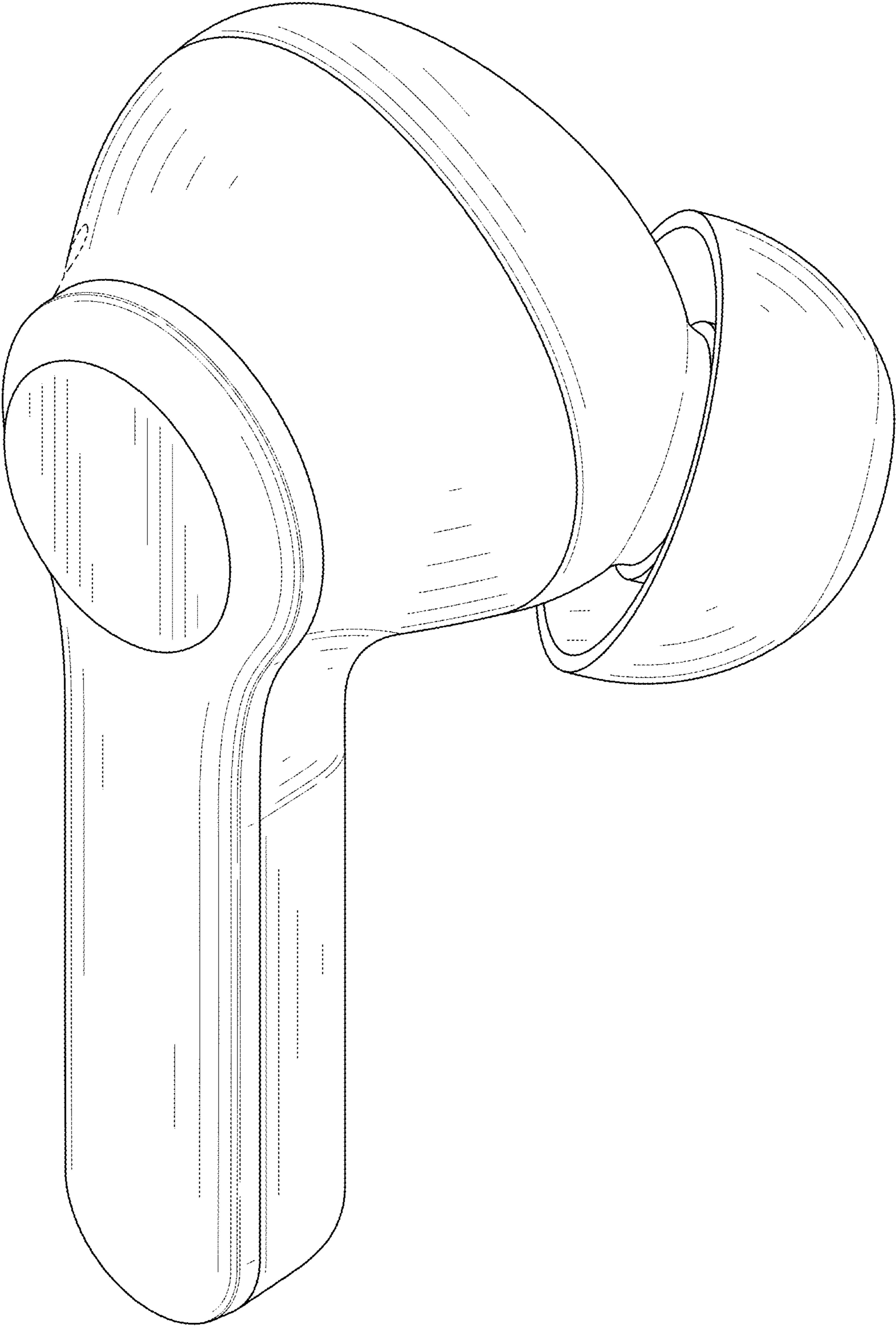

FIG. 1

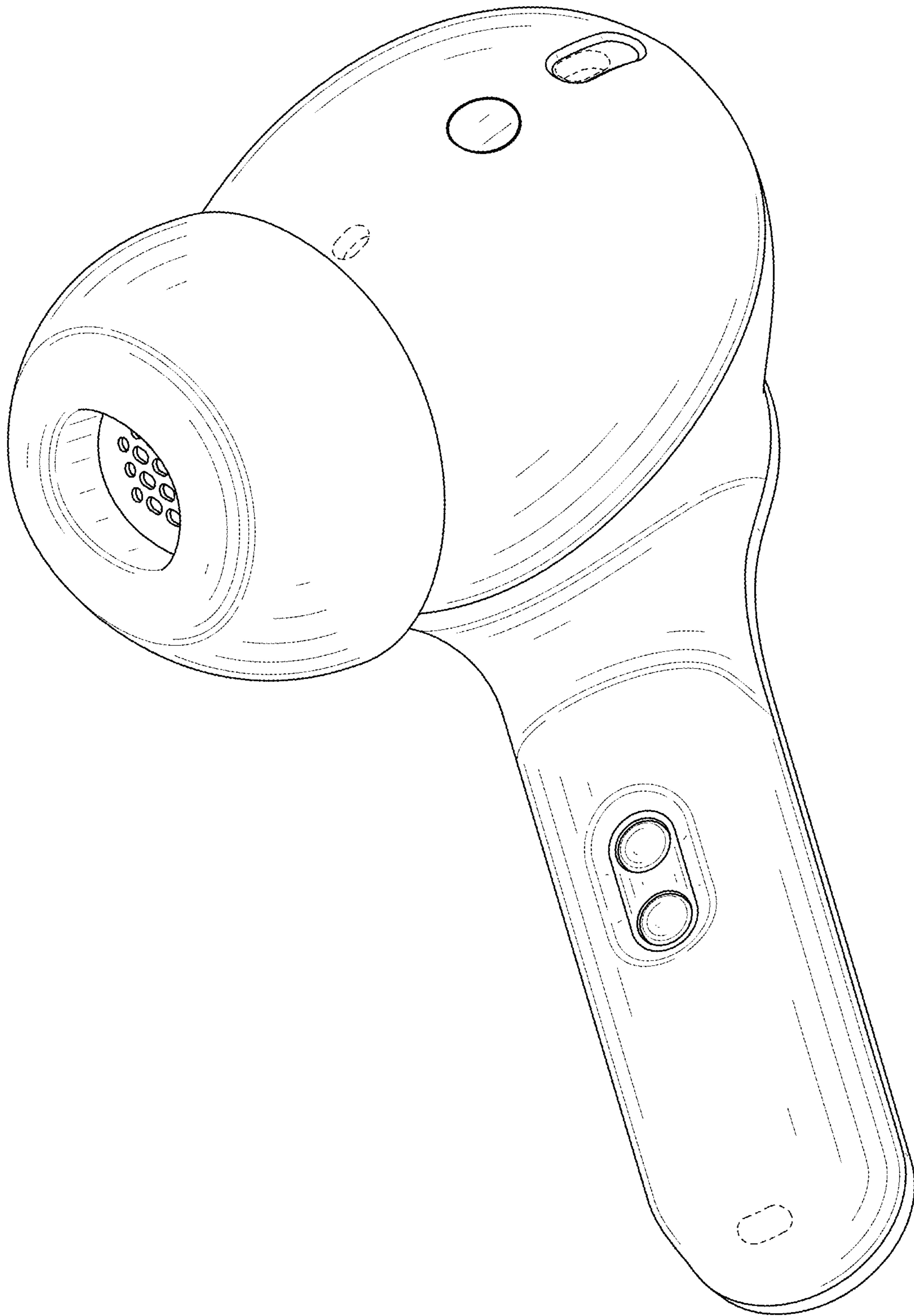

FIG. 2

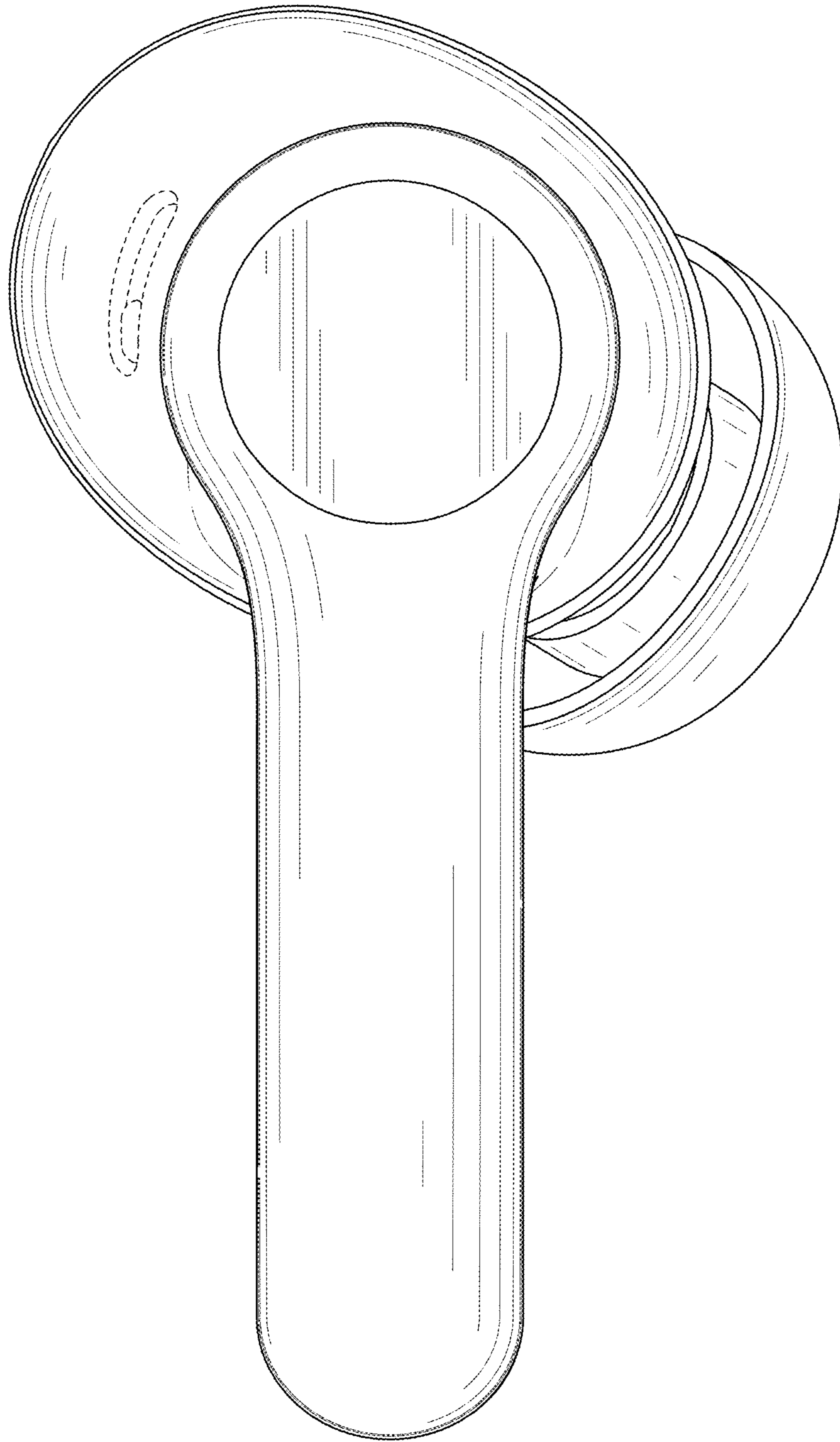

FIG. 3

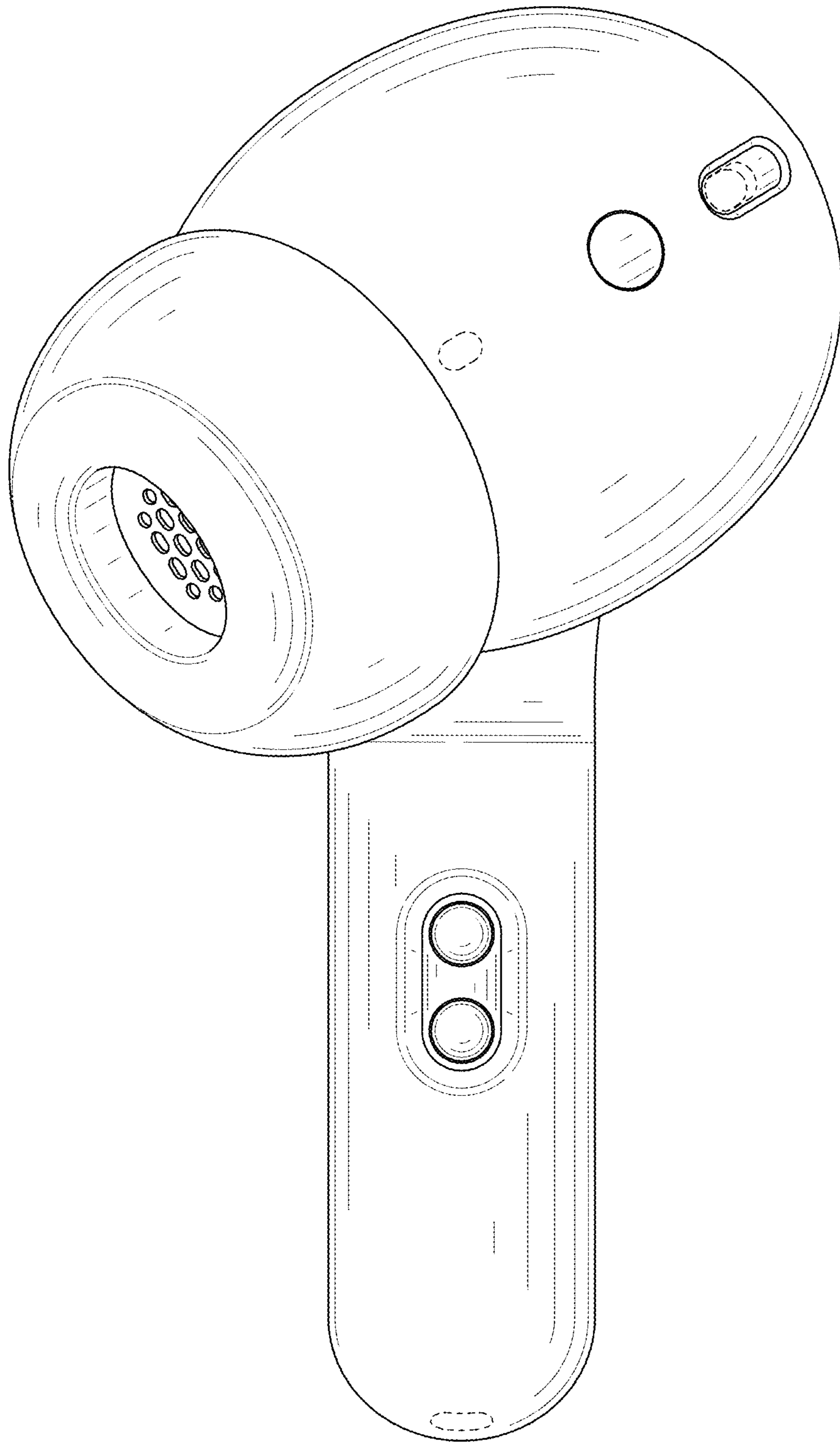

FIG. 4

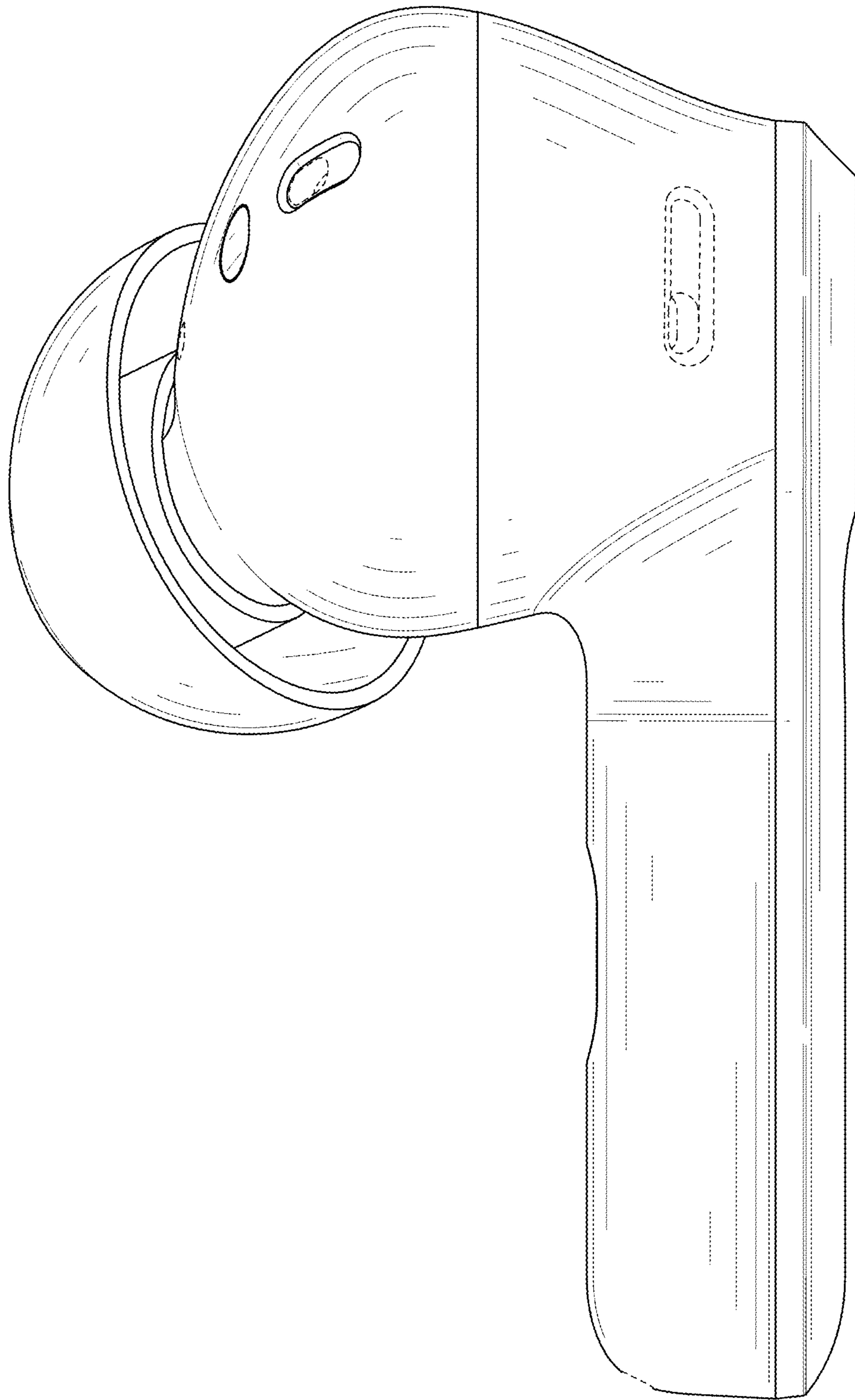

FIG. 5

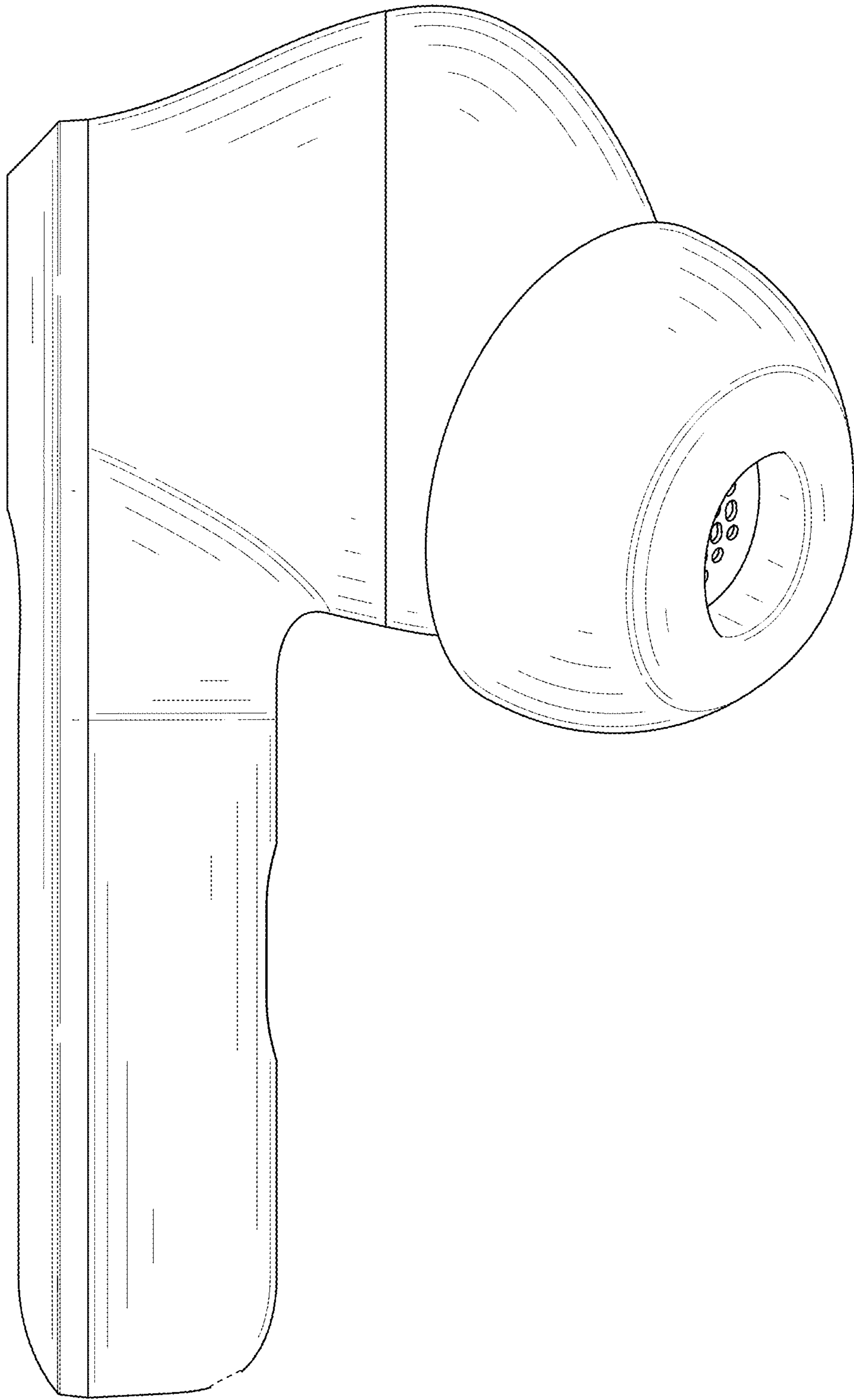

FIG. 6

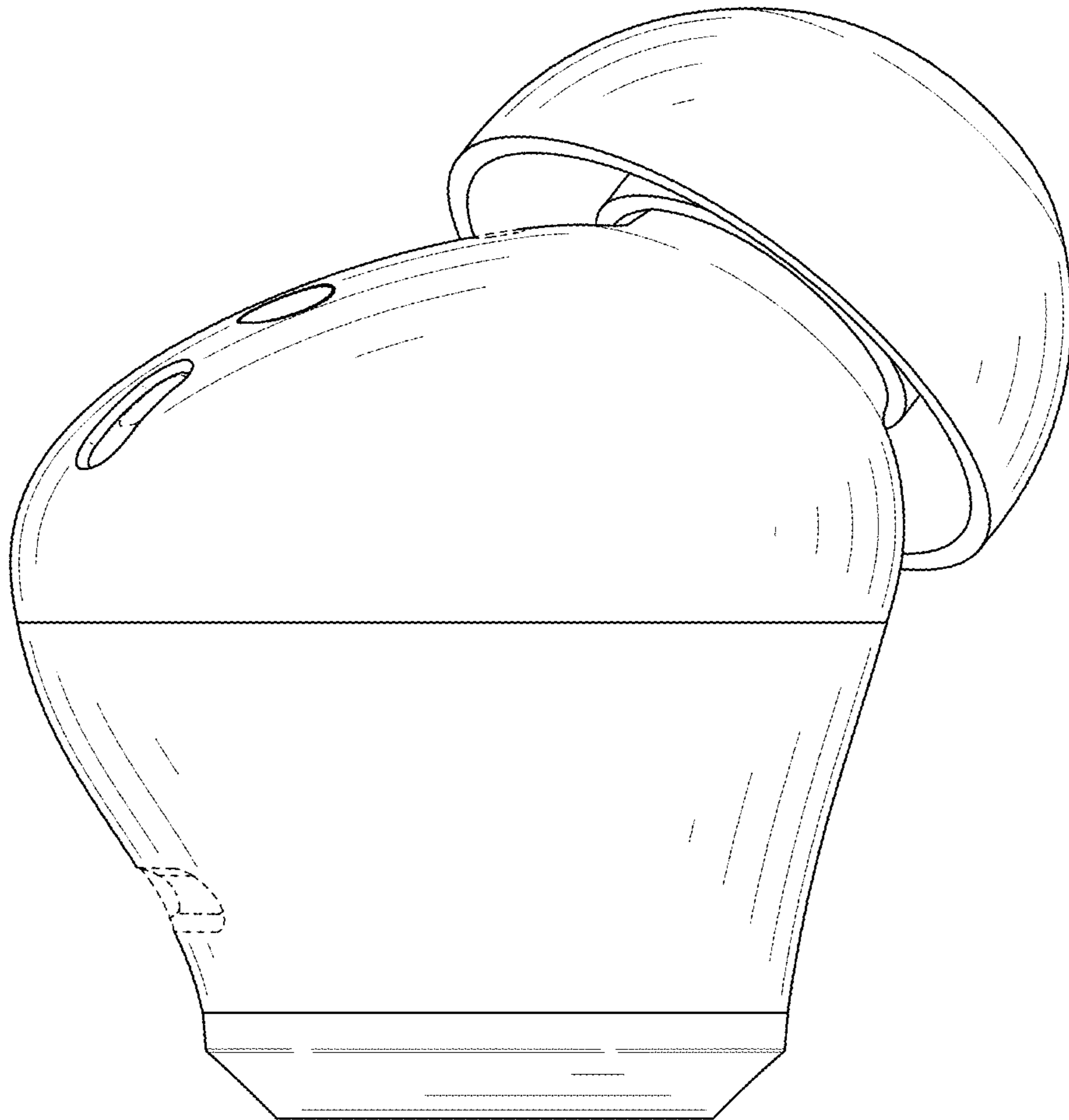

FIG. 7

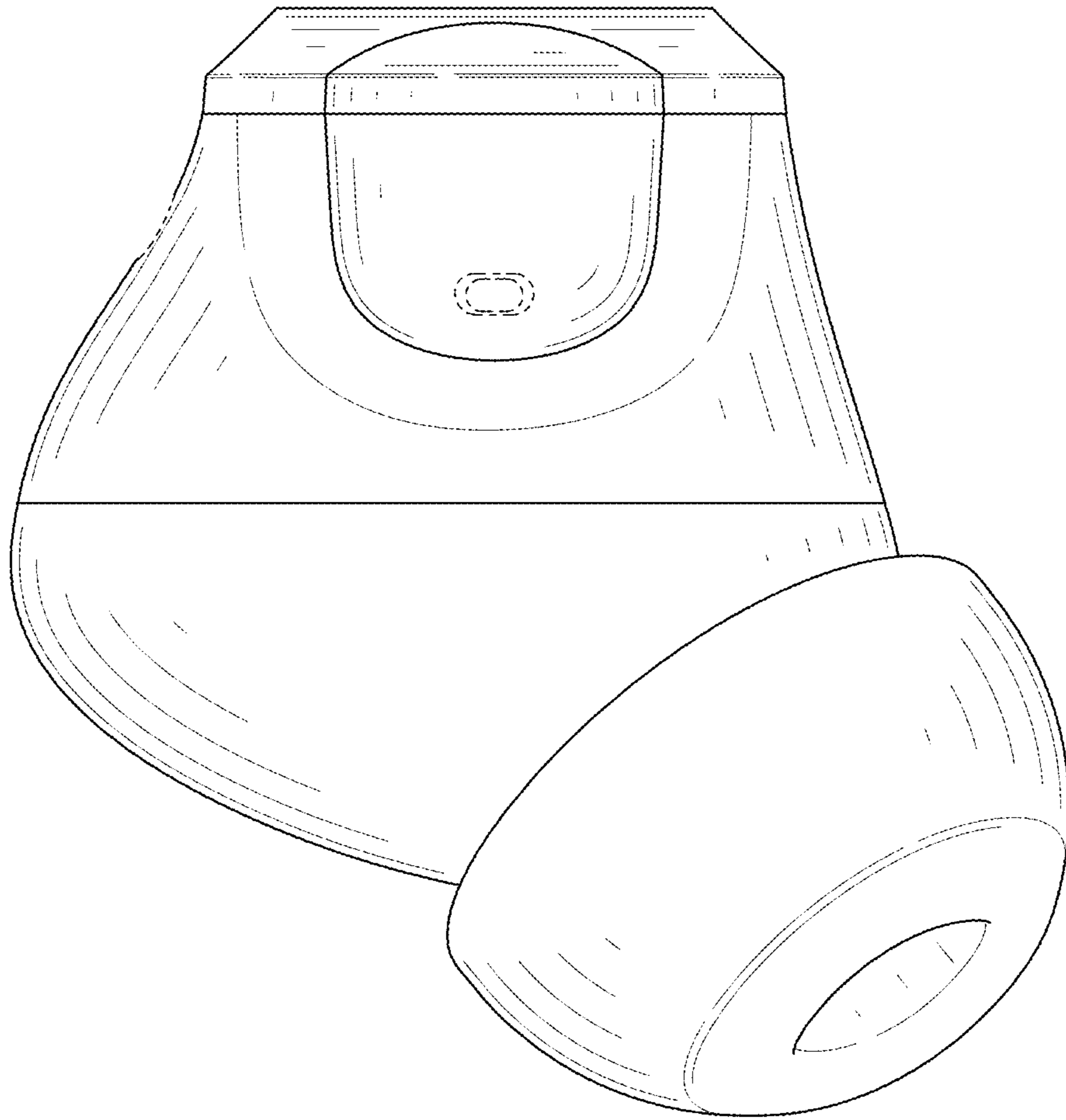

FIG. 8

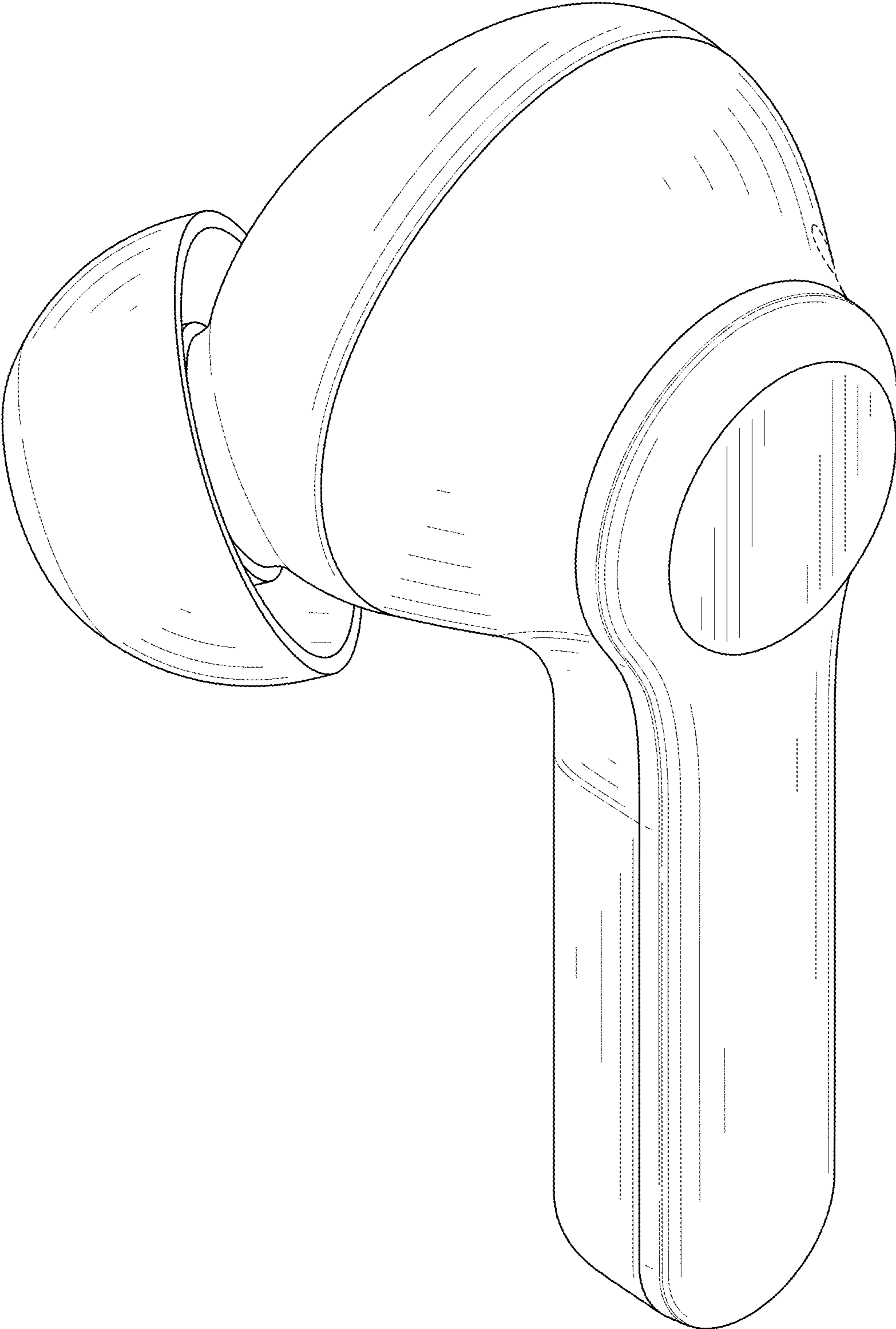

FIG. 9

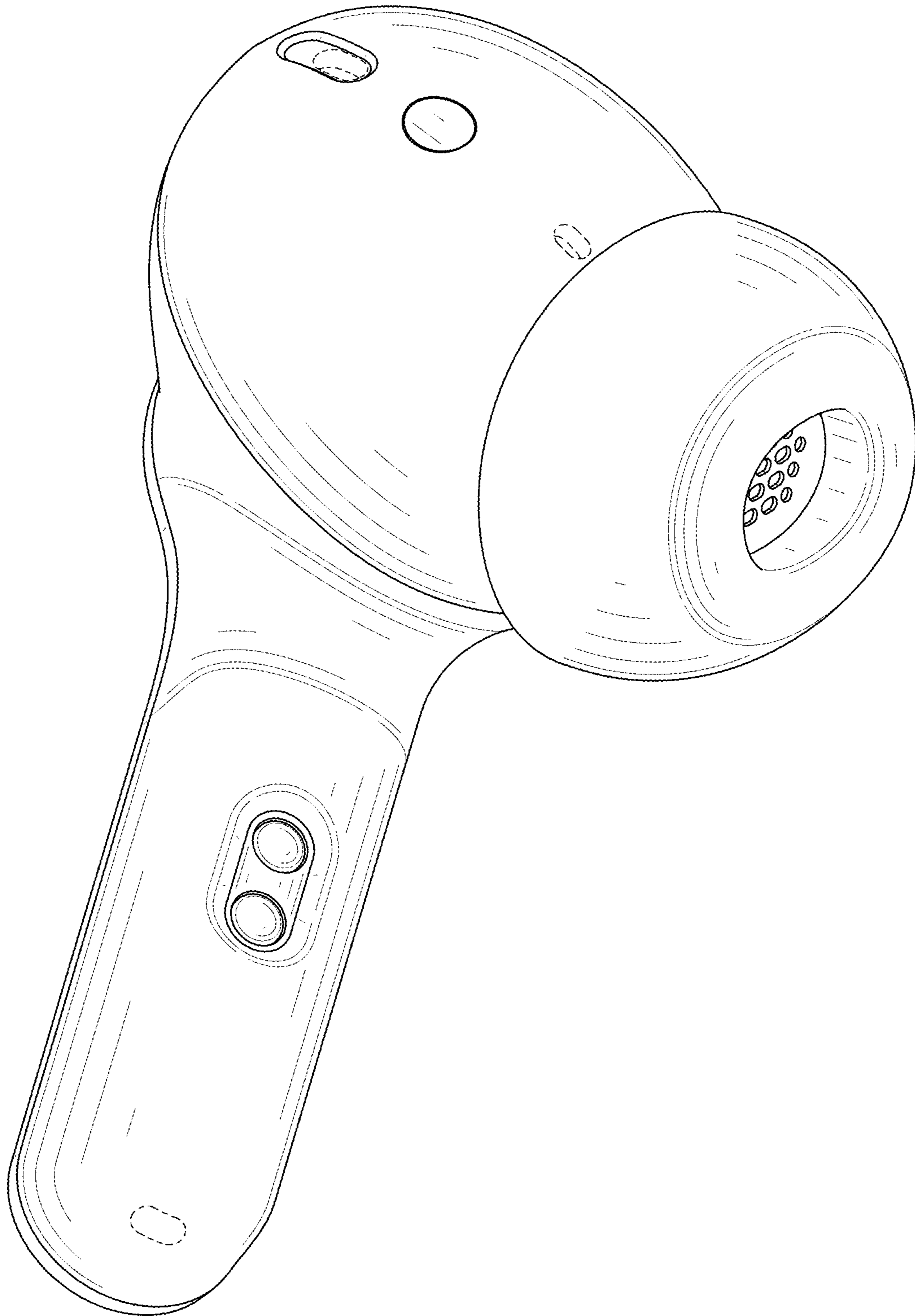

FIG. 10

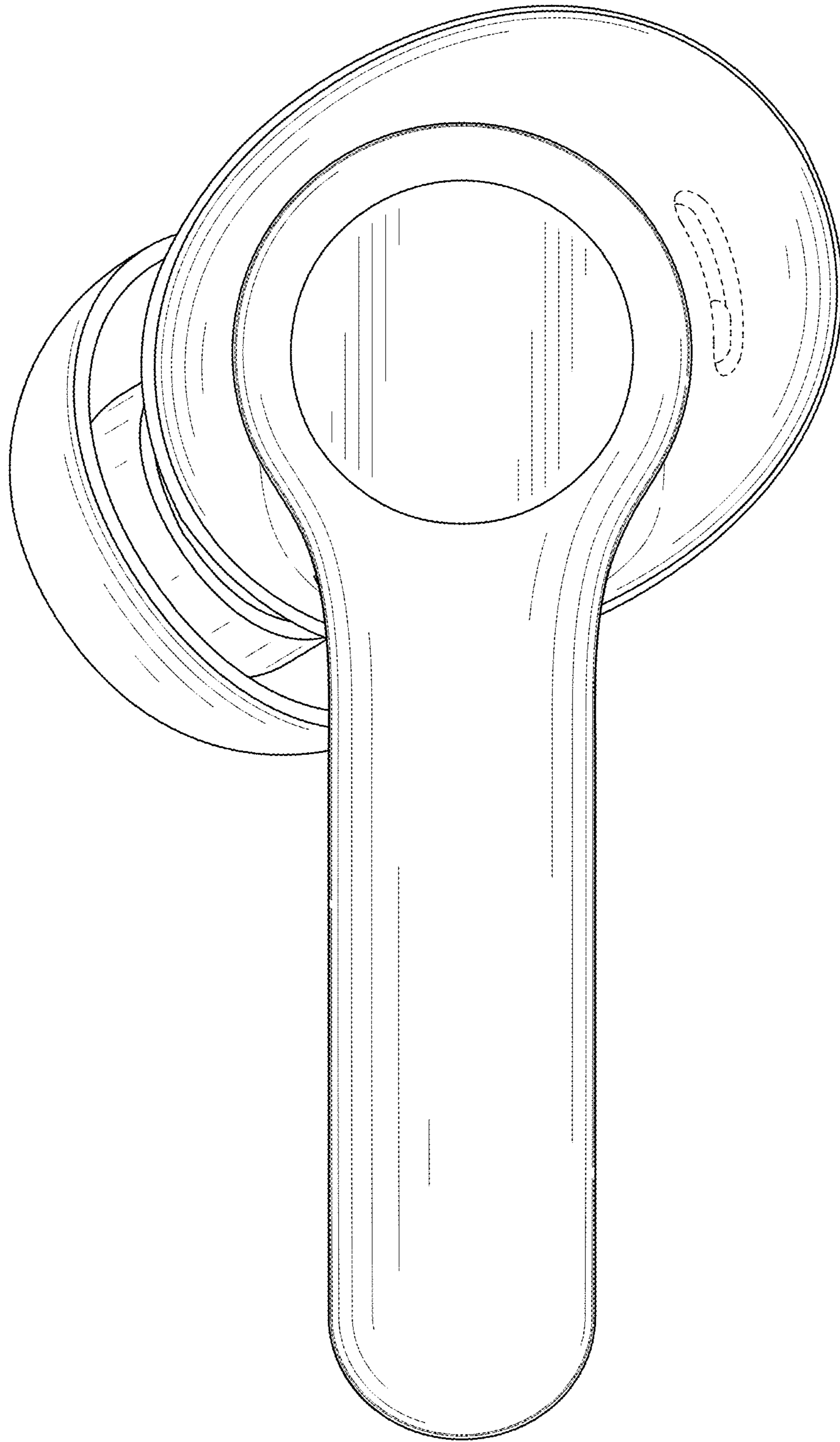

FIG. 11

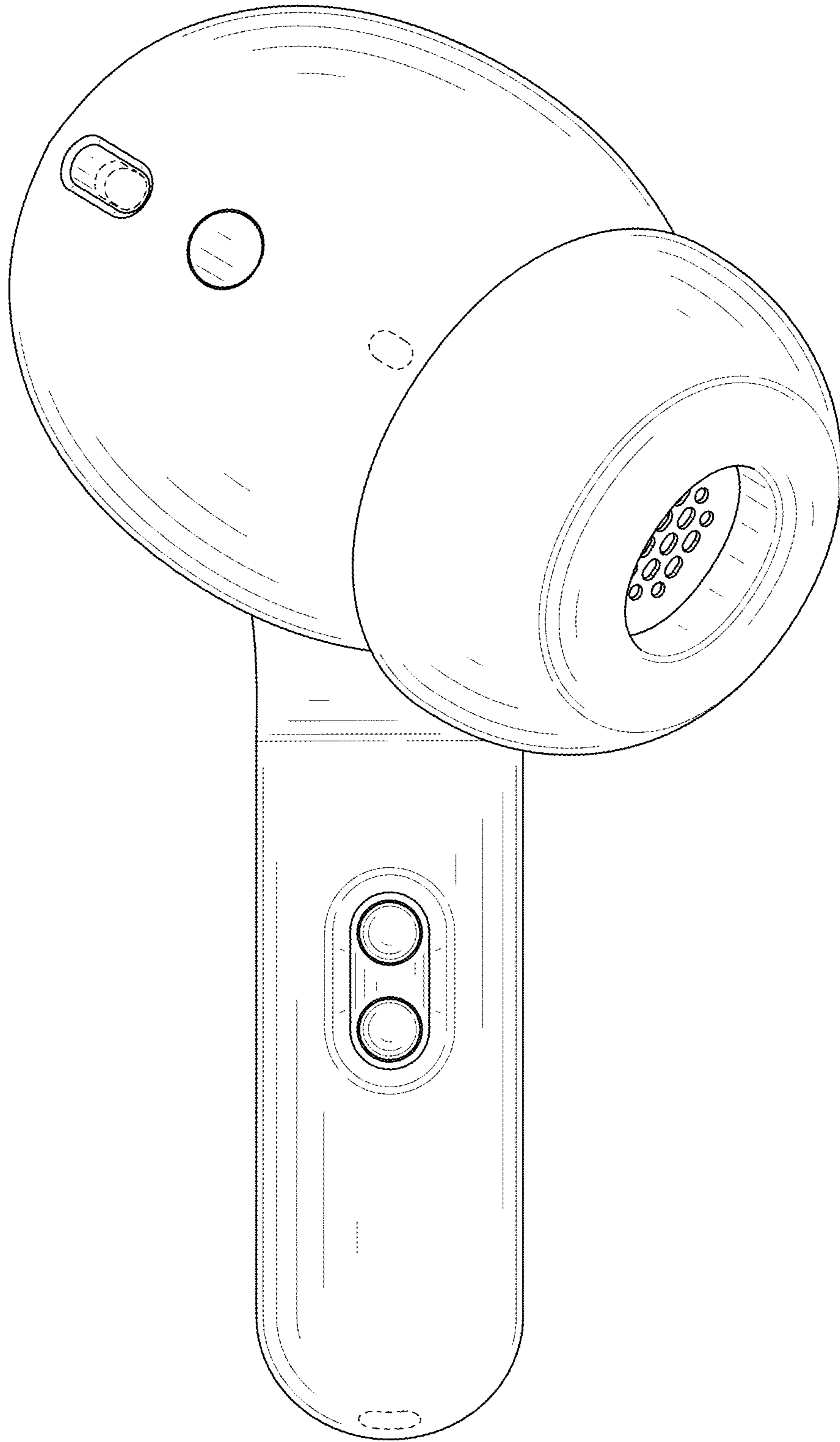

FIG. 12

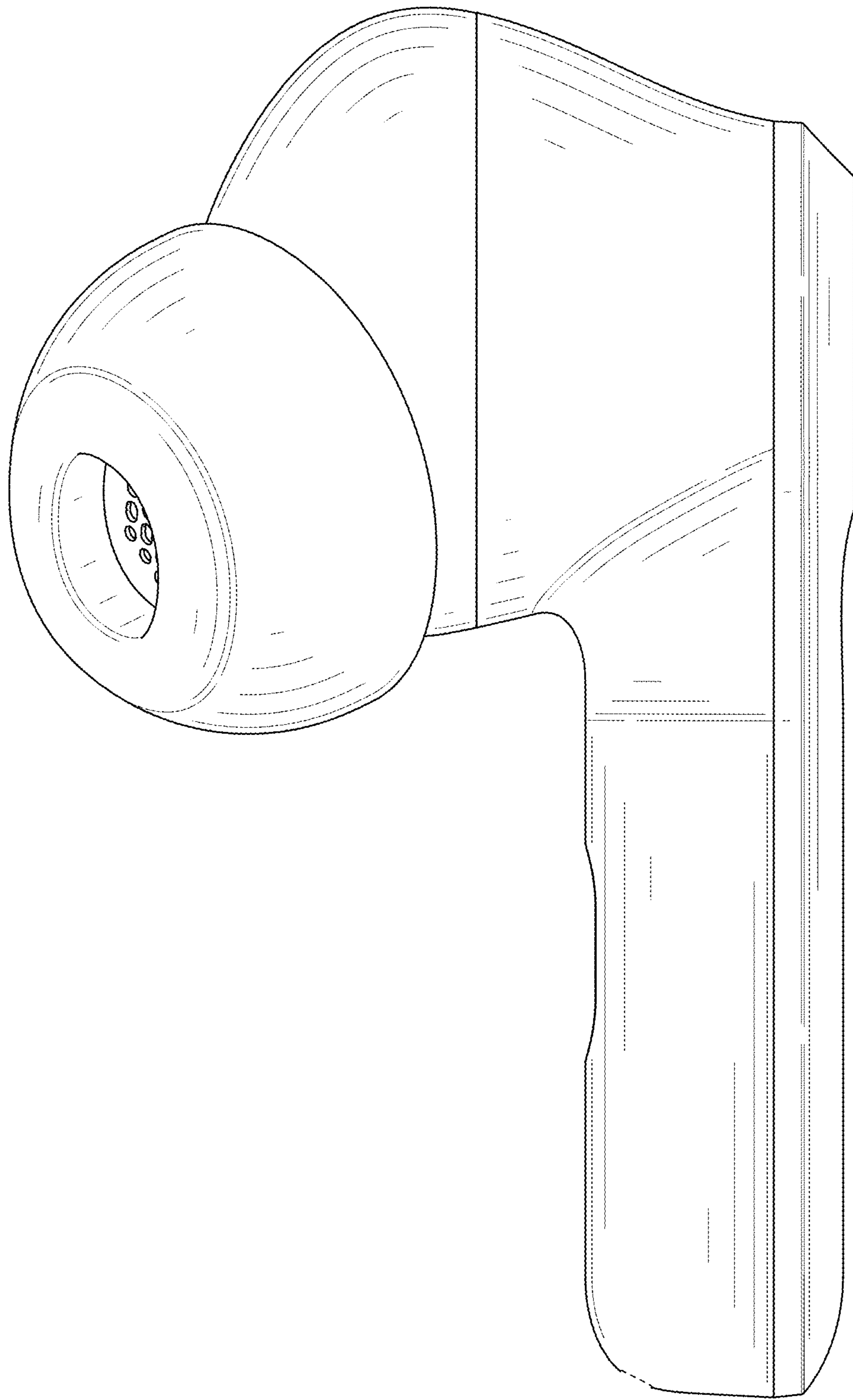

FIG. 13

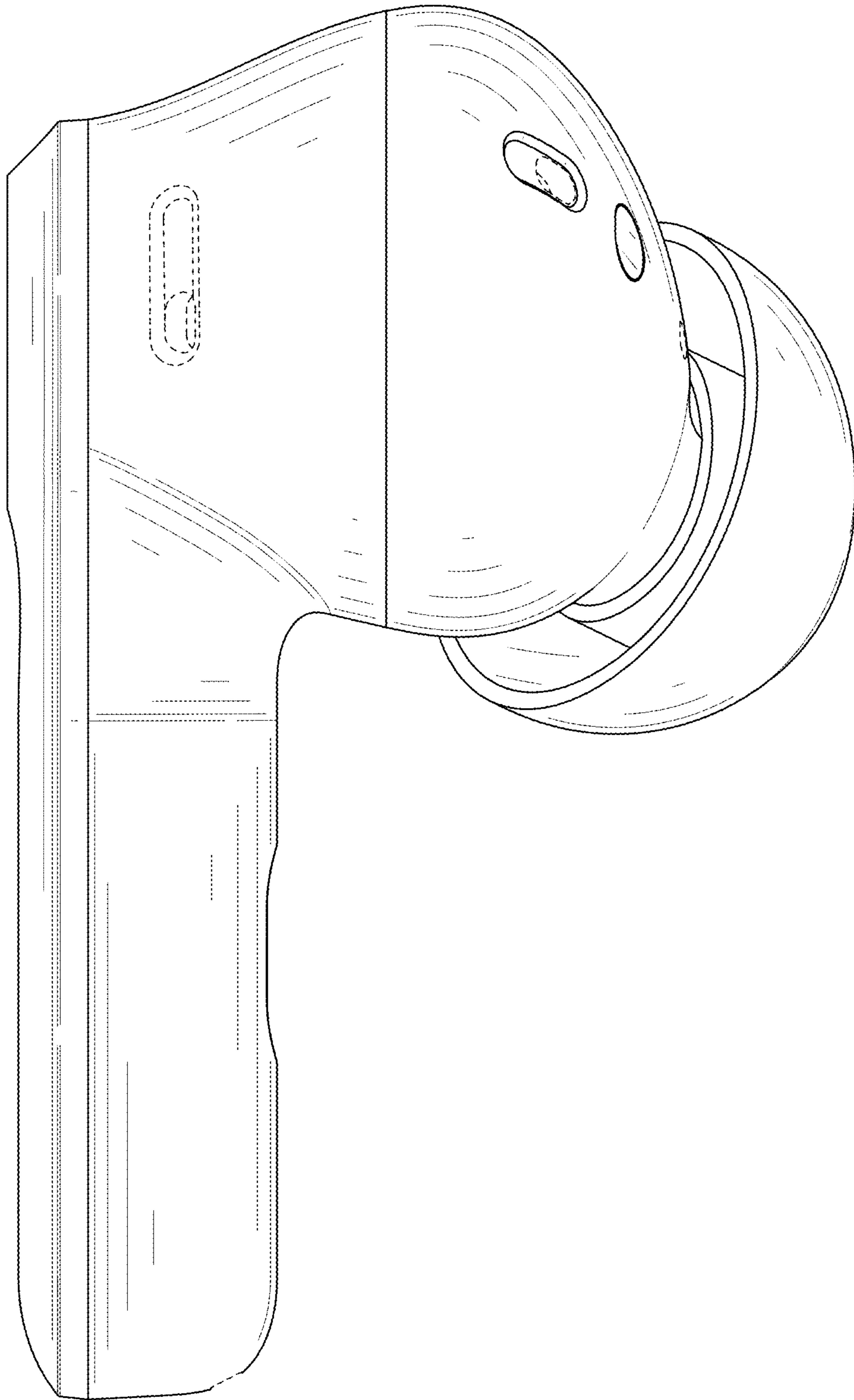

FIG. 14

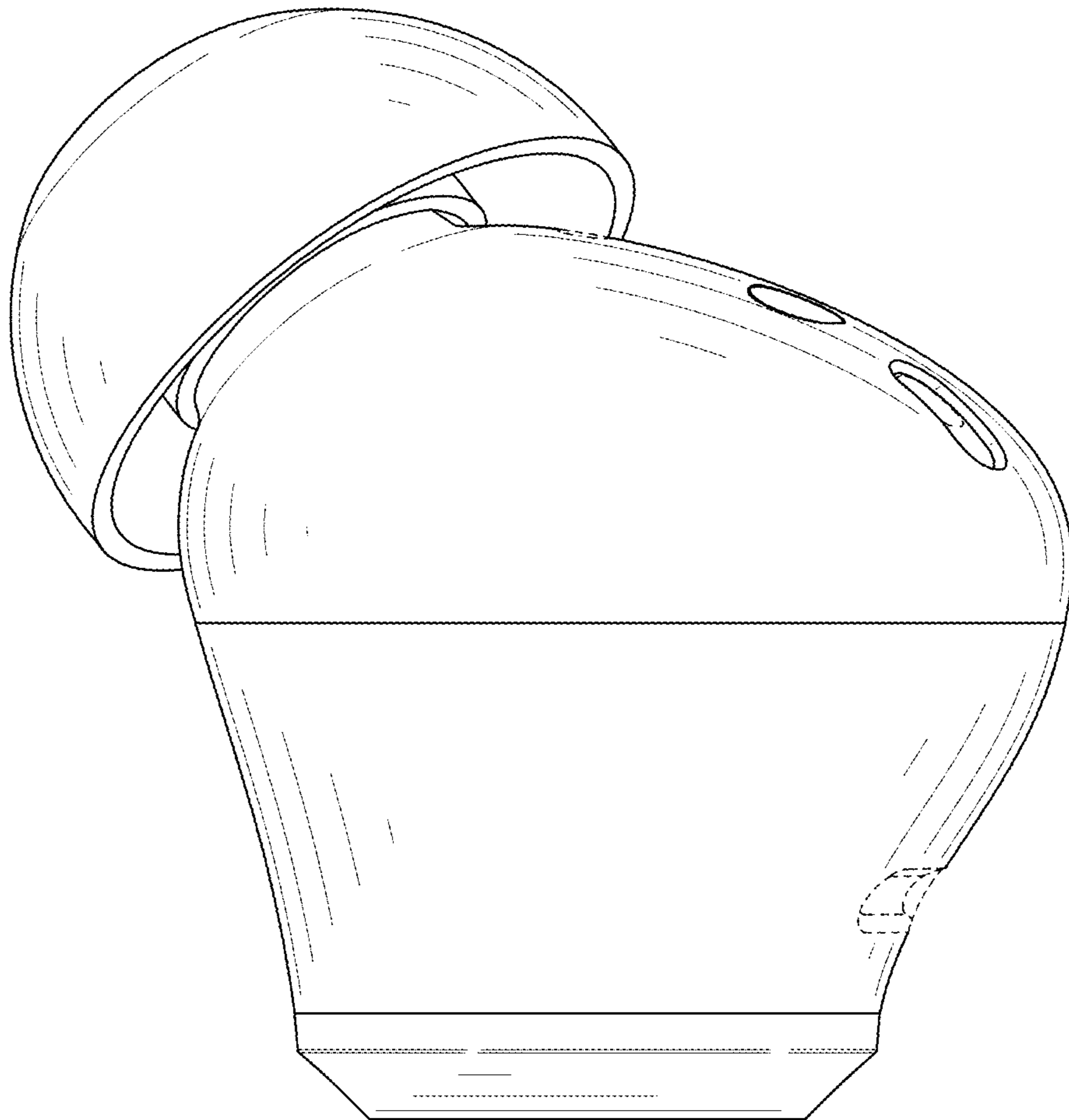

FIG. 15

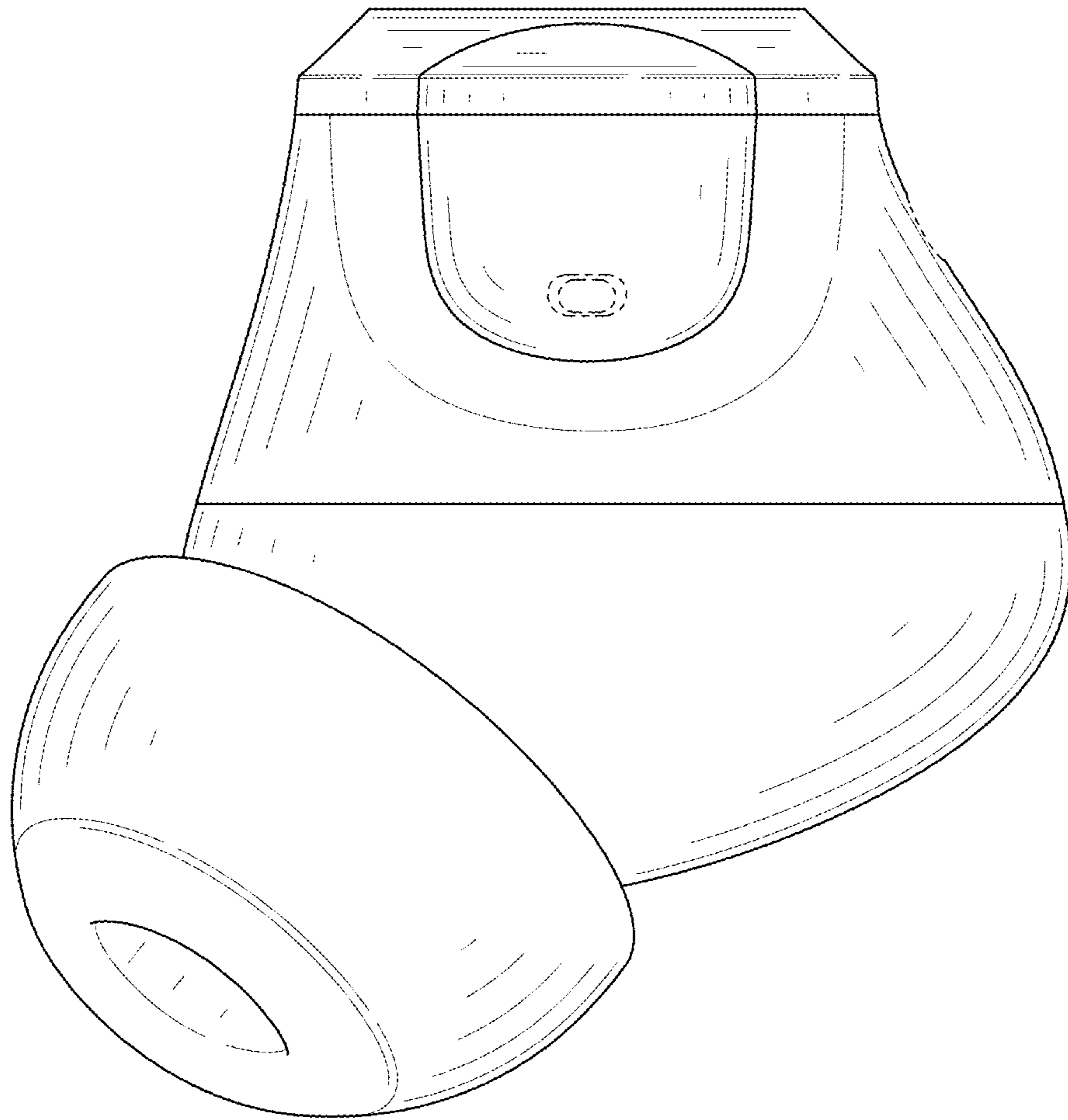

FIG. 16