



US00D976648S

(12) **United States Design Patent** (10) **Patent No.:** **US D976,648 S**
Rogers et al. (45) **Date of Patent:** **** Jan. 31, 2023**

(54) **CUTTER HEAD FOR CUTTING FOOD PRODUCTS**

(71) Applicant: **McCain Foods Limited**,
Florenceville-Bristol (CA)

(72) Inventors: **David M. Rogers**, Skiff Lake (CA);
John Warren Aikens, New Maryland (CA)

(73) Assignee: **McCain Foods Limited**,
Florenceville-Bristol (CA)

(**) Term: **15 Years**

(21) Appl. No.: **29/777,438**

(22) Filed: **Apr. 6, 2021**

(51) **LOC (14) Cl.** **31-00**

(52) **U.S. Cl.**
USPC **D7/412**

(58) **Field of Classification Search**
USPC D1/120, 125, 199; D7/368, 372,
D7/376-387, 400, 412-13, 669, 673,
D7/675-679, 665, 667; D8/98
(Continued)

(56) **References Cited**

U.S. PATENT DOCUMENTS

4,657,255 A 4/1987 Seres
5,293,803 A 3/1994 Foster
(Continued)

FOREIGN PATENT DOCUMENTS

CA 187480 10/2020
CA 187481 10/2020
(Continued)

Primary Examiner — Nicole C Shiflet
Assistant Examiner — Yen Le Southwood

(74) *Attorney, Agent, or Firm* — Bereskin & Parr
LLP/S.E.N.C.R.L., s.r.l.

(57) **CLAIM**

The ornamental design for a cutter head for cutting food products, as shown and described.

DESCRIPTION

FIG. 1 is a top perspective view of a cutter head for cutting food products showing our new design, in accordance with a first embodiment;
FIG. 2 is a bottom perspective view thereof;
FIG. 3 is a front elevation view thereof;
FIG. 4 is a rear elevation view thereof;
FIG. 5 is a left side elevation view thereof;
FIG. 6 is a right side elevation view thereof;
FIG. 7 is a top plan view thereof;
FIG. 8 is a bottom plan view thereof;
FIG. 9 is a top perspective view of a cutter head for cutting food products showing our new design, in accordance with a second embodiment;
FIG. 10 is a bottom perspective view thereof;
FIG. 11 is a front elevation view thereof;
FIG. 12 is a rear elevation view thereof;
FIG. 13 is a left side elevation view thereof;
FIG. 14 is a right side elevation view thereof;
FIG. 15 is a top plan view thereof;
FIG. 16 is a bottom plan view thereof;
FIG. 17 is a top perspective view of a cutter head for cutting food products showing our new design, in accordance with a third embodiment;
FIG. 18 is a bottom perspective view thereof;
FIG. 19 is a front elevation view thereof;
FIG. 20 is a rear elevation view thereof;
FIG. 21 is a left side elevation view thereof;
FIG. 22 is a right side elevation view thereof;
FIG. 23 is a top plan view thereof; and,
FIG. 24 is a bottom plan view thereof.
Portions of the cutter head for cutting food products illustrated in broken lines form no part of the claimed design.

1 Claim, 12 Drawing Sheets

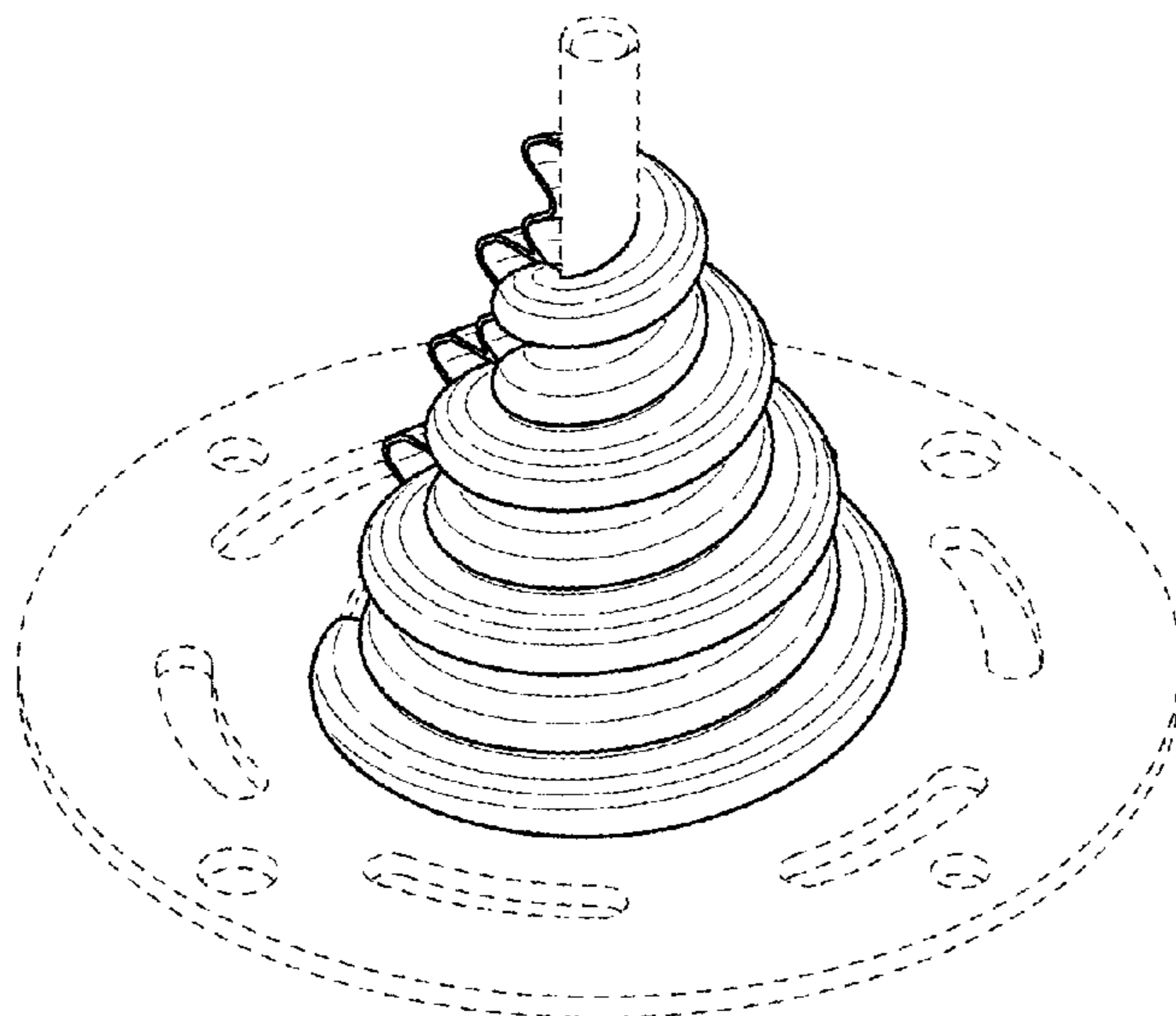

(58) **Field of Classification Search**

CPC .. A47J 17/02; A47J 25/00; A47J 42/00; A47J 43/04; A47J 43/06; A47J 43/07; A47J 43/0722; A47J 43/0727; A47J 43/255; A47J 43/284; B65D 71/00; B26D 3/11
See application file for complete search history.

FOREIGN PATENT DOCUMENTS

(56) **References Cited**

U.S. PATENT DOCUMENTS

D603,133	S	*	11/2009	Schalk	D1/199
D621,578	S	*	8/2010	Farkas	D1/199
D712,618	S	*	9/2014	Rogers	D1/125
D745,244	S	*	12/2015	Rogers	D1/199
D745,245	S	*	12/2015	Rogers	D1/199
D813,491	S		3/2018	Walker		
D894,681	S		9/2020	Julian		
D894,682	S		9/2020	Julian		
D895,358	S		9/2020	Julian		
D895,359	S		9/2020	Julian		
D895,360	S		9/2020	Monk et al.		
D896,033	S		9/2020	Monk et al.		
D901,828	S	*	11/2020	Monk	D1/125
D922,142	S	*	6/2021	Monk	D7/381
D922,143	S	*	6/2021	Monk	D7/381
D922,822	S		6/2021	Monk et al.		
D922,823	S		6/2021	Monk et al.		
D942,116	S	*	2/2022	Abboushi	D1/101
2015/0119861	A1	*	4/2015	Miyata	A61M 25/09 604/528
2018/0222075	A1		8/2018	Julian et al.		
2018/0222076	A1		8/2018	Julian et al.		
2020/0147824	A1		5/2020	Julian et al.		

CA	187482	10/2020
CA	187483	10/2020
CA	191632 S	11/2021
CA	196192 S	11/2021
CA	196281 S	11/2021
CN	306201139 S	1/2020
CN	306031421 S	4/2020
CN	306271707 S	1/2021
CN	306362558 S	3/2021
CN	306407377 S	3/2021
EM	006438297-0001	6/2019
EM	006438297-0002	6/2019
EM	006438297-0003	6/2019
EM	006438297-0004	6/2019
EM	006438297-0005	6/2019
EM	006438297-0006	6/2019
EM	006438297-0007	6/2019
EM	006438297-0008	6/2019
EM	008010771-0001	7/2020
EM	008050926-0001	8/2020
EM	008051767-0001	8/2020
EM	008008593-0001	10/2020
EM	008705537-0001	* 11/2021
EM	008705537-0002	* 11/2021
EM	008705537-0003	* 11/2021
GB	6185192	* 1/2022
NZ	426022-0001	8/2020
NZ	426023-0001	8/2020
NZ	426024-0001	8/2020
NZ	426025-0001	8/2020

* cited by examiner

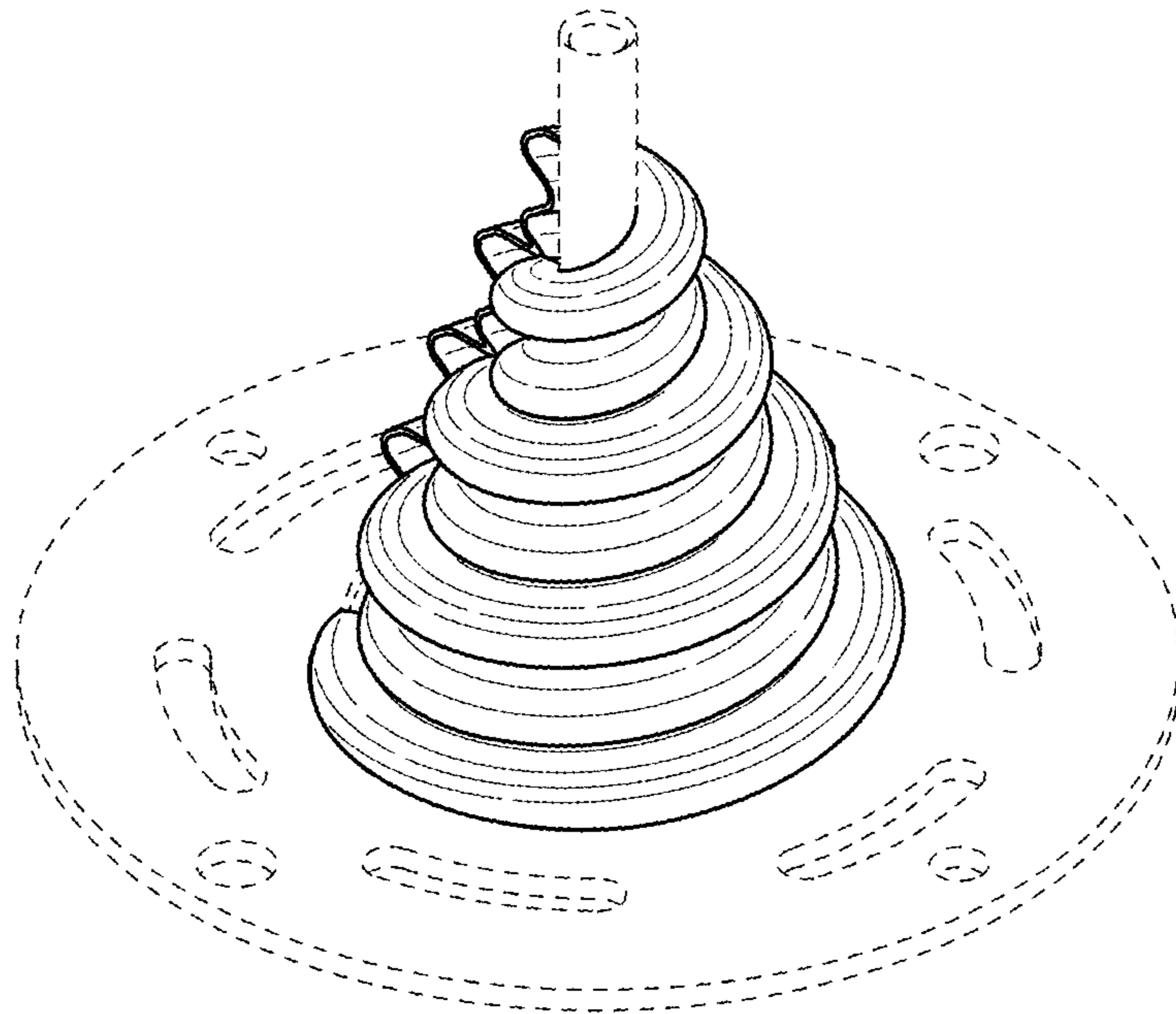

FIG. 1

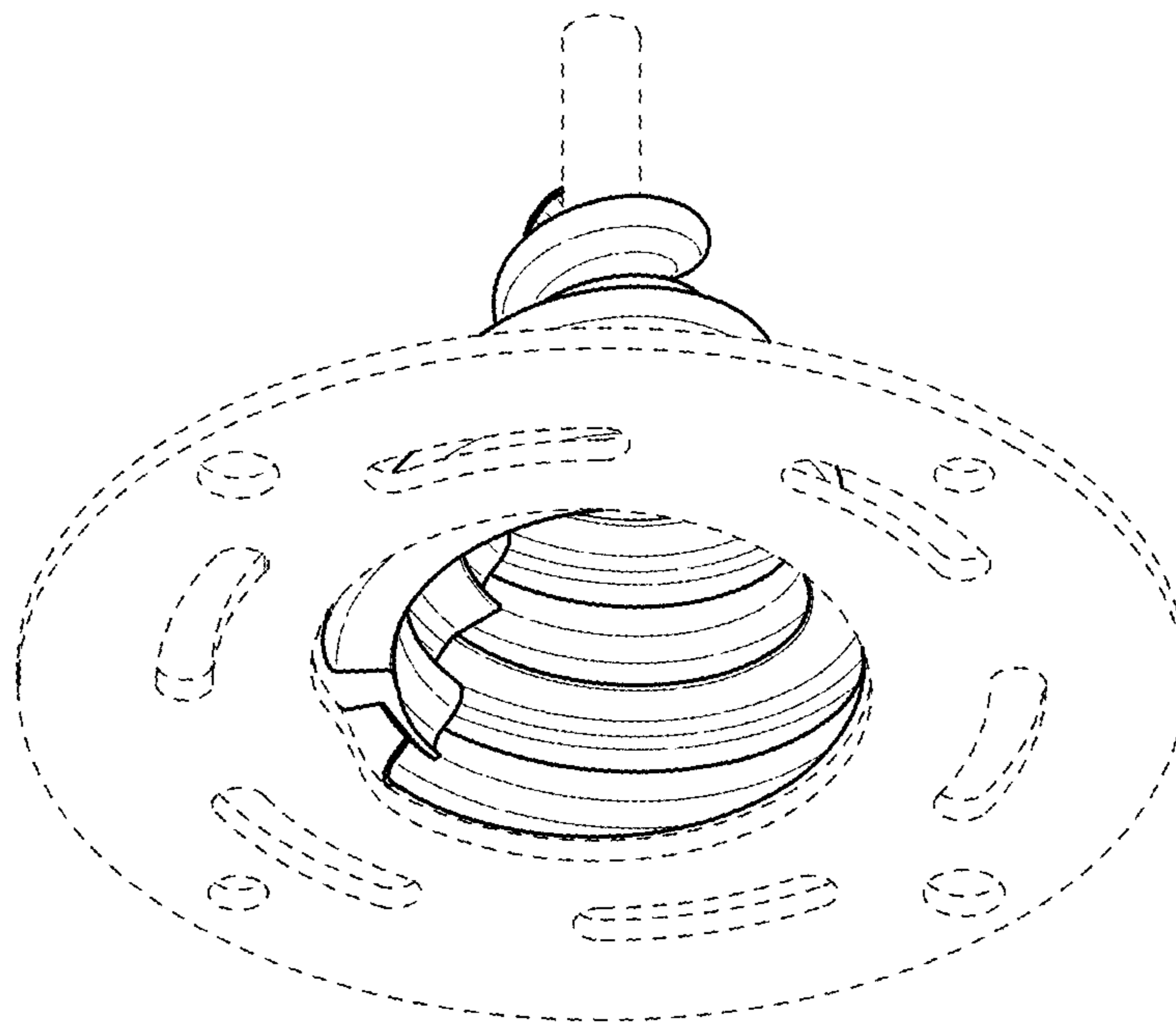

FIG. 2

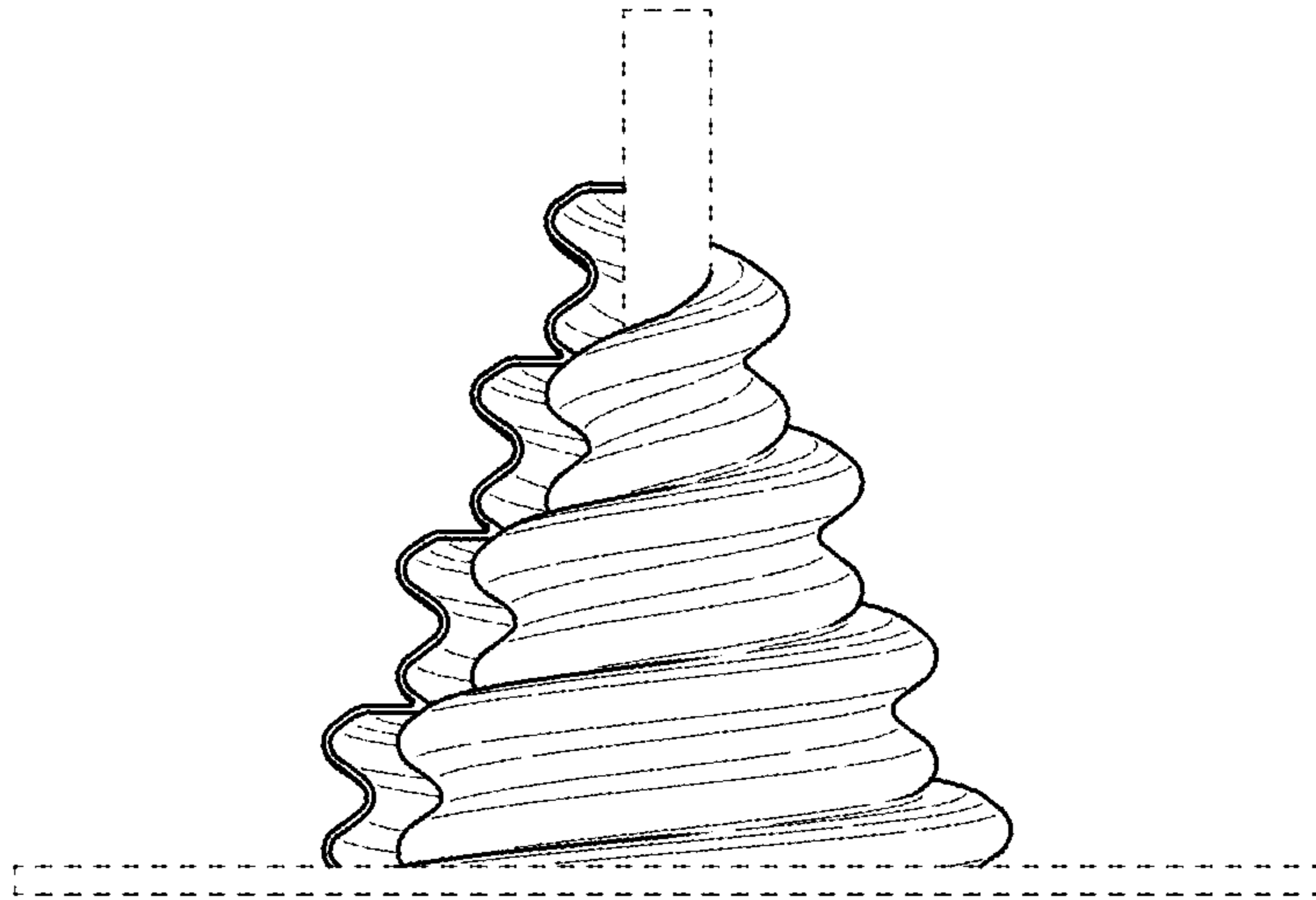

FIG. 3

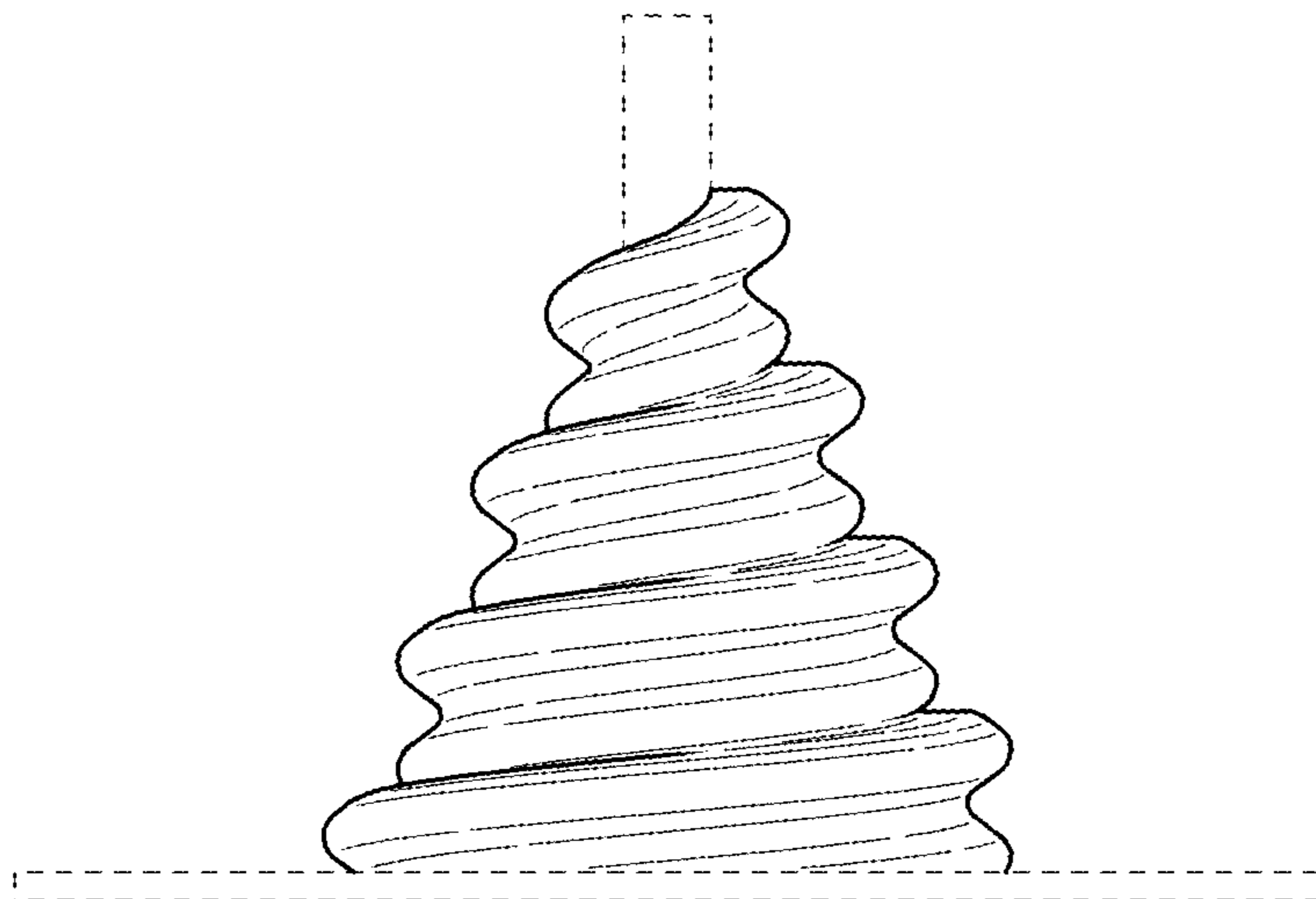

FIG. 4

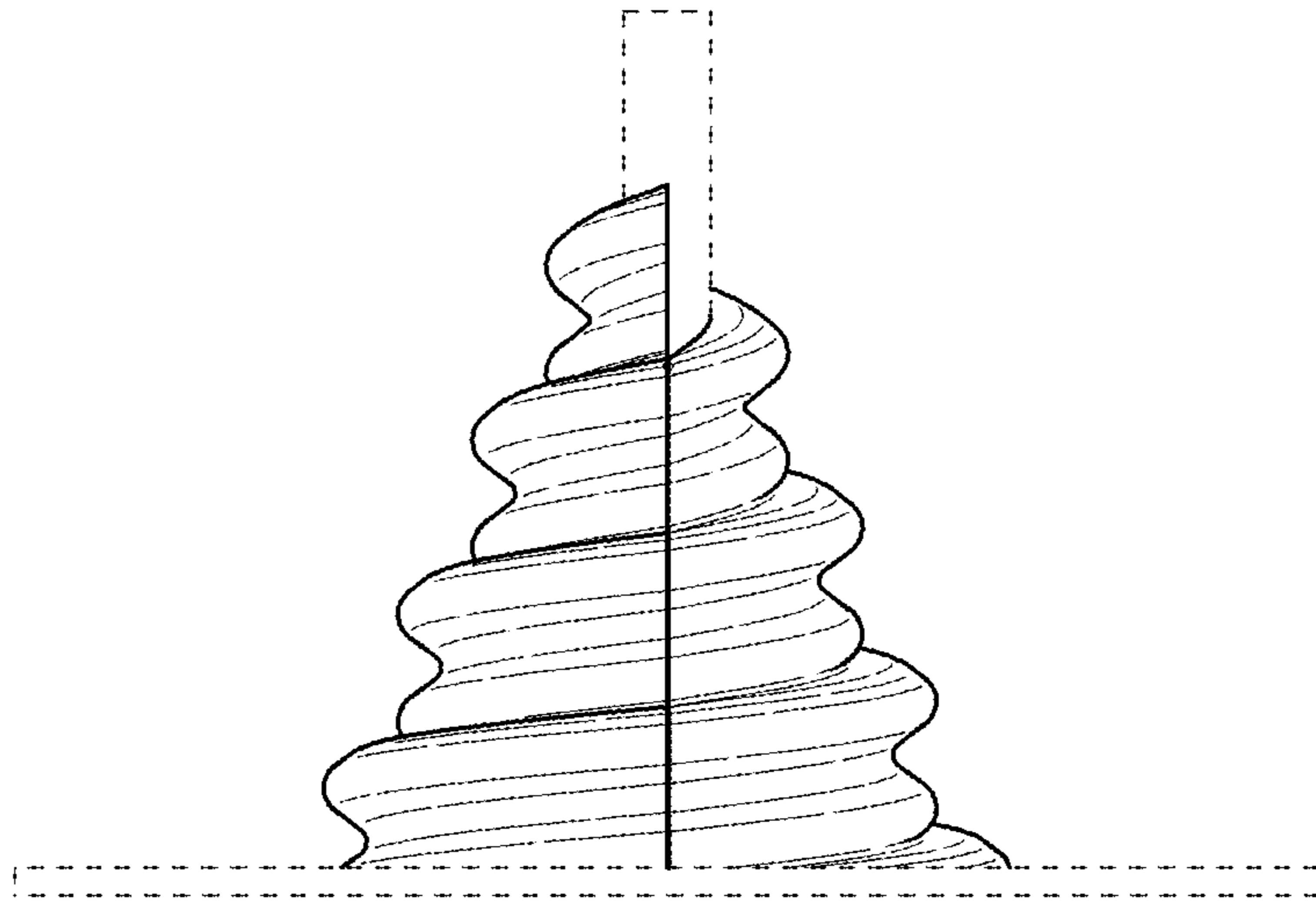

FIG. 5

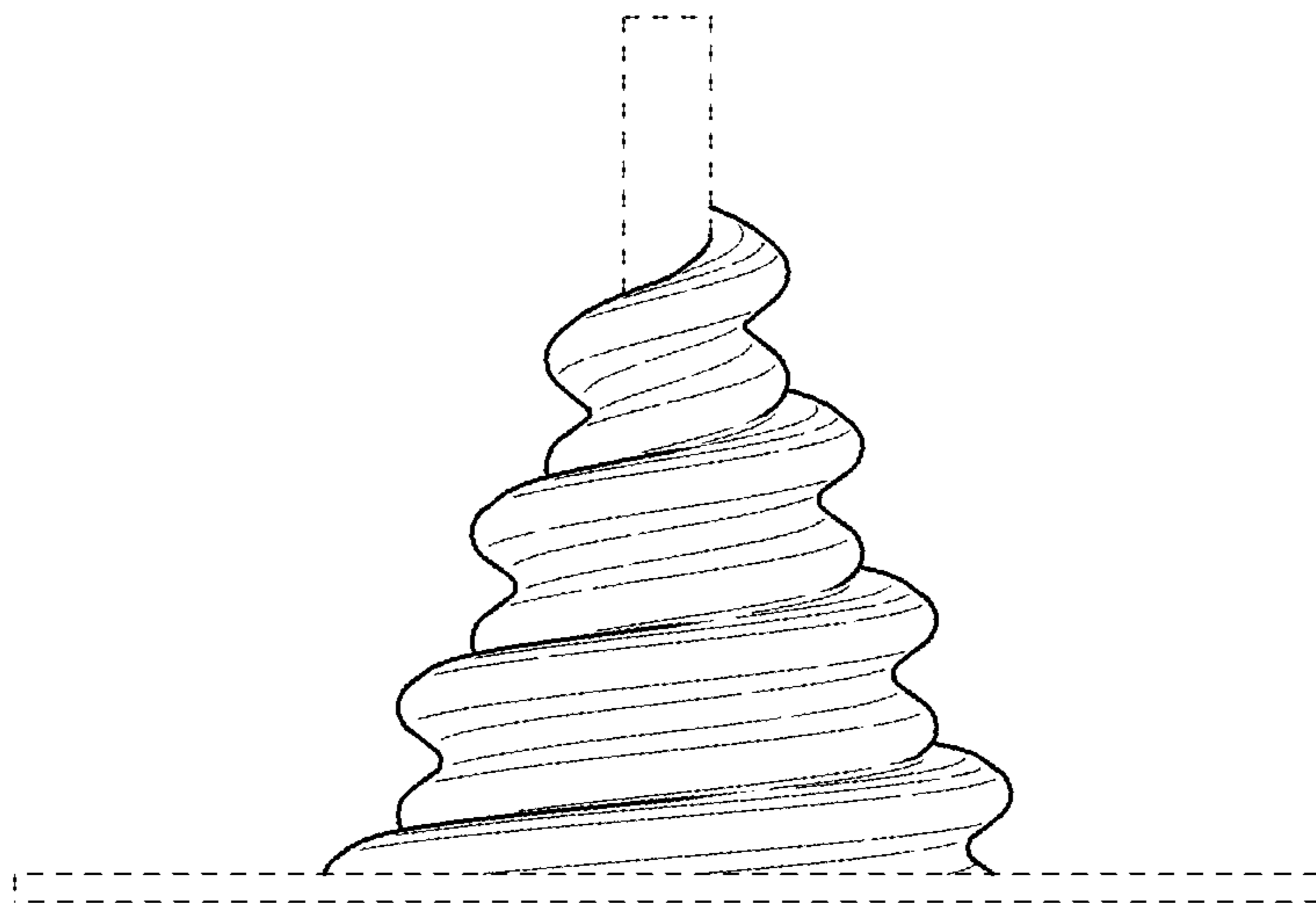

FIG. 6

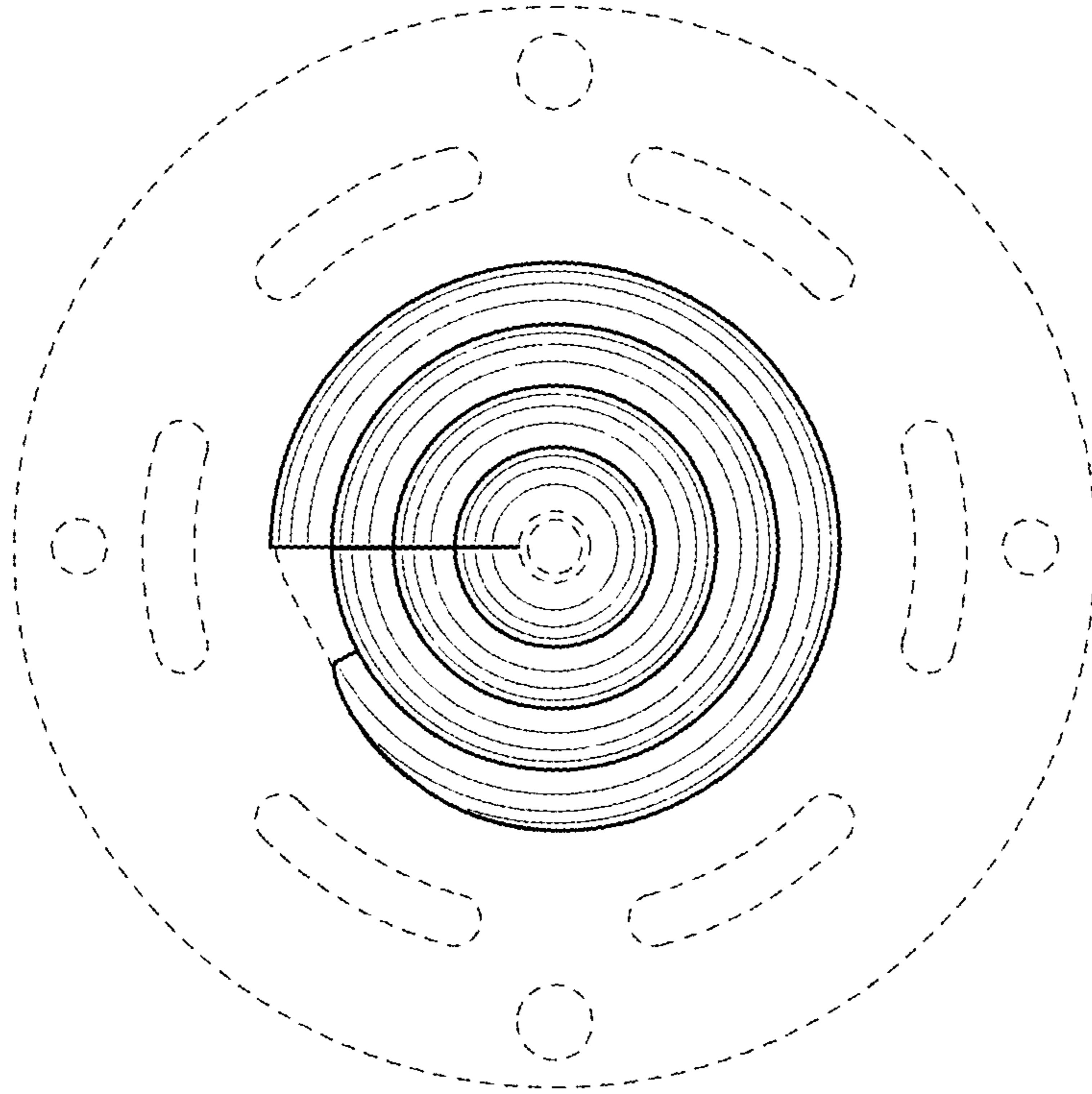

FIG. 7

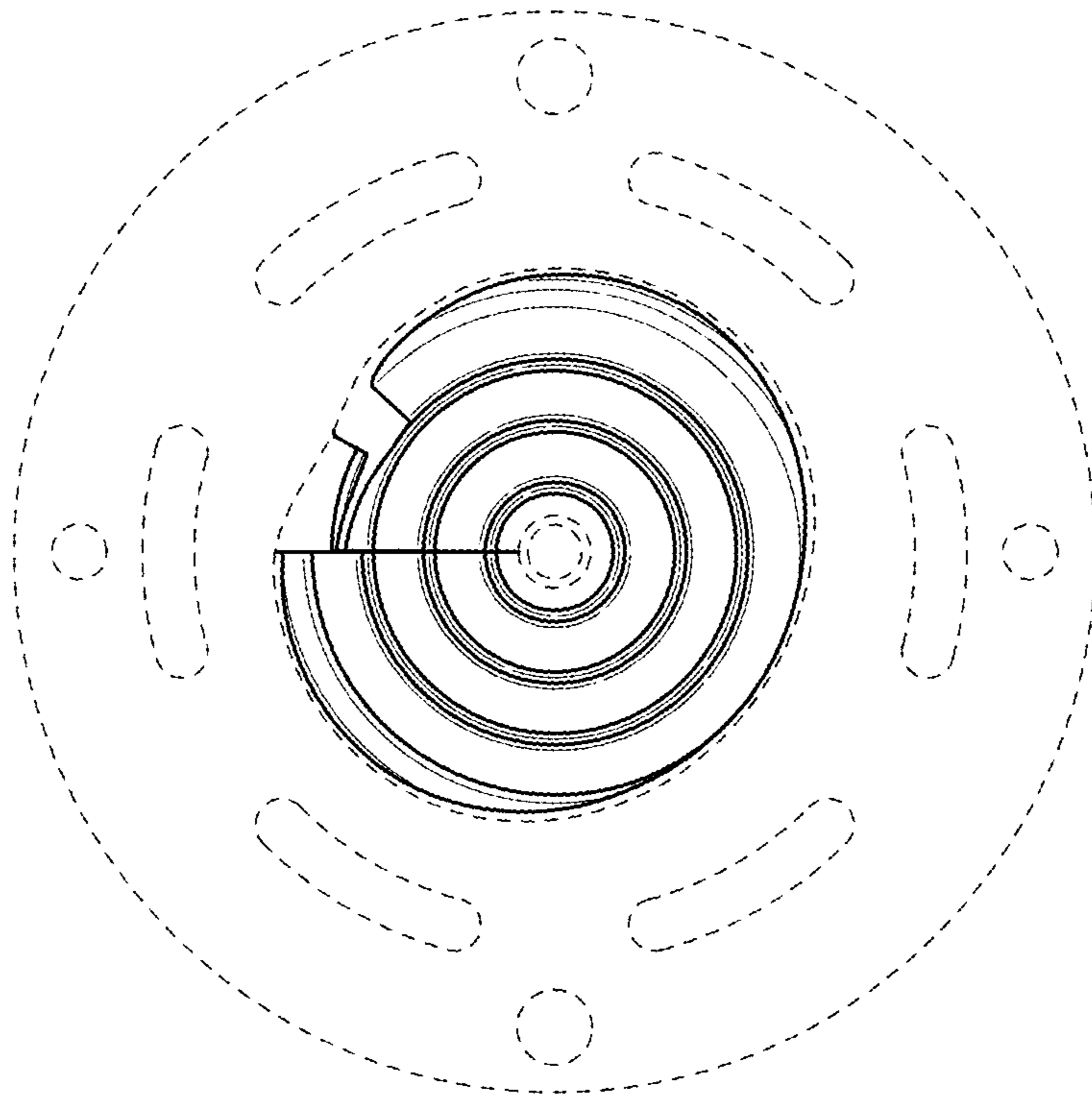

FIG. 8

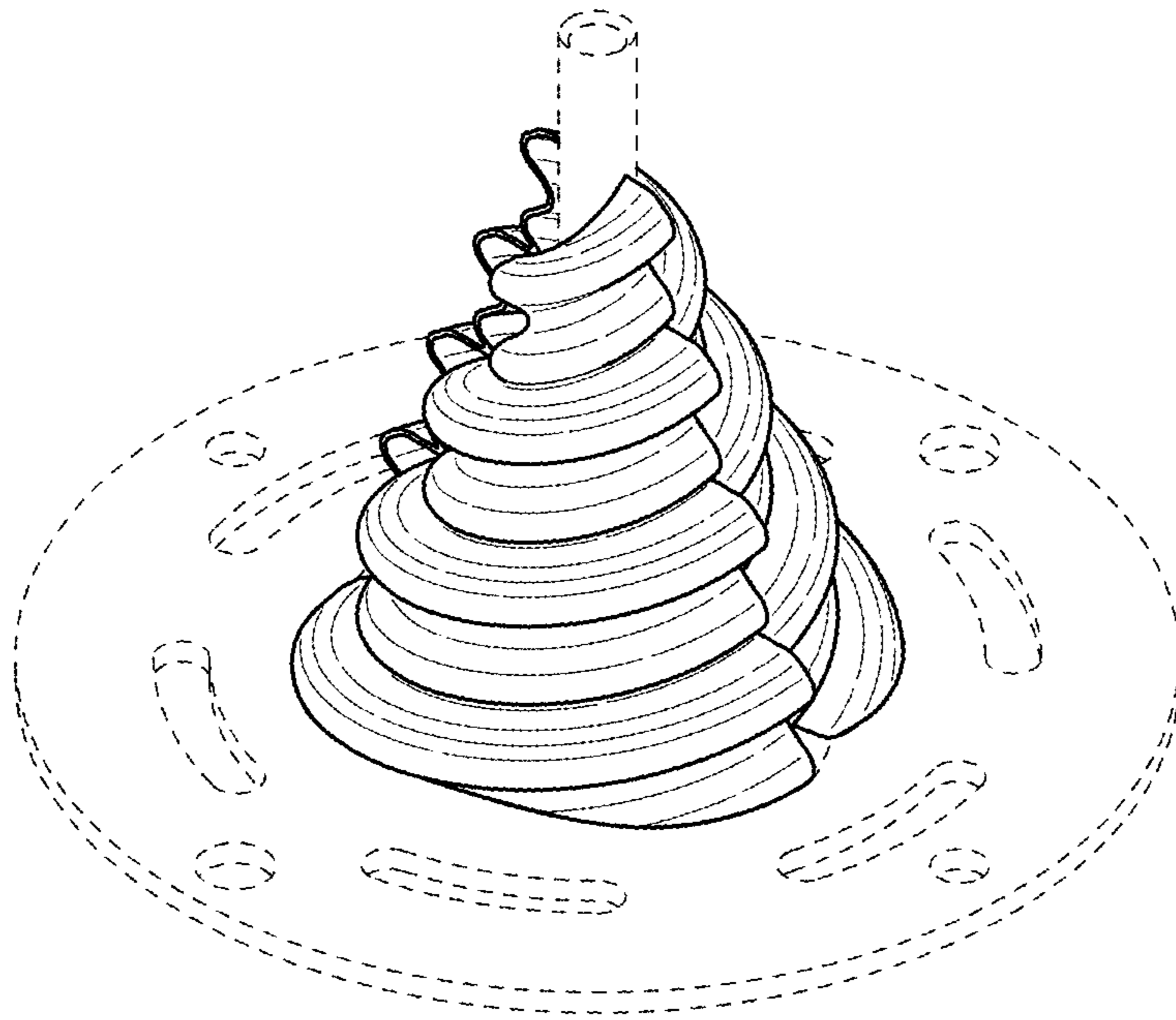

FIG. 9

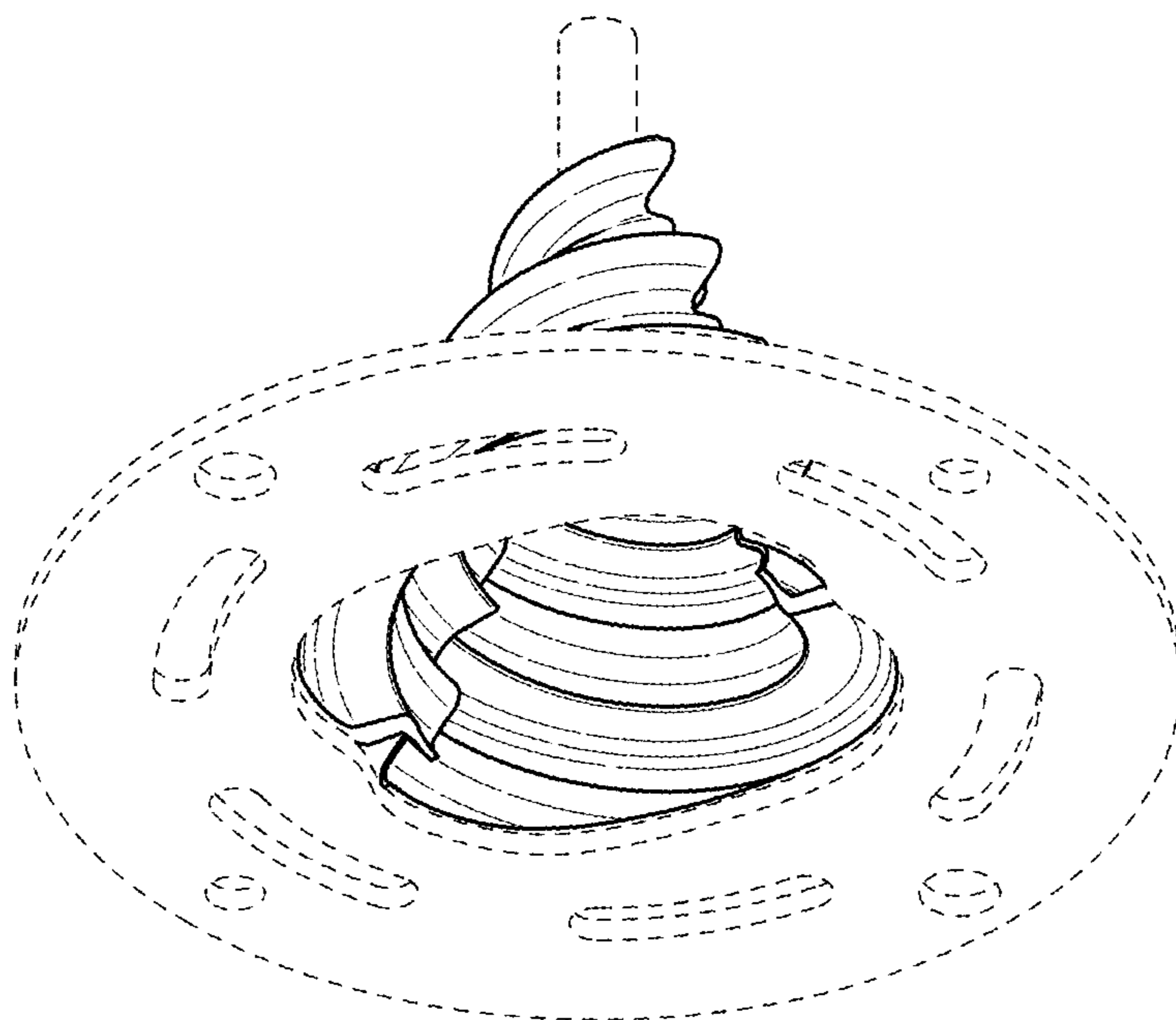

FIG. 10

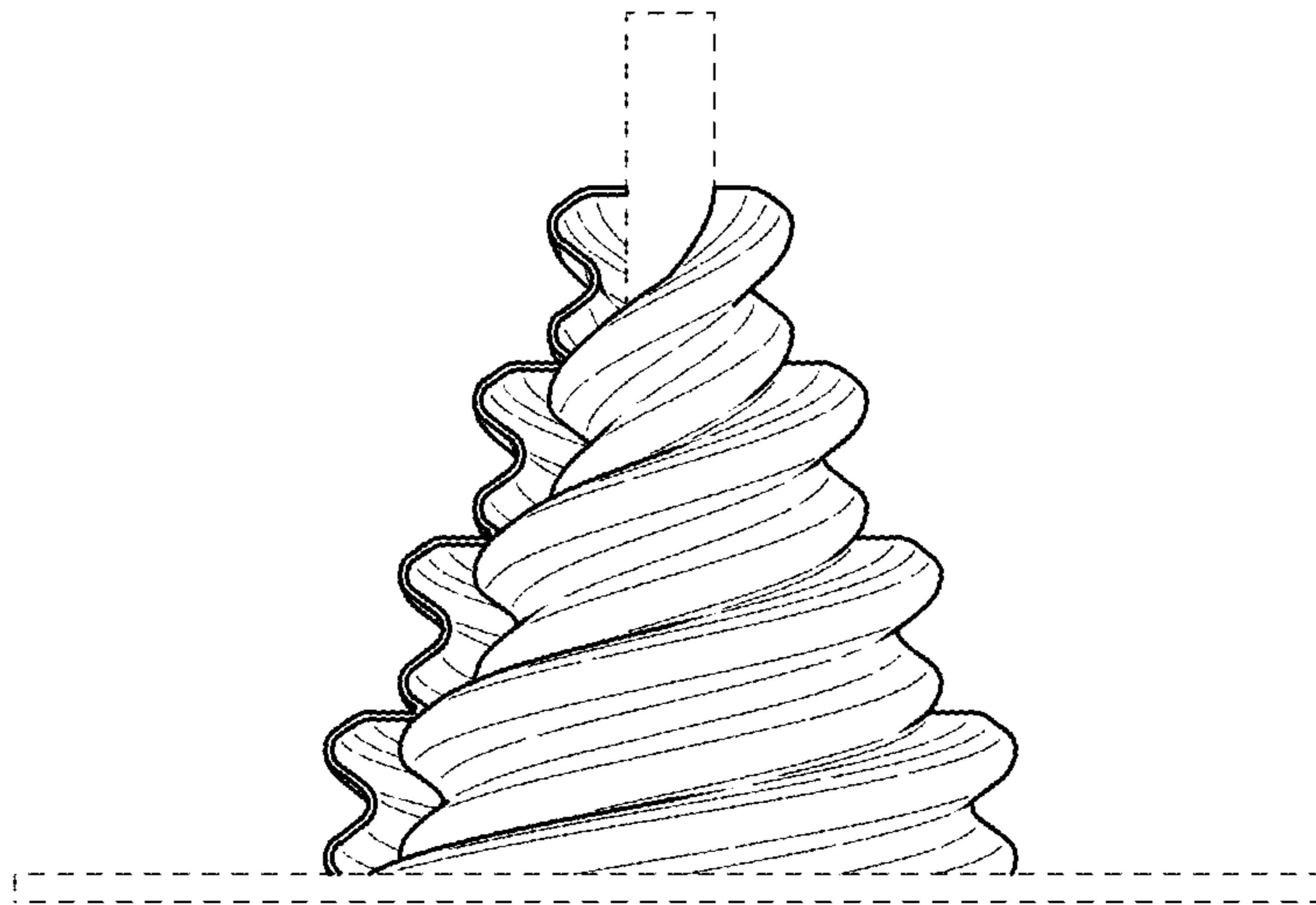

FIG. 11

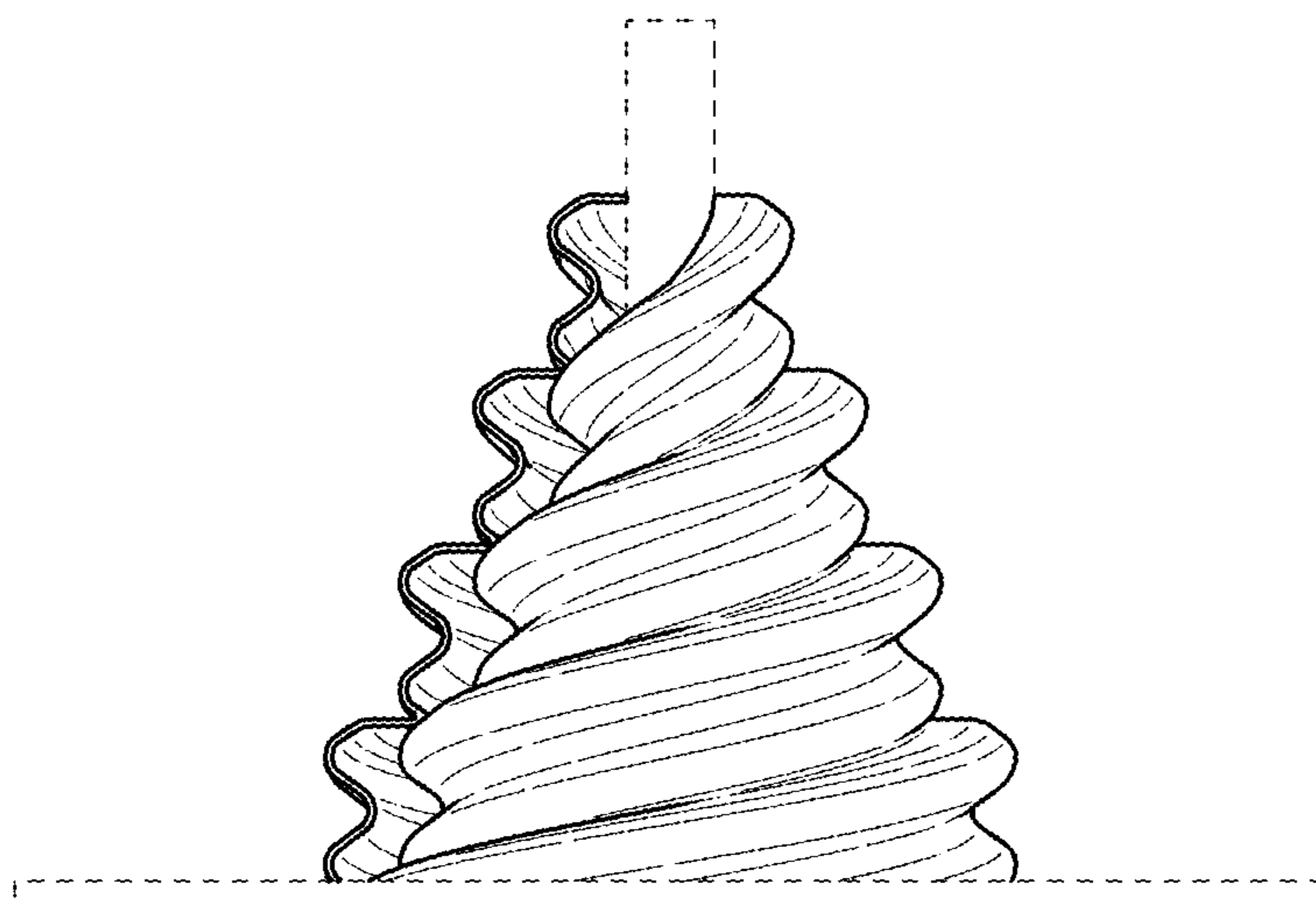

FIG. 12

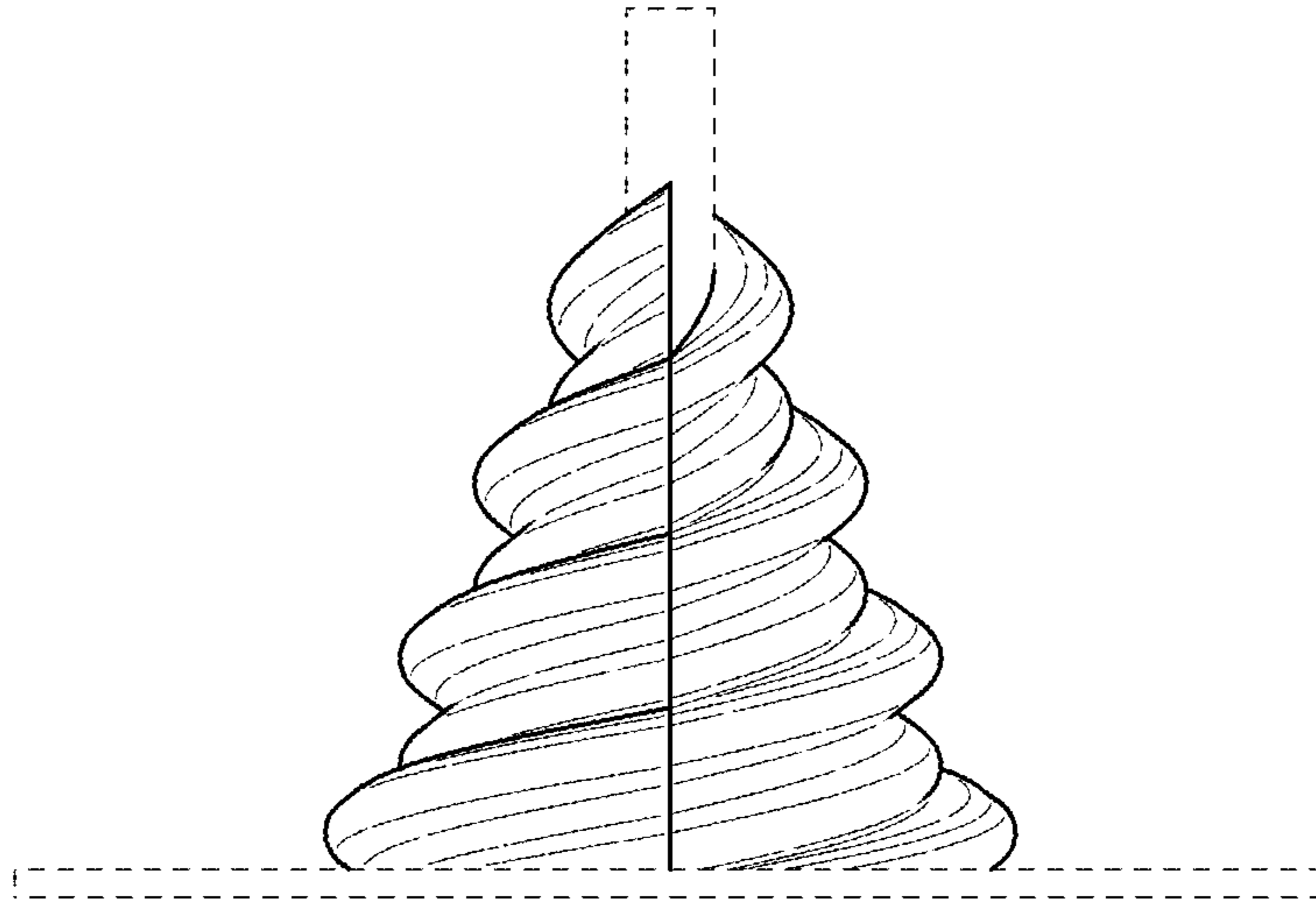

FIG. 13

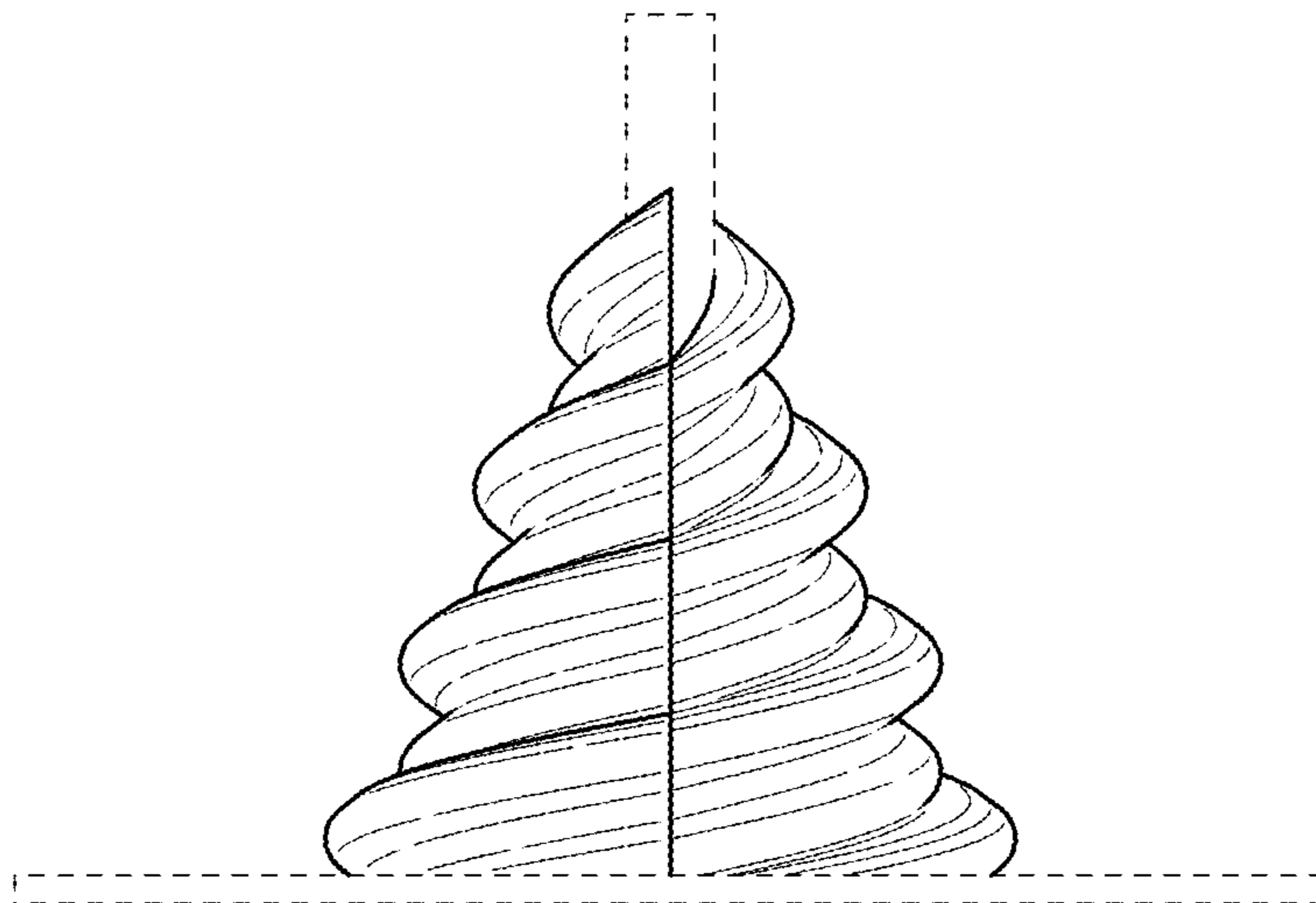

FIG. 14

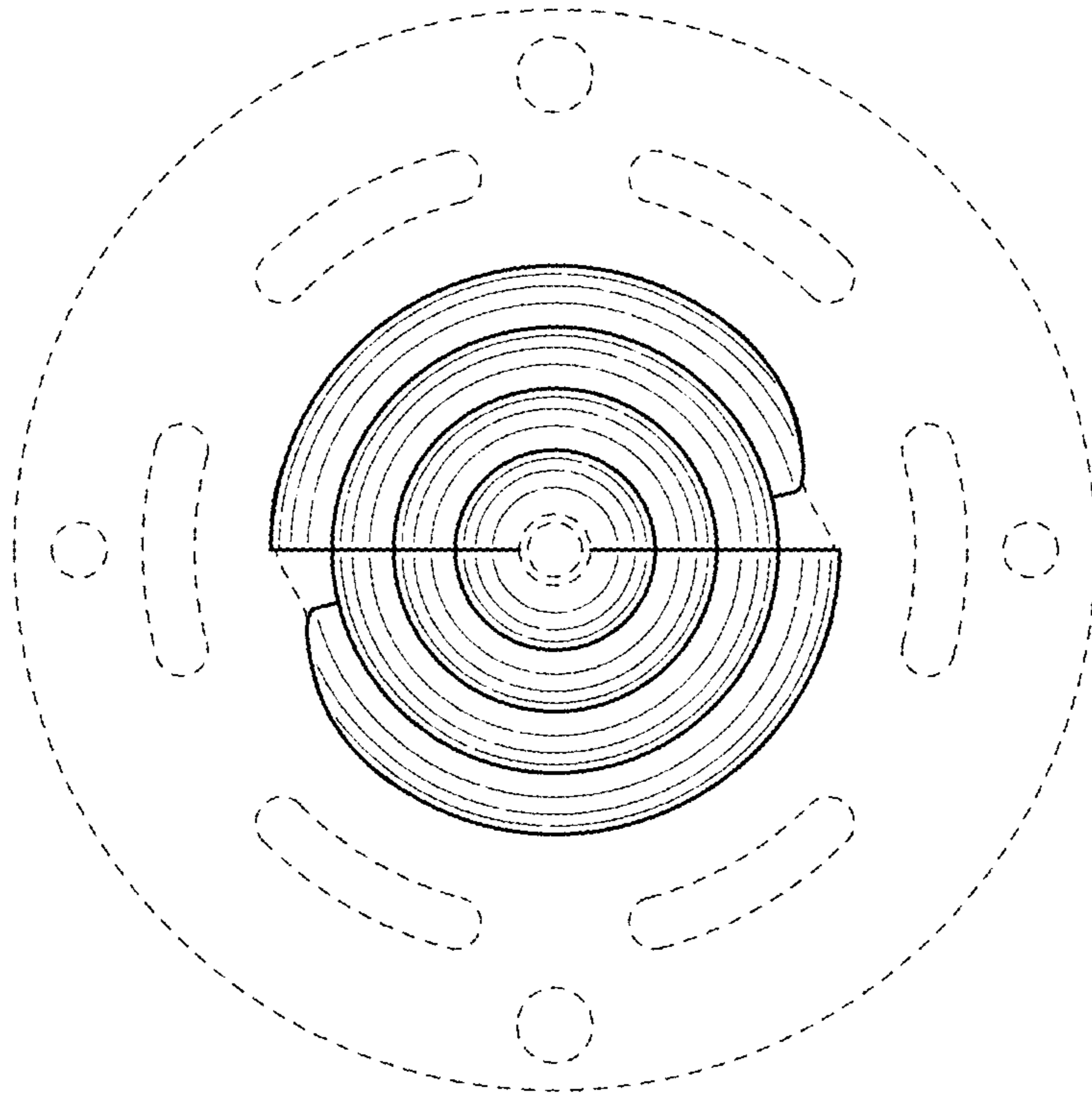

FIG. 15

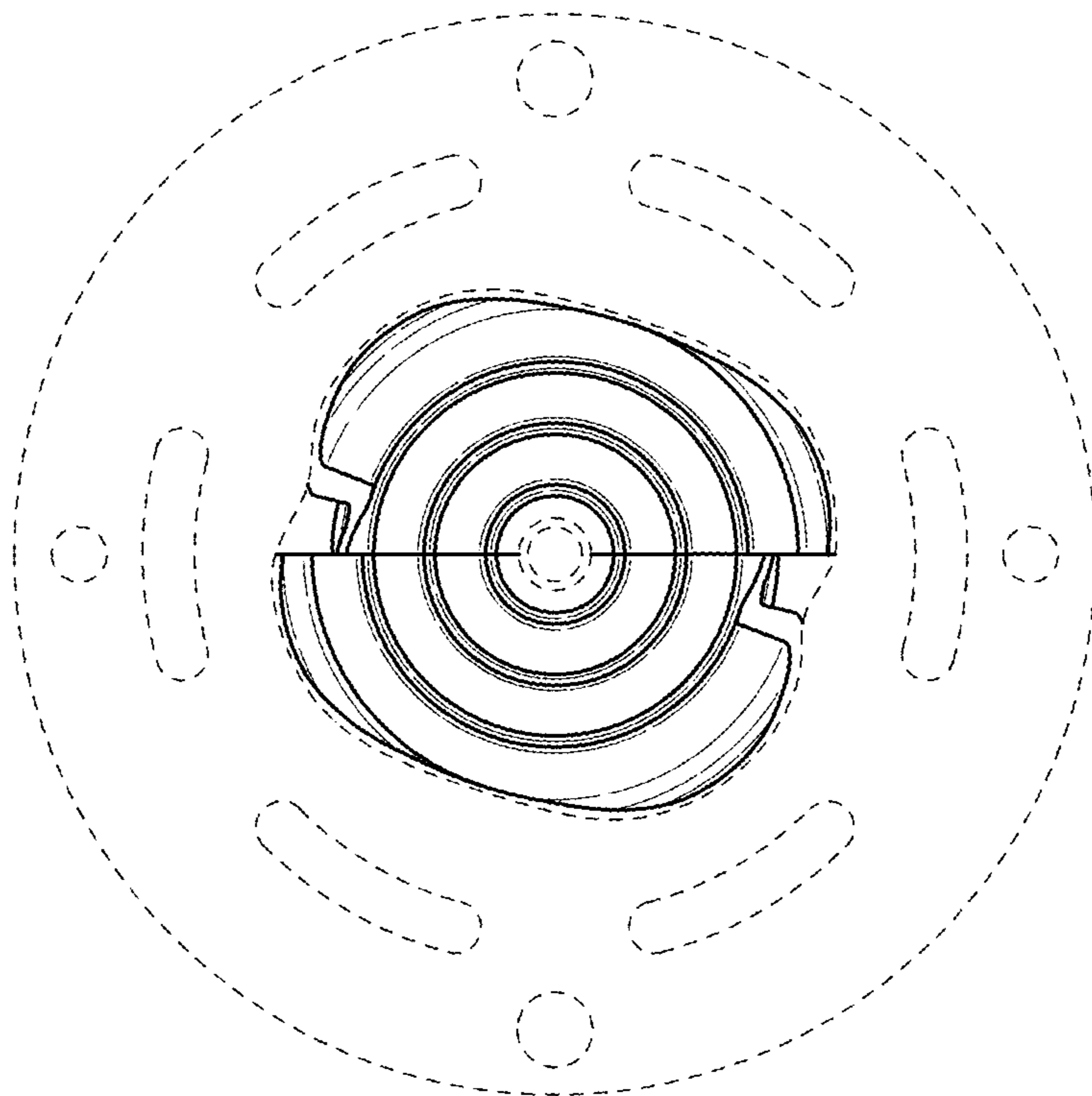

FIG. 16

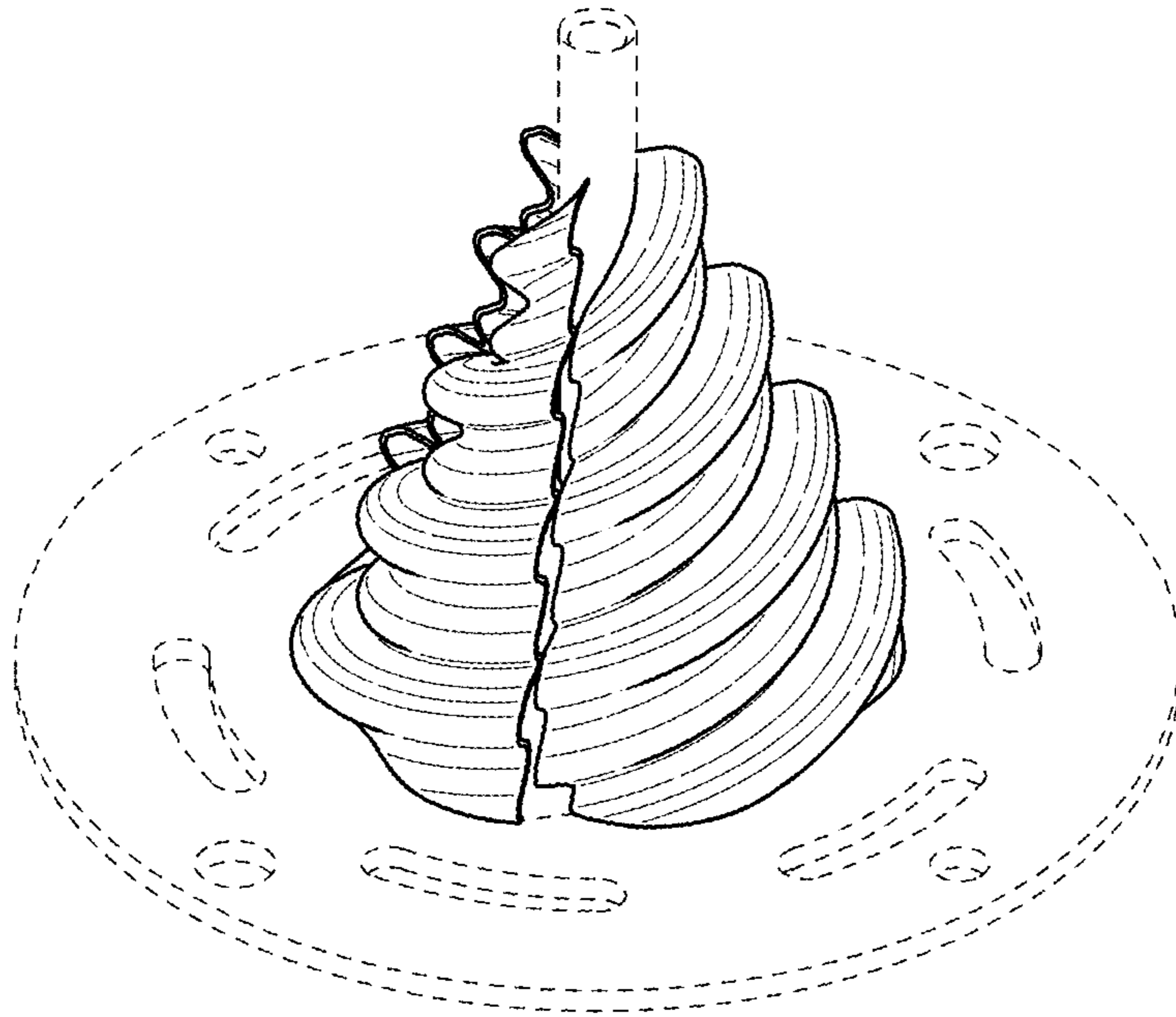

FIG. 17

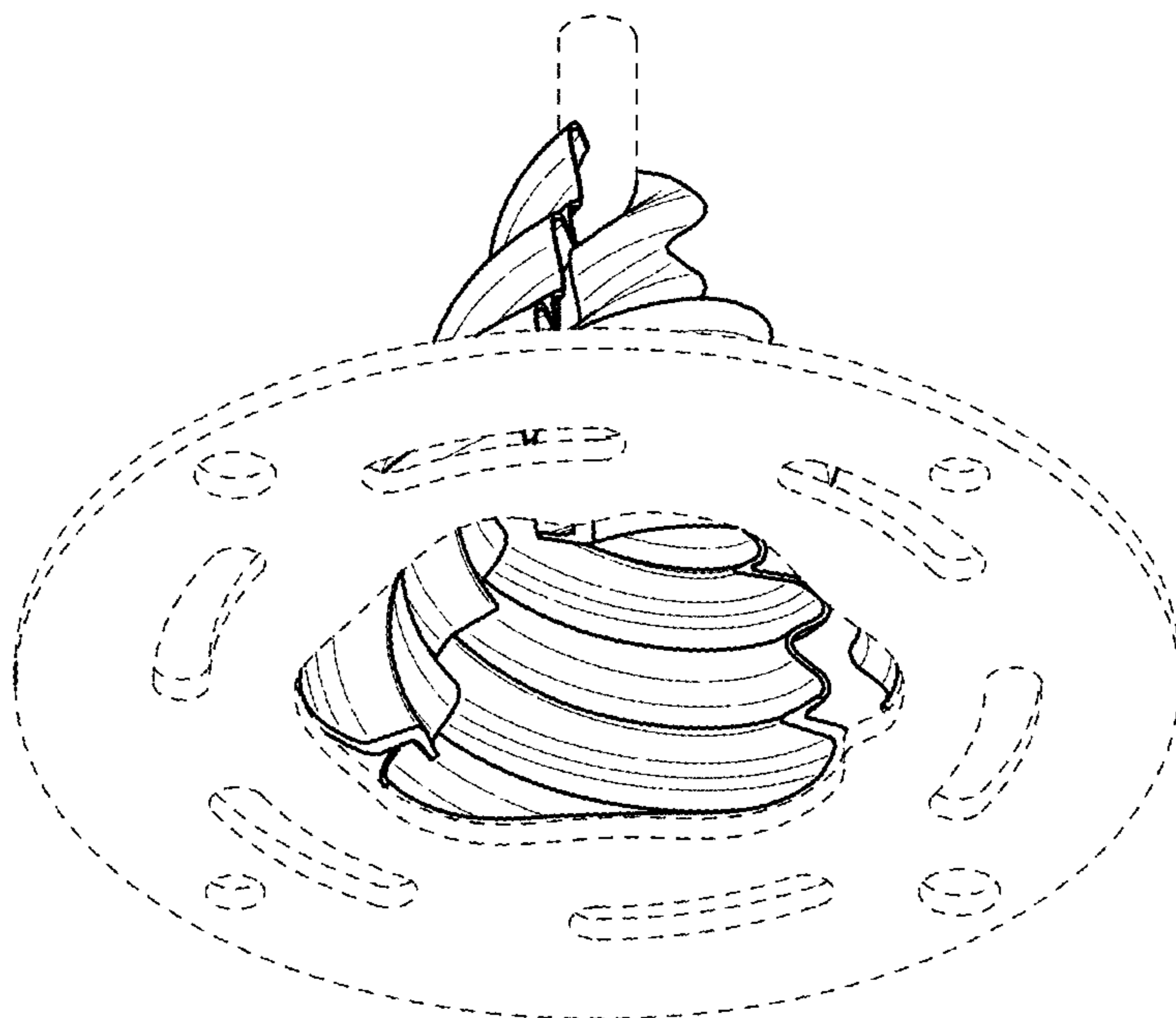

FIG. 18

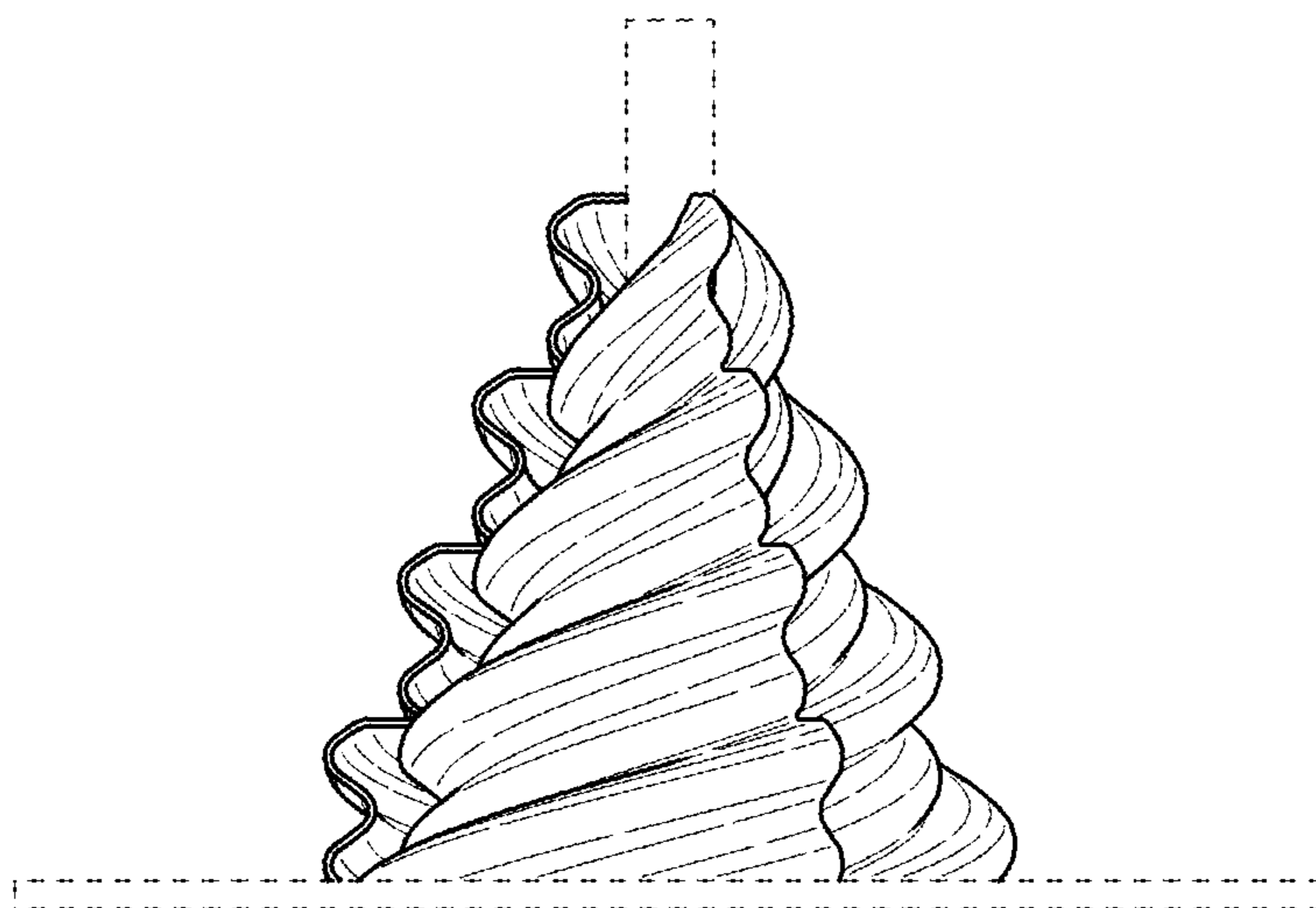

FIG. 19

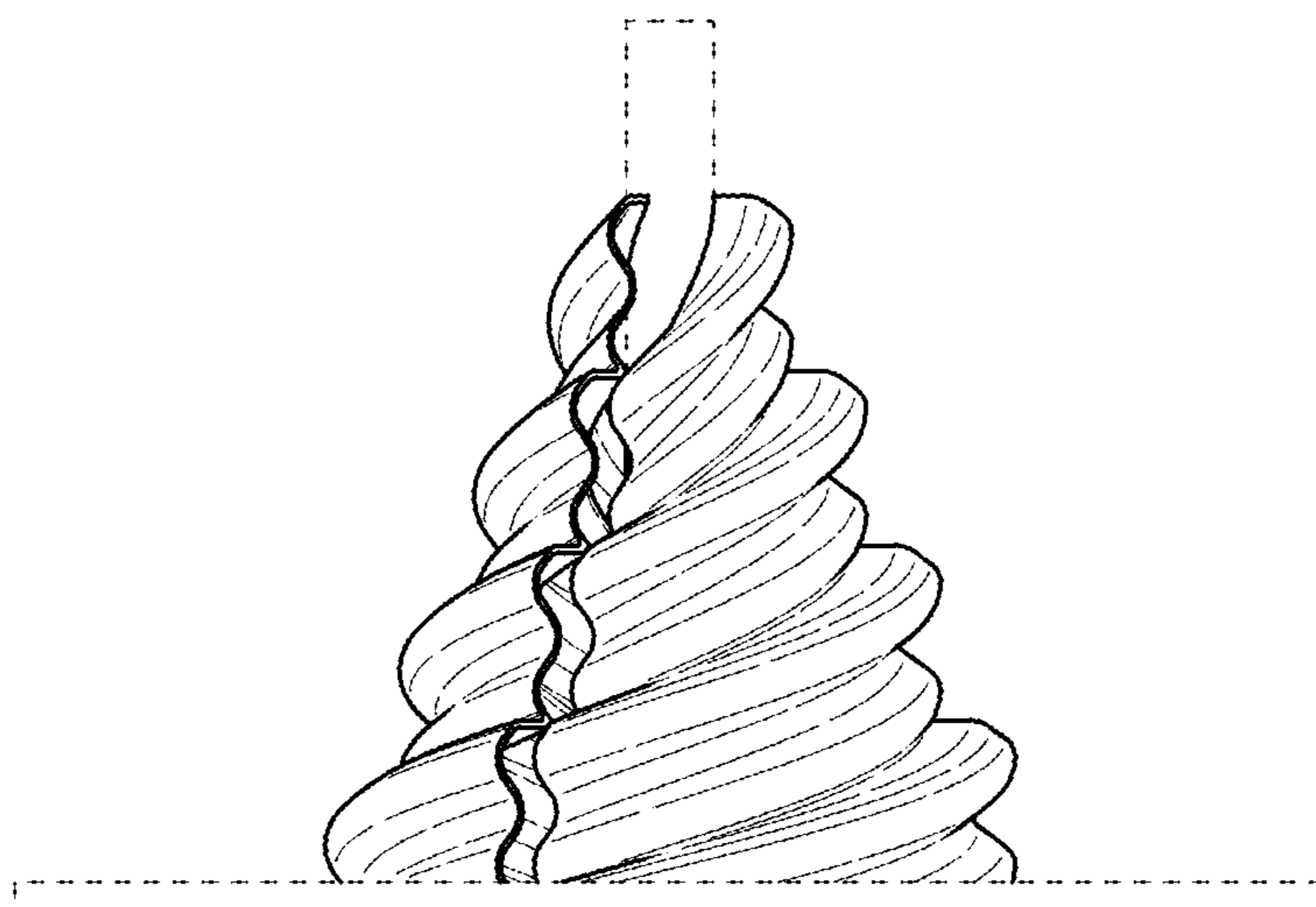

FIG. 20

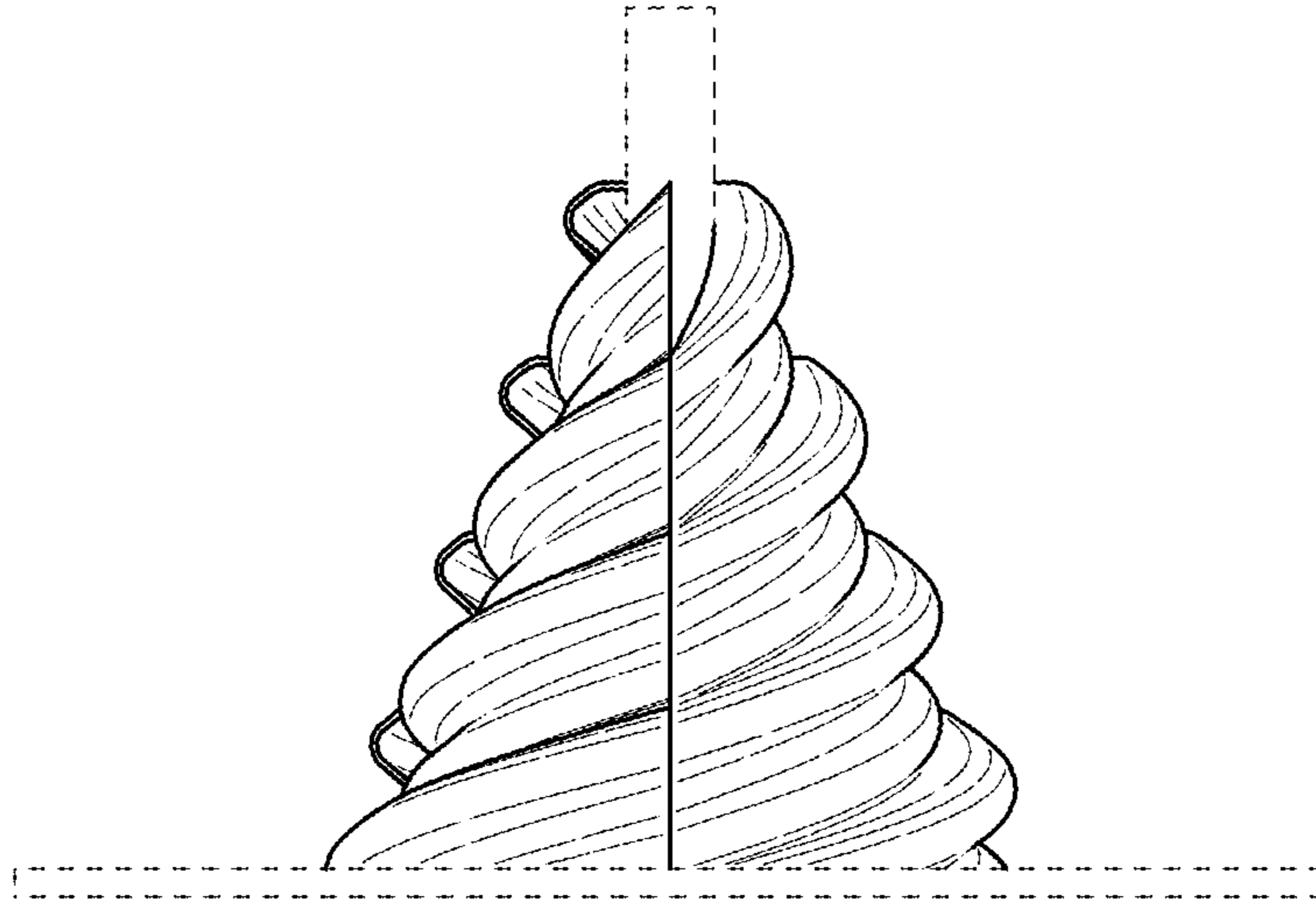

FIG. 21

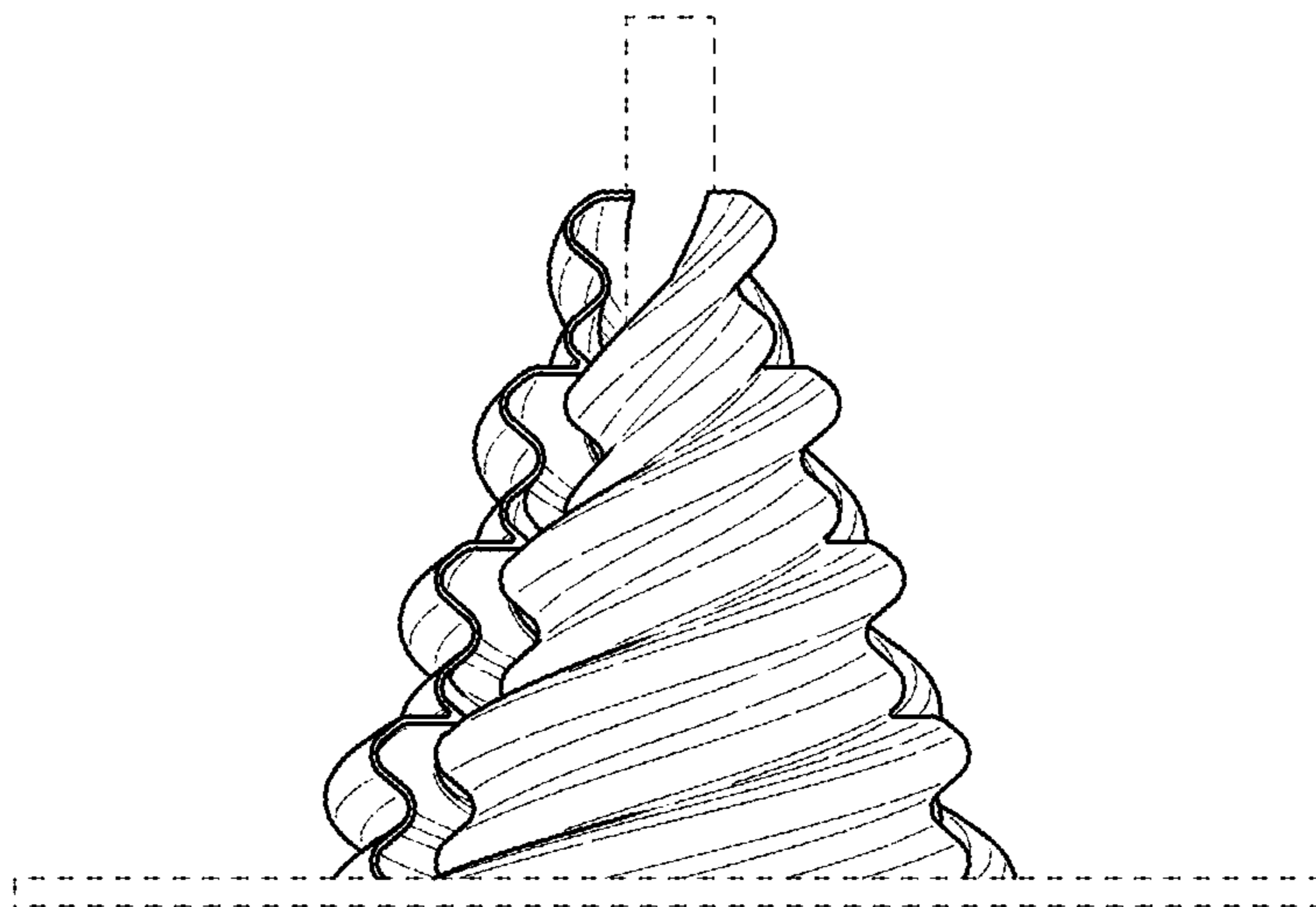

FIG. 22

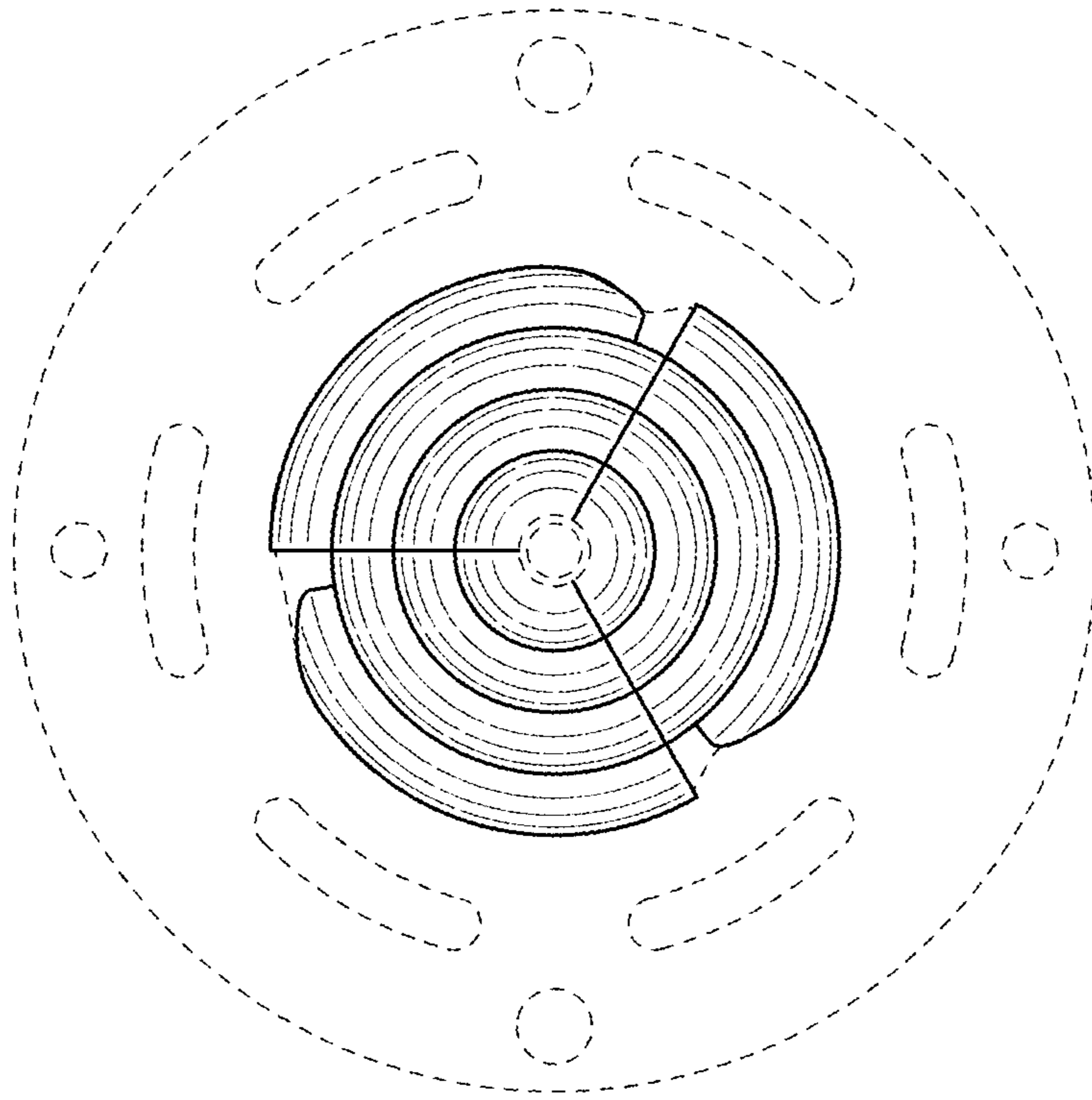

FIG. 23

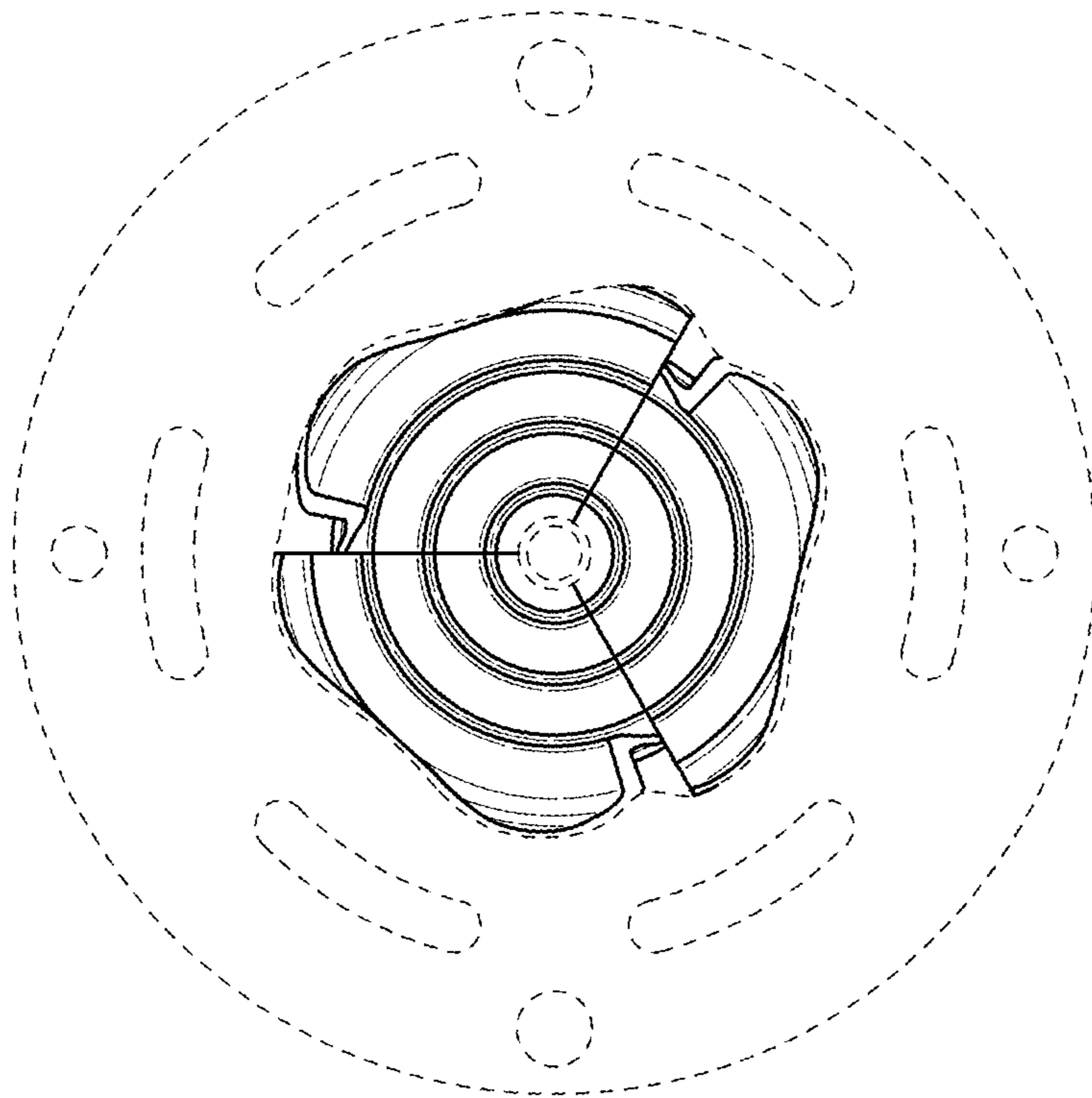

FIG. 24