



US00D976606S

(12) **United States Design Patent**
Leng

(10) **Patent No.:** **US D976,606 S**
(45) **Date of Patent:** **** Jan. 31, 2023**

- (54) **FRAME FOR SOFA BED**
- (71) Applicant: **NEW-TEC INTEGRATION (XIAMEN) CO., LTD.**, Fujian (CN)
- (72) Inventor: **Luhao Leng**, Fujian (CN)
- (73) Assignee: **NEW-TEC INTEGRATION (XIAMEN) CO., LTD.**, Xiamen (CN)
- (**) Term: **15 Years**
- (21) Appl. No.: **29/784,923**
- (22) Filed: **May 21, 2021**
- (30) **Foreign Application Priority Data**
- Apr. 29, 2021 (CN) 202130256998.2
- (51) **LOC (14) Cl.** **06-01**
- (52) **U.S. Cl.**
- USPC **D6/381; D6/335**
- (58) **Field of Classification Search**
- USPC D6/334, 335, 367, 368, 370, 381, 382, D6/383, 392

(Continued)

(56) **References Cited**

U.S. PATENT DOCUMENTS

- 2,111,415 A 3/1938 Arton
- 4,209,198 A * 6/1980 Apple, Sr. A47C 4/02 297/448.1

(Continued)

FOREIGN PATENT DOCUMENTS

- CN 306556058 5/2021
- CN 115251635 A * 11/2022

OTHER PUBLICATIONS

Mainstay Metal Arm Futon [online], [site visited Sep. 2022]. Available from internet, URL: <<https://www.amazon.com/Mainstay-Metal-Futon-Mattress-Black/dp/B013U1QXJM/>> (Year: 2015).

Primary Examiner — Deanna L Pratt
(74) *Attorney, Agent, or Firm* — Perkins Coie LLP

(57) **CLAIM**

The ornamental design for a frame for sofa bed, as shown and described.

DESCRIPTION

FIG. 1 is a perspective view of the frame for sofa bed in an upright or sofa seating configuration, showing my new design.

FIG. 2 is a front elevation view of the frame shown in FIG. 1.

FIG. 3 is a back elevation view of the frame shown in FIG. 1.

FIG. 4 is a left side view of the frame shown in FIG. 1.

FIG. 5 is a right side view of the frame shown in FIG. 1.

FIG. 6 is a top plan view of the frame shown in FIG. 1.

FIG. 7 is a bottom plan view of the frame shown in FIG. 1.

FIG. 8 is a perspective view of the hinged folding unit of the frame for sofa bed shown in FIGS. 1-7, shown in a flat configuration, and shown separated from the frame for completeness of disclosure.

FIG. 9 is an enlarged view of portion “A” shown in FIG. 8.

FIG. 10 is a perspective view of the frame for sofa bed shown in FIGS. 1-9, shown folded out into a flat or bed configuration.

FIG. 11 is a front elevation view of the frame shown in FIG. 10.

FIG. 12 is a back elevation view of the frame shown in FIG. 10.

FIG. 13 is a left side view of the frame shown in FIG. 10.

FIG. 14 is a right side view of the frame shown in FIG. 10.

FIG. 15 is a top plan view of the frame shown in FIG. 10; and,

FIG. 16 is a bottom plan view of the frame shown in FIG. 10.

1 Claim, 8 Drawing Sheets

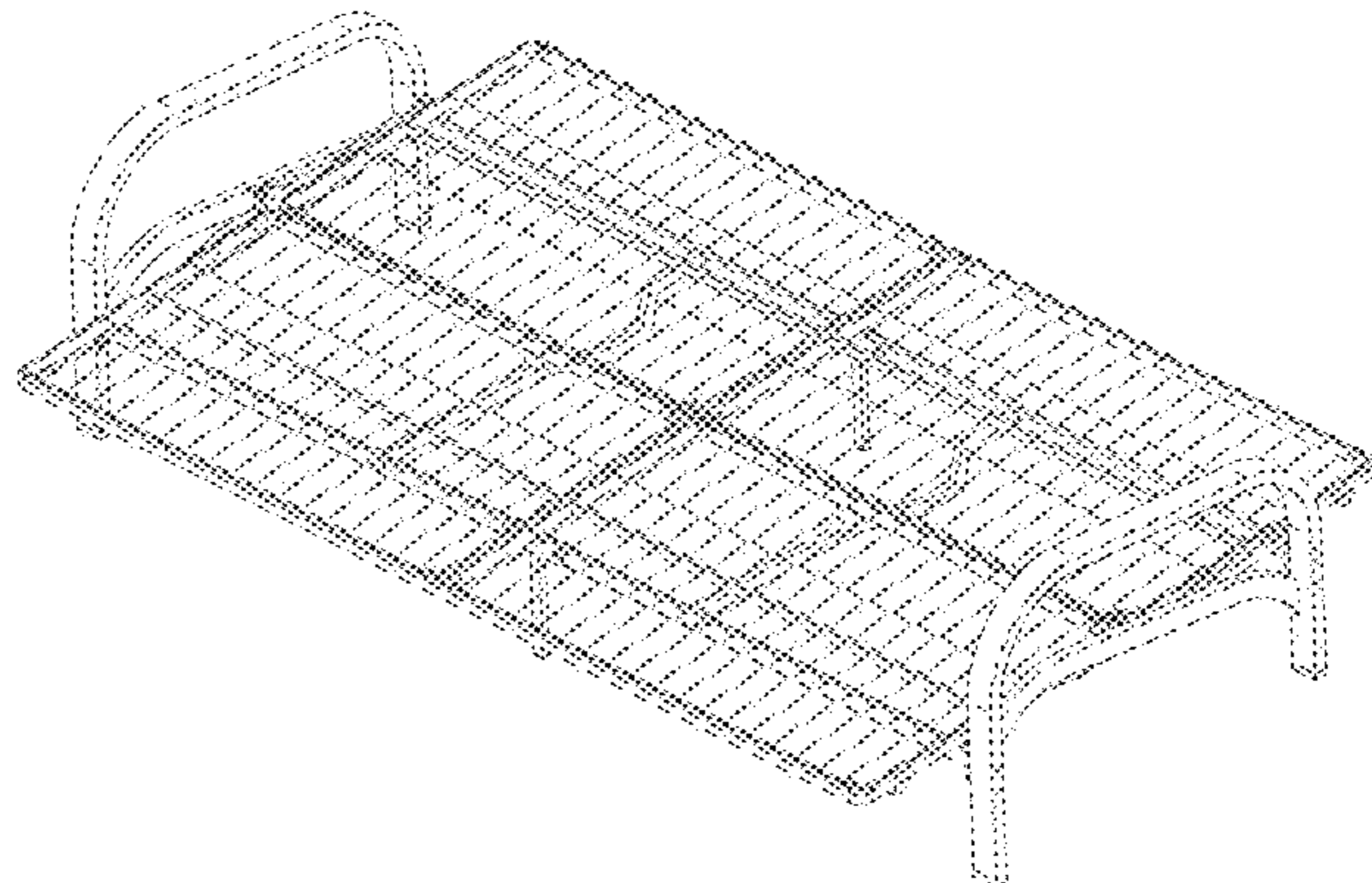
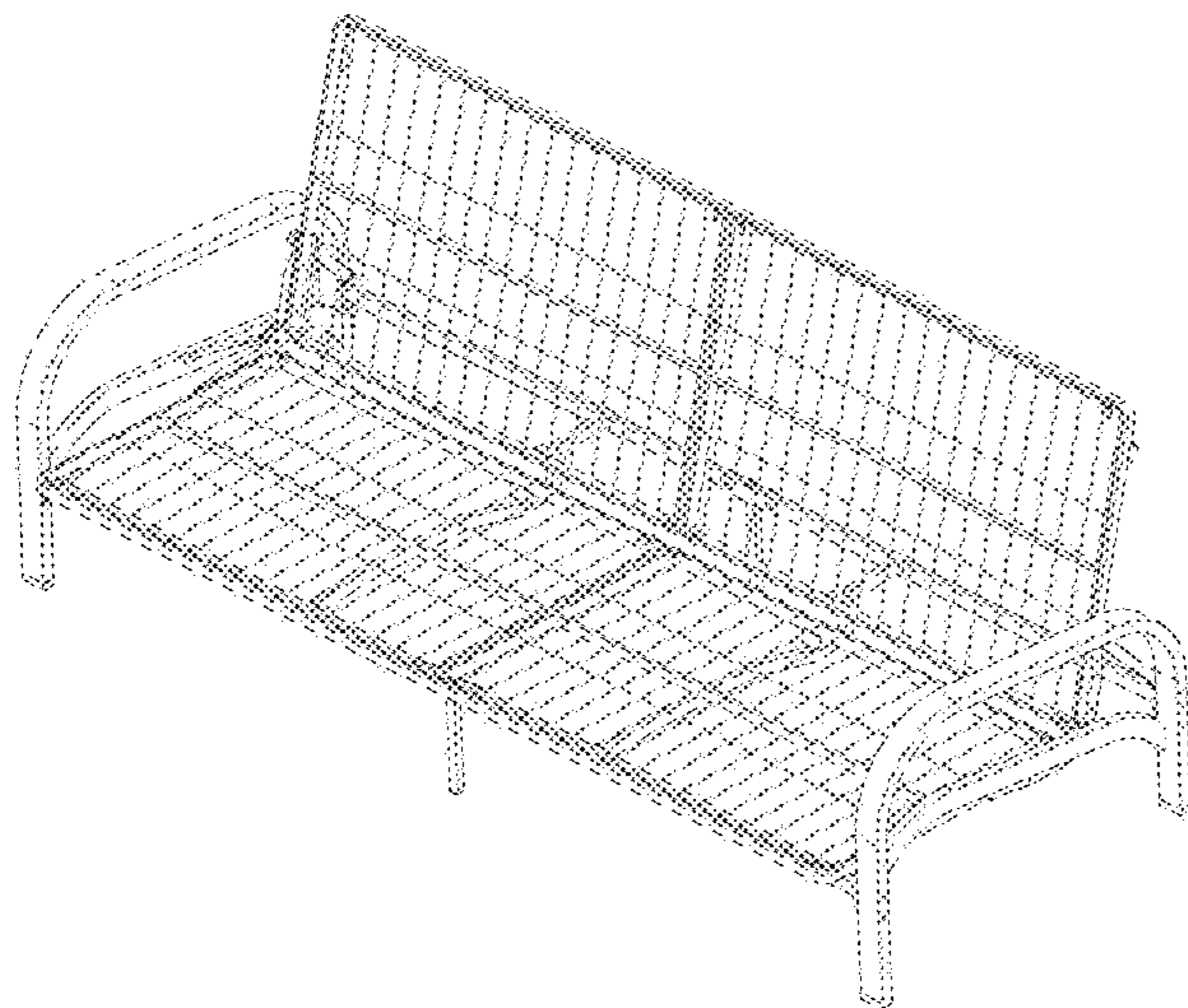

US D976,606 S

Page 2

(58) **Field of Classification Search**

CPC A47C 17/16; A47C 17/161; A47C 17/162;
A47C 17/163; A47C 17/17; A47C
17/175; A47C 17/1753; A47D 11/005;
A47D 11/00

See application file for complete search history.

D591,970 S 5/2009 Weiss
D603,617 S 11/2009 Weiss
D603,618 S 11/2009 Weiss
D604,957 S 12/2009 Weiss
D649,367 S 11/2011 Andersen
9,259,093 B2 2/2016 Leng
D811,100 S 2/2018 Andersen
10,512,337 B2 * 12/2019 Leng A47C 17/1756
2001/0044956 A1 * 11/2001 Laurendeau A47C 17/16
5/37.1

(56) **References Cited**

U.S. PATENT DOCUMENTS

D363,171 S * 10/1995 Kramer D6/381
5,528,778 A 6/1996 Shrock et al.
D391,776 S * 3/1998 Olender D6/381
D392,115 S * 3/1998 Olender D6/381
5,960,491 A * 10/1999 Olender A47C 17/1753
5/47
6,209,154 B1 4/2001 Huang
D455,281 S * 4/2002 Andersen D6/381
D455,282 S * 4/2002 Andersen D6/381

2015/0196128 A1 7/2015 Leng
2018/0035816 A1 2/2018 Leng
2022/0225780 A1 * 7/2022 Leng A47C 17/1753
2022/0225781 A1 * 7/2022 Leng A47C 17/1753
2022/0346555 A1 * 11/2022 Leng A47C 17/1753
2022/0346556 A1 * 11/2022 Leng A47C 17/1753
2022/0346557 A1 * 11/2022 Leng A47C 17/1753
2022/0346558 A1 * 11/2022 Leng A47C 7/54
2022/0346559 A1 * 11/2022 Leng A47C 7/54
2022/0346560 A1 * 11/2022 Leng A47C 17/1756

* cited by examiner

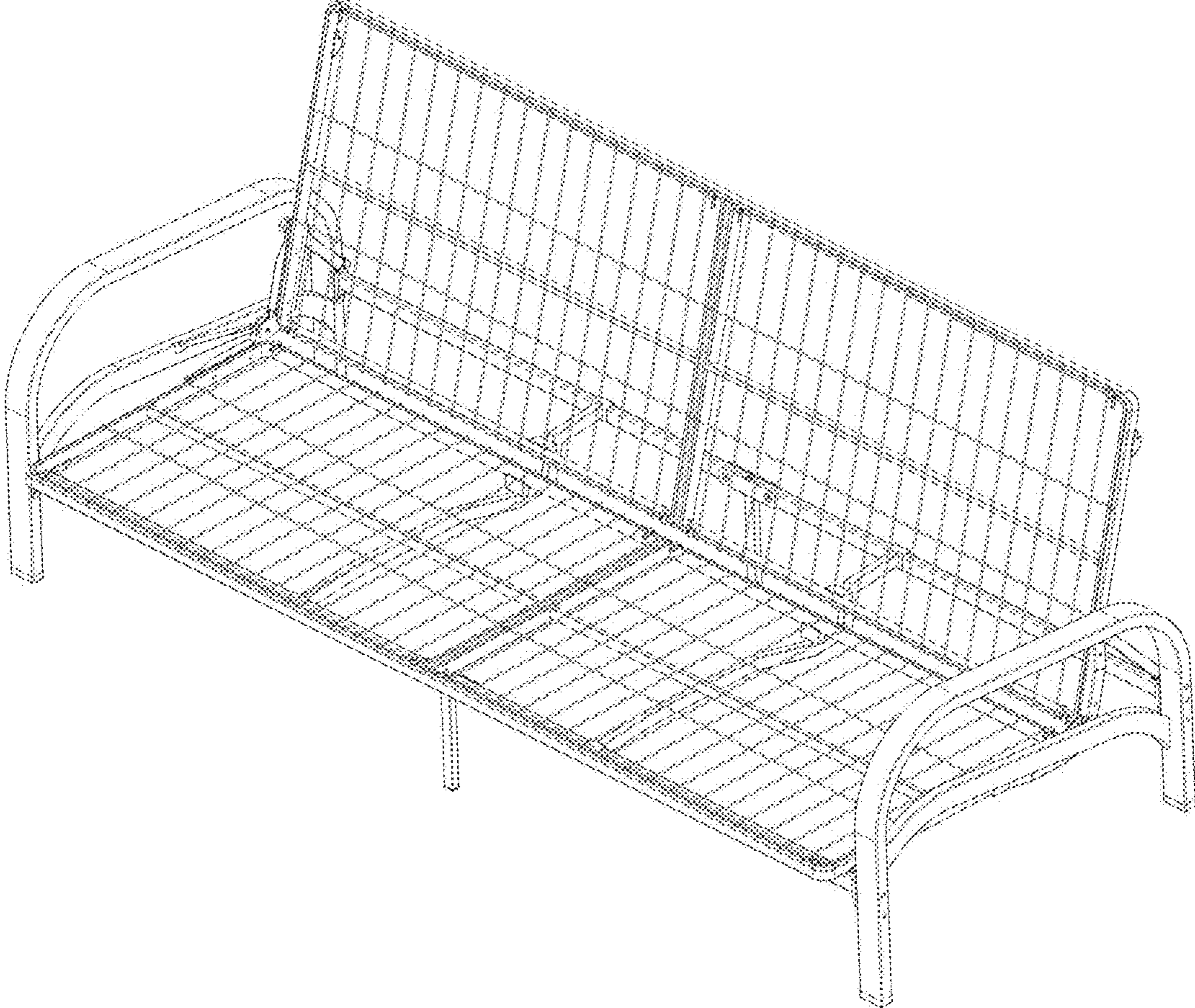

FIG. 1

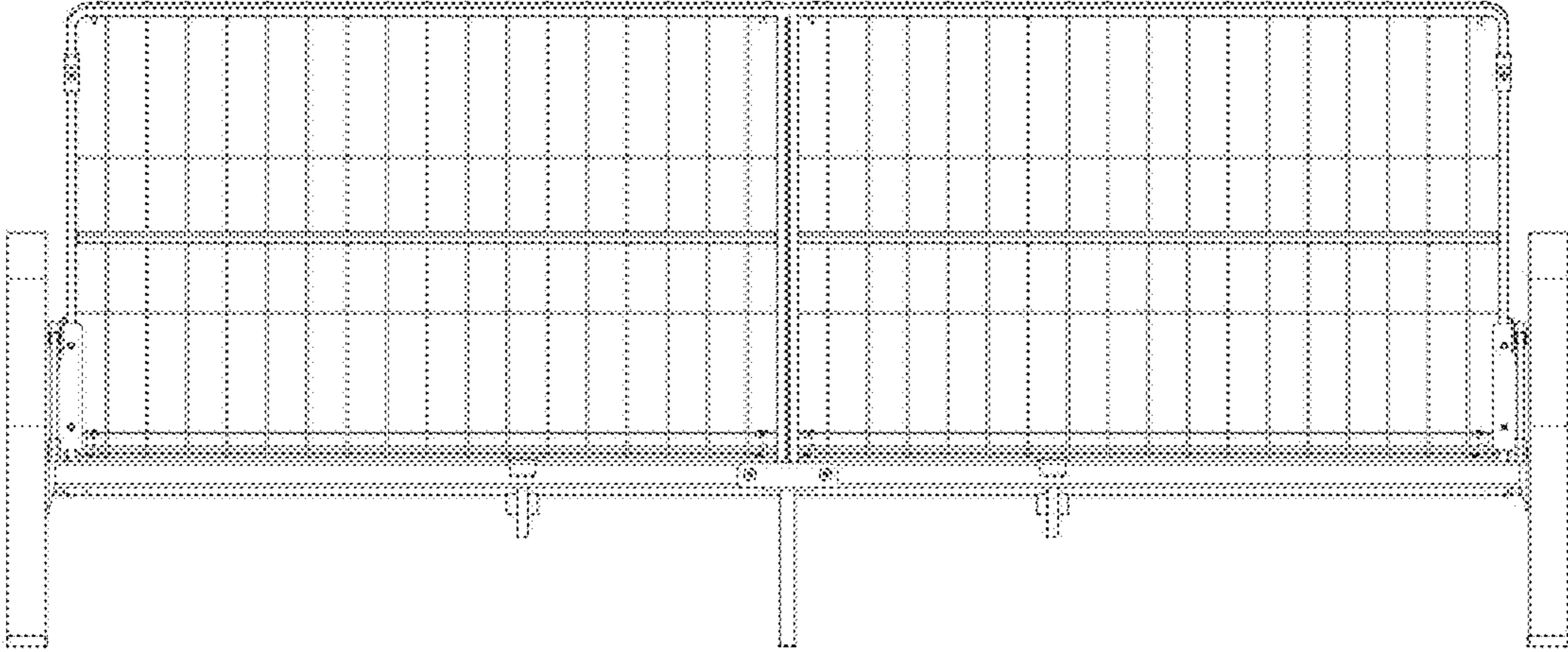

FIG. 2

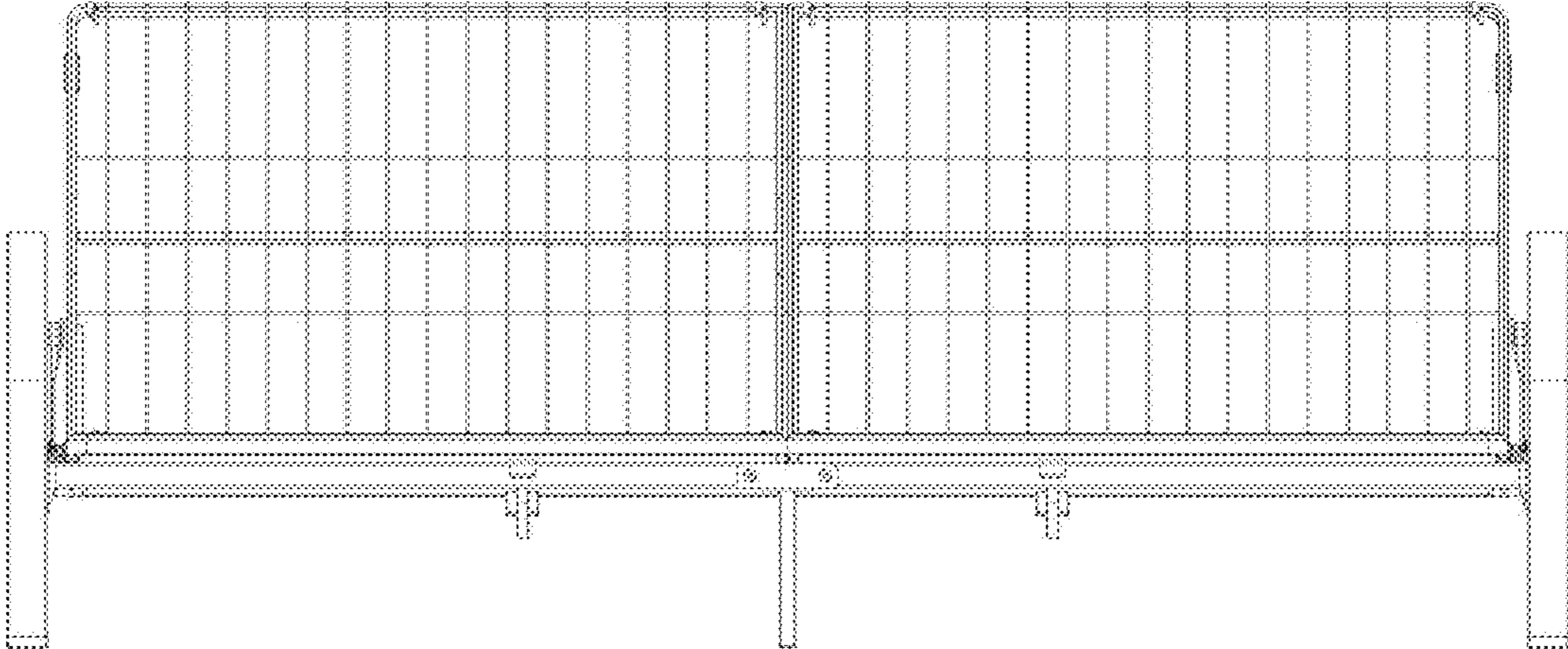

FIG. 3

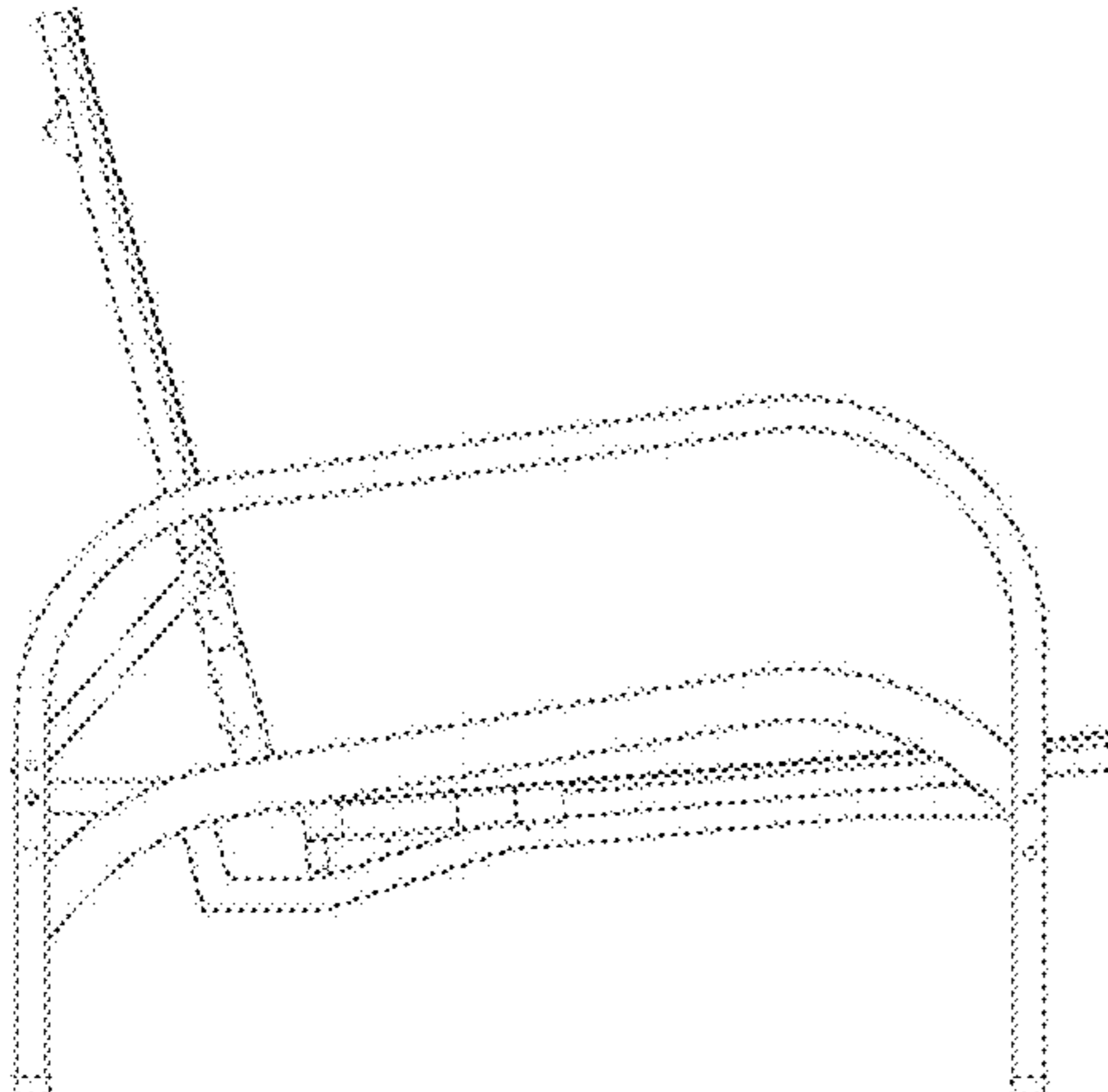

FIG. 4

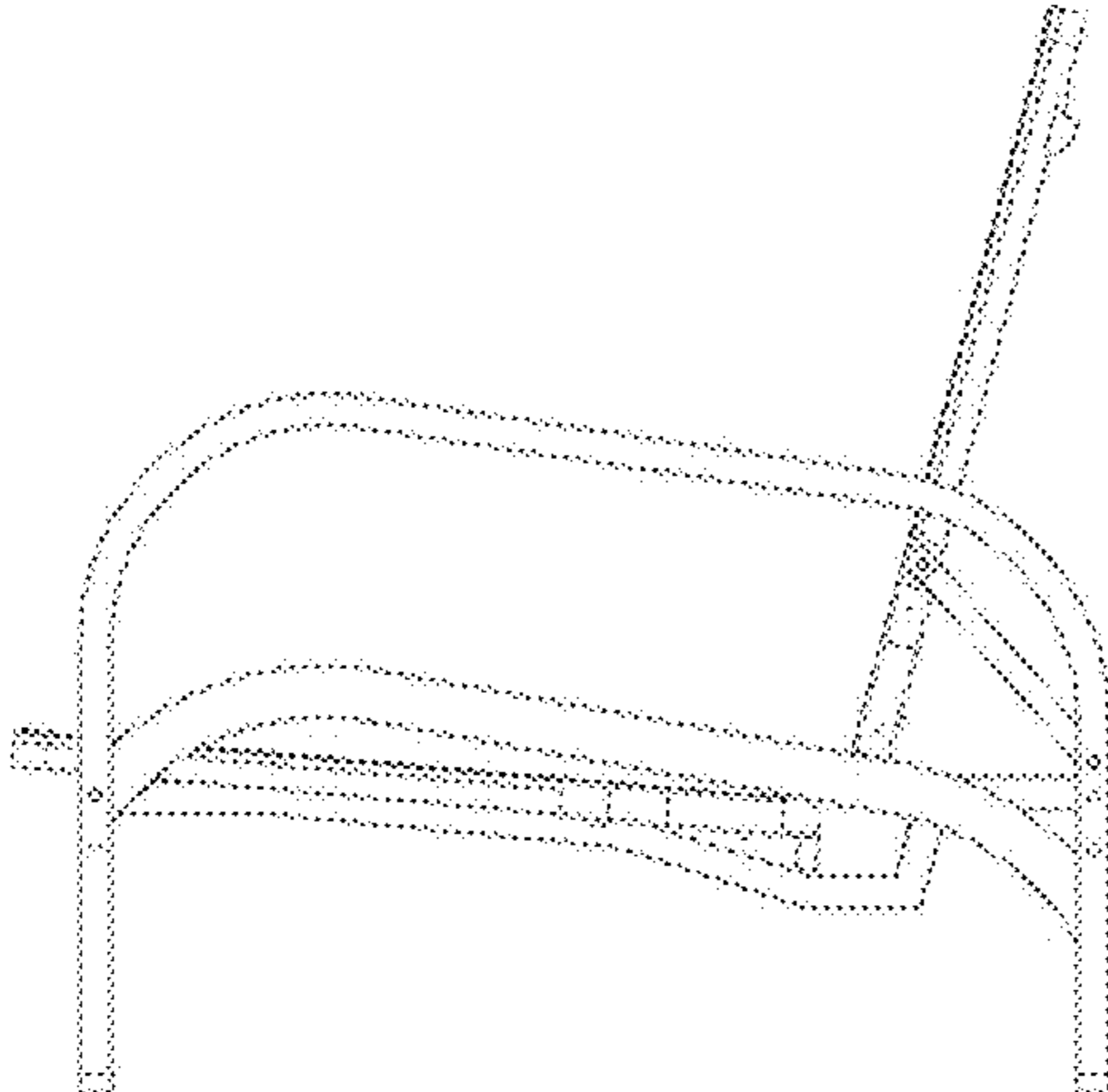

FIG. 5

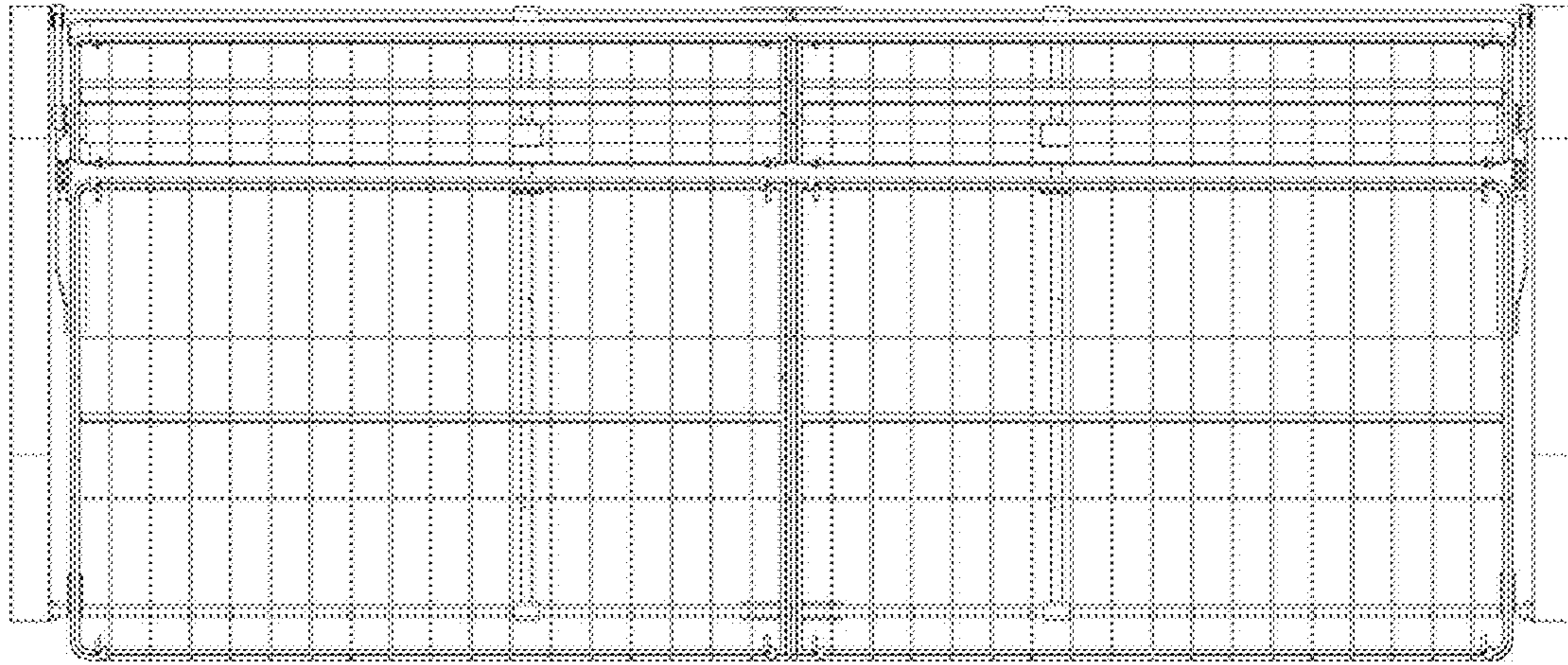

FIG. 6

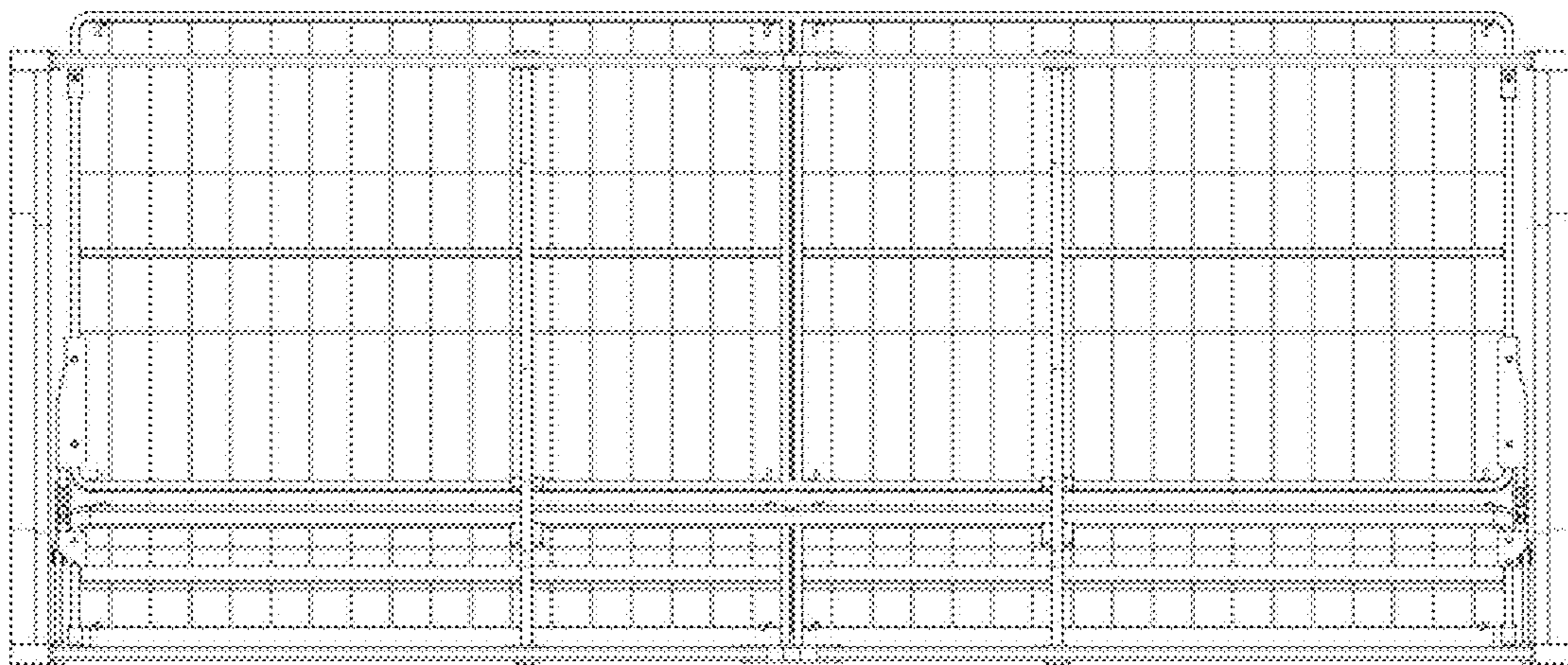

FIG. 7

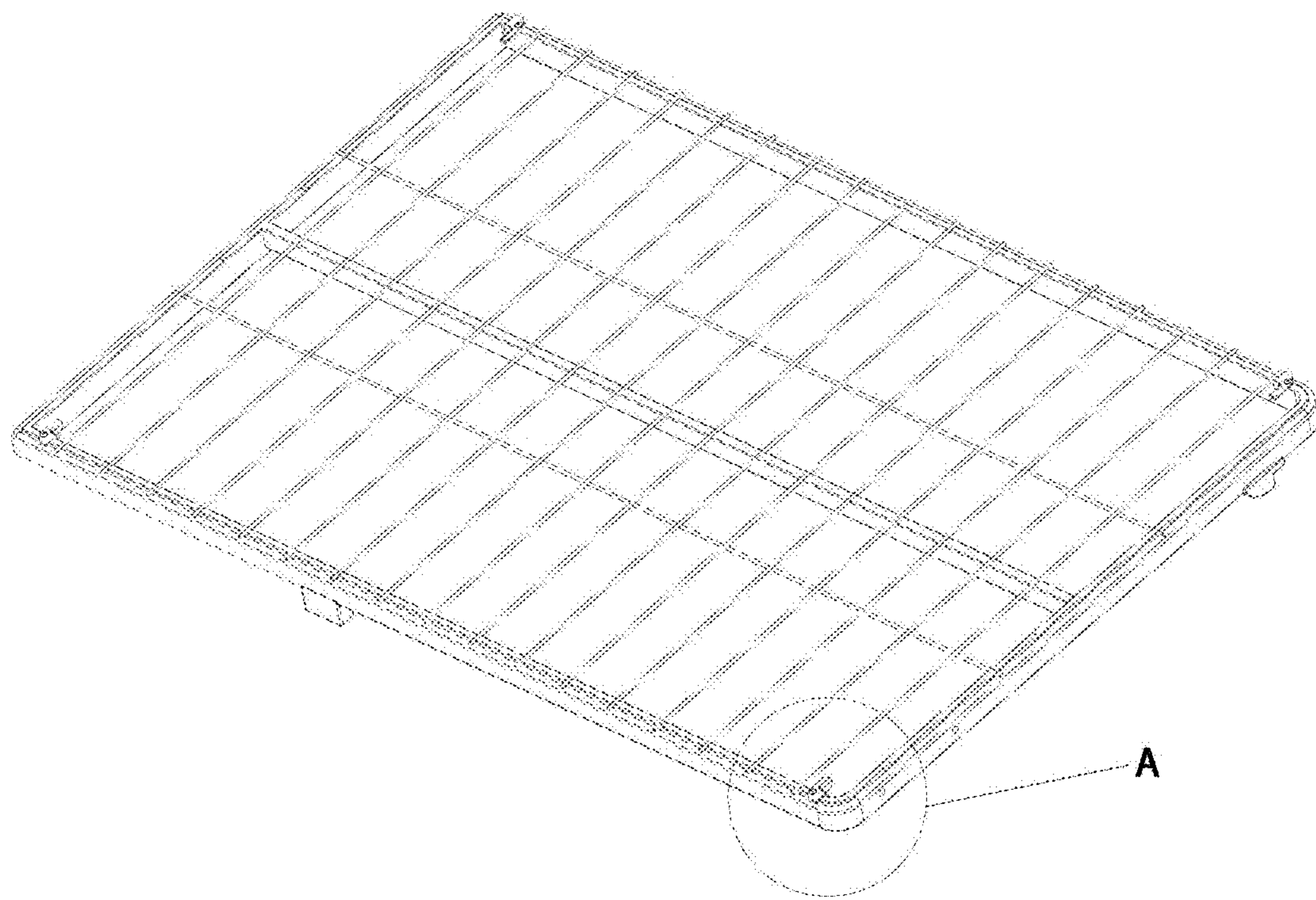

FIG. 8

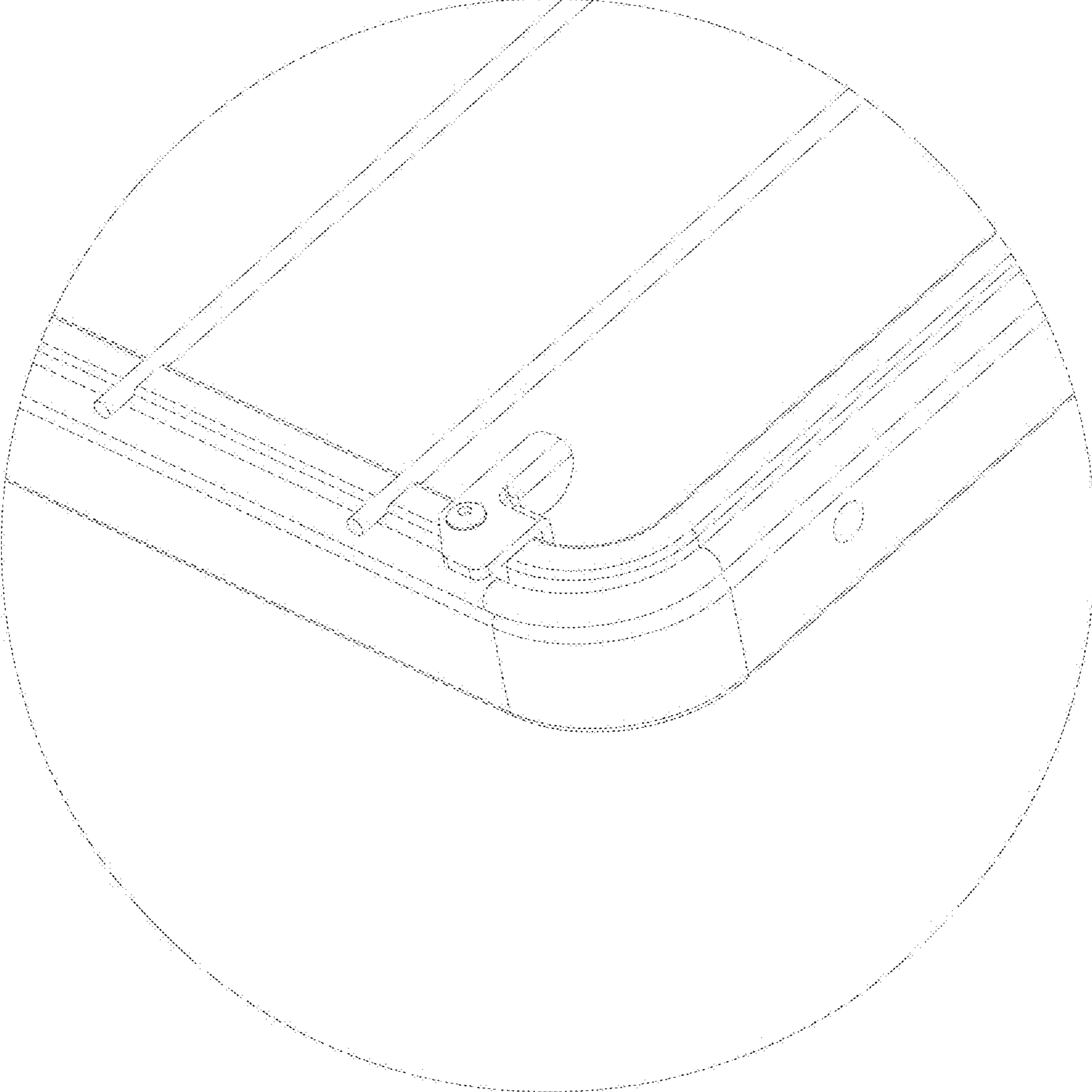

FIG. 9

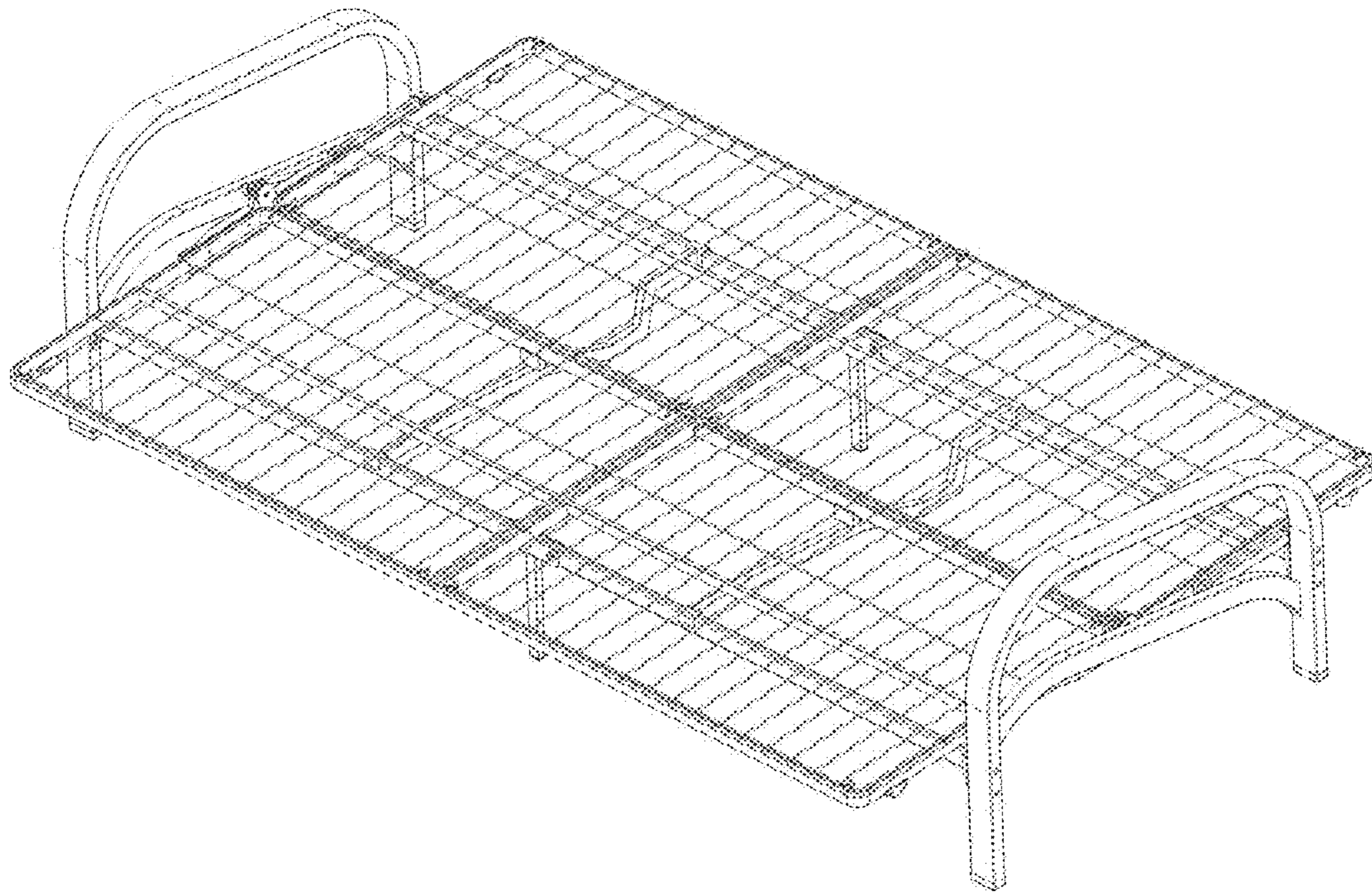

FIG. 10

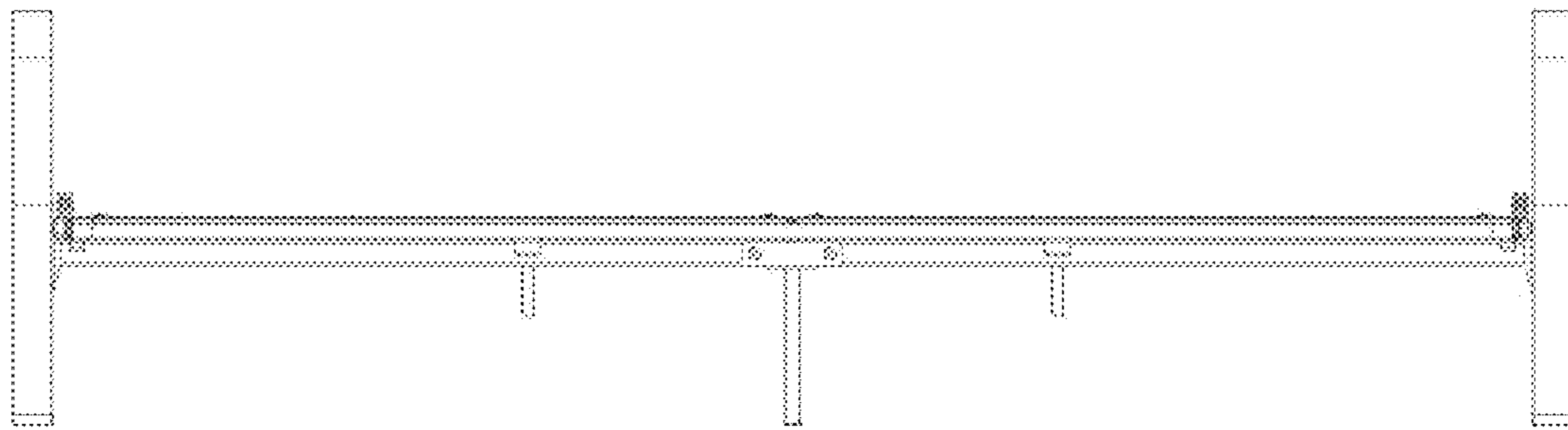

FIG. 11

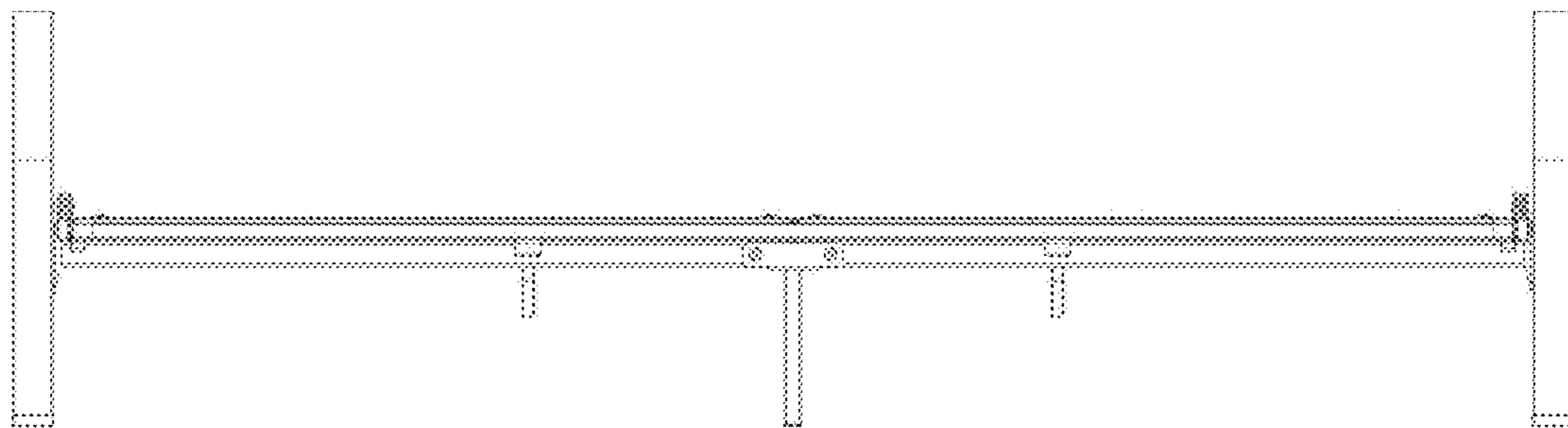

FIG. 12

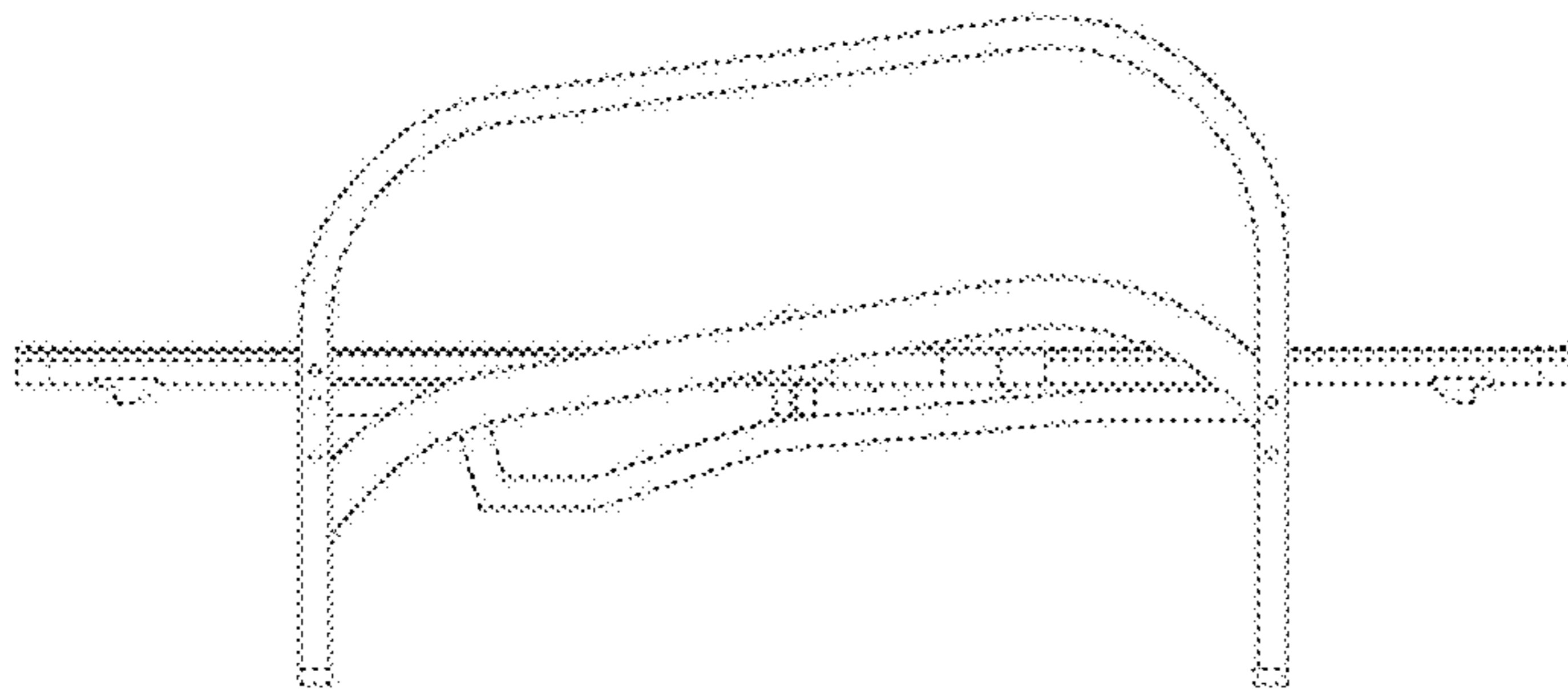

FIG. 13

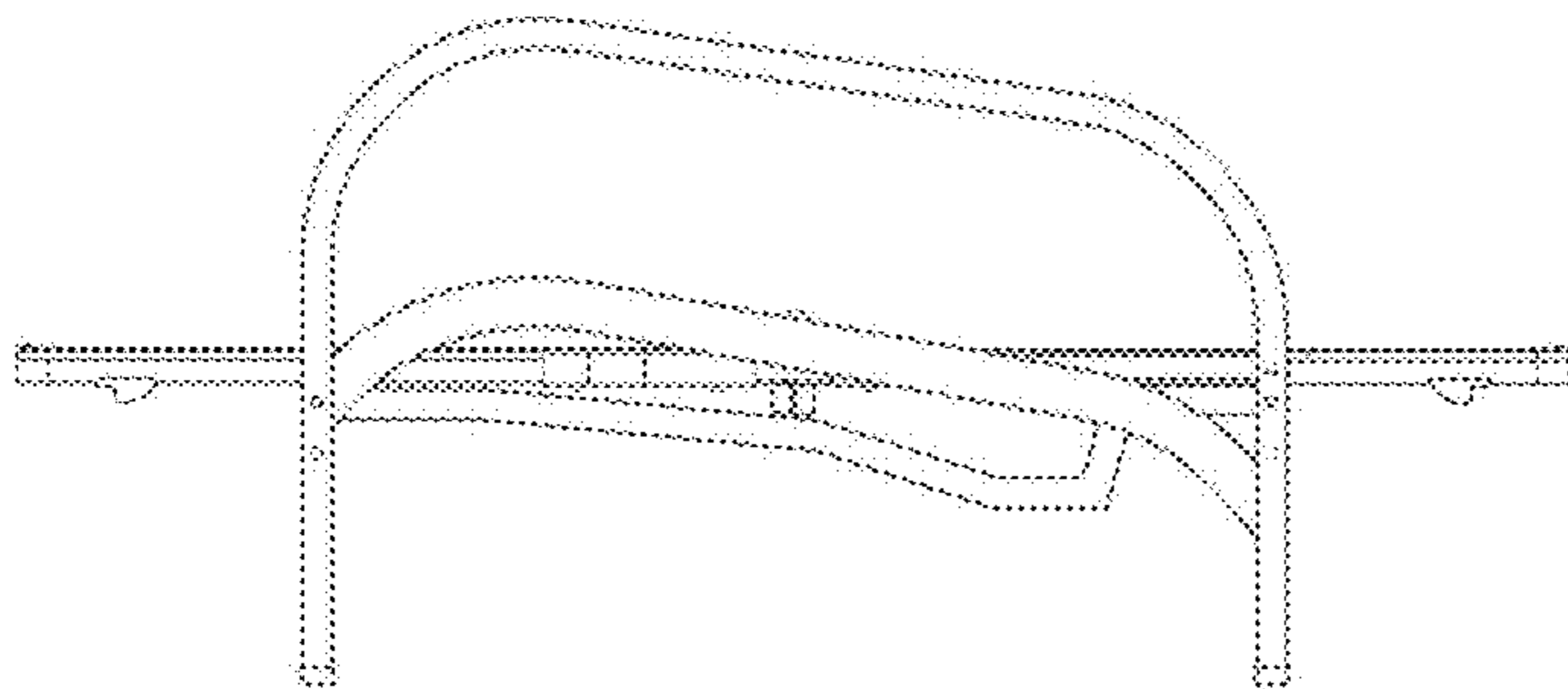

FIG. 14

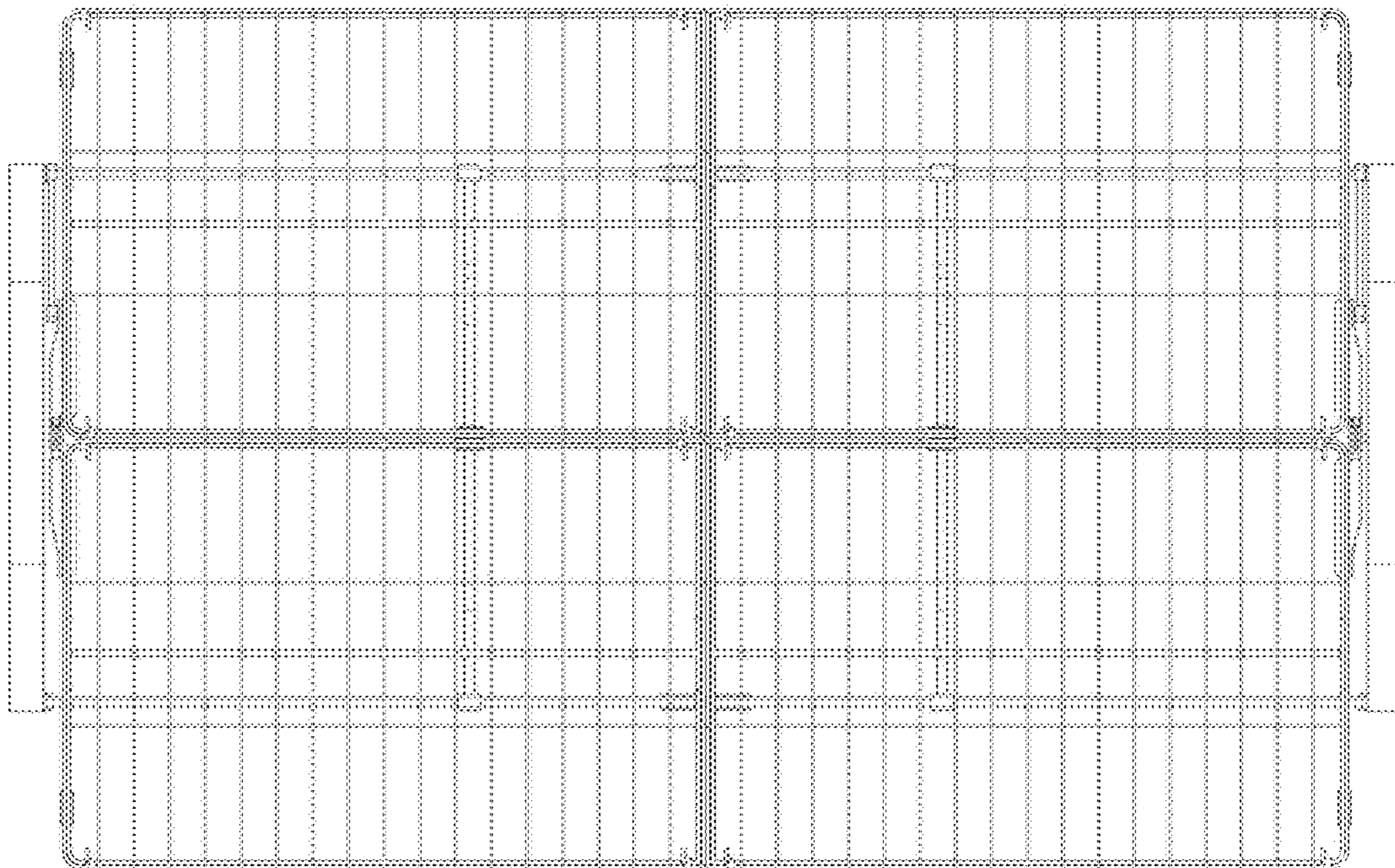

FIG. 15

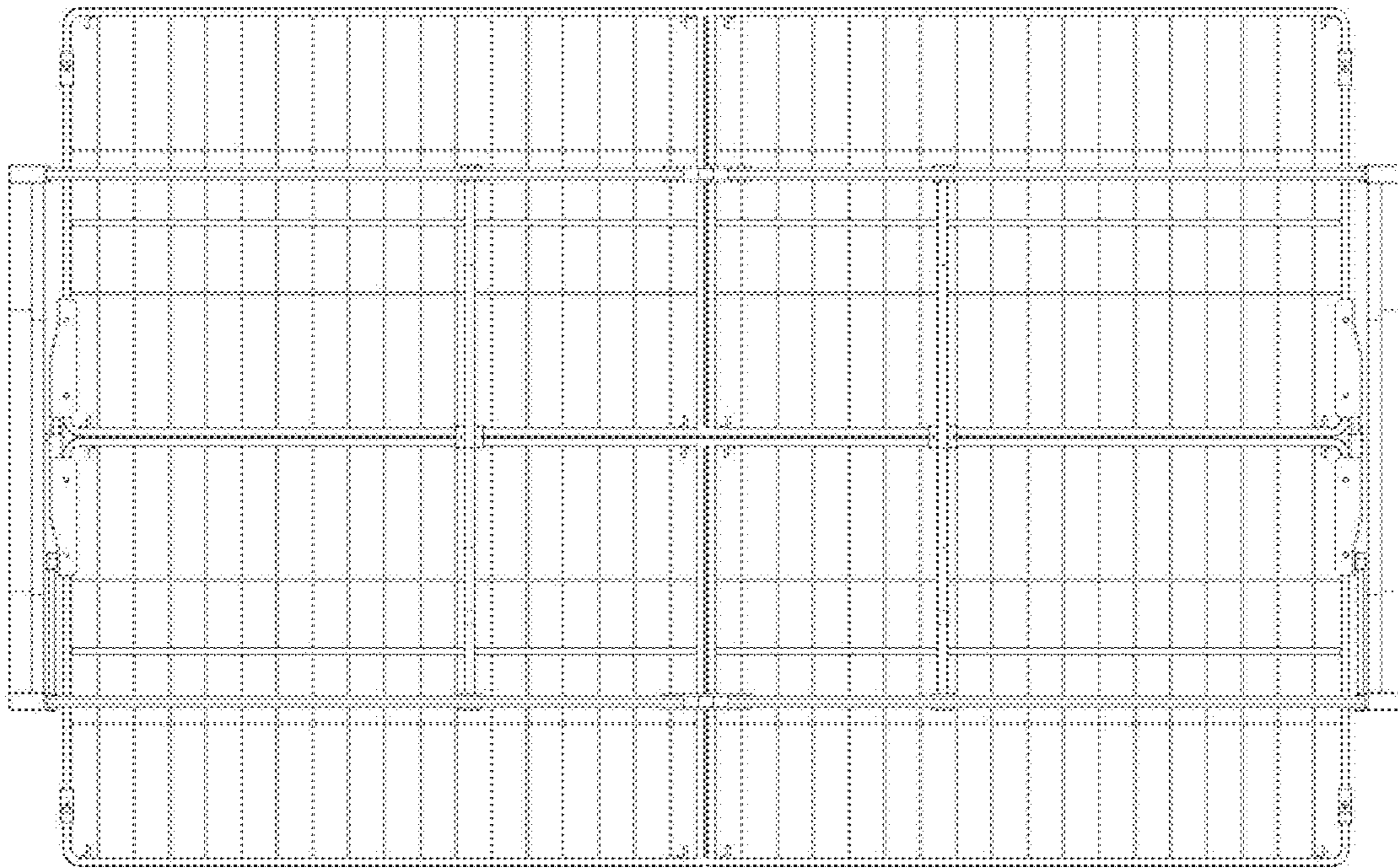

FIG. 16