



US00D976425S

(12) **United States Design Patent**  
**Jin**

(10) **Patent No.:** **US D976,425 S**  
(45) **Date of Patent:** **\*\* Jan. 24, 2023**

(54) **NONINVASIVE BEAUTY MACHINE**

(71) Applicant: **Shenzhen DJ Innovation Industry Co., Ltd, Shenzhen (CN)**

(72) Inventor: **Bo Jin, Shenzhen (CN)**

(\*\*) Term: **15 Years**

(21) Appl. No.: **29/769,753**

(22) Filed: **Feb. 8, 2021**

(30) **Foreign Application Priority Data**

Dec. 29, 2020 (CN) ..... 202030814147.0

(51) **LOC (14) Cl.** ..... **28-03**

(52) **U.S. Cl.**  
USPC ..... **D24/214**

(58) **Field of Classification Search**  
USPC ..... D24/127, 130, 133, 188, 200, 211, 212,  
D24/213, 214, 215; D28/44, 56, 58;  
D10/57; D14/218; D30/158; D23/303  
CPC ..... A61H 7/00; A61H 1/00; A61H 2205/00;  
A61B 10/04; A61N 5/0616; A61N  
2005/0644; A61N 2005/0643; A61N  
1/328

See application file for complete search history.

(56) **References Cited**

**U.S. PATENT DOCUMENTS**

D540,947 S \* 4/2007 Jung ..... D24/209  
D603,970 S \* 11/2009 Ball ..... D24/209  
D652,514 S \* 1/2012 Sherwood ..... D24/133  
D742,003 S \* 10/2015 Tasar ..... D24/146  
D850,638 S \* 6/2019 Cha ..... D24/200  
D888,264 S \* 6/2020 Sherrill ..... D24/215  
D899,616 S \* 10/2020 Jung ..... D24/215  
D903,866 S \* 12/2020 Chen ..... D24/144  
D914,898 S \* 3/2021 Britt ..... D24/214  
D917,695 S \* 4/2021 Babic ..... D24/144  
D942,029 S \* 1/2022 Wang ..... D24/214

D948,039 S \* 4/2022 Dastmalchi ..... D24/133  
D948,789 S \* 4/2022 Huang ..... D24/214  
D949,358 S \* 4/2022 Peterson ..... D24/211  
D949,415 S \* 4/2022 Khubani ..... D24/215  
D950,754 S \* 5/2022 Khubani ..... D24/215  
D956,986 S \* 7/2022 Cai ..... D24/200

**OTHER PUBLICATIONS**

Blason, "Meso Injet Needle Free", Access Date Aug. 8, 2022. <https://www.blasononline.com/BlasonOnline/spa-equipment/mesotherapy-needle-free/meso-injet-needle-free-ref-1422-detail>. Shown on pp. 1 and 2. (Year: 2022).\*

Amazon, "EMS Beauty Machine", Date First Available Sep. 21, 2019. <https://www.amazon.ae/Microneedle-Mesotherapy-Injection-Tightening-Rejuvenation/dp/B07Y65SGRD>. Shown on p. 1. (Year: 2019).\*

\* cited by examiner

*Primary Examiner* — Michael A Maharajh

(74) *Attorney, Agent, or Firm* — Rumit R. Kanakia

(57) **CLAIM**

The ornamental design for a noninvasive beauty machine, as shown and described.

**DESCRIPTION**

FIG. 1 is a first perspective view of a noninvasive beauty machine showing my new design;  
FIG. 2 is a second perspective view thereof;  
FIG. 3 is a front view thereof;  
FIG. 4 is a back view thereof;  
FIG. 5 is a left side view thereof;  
FIG. 6 is a right side view thereof;  
FIG. 7 is a top view thereof; and,  
FIG. 8 is a bottom view thereof.

The broken lines shown in the drawings depict portions of the noninvasive beauty machine in which the design is embodied that form no part of the claimed design.

**1 Claim, 8 Drawing Sheets**

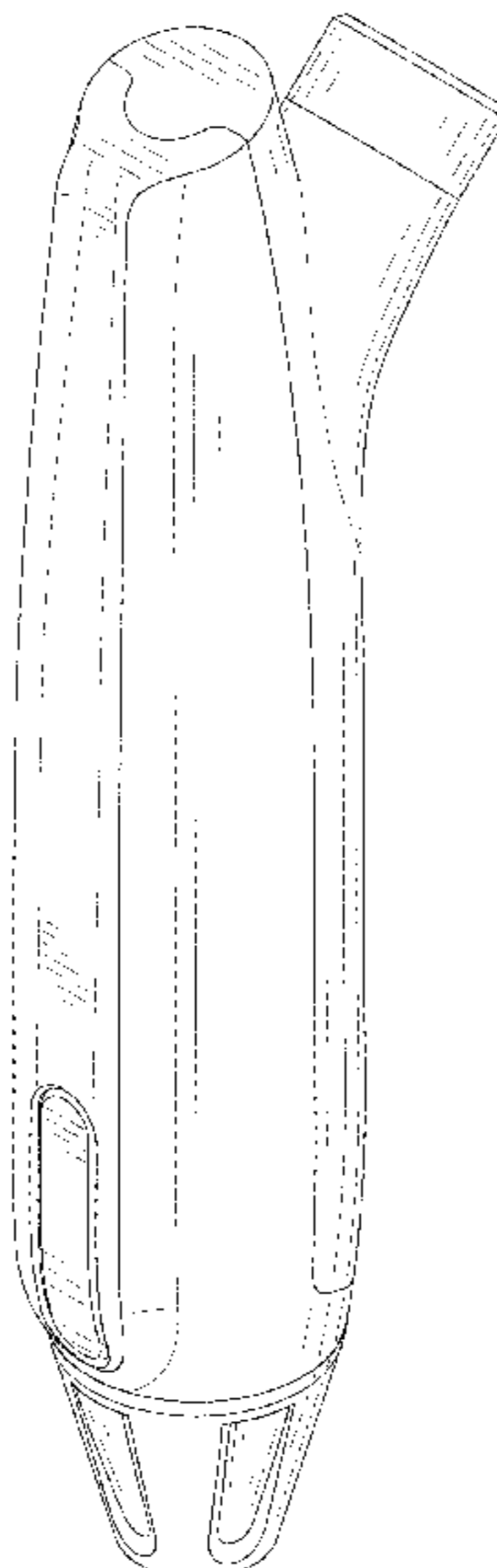

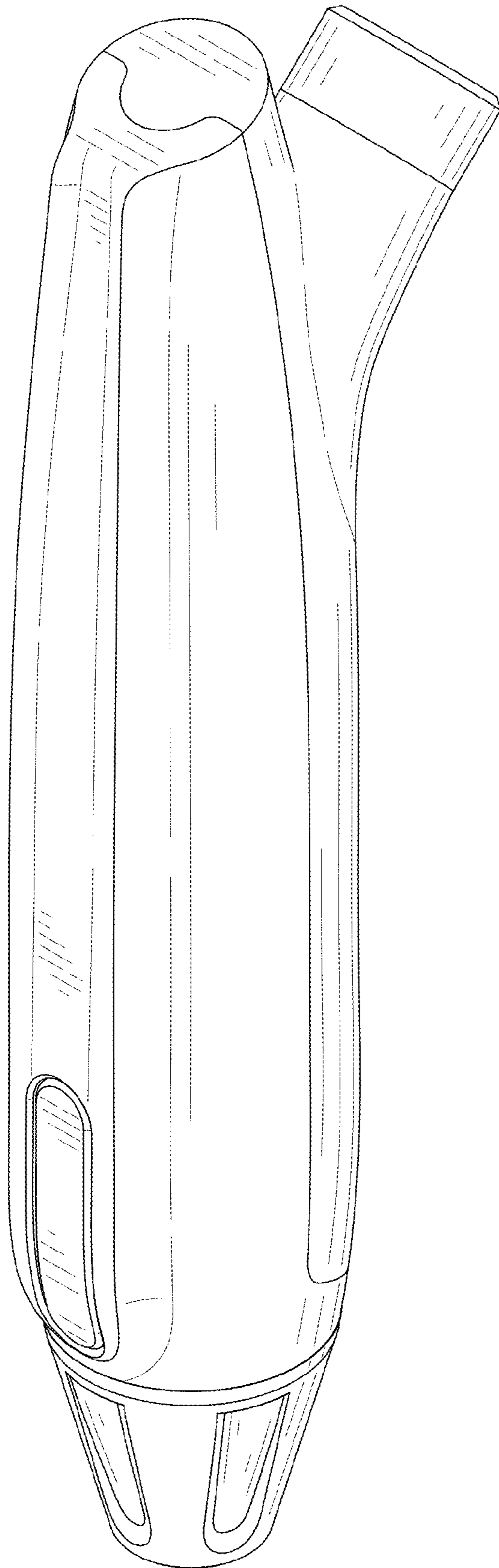

FIG. 1

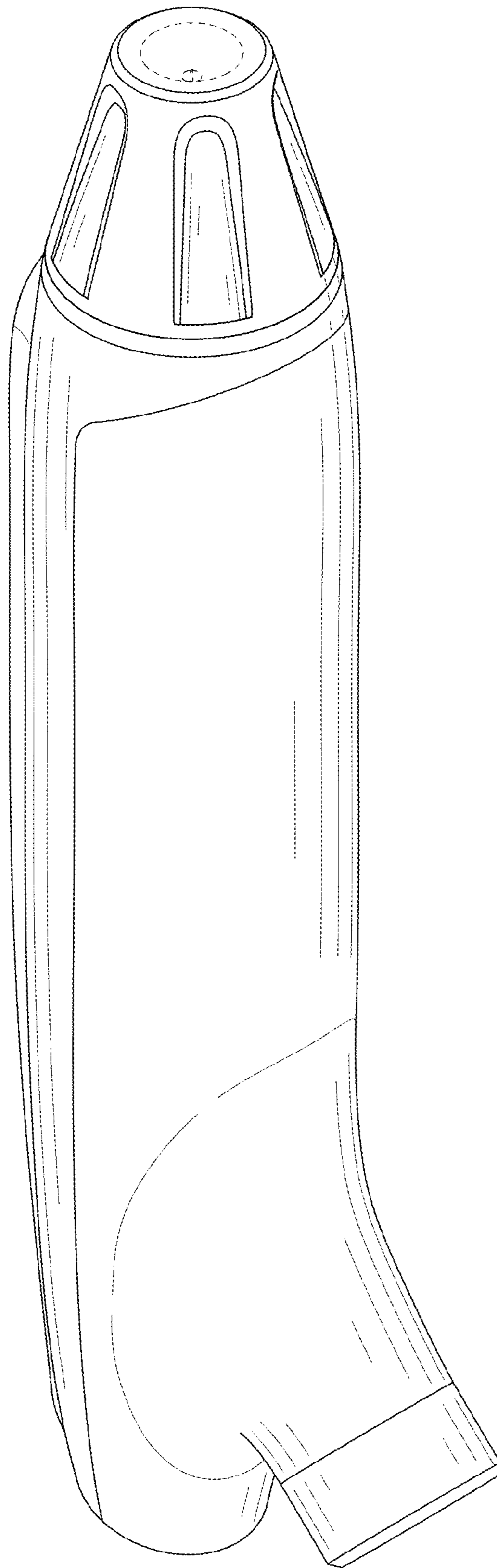

FIG. 2

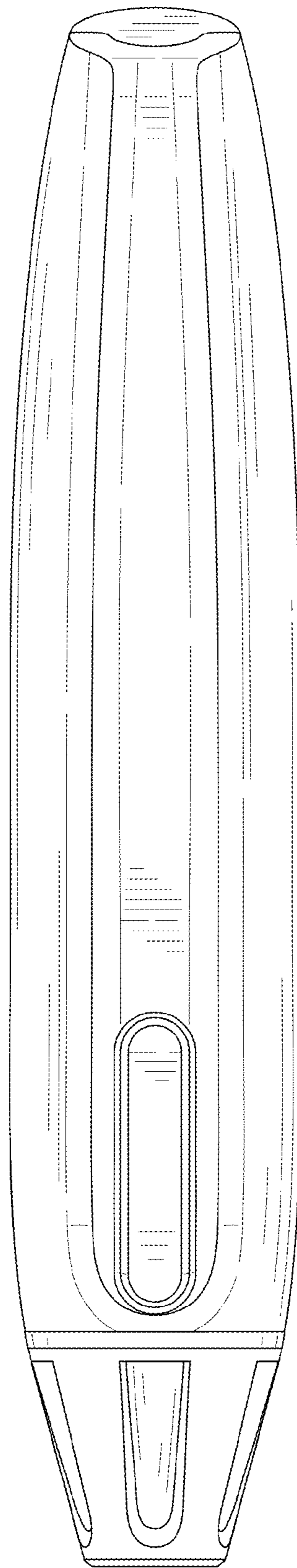

FIG. 3

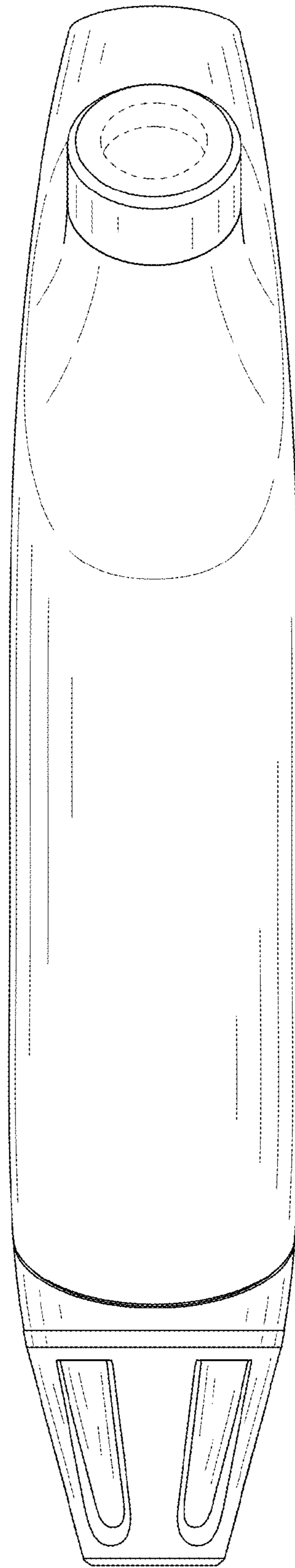

FIG. 4

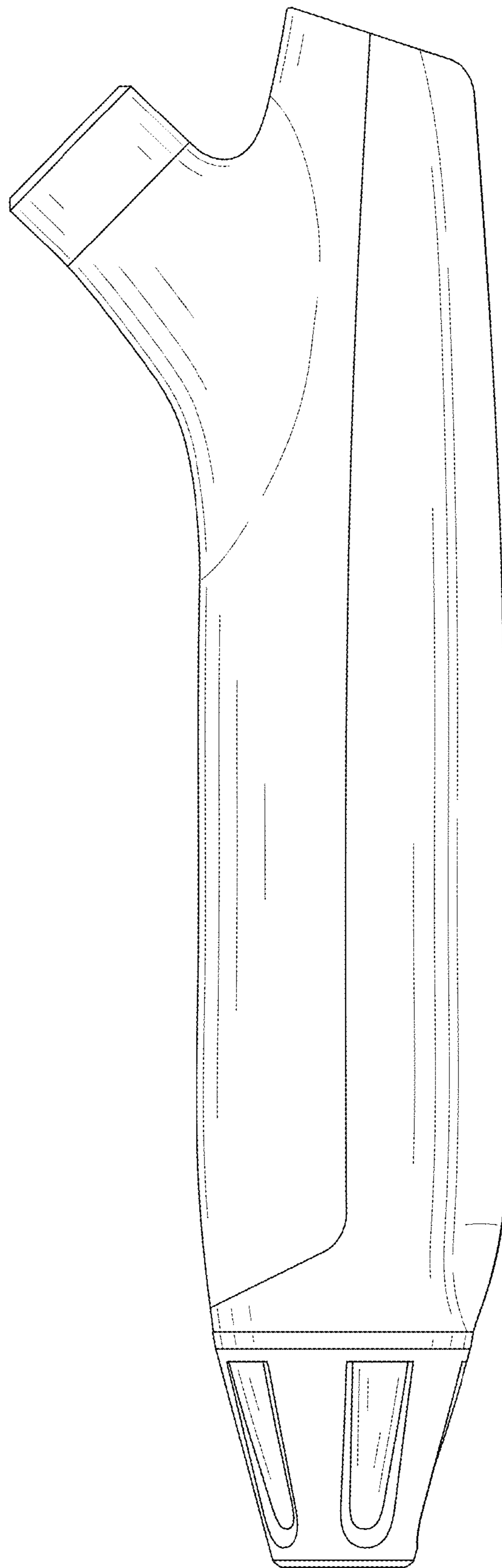

FIG. 5

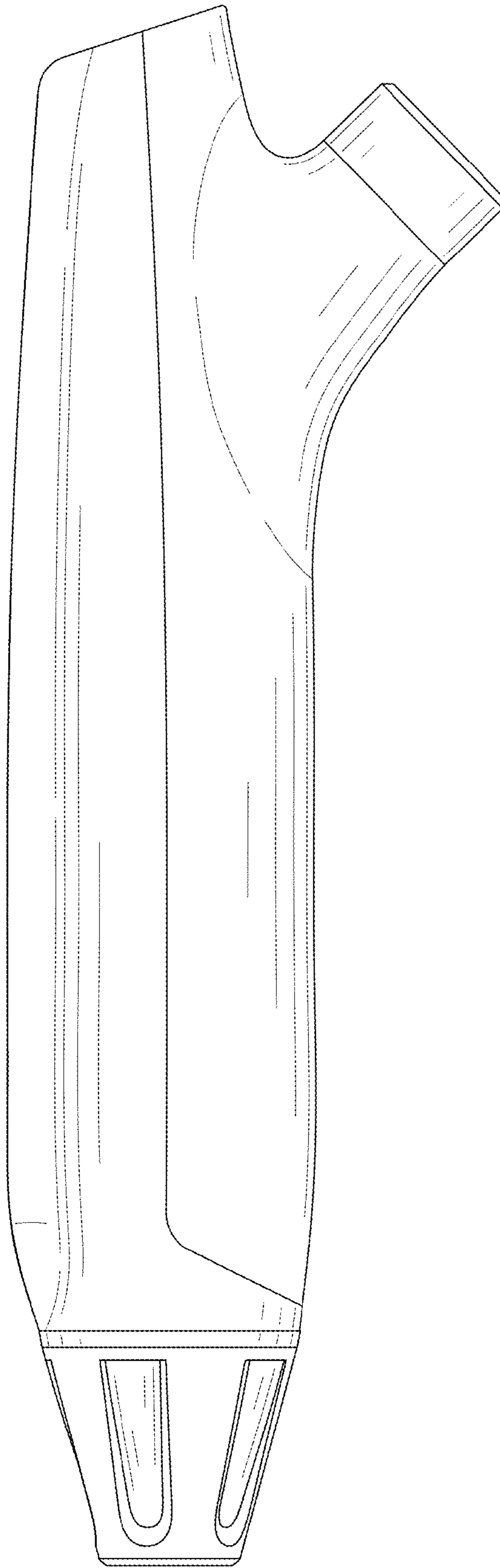

FIG. 6

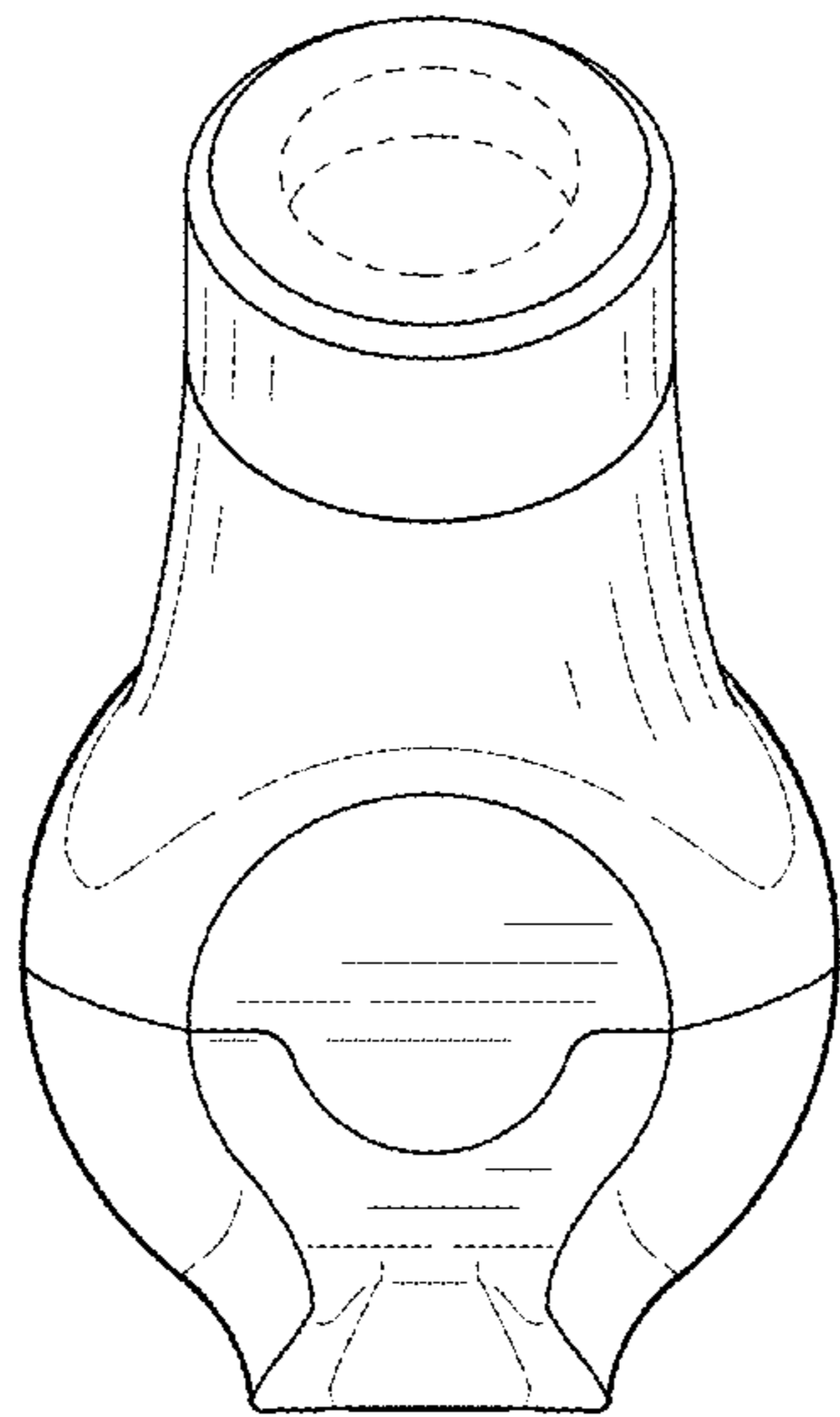

FIG. 7



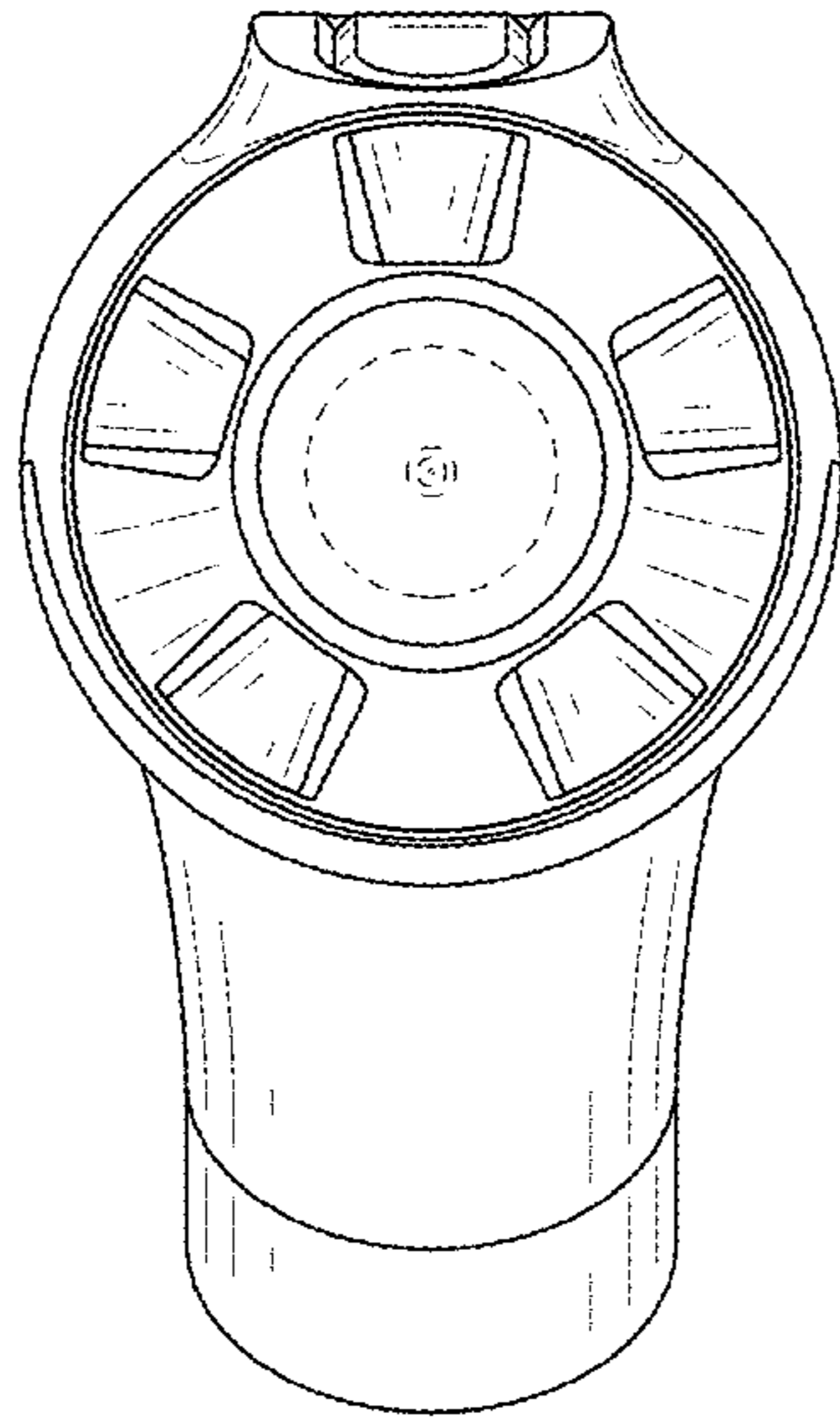

FIG. 8