



US00D976420S

(12) **United States Design Patent** (10) **Patent No.:** **US D976,420 S**
Munoz et al. (45) **Date of Patent:** **** Jan. 24, 2023**

(54) **HANDS-FREE BOTTLE HOLDER**
(71) Applicant: **CANELA CANE, LLC**, Mooresville, NC (US)
(72) Inventors: **Daniel Munoz**, Mooresville, NC (US); **David Stephen Kendall**, Austin, TX (US); **Parker Dahl**, Mendon, UT (US)
(73) Assignee: **Canela Cane, LLC**, Mooresville, NC (US)
(**) Term: **15 Years**
(21) Appl. No.: **29/795,513**
(22) Filed: **Jun. 18, 2021**
(51) **LOC (14) Cl.** **07-01**
(52) **U.S. Cl.**
USPC **D24/199**
(58) **Field of Classification Search**
USPC D24/194, 195, 196, 197, 198, 199;
D7/392.1, 511, 513, 619.1, 622, 624.2;
D9/523, 530, 531, 537, 548, 719, 741,
D9/745
CPC .. A61J 9/0676; A61J 9/00; A61J 9/005; A61J
9/008; A61J 9/08; A47J 36/2411
See application file for complete search history.

D440,760 S * 4/2001 Joseph D3/218
D597,402 S * 8/2009 Garza D8/380
D624,807 S * 10/2010 Barrese D8/373
D635,407 S * 4/2011 Ceder D7/622
(Continued)

OTHER PUBLICATIONS

“Beebo: Hands-Free Bottle Holder”. Found online Jul. 12, 2016 at odditymall.com. Reference dated Jun. 2, 2015. Retrieved from <http://odditymall.com/beebo-hands-free-baby-bottle-holder>.
(Continued)

Primary Examiner — Kendra Leslie Hamilton
(74) *Attorney, Agent, or Firm* — Thompson Hine LLP

(57) **CLAIM**

The ornamental design for a hands-free bottle holder, as shown and described.

DESCRIPTION

FIG. 1 is a perspective view of a hands-free bottle holder showing a new design;
FIG. 2 is a left side view of the hands-free bottle holder of FIG. 1;
FIG. 3 is a right side view of the hands-free bottle holder of FIG. 1;
FIG. 4 is a front view of the hands-free bottle holder of FIG. 1;
FIG. 5 is a rear view of the hands-free bottle holder of FIG. 1;
FIG. 6 is a top view of the hands-free bottle holder of FIG. 1; and,
FIG. 7 is a bottom view of the hands-free bottle holder of FIG. 1.
The broken lines in the drawings depict portions of the hands-free bottle holder that form no part of the claimed design.

1 Claim, 5 Drawing Sheets

(56) **References Cited**

U.S. PATENT DOCUMENTS

2,218,311 A * 10/1940 Elliott A61J 9/0661
5/503.1
2,907,539 A 10/1959 Vardan
3,850,393 A * 11/1974 Marquard A61J 9/0676
248/102
D290,794 S * 7/1987 Mingledorff, Jr. D24/199
D299,750 S * 2/1989 Garcia D24/199
D309,018 S * 7/1990 Leach D24/199
D382,970 S * 8/1997 Agopian D24/199
5,704,505 A * 1/1998 Singh A61J 9/06
248/104
D417,778 S * 12/1999 Karlin, III D3/229

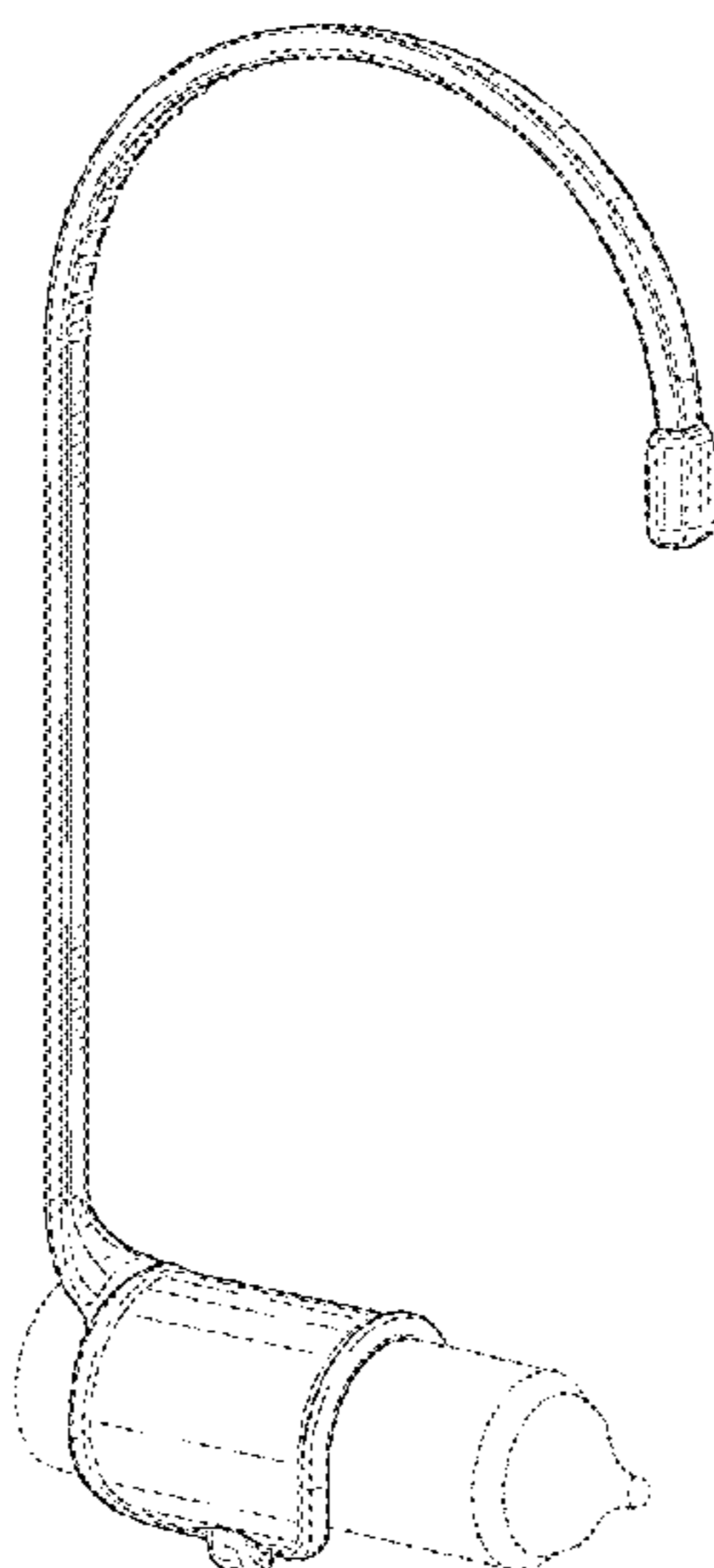

(56)

References Cited

U.S. PATENT DOCUMENTS

D743,043 S * 11/2015 Cao D24/215

OTHER PUBLICATIONS

“Handy: Hands-Free Bottle Holder”. Found online Jul. 12, 2016 at amazon.com. Reference dated Nov. 5, 2012. Retrieved from <https://www.amazon.com/Handy-Bottle-Holder/dp/B009UZN1R0/>.*

“Li'l Helper: Bottle Holder”. Found online Jul. 12, 2016 at babycenter.com. Reference dated Nov. 7, 2012. Retrieved from http://blogs.babycenter.com/products_and_prizes/lil-helper-bottle-holder-yay-ornay/.*

“Mace Corp: Bottle Holder Structure”. Found online Mar. 2, 2018 at youtube.com. Reference dated Oct. 13, 2016. Retrieved from <https://www.youtube.com/watch?v=2fh31dE3lxY>.*

* cited by examiner

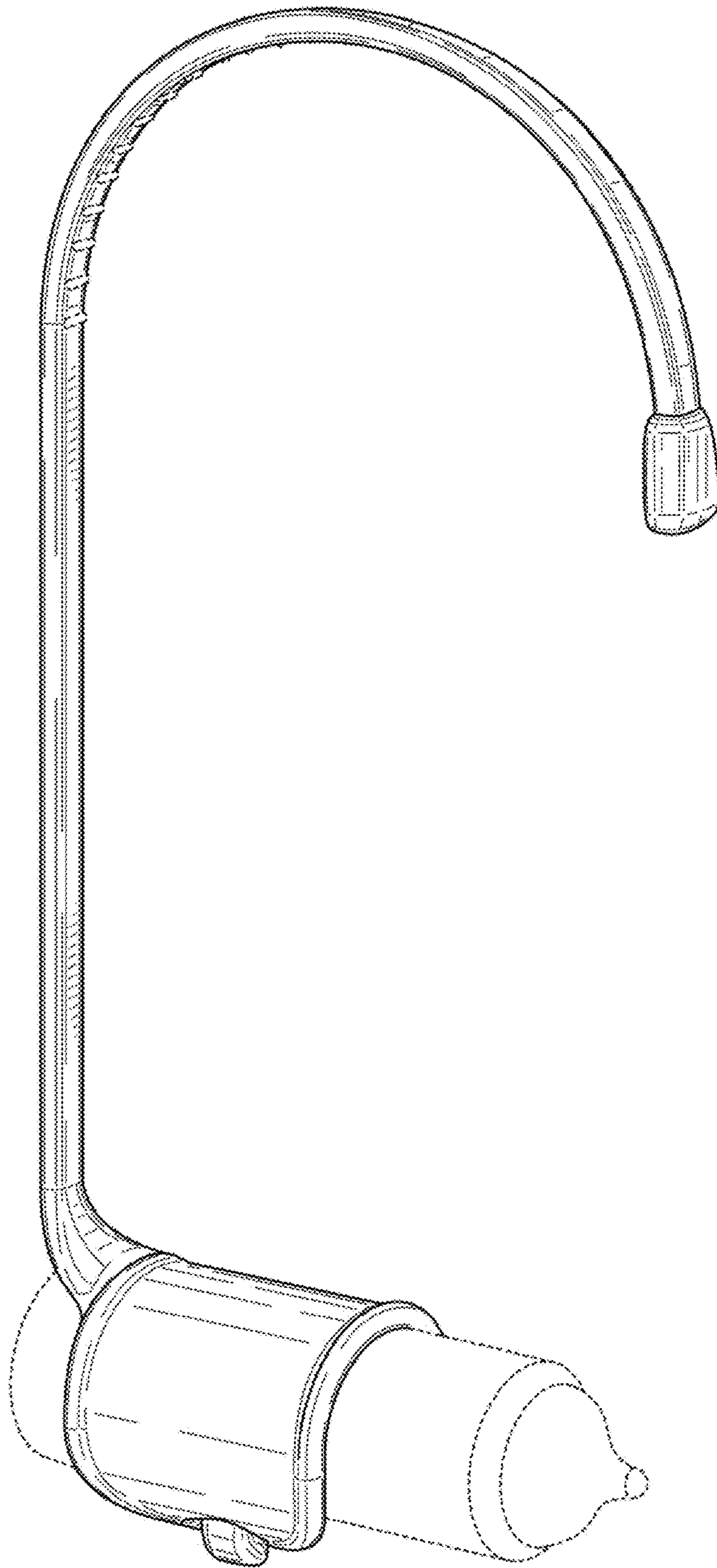

FIG. 1

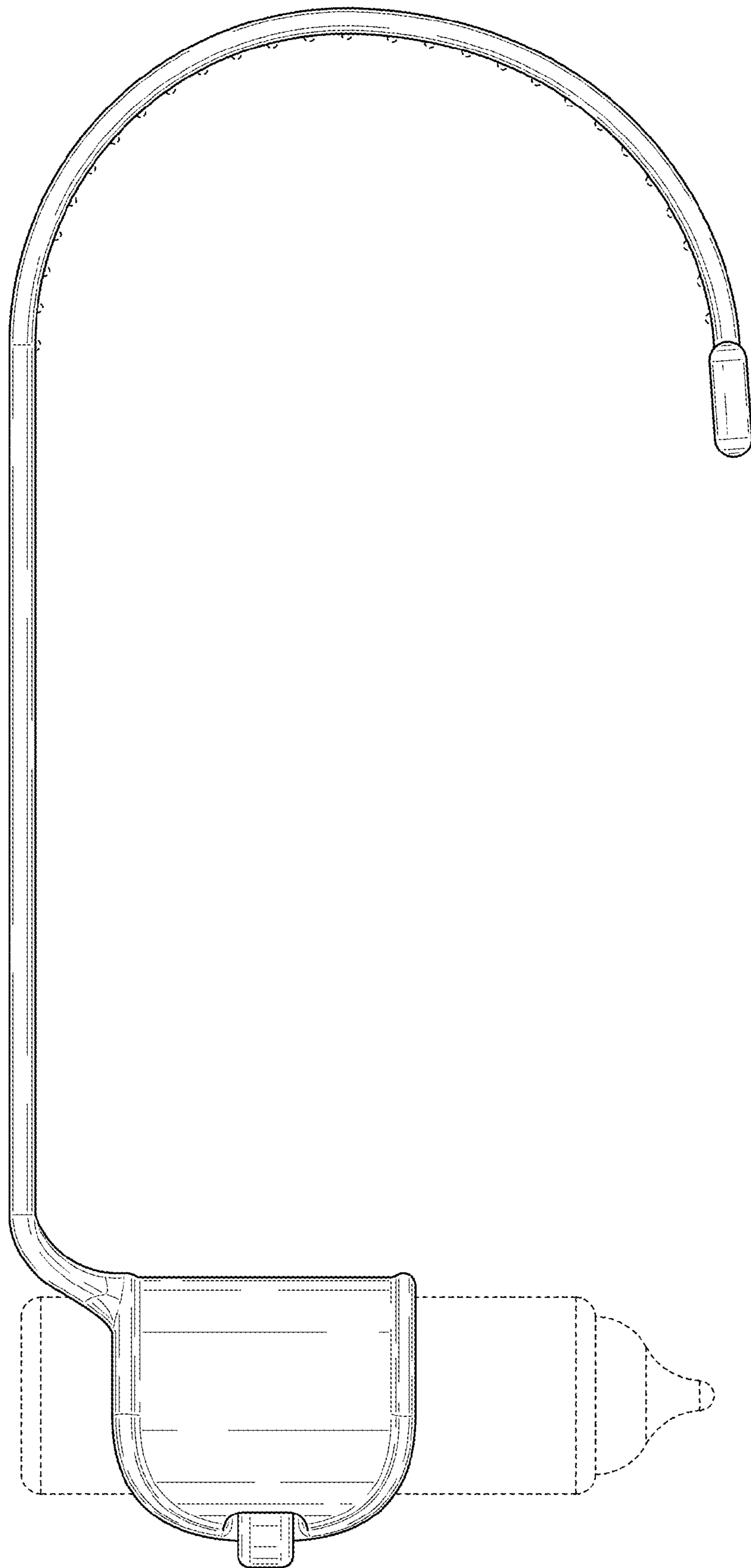

FIG. 2

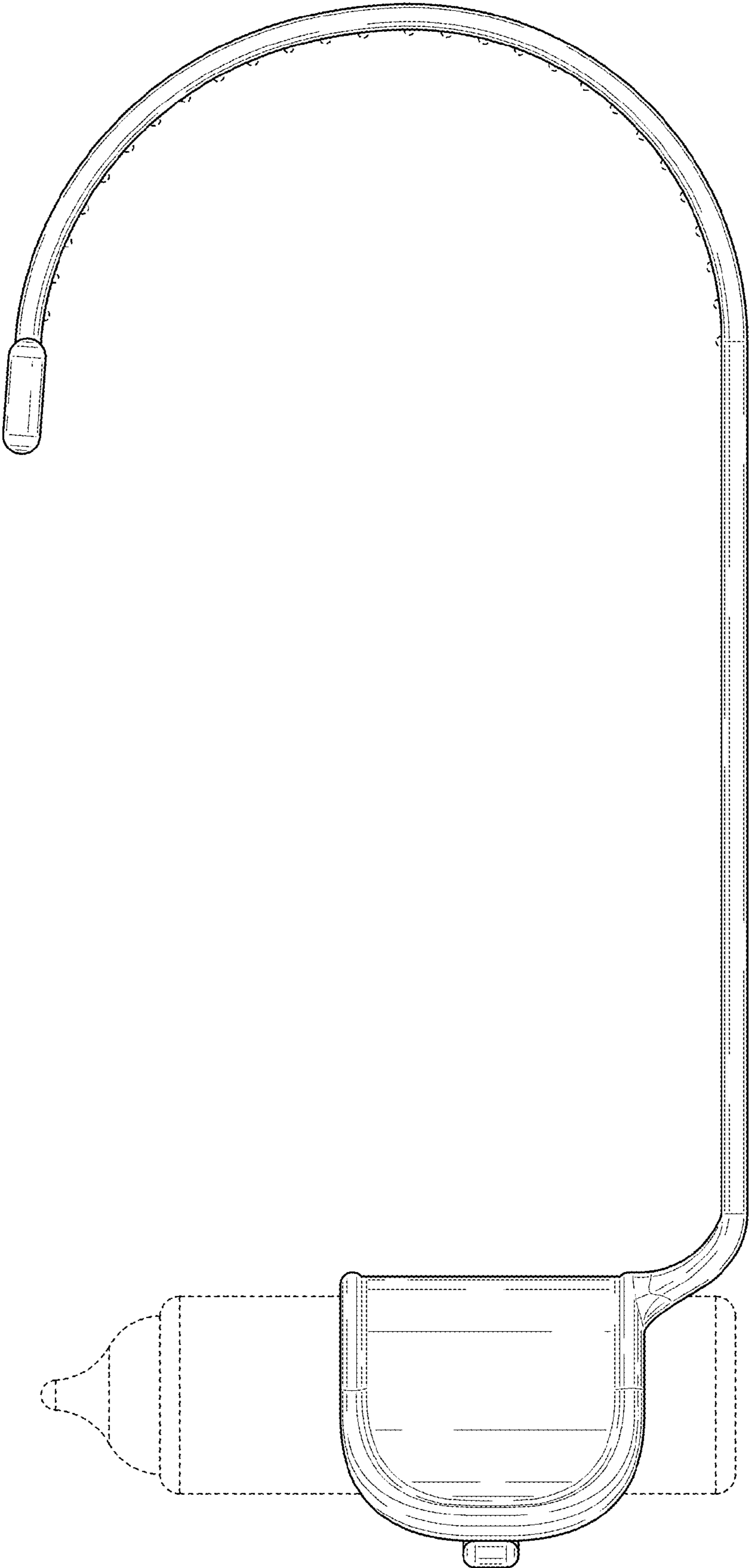

FIG. 3

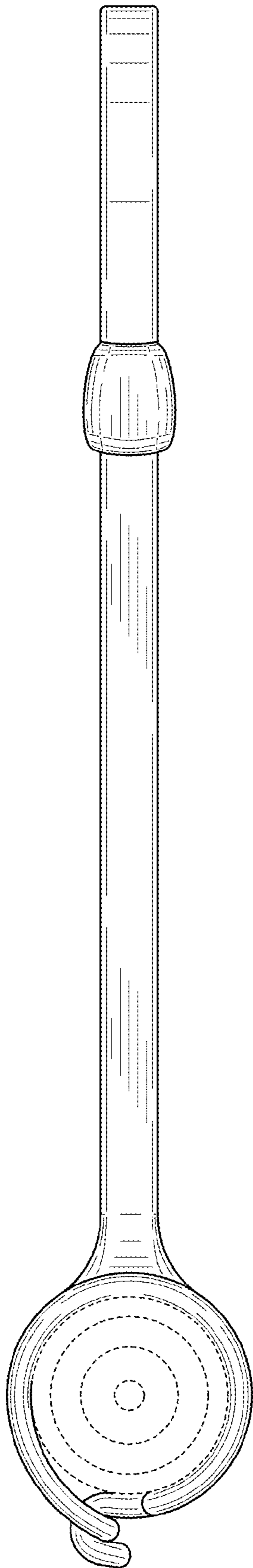

FIG. 4

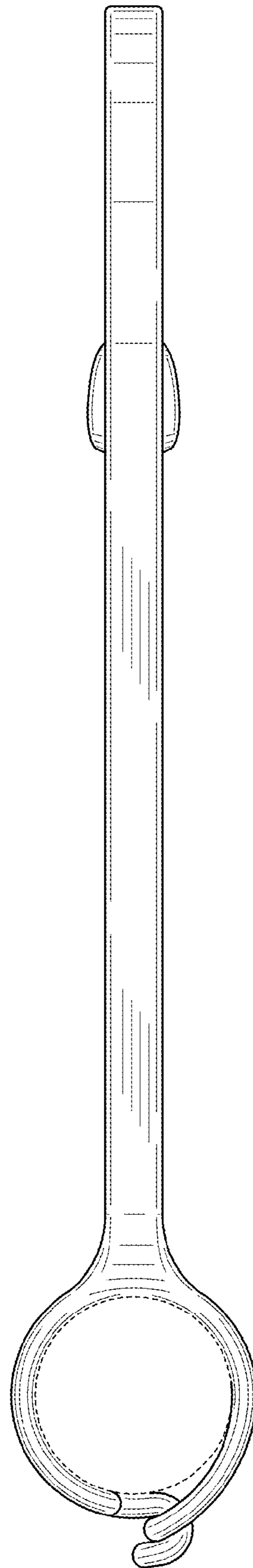

FIG. 5

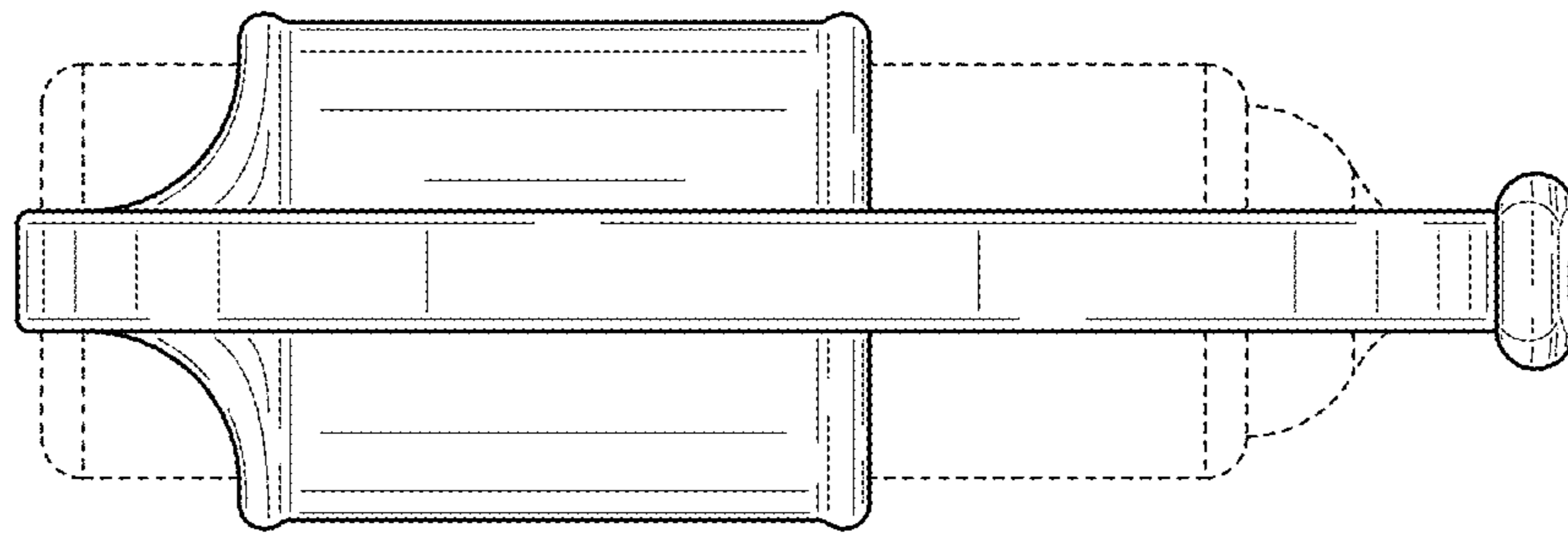

FIG. 6

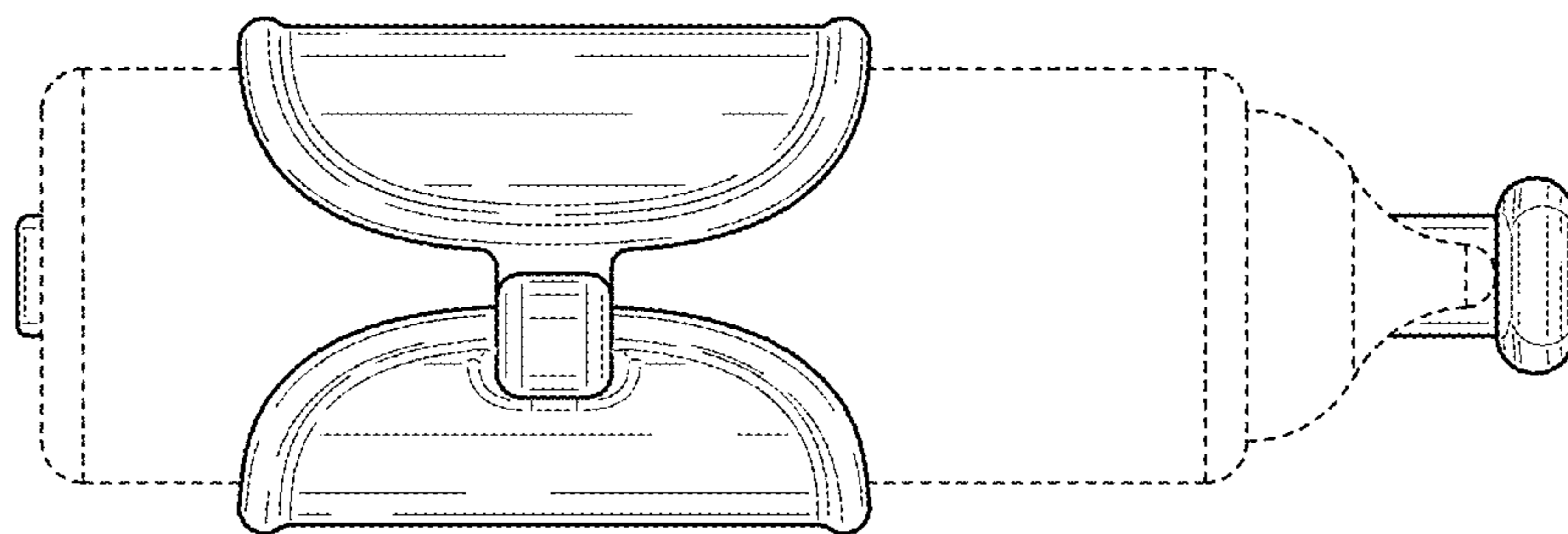

FIG. 7