



US00D976261S

(12) **United States Design Patent**
McGowan

(10) **Patent No.:** **US D976,261 S**

(45) **Date of Patent:** **** *Jan. 24, 2023**

(54) **DEVICE CASE**

(71) Applicant: **AMBULANT, INC.**, Bend, OR (US)

(72) Inventor: **Joseph Cole McGowan**, Bend, OR (US)

(73) Assignee: **Ambulant, Inc.**, Bend, OR (US)

(*) Notice: This patent is subject to a terminal disclaimer.

(**) Term: **15 Years**

(21) Appl. No.: **29/737,985**

(22) Filed: **Jun. 12, 2020**

(51) **LOC (14) Cl.** **14-02**

(52) **U.S. Cl.**
USPC **D14/440**

(58) **Field of Classification Search**
USPC D14/440, 447, 250, 315, 251; 206/45.23,
206/320, 45.2; 361/679.55; 294/25;
224/218
CPC ... G06F 1/1628; G06F 1/1626; A47B 23/044;
H04B 1/3888
See application file for complete search history.

(56) **References Cited**

U.S. PATENT DOCUMENTS

- D619,987 S * 7/2010 Scherf D14/138 AC
- D747,321 S * 1/2016 London D14/440
- D765,085 S * 8/2016 Moore D14/440
- D777,154 S * 1/2017 McGowan D14/250
- D839,257 S * 1/2019 Polseno, Sr. D14/250
- 10,274,814 B2 * 4/2019 Jeon F16M 11/041
- D847,804 S * 5/2019 Polseno D14/250
- D881,893 S * 4/2020 Zanxiang D14/440
- D902,194 S * 11/2020 Gluck D14/253

(Continued)

FOREIGN PATENT DOCUMENTS

- CN 305750572 S 5/2020
- CN 305791560 S 5/2020

OTHER PUBLICATIONS

Search Report receive in Taiwan application TW109307013 dated Jan. 26, 2022.

Primary Examiner — Cynthia R Underwood

(74) *Attorney, Agent, or Firm* — Buchalter; Jason W. Croft

(57) **CLAIM**

The ornamental design for a device case, as shown and described.

DESCRIPTION

FIG. 1 is an upper perspective view of a device case in a first configuration;
 FIG. 2 is a lower perspective view of the device case of FIG. 1;
 FIG. 3 is a front view thereof;
 FIG. 4 is a rear view thereof;
 FIG. 5 is a left view thereof;
 FIG. 6 is a right view thereof;
 FIG. 7 is a top view thereof;
 FIG. 8 is a bottom view thereof;
 FIG. 9 is an upper perspective view of the device case of FIGS. 1-8 in a second configuration;
 FIG. 10 is a front view of the device case of FIGS. 1-8 in the second configuration;
 FIG. 11 is a rear view of the device case of FIGS. 1-8 in the second configuration;
 FIG. 12 is a left view of the device case of FIGS. 1-8 in the second configuration;
 FIG. 13 is a right view of the device case of FIGS. 1-8 in the second configuration;
 FIG. 14 is a top view of the device case of FIGS. 1-8 in the second configuration; and,
 FIG. 15 is a bottom view of the device case of FIGS. 1-8 in the second configuration.

The broken lines represent portions of the structure that form no part of the claim.

1 Claim, 15 Drawing Sheets

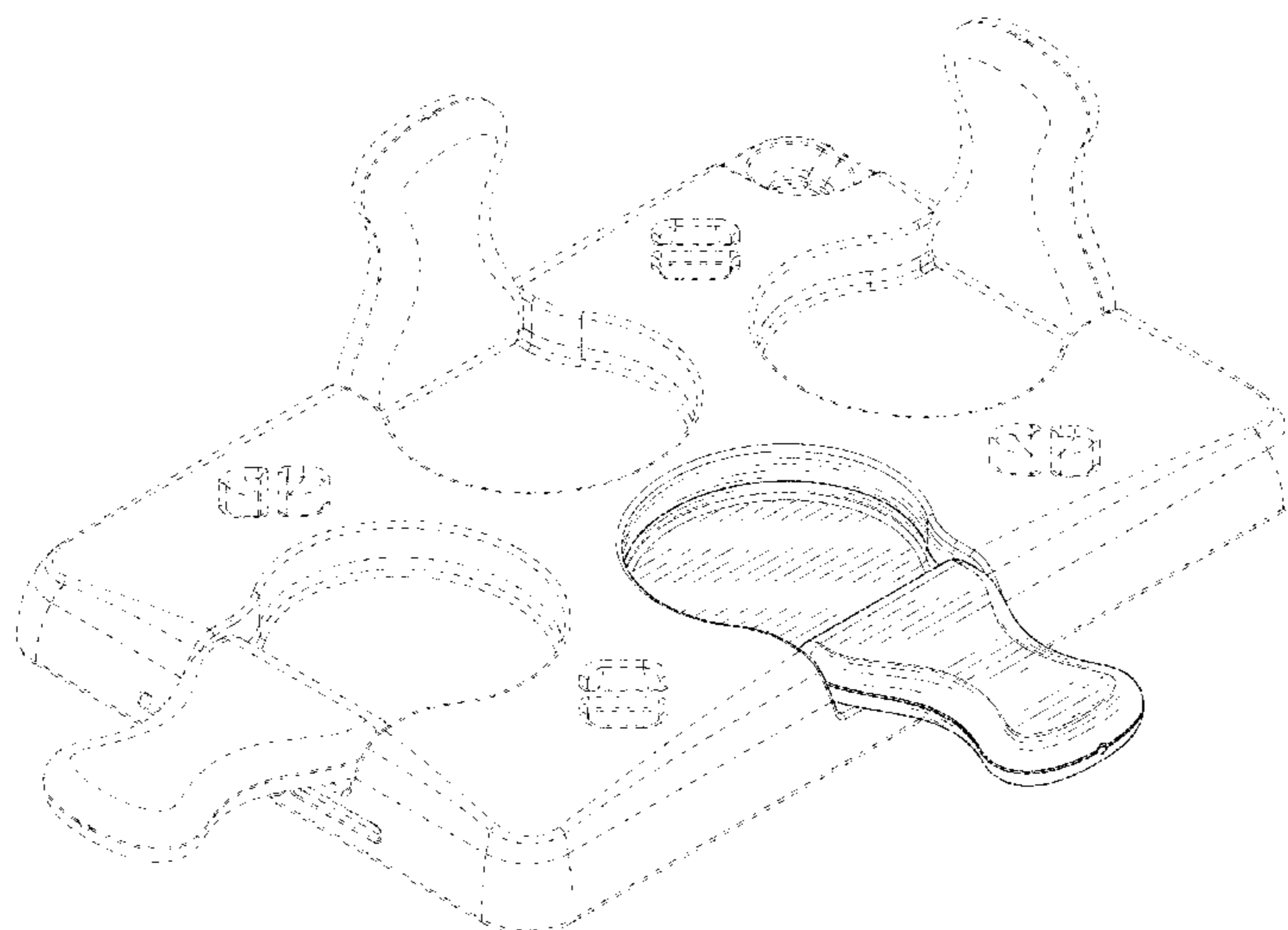

(56)

References Cited

U.S. PATENT DOCUMENTS

D912,677 S * 3/2021 Li D14/440
D913,294 S * 3/2021 Li D14/440
D918,889 S * 5/2021 Huang D14/251
2011/0084081 A1* 4/2011 Chung A45F 5/00
220/628
2012/0145843 A1* 6/2012 Ho F16M 13/00
248/176.3
2014/0124388 A1* 5/2014 McGowan G06F 1/1626
206/37
2015/0175309 A1* 6/2015 McGowan A45F 5/00
224/191
2015/0374118 A1* 12/2015 van Hooft A45C 11/00
248/451
2019/0208046 A1* 7/2019 Gluck F16M 11/2021

* cited by examiner

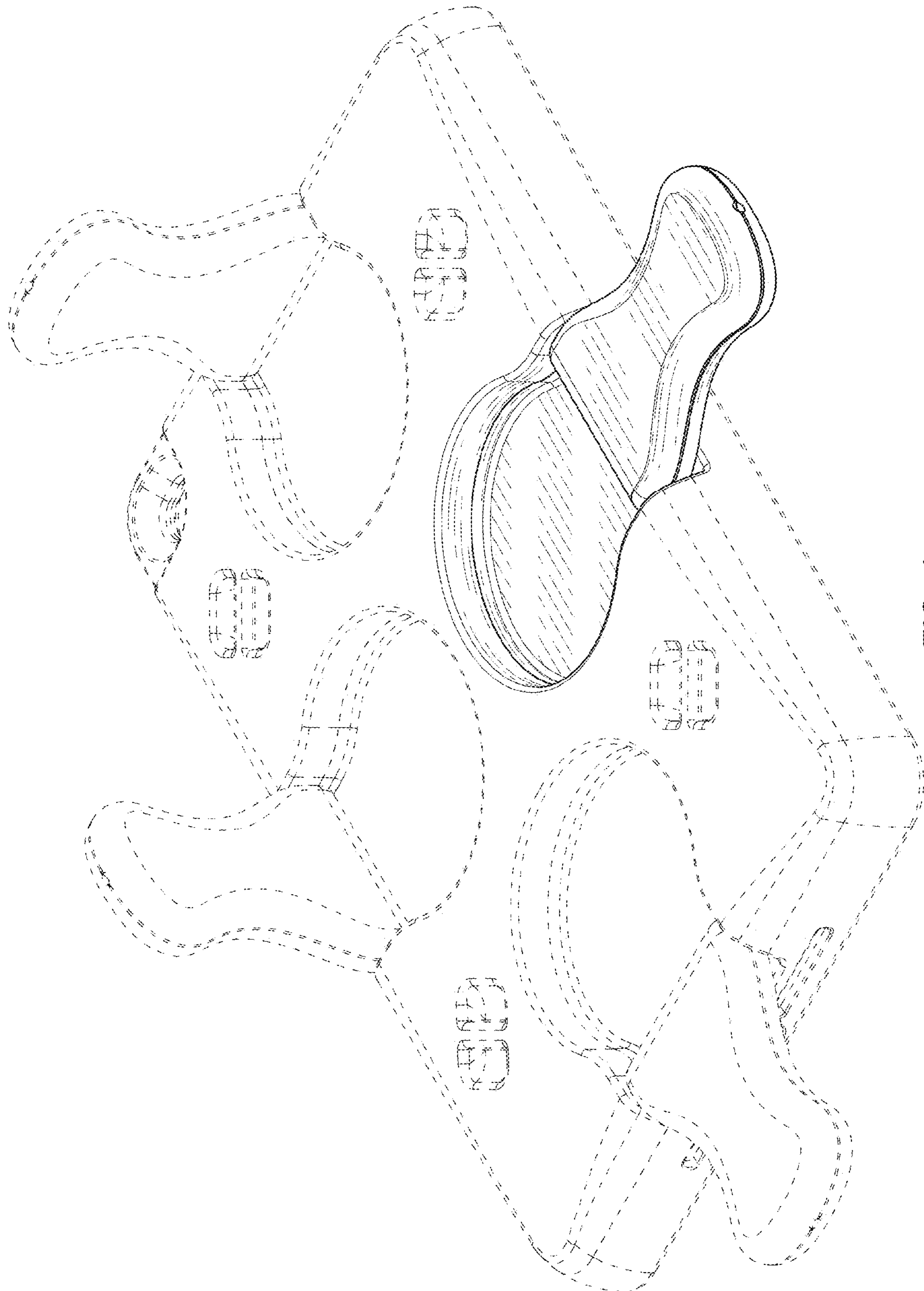

FIG. 1

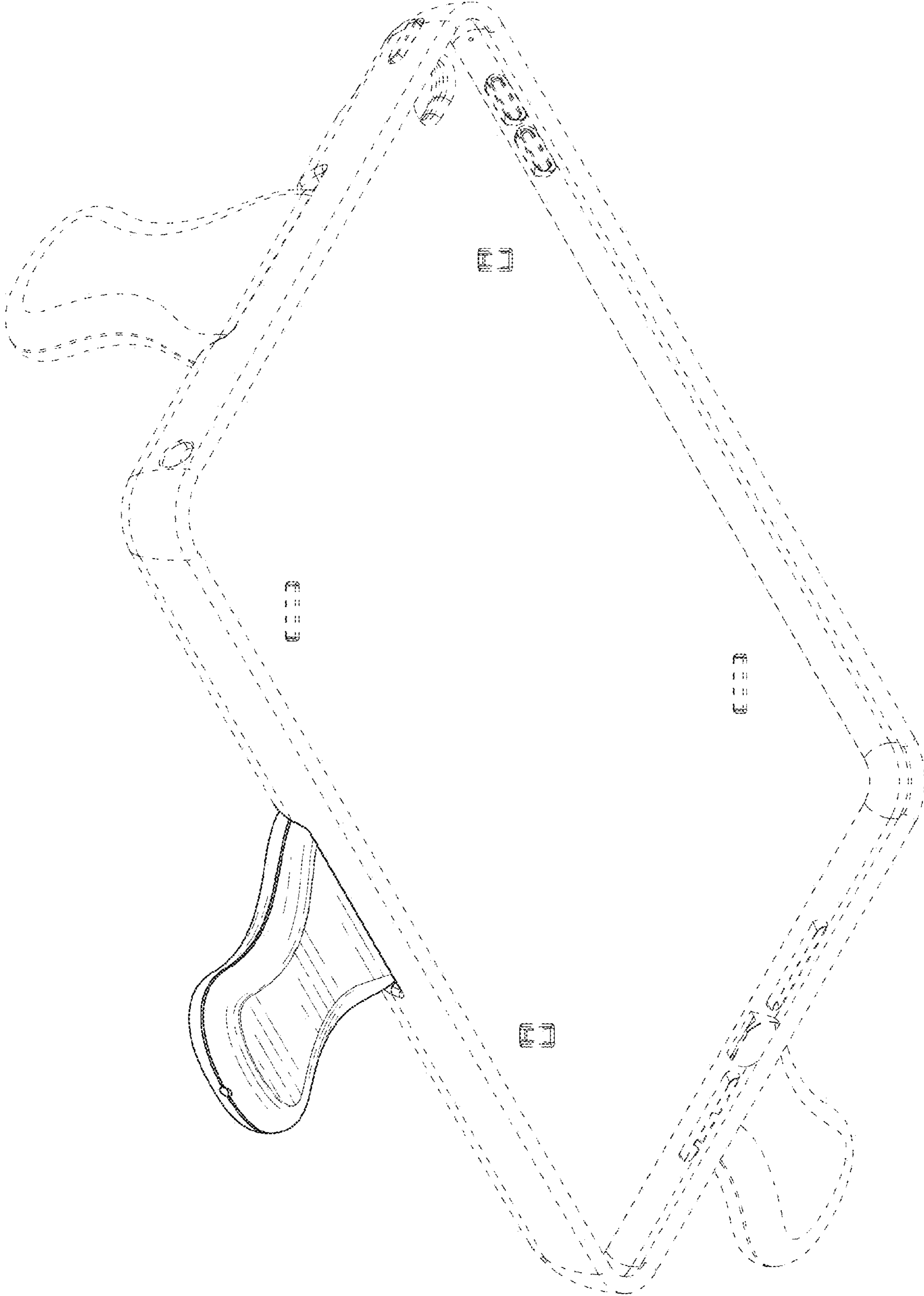

FIG. 2

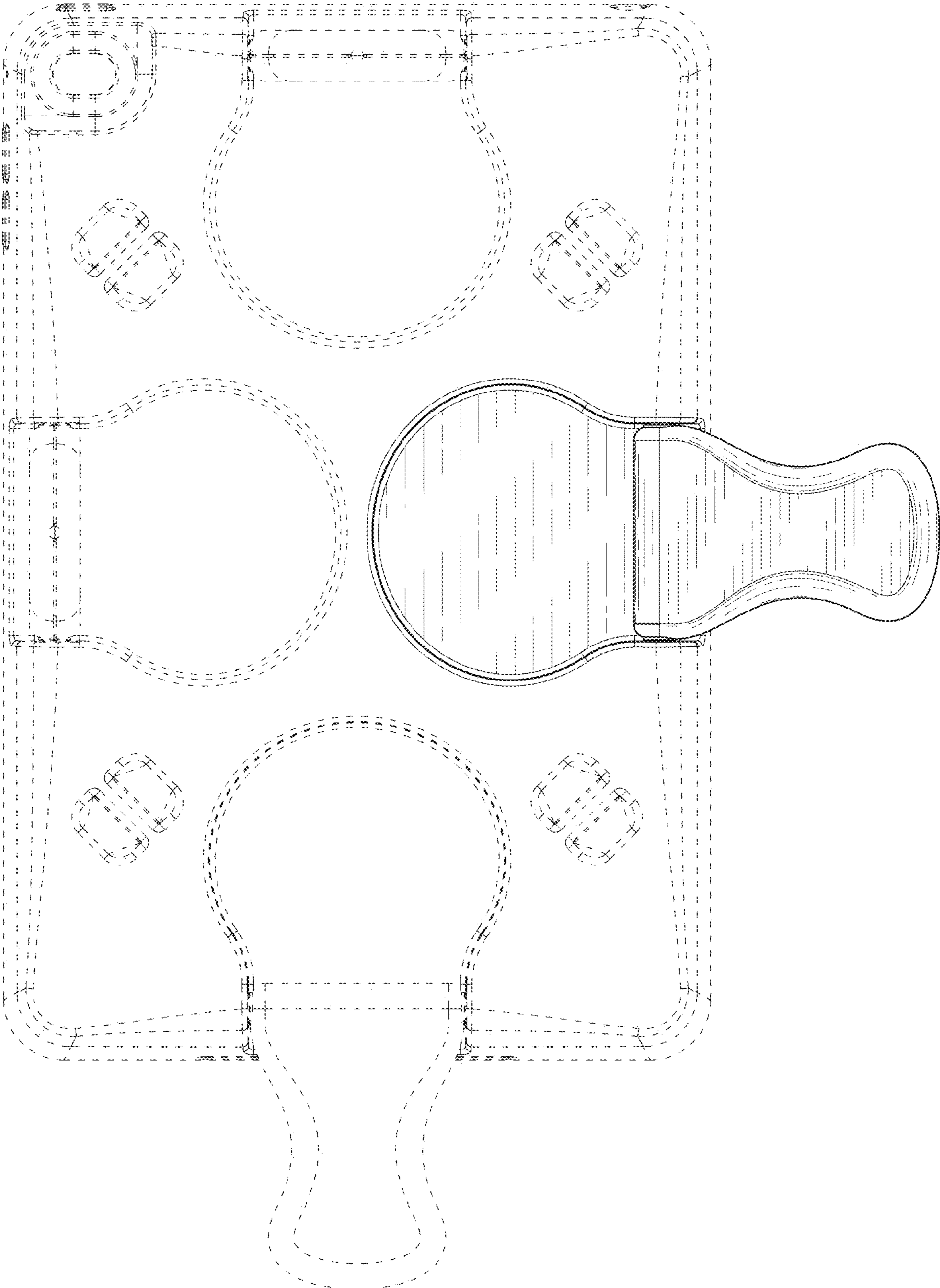

FIG. 3

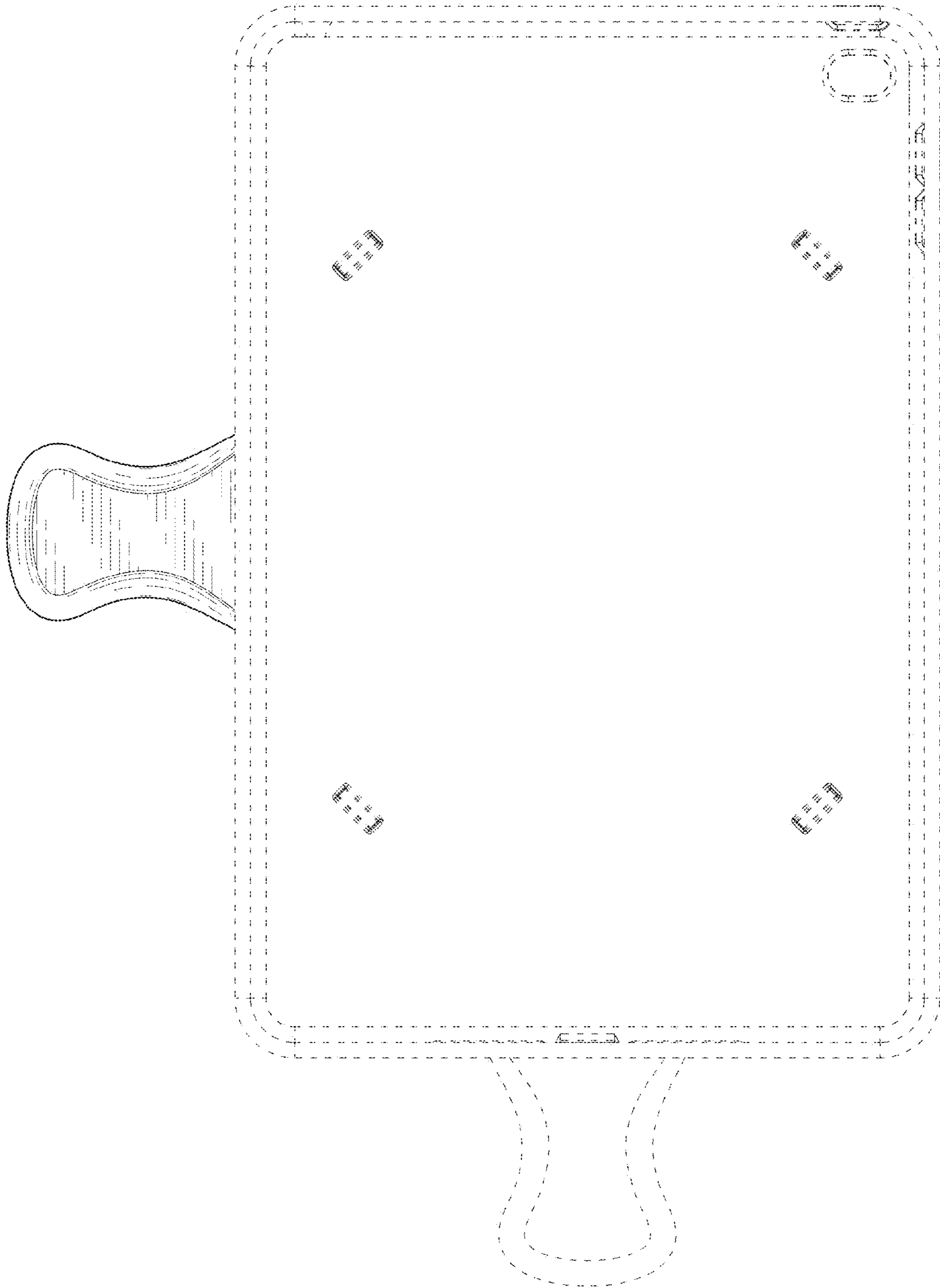

FIG. 4

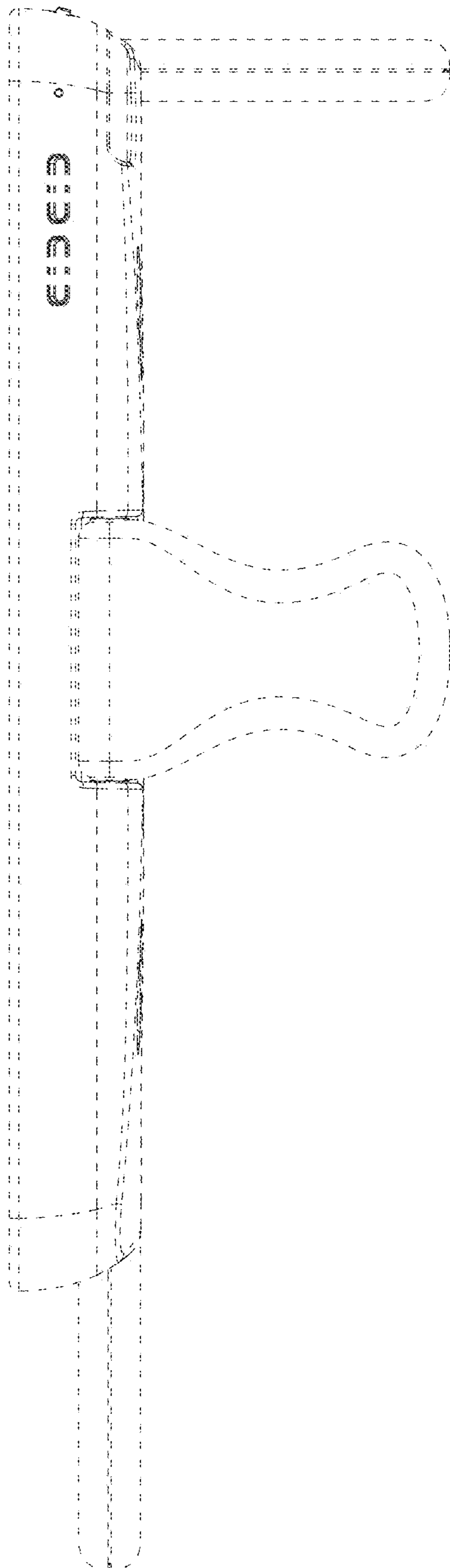

FIG. 5

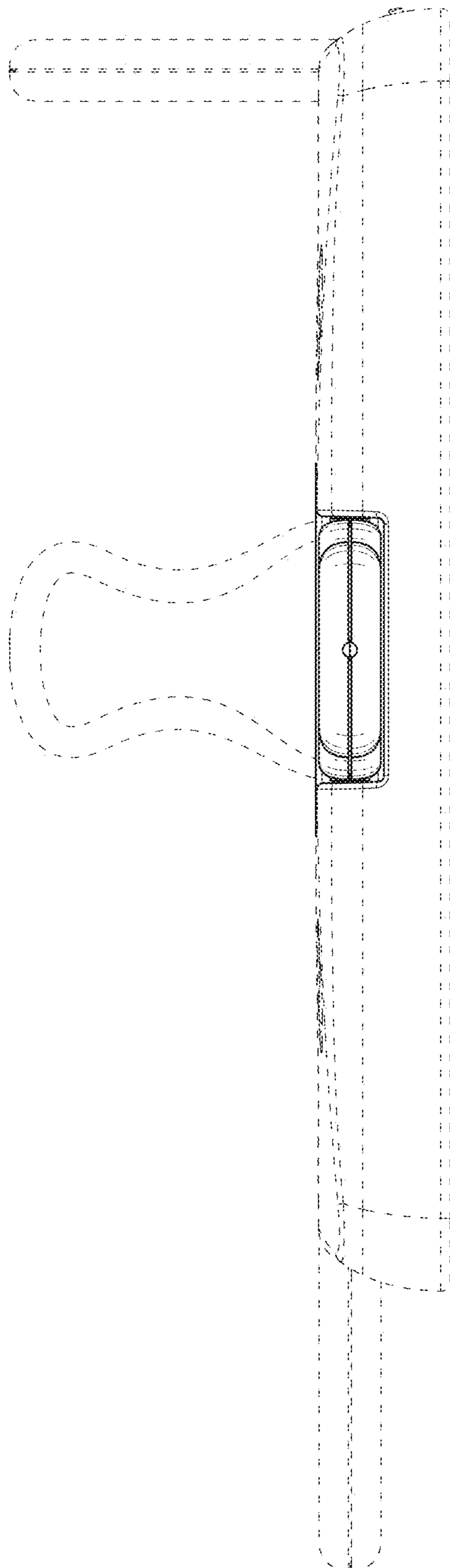

FIG. 6

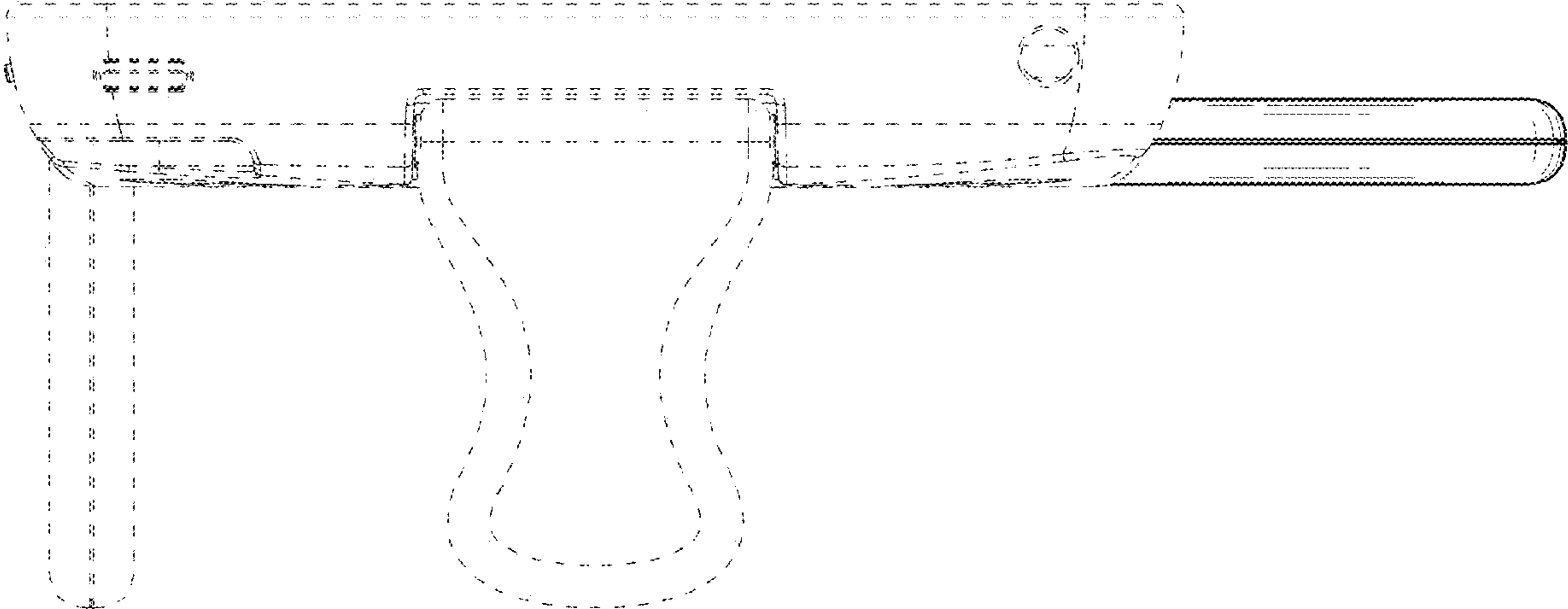

FIG. 7

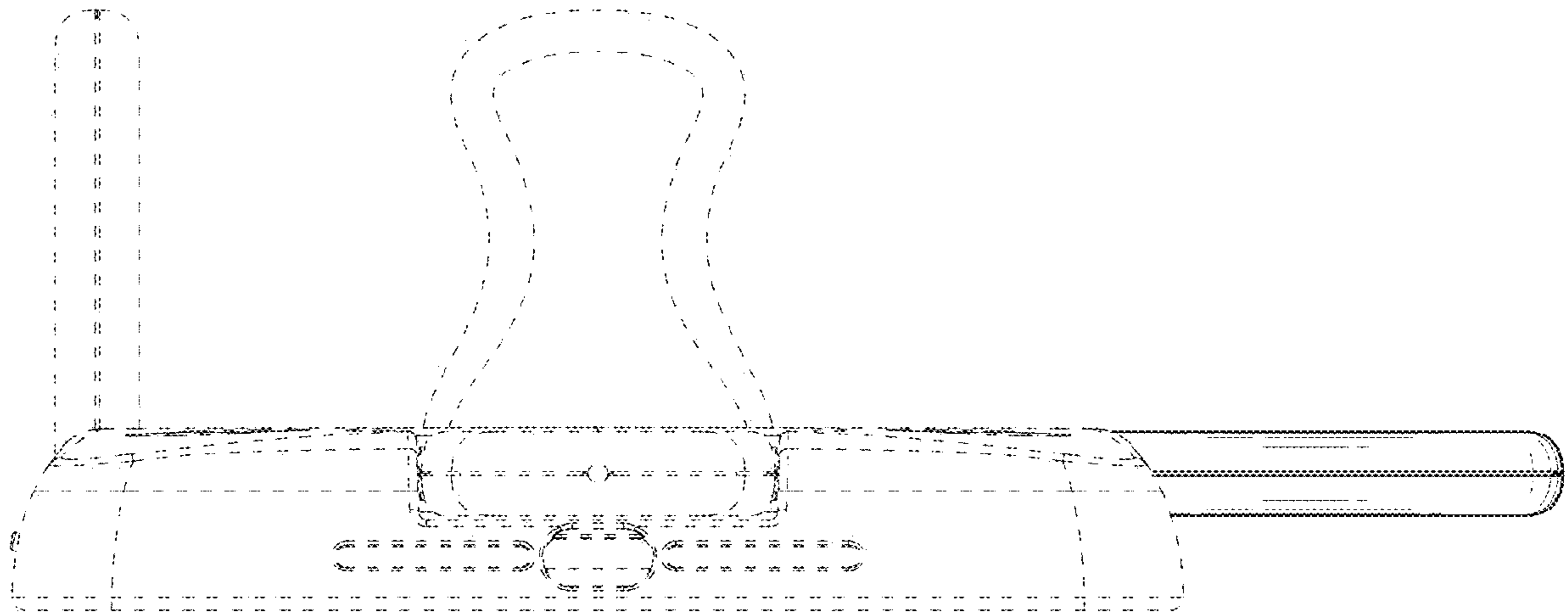

FIG. 8

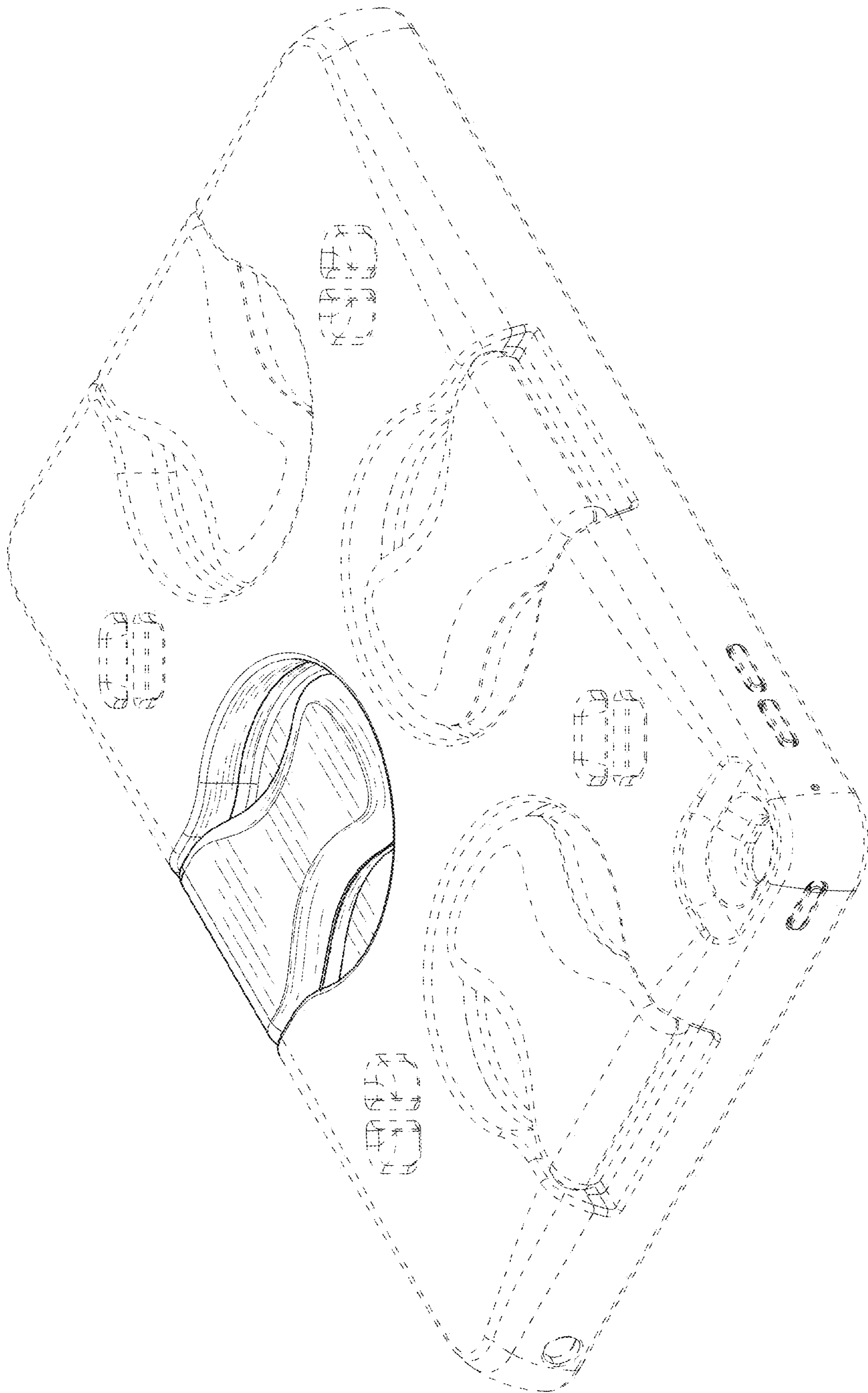

FIG. 9

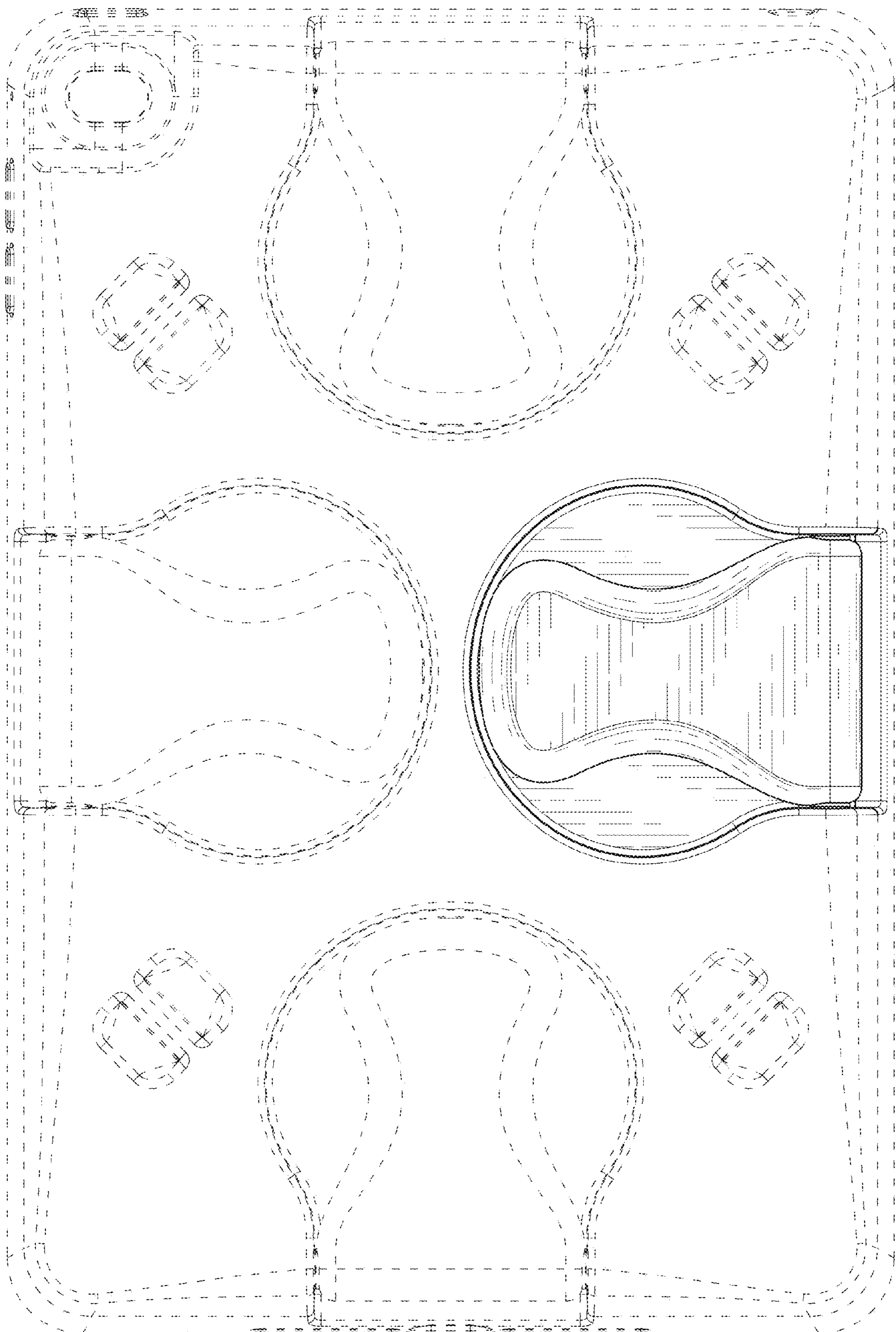

FIG. 10

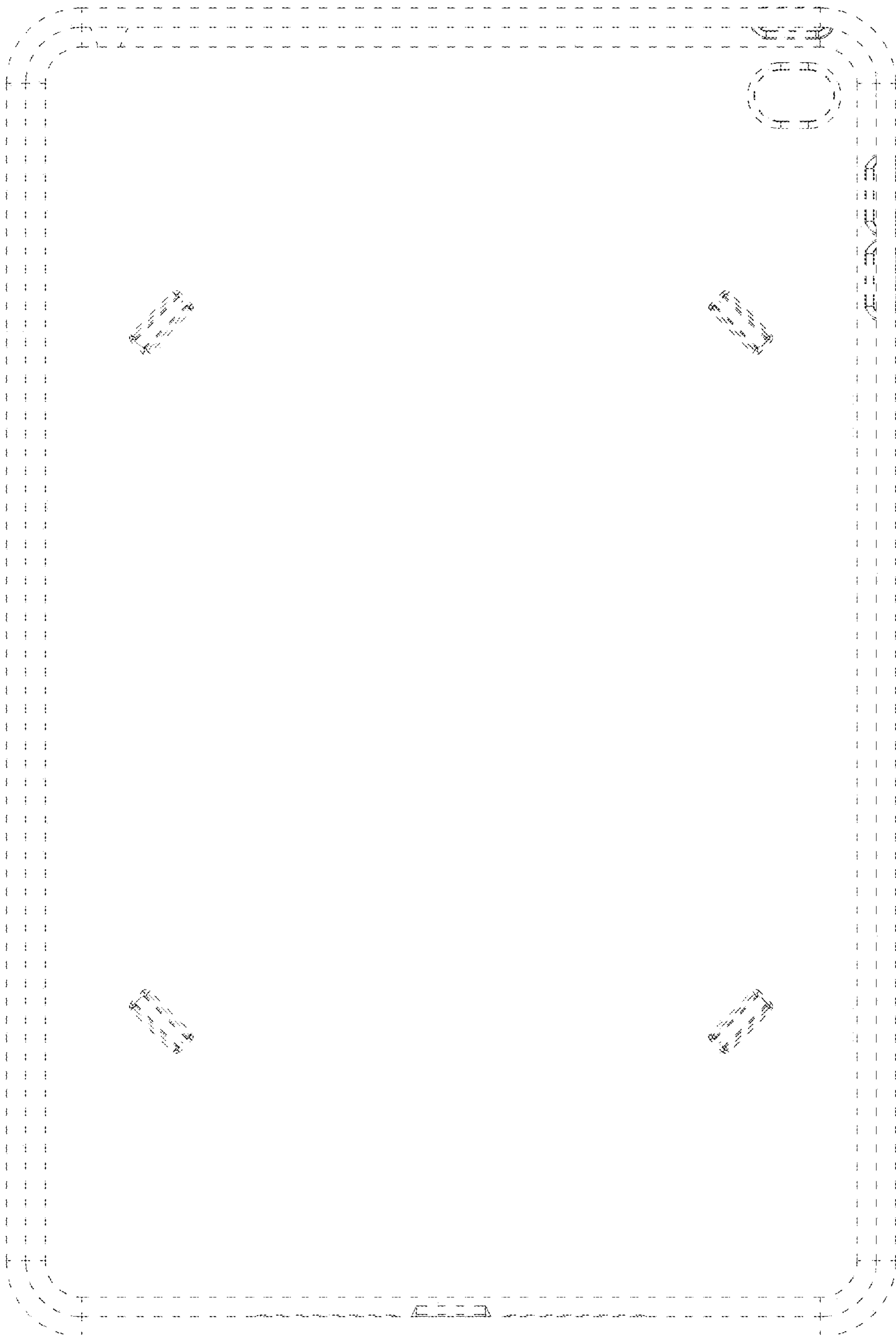

FIG. 11

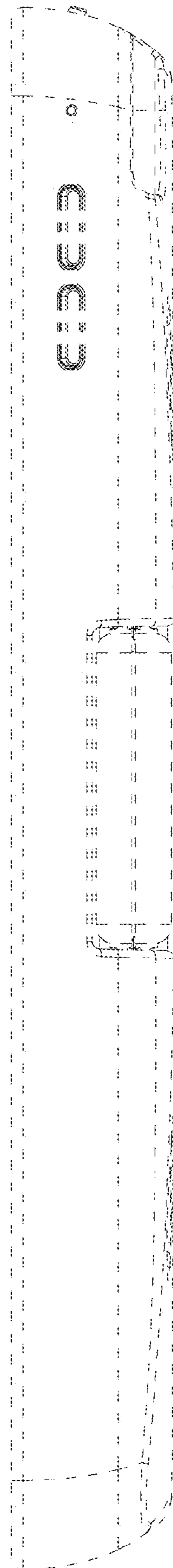

FIG. 12

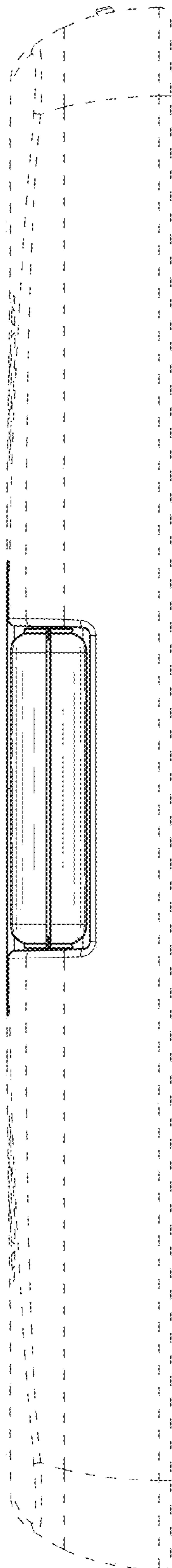

FIG. 13

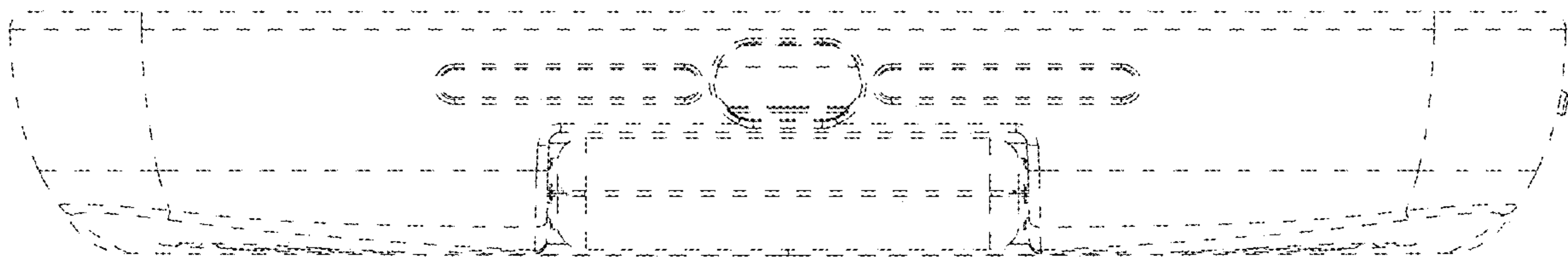

FIG. 14

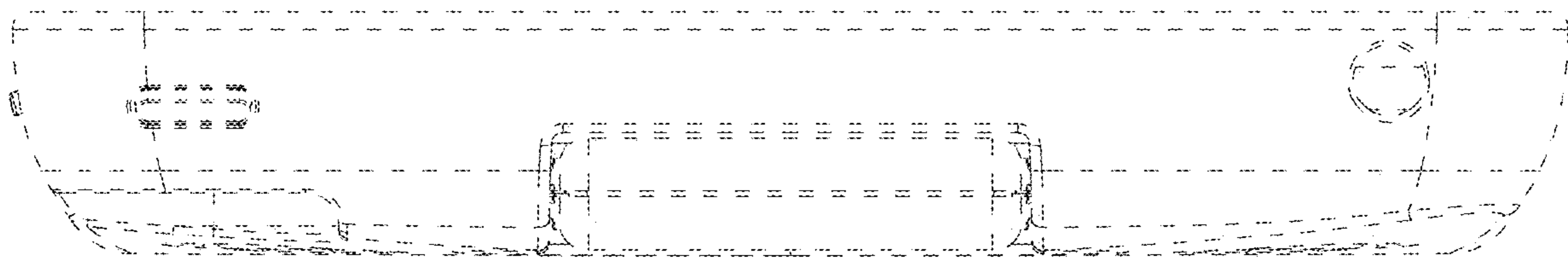

FIG. 15