



US00D976257S

(12) **United States Design Patent**
Zhang et al.

(10) **Patent No.:** **US D976,257 S**

(45) **Date of Patent:** **** *Jan. 24, 2023**

(54) **HARD DISK CASE**

(71) Applicant: **Ugreen Group Limited**, Shenzhen (CN)

(72) Inventors: **Qingsen Zhang**, Shenzhen (CN);
Junling Chen, Shenzhen (CN); **Sinan Lin**, Shenzhen (CN)

(*) Notice: This patent is subject to a terminal disclaimer.

(**) Term: **15 Years**

(21) Appl. No.: **29/744,011**

(22) Filed: **Jul. 27, 2020**

(51) **LOC (14) Cl.** **14-02**

(52) **U.S. Cl.**

USPC **D14/348**; D14/355; D14/363

(58) **Field of Classification Search**

USPC D14/341, 345, 348, 353, 354, 355, 356, D14/357, 358, 361, 362, 370, 383, 384, D14/385, 432, 433, 434, 435, 435.1, 436, D14/437, 438, 439, 440, 474, 480, 480.1, D14/480.3, 480.5, 480.6, 480.7, 496, 507, D14/510, 511, 125, 135, 155, 242, 203.1, D14/203.3, 214, 300, 302, 308, 314, 367, D14/230; D13/184

CPC G06F 1/1632; G06F 1/1684; G06F 3/0673; G06F 3/0674; G06F 11/3044; G06F 13/122; G06F 13/382; G06F 13/385; G06K 19/041; G06K 19/07732; H05K 5/0004; H05K 5/0278; H05K 5/03; H05K 5/00; H05K 5/0043; H05K 5/0047; H05K 5/0052; H05K 5/0217; H05K 5/0243; H05K 5/0286; H05K 5/02; H04N 5/64; H04W 88/00

See application file for complete search history.

(56) **References Cited**

U.S. PATENT DOCUMENTS

D346,607 S * 5/1994 Bhargava D14/242
D484,128 S * 12/2003 Chung D14/433

D487,086 S * 2/2004 Chung D14/433
D502,173 S * 2/2005 Jung D14/240
D520,997 S * 5/2006 Lee D14/356
D529,512 S * 10/2006 Reawsanguanwong .. D14/203.3
D538,803 S * 3/2007 Chen D14/348
D565,568 S * 4/2008 Trifilio D14/356
D565,571 S * 4/2008 Trifilio D14/356
D766,866 S * 9/2016 Cho D14/167

(Continued)

OTHER PUBLICATIONS

Tccmebius External Hard Drive Enclosure. Tccmebius, amazon.com (online) 24 pages. Posted Aug. 5, 2017. [Retrieved Mar. 7, 2022] https://www.amazon.com/dp/B074LFFKHRL/ref=cm_sw_em_r_mt_dp_6K78XMKYNJFSVQVGVVTWQ?_encoding=UTF8&psc=1 (Year: 2017).*

(Continued)

Primary Examiner — Kathleen L Jones

Assistant Examiner — Cole Sanders Holman

(74) *Attorney, Agent, or Firm* — Rumit R. Kanakia

(57) **CLAIM**

The ornamental design for a hard disk case, as shown and described.

DESCRIPTION

FIG. 1 is a first perspective view of a hard disk case showing my new design;

FIG. 2 is a second perspective view thereof;

FIG. 3 is a front view thereof;

FIG. 4 is a back view thereof;

FIG. 5 is a left side view thereof;

FIG. 6 is a right side view thereof;

FIG. 7 is a top view thereof; and,

FIG. 8 is a bottom view thereof.

The broken lines shown in the drawings depict portions of the hard disk case in which the design is embodied that form no part of the claimed design.

1 Claim, 8 Drawing Sheets

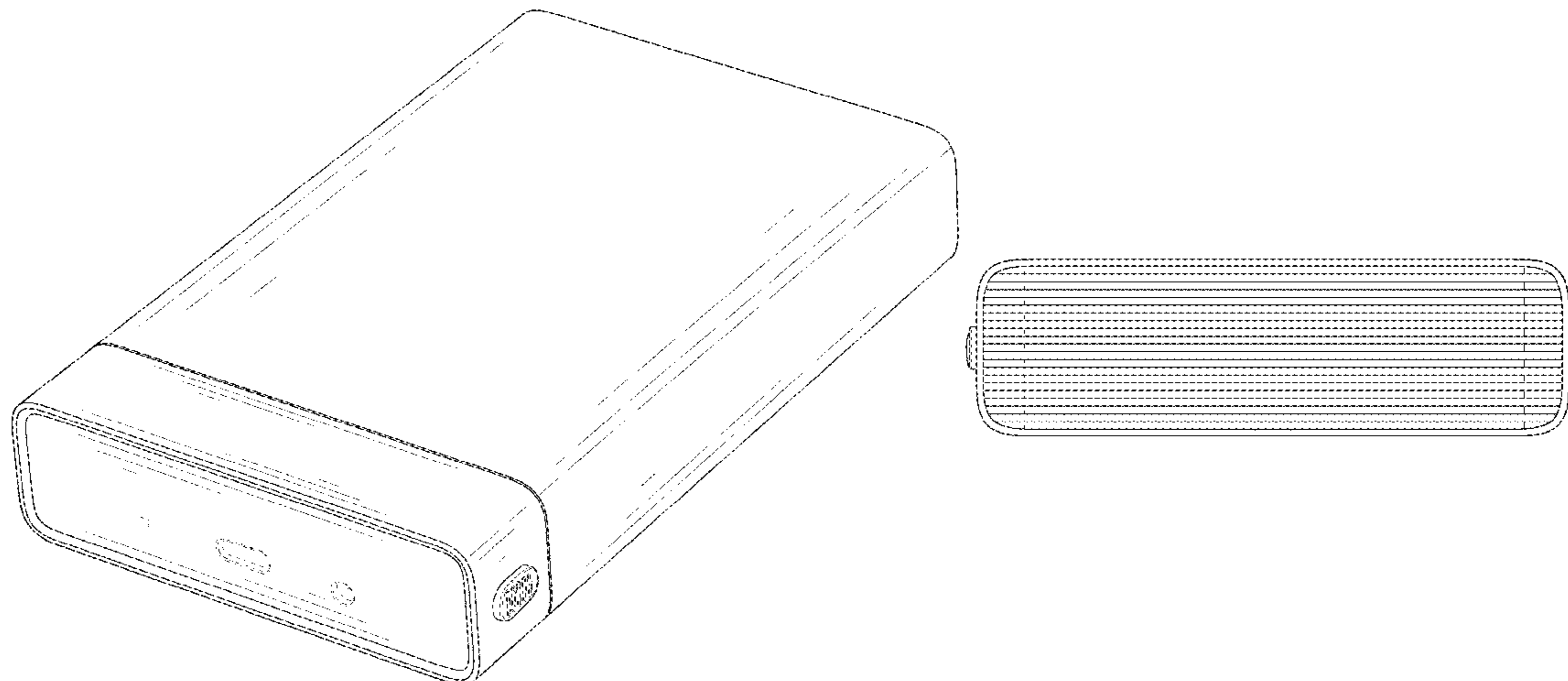

(56)

References Cited

U.S. PATENT DOCUMENTS

D790,539	S *	6/2017	Lee	D14/240
D848,419	S *	5/2019	Jun	D14/348
D853,999	S *	7/2019	Jiang	D14/242
D870,060	S *	12/2019	Zhang	D14/125
D873,881	S *	1/2020	Ma	D14/242
D894,863	S *	9/2020	Zheng	D10/104.1
D917,489	S *	4/2021	Jiang	D14/434
2005/0243503	A1 *	11/2005	Robertson	G11B 33/124
2006/0152899	A1 *	7/2006	Wang	G06F 1/1632 361/679.33
2009/0009953	A1 *	1/2009	Lin	G06F 1/1632 361/679.33

OTHER PUBLICATIONS

Zhang Guoxun, CN Design No. 304081356, published at Orbit, publication date Mar. 22, 2017. Site visited Mar. 7, 2022. Available from internet. (Year: 2017).*

Deng Qin Sheng, CN Design No. 305321605, published at Orbit, publication date Aug. 27, 2019. Site visited Mar. 7, 2022. Available from internet. (Year: 2019).*

Zhang et al., CN Design No. 306053249, published at Orbit, publication date Sep. 24, 2020. Site visited Mar. 7, 2022. Available from internet. (Year: 2020).*

* cited by examiner

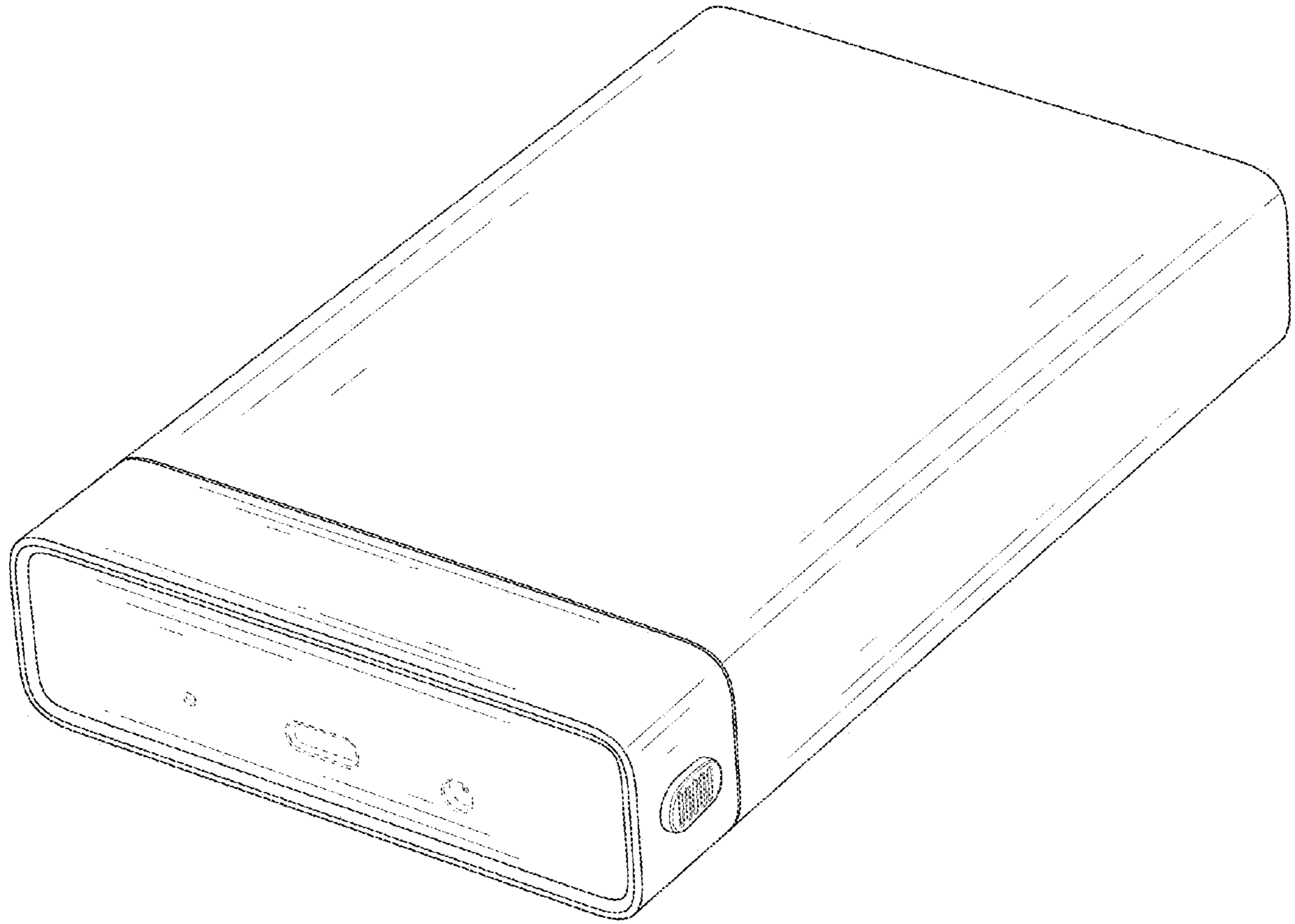

FIG. 1

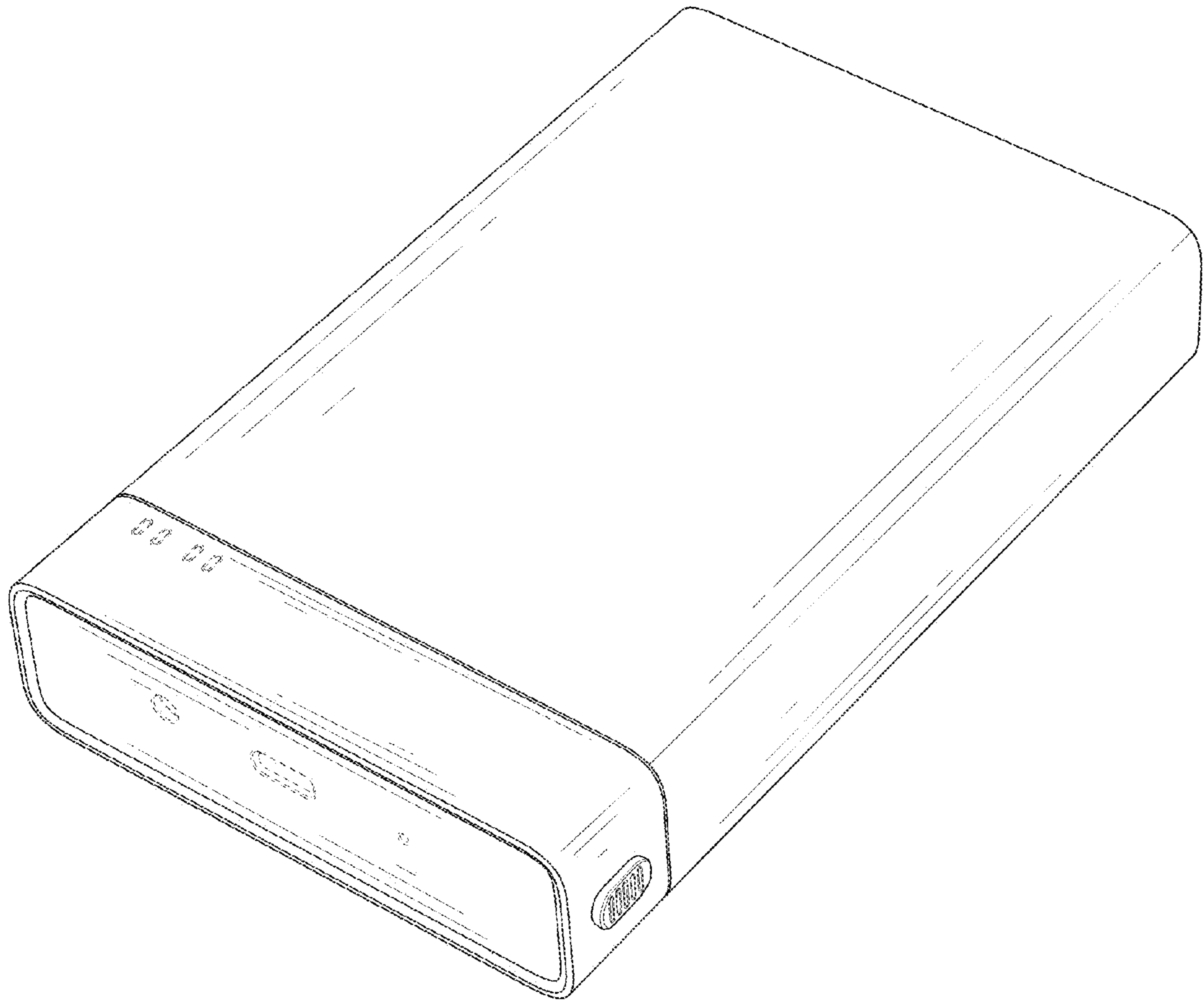

FIG. 2

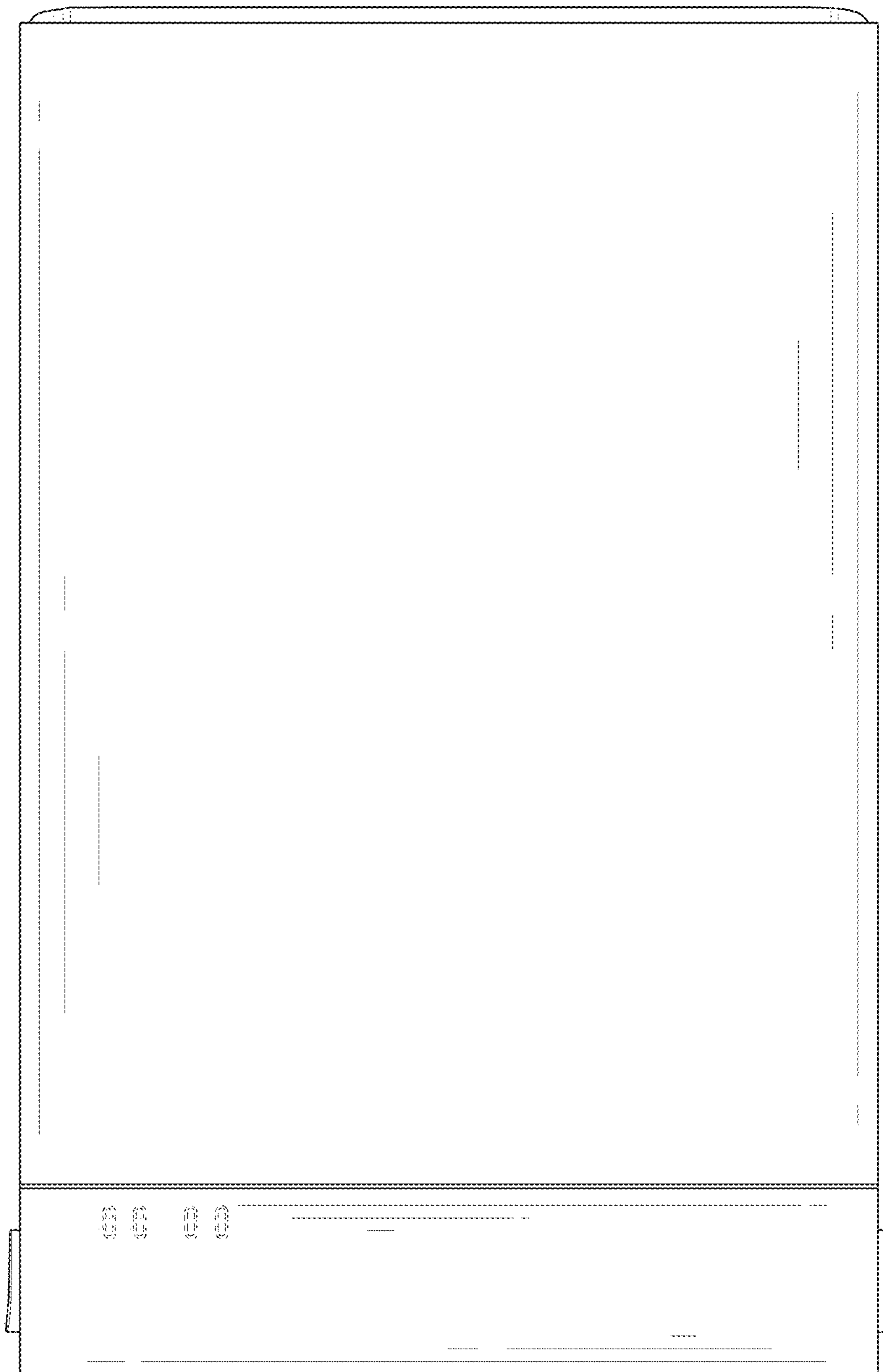

FIG. 3

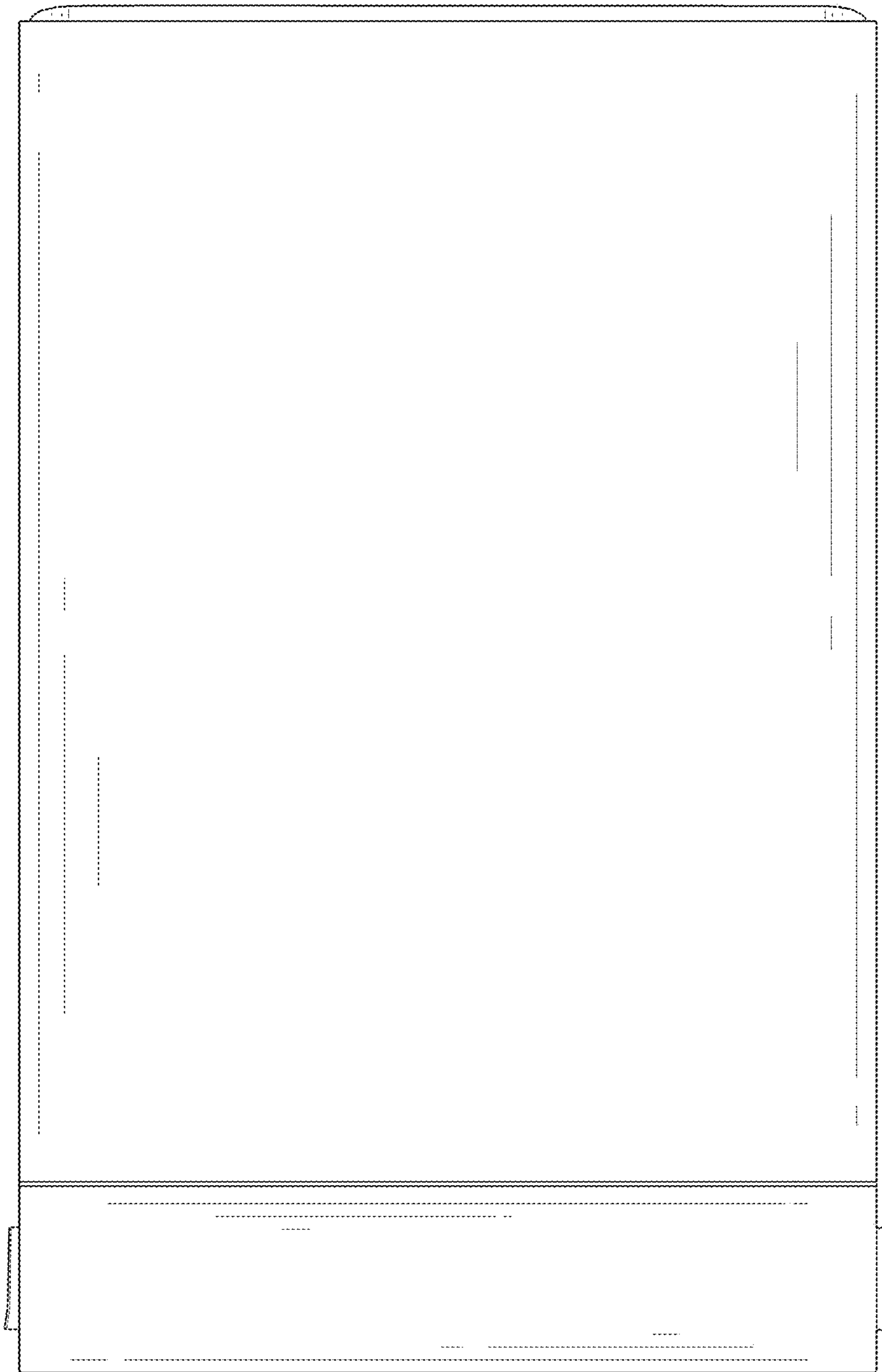

FIG. 4

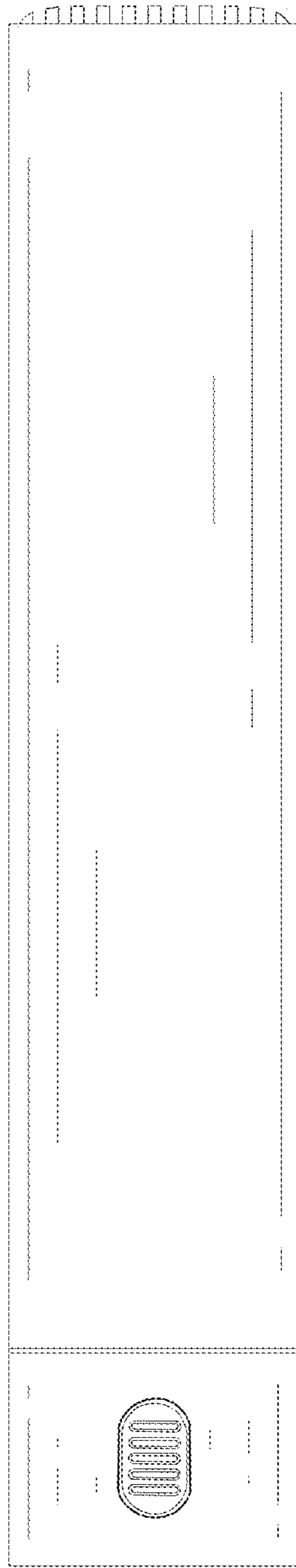

FIG. 5

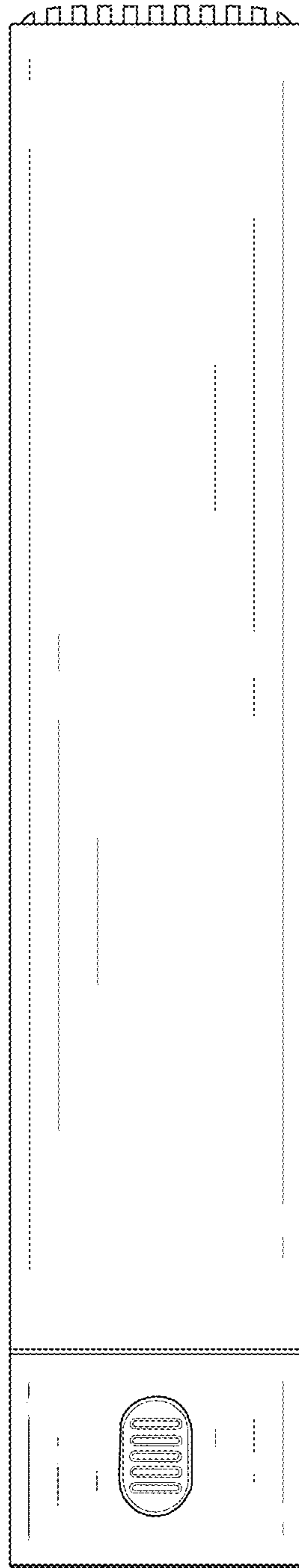

FIG. 6

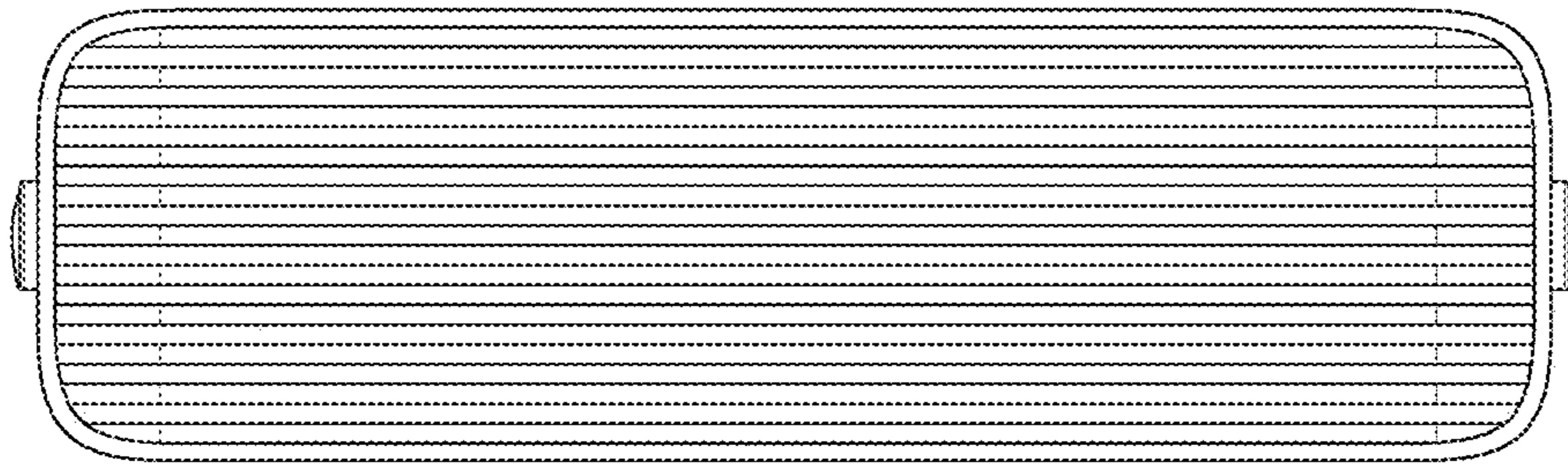

FIG. 7

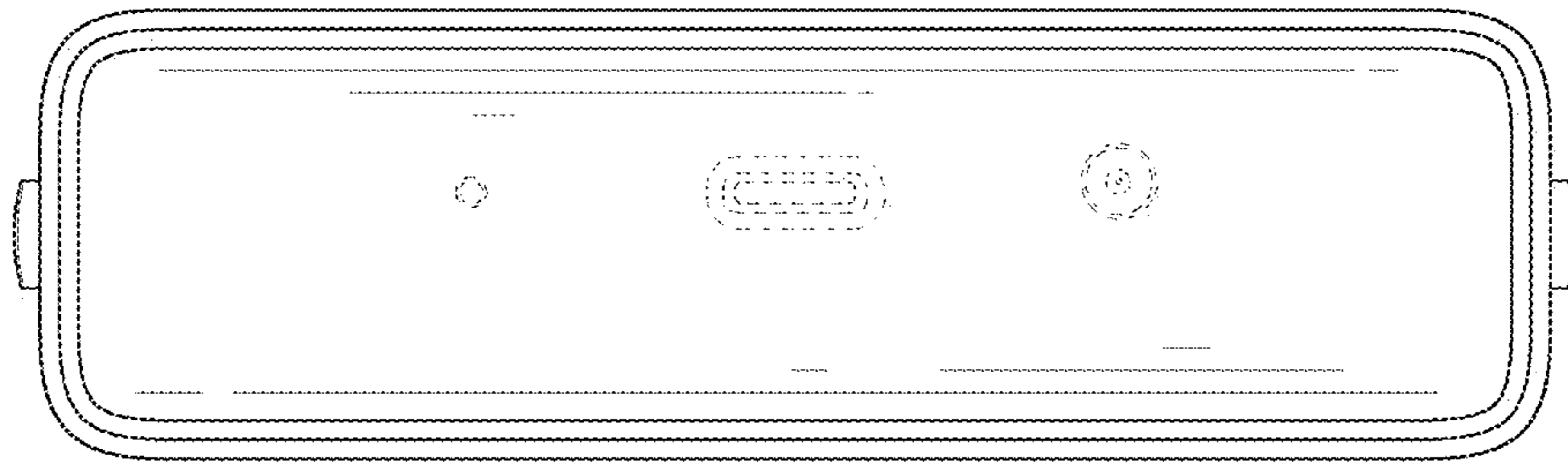

FIG. 8