



US00D976250S

(12) **United States Design Patent** (10) **Patent No.:** **US D976,250 S**  
**Lee et al.** (45) **Date of Patent:** **\*\* Jan. 24, 2023**

(54) **CASE FOR ELECTRONIC DEVICE**

D751,539 S \* 3/2016 Ahn ..... D14/250  
D762,205 S \* 7/2016 Dang ..... D14/250  
D765,639 S \* 9/2016 Lay ..... D14/250

(71) Applicant: **Samsung Electronics Co., Ltd.**,  
Suwon-si (KR)

(Continued)

(72) Inventors: **Joo-Hyung Lee**, Suwon-si (KR);  
**Sang-Sik Park**, Suwon-si (KR)

**FOREIGN PATENT DOCUMENTS**

(73) Assignee: **Samsung Electronics Co., Ltd.**,  
Suwon-si (KR)

CN 307122480 \* 2/2022  
JP D1709241 \* 3/2022

(\*\*) Term: **15 Years**

**OTHER PUBLICATIONS**

(21) Appl. No.: **29/775,988**

Samsung S View Flip Cover for Galaxy S20 FE, date not known [online], retrieved Aug. 22, 2022, retrieved from the internet: < <https://www.bestbuy.com/site/samsung-s-view-flip-cover-for-galaxy-s20-fe-navy/6432270> > (Year: 2022).\*

(22) Filed: **Mar. 26, 2021**

(Continued)

(30) **Foreign Application Priority Data**

Jan. 14, 2021 (KR) ..... 30-2021-0002045

*Primary Examiner* — Messina L Smith

(51) **LOC (14) Cl.** ..... **14-03**

*Assistant Examiner* — Rodolfo Castro, Jr.

(52) **U.S. Cl.**

(74) *Attorney, Agent, or Firm* — NSIP Law

USPC ..... **D14/250**; D14/251

(58) **Field of Classification Search**

(57) **CLAIM**

USPC ..... D3/201, 215, 218, 233, 247, 249, 267,  
D3/269, 273, 300, 303, 307, 323;  
D10/104.1, 50, 65, 74; D14/238, 238.1,  
D14/341, 342, 343, 344, 345, 346, 347,  
D14/426, 240, 447, 451, 440, 432-434,  
D14/452, 130, 496, 137, 138 R, 138 AA,  
D14/138 C, 138 G, 140, 140.8, 140.9,  
D14/140.11, 148, 147, 151, 203.1,  
D14/203.3-203.7, 209.1, 217, 218, 247,  
D14/248, 250, 251-253, 388, 389, 439,  
D14/482; D12/415, 410, 193; D13/103,  
D13/107-108, 156, 123, 133, 154, 158,  
D13/160, 173, 178, 184, 199;

We claim the ornamental design for a case for electronic device, as shown and described.

(Continued)

**DESCRIPTION**

(56) **References Cited**

FIG. 1 is a front perspective view of a case for electronic device showing our new design;  
FIG. 2 is a front view thereof;  
FIG. 3 is a rear view thereof;  
FIG. 4 is a left-side view thereof;  
FIG. 5 is a right-side view thereof;  
FIG. 6 is a top view thereof;  
FIG. 7 is a bottom view thereof; and,  
FIG. 8 is a rear perspective view thereof.  
The evenly dashed broken lines in the figures depict portions of the case for electronic device which form no part of the claimed design.

**U.S. PATENT DOCUMENTS**

D638,005 S \* 5/2011 Richardson ..... D14/250  
D751,057 S \* 3/2016 Ahn ..... D14/250

**1 Claim, 8 Drawing Sheets**

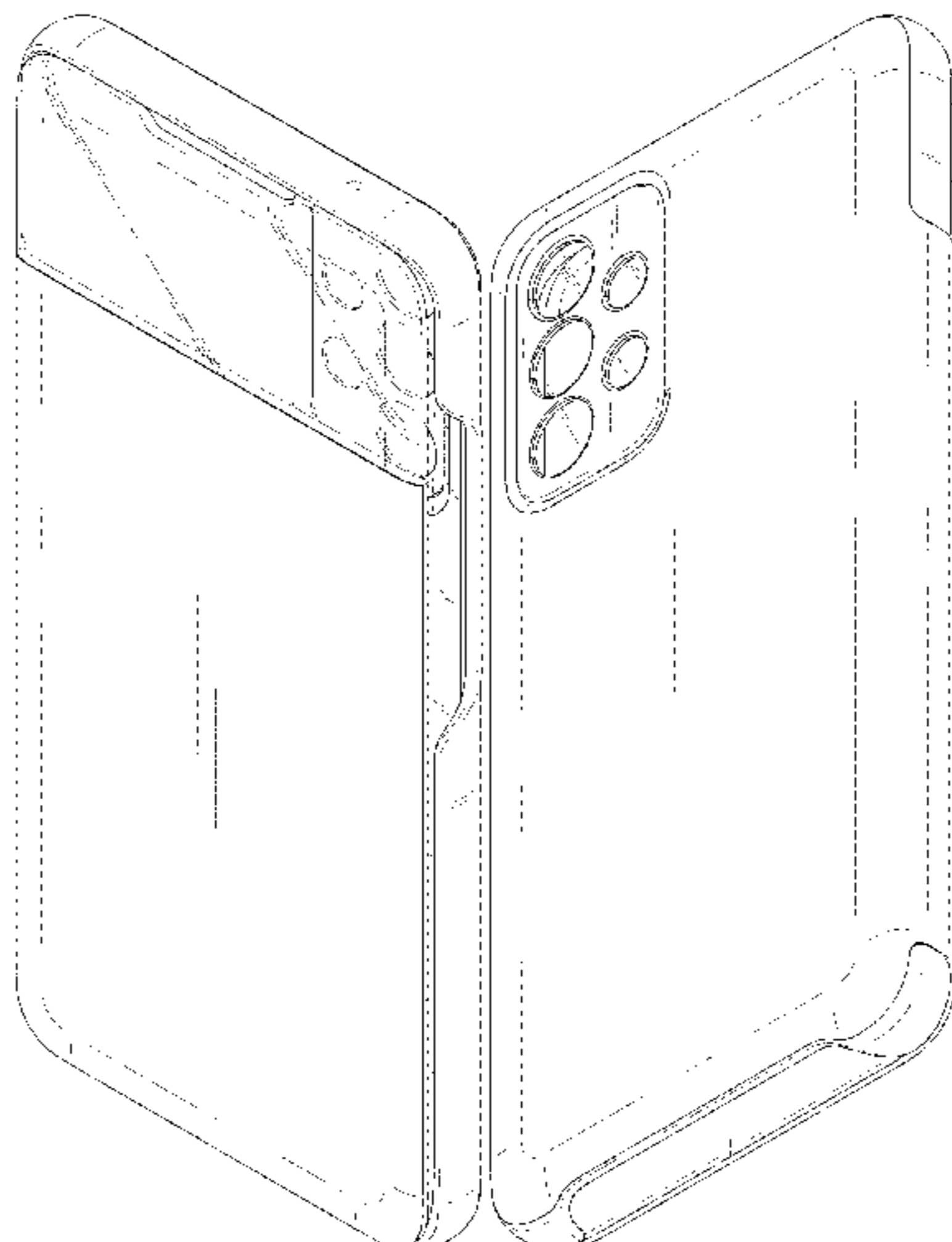

(58) **Field of Classification Search**

USPC ..... D18/4.4–4.6, 6, 7; D21/186, 330, 332,  
D21/324, 329  
CPC ..... G06F 3/041; G06F 3/0412; G06F 3/0416;  
G06F 3/0488; G06F 3/04883; G06F  
3/04886; G06F 1/1613; G06F 1/1624;  
G06F 1/1626; G06F 1/1633; G06F  
1/1641; G06F 1/1643; G06F 1/1692;  
G06F 2200/1633; G06F 2212/1721; G09F  
1/12; G09F 1/00; G09F 2007/1843; G09F  
2013/1881; H04B 1/3888; H04B 1/3833;  
H04B 1/04; H04B 1/03; H04B 1/08;  
A45C 13/02; A45C 13/002; A45C  
13/185; A45C 2011/002; A45C 1/06;  
A45F 2005/1006; A45F 2200/0516; A45F  
2200/0525; A47G 1/0605; A63H 33/3016;  
H04M 1/0283; H04M 1/0202; H04M  
1/0279; H04M 1/0281

See application file for complete search history.

(56) **References Cited**

U.S. PATENT DOCUMENTS

D776,102 S *	1/2017	Kim .....	D14/250
D776,645 S *	1/2017	Del Moral .....	D14/250
D794,008 S *	8/2017	Lee .....	D14/250
D810,067 S *	2/2018	Lee .....	D14/250
D896,210 S *	9/2020	Son .....	D14/250
D896,211 S *	9/2020	Cho .....	D14/250
D899,412 S *	10/2020	Lee .....	D14/250
D915,385 S *	4/2021	Lee .....	D14/250

D926,745 S *	8/2021	Ji .....	D14/250
D926,747 S *	8/2021	Ryu .....	D14/250
D928,767 S *	8/2021	Kim .....	D14/250
D928,770 S *	8/2021	Song .....	D14/250
D930,635 S *	9/2021	Akana .....	D14/250
D939,489 S *	12/2021	Choi .....	D14/250
D939,492 S *	12/2021	Kim .....	D14/250
D941,281 S *	1/2022	Ji .....	D14/250
D943,565 S *	2/2022	Kim .....	D14/250
2015/0169010 A1 *	6/2015	Shin .....	G06F 1/1626 206/45.23
2016/0295981 A1 *	10/2016	Lay .....	A45C 11/00
2022/0087386 A1 *	3/2022	Wright .....	H04B 1/3888

OTHER PUBLICATIONS

Galaxy A32 5G View Wallet Cover, White, date not known [online],  
retrieved Aug. 22, 2022, retrieved from the internet: < <https://www.samsung.com/us/mobile/mobile-accessories/phones/galaxy-a32-5g-s-view-wallet-cover-white-ef-ea326pwegus/> > (Year: 2022).\*

Official Samsung White S View Wallet Cover Case, date not known  
[online], retrieved Aug. 22, 2022, retrieved from the internet:  
<<https://www.mobilefun.com/official-samsung-white-s-view-wallet-cover-case-for-samsung-galaxy-a53-5g-88320>> (Year: 2022).\*

The best Samsung Galaxy A53 5G cases and covers, Apr. 27, 2022  
[online], retrieved Aug. 22, 2022, retrieved from the internet: <  
<https://www.digitaltrends.com/mobile/best-samsung-galaxy-a53-5g-cases/>> (Year: 2022).\*

Official Samsung Galaxy A51 S View Wallet Cover Review, Feb. 7,  
2020 [online], retrieved Sep. 7, 2022, retrieved from the internet: <  
<https://www.youtube.com/watch?v=4Saojz5Tqlw>> (Year: 2020).\*

\* cited by examiner

FIG. 1

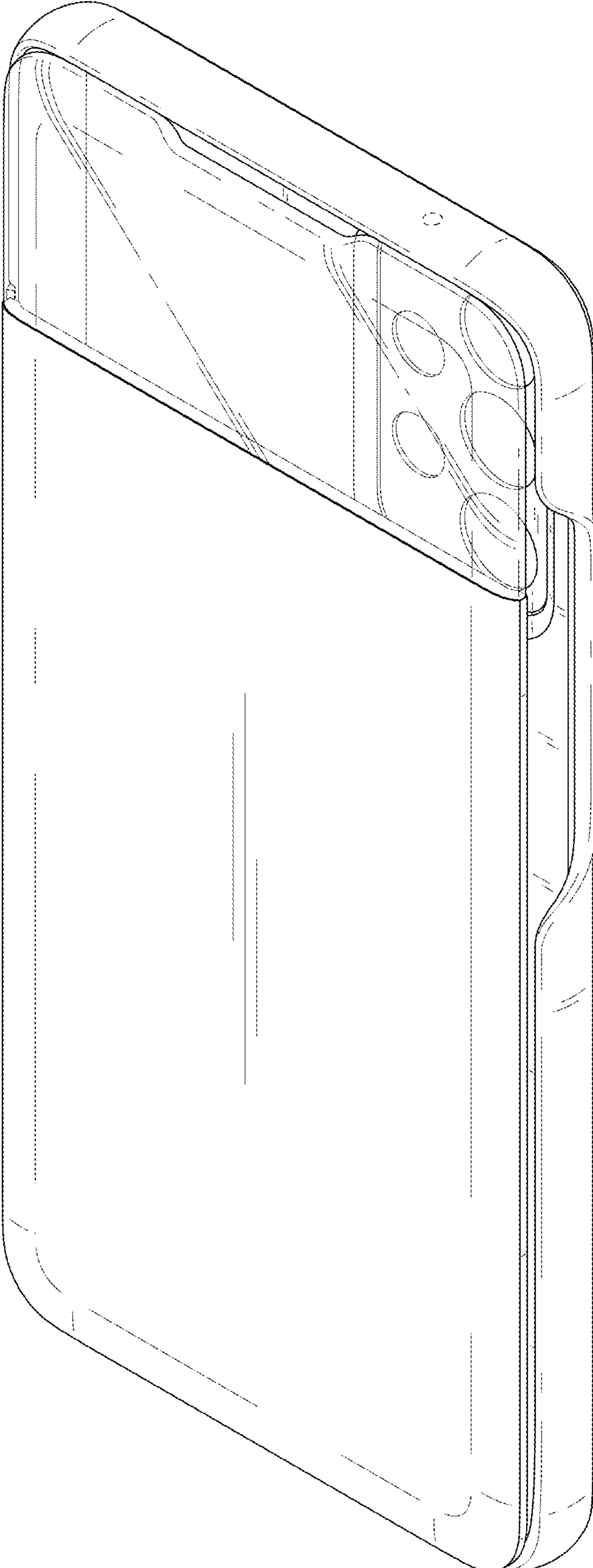

FIG. 2

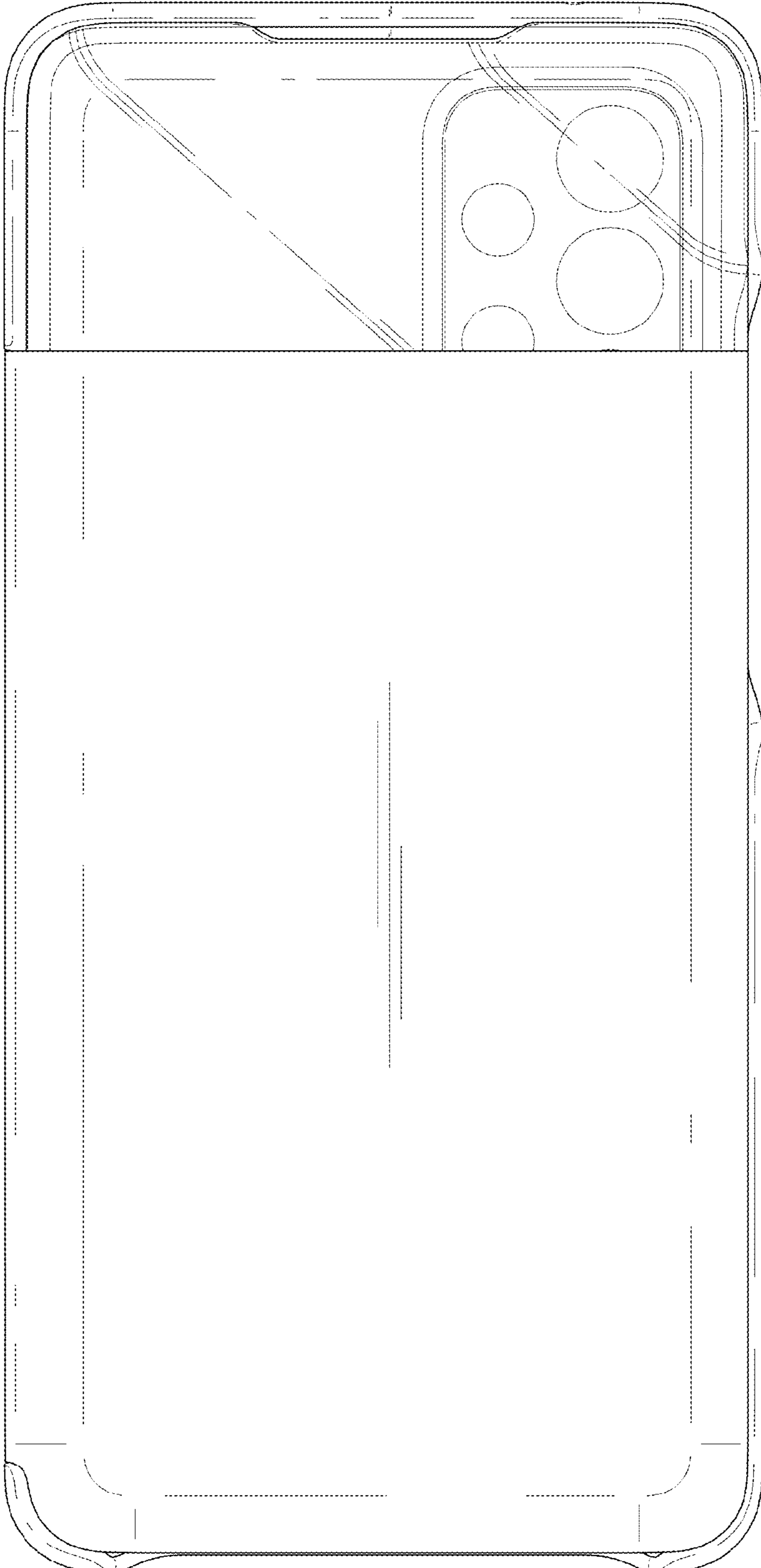

FIG. 3

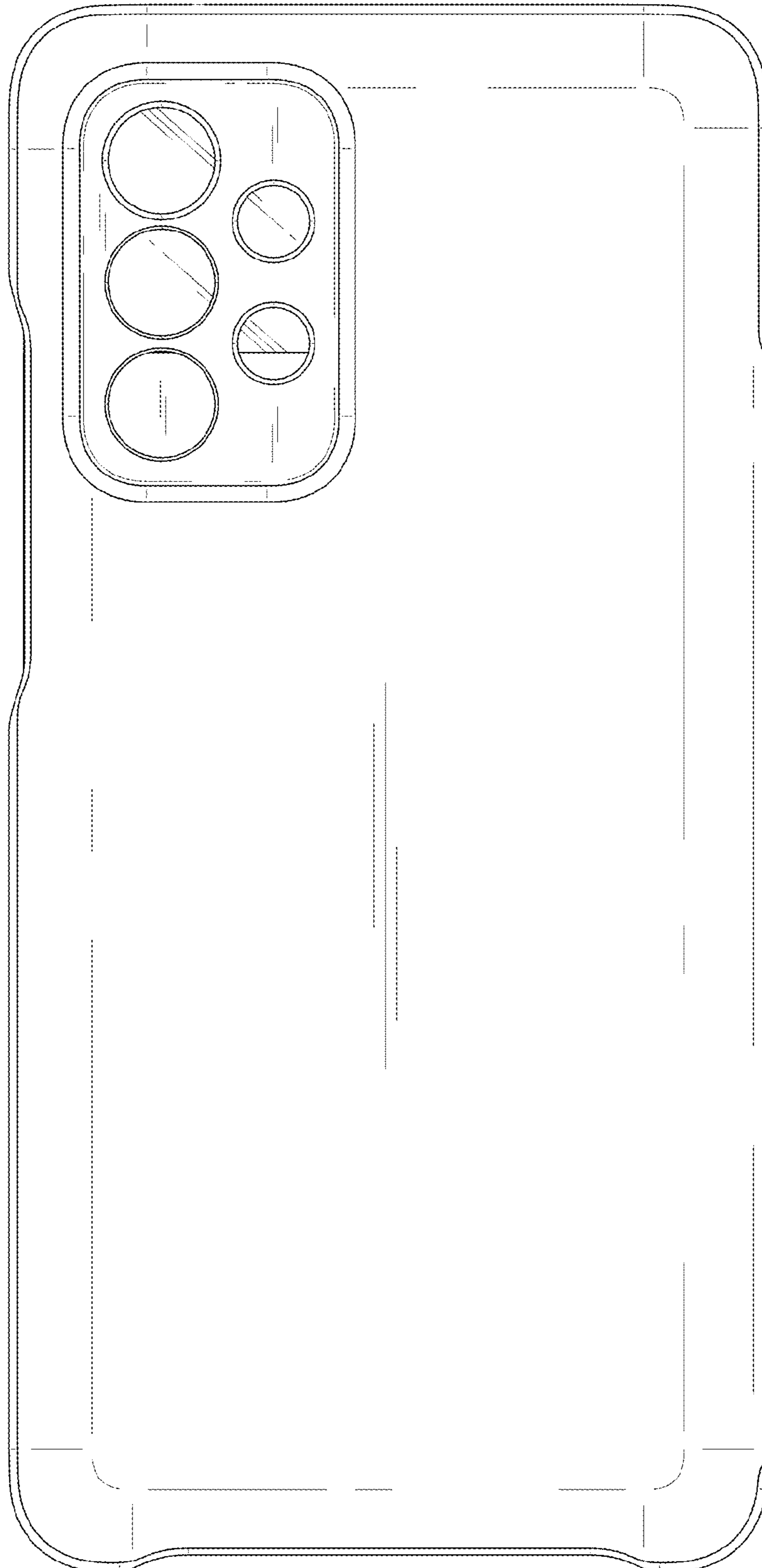

FIG. 4

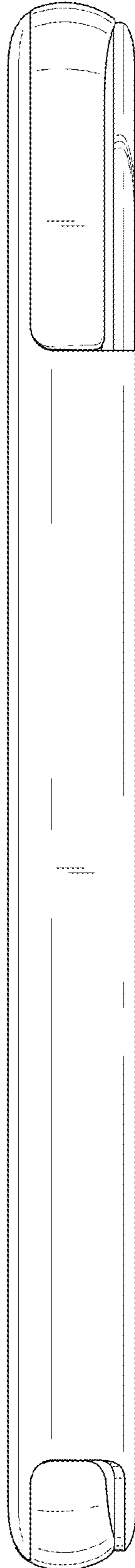

FIG. 5

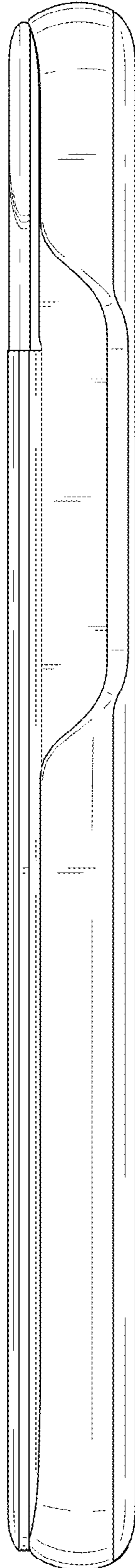

FIG. 6

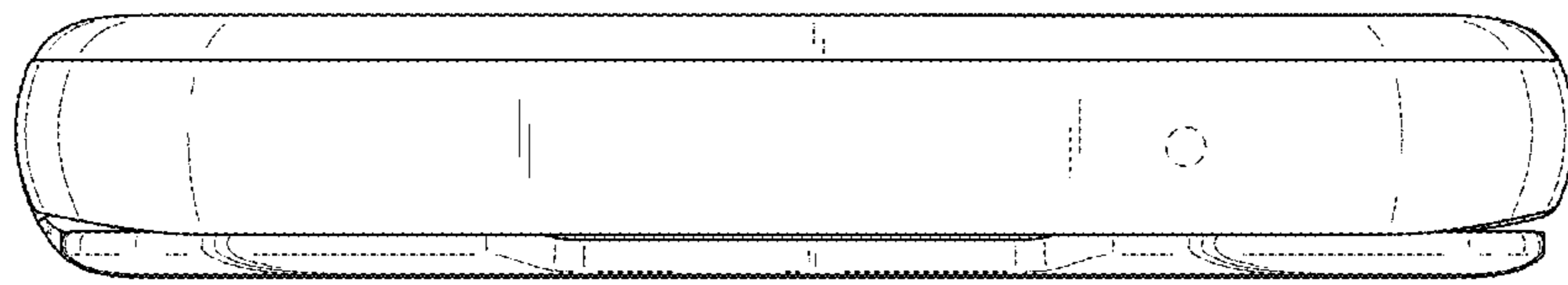



FIG. 7

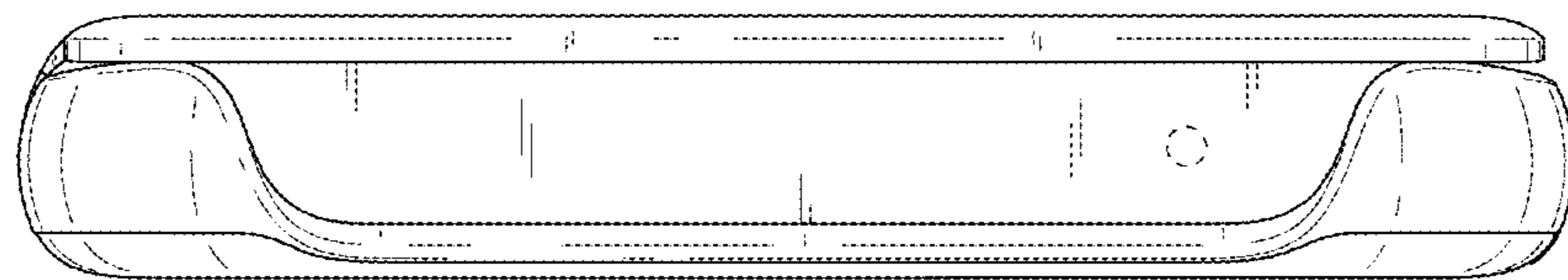

FIG. 8

