



US00D976249S

(12) **United States Design Patent**  
**Liu**

(10) **Patent No.:** **US D976,249 S**  
(45) **Date of Patent:** **\*\* Jan. 24, 2023**

(54) **MOBILE PHONE CASE**

(71) Applicant: **Huixiong Liu**, Guangdong (CN)

(72) Inventor: **Huixiong Liu**, Guangdong (CN)

(\*\*) Term: **15 Years**

(21) Appl. No.: **29/773,685**

(22) Filed: **Mar. 11, 2021**

(30) **Foreign Application Priority Data**

Jan. 11, 2021 (CN) ..... 202130017356.7

(51) **LOC (14) Cl.** ..... **14-03**

(52) **U.S. Cl.**  
USPC ..... **D14/250; D14/341**

(58) **Field of Classification Search**  
USPC ..... D3/201, 215, 218, 233, 247, 249, 267,  
D3/269, 273, 300, 303, 307, 323;  
D10/104.1, 50, 65, 74; D14/238, 238.1,  
D14/341, 342, 343, 344, 345, 346, 347,  
D14/426, 240, 447, 451, 440, 432-434,  
D14/452, 130, 496, 137, 138 R, 138 AA,  
D14/138 C, 138 G, 140, 140.8, 140.9,  
D14/140.11, 148, 147, 151, 203.1,  
D14/203.3-203.7, 209.1, 217, 218, 247,  
D14/248, 250, 251-253, 388, 389, 439,  
D14/482; D12/415, 410, 193; D13/103,  
D13/107-108, 156, 123, 133, 154, 158,  
D13/160, 173, 178, 184, 199;

(Continued)

(56) **References Cited**

**U.S. PATENT DOCUMENTS**

D726,170 S \* 4/2015 Ng ..... D14/250  
D766,885 S \* 9/2016 Armstrong ..... D14/250  
D786,192 S \* 5/2017 Liu ..... D13/107

(Continued)

**FOREIGN PATENT DOCUMENTS**

CN 303783680 \* 8/2016  
CN 306185509 \* 11/2020

**OTHER PUBLICATIONS**

SaharaCase—Kickstand with Belt Clip Case for Apple iPhone 13 Pro Max—Black, date not known [online], retrieved Aug. 22, 2022, retrieved from the internet: <<https://www.bestbuy.com/site/saharacase-kickstand-with-belt-clip-case-for-apple-iphone-13-pro-max-black/6478778.p?>> (Year: 2022).\*

(Continued)

*Primary Examiner* — Messina L Smith  
*Assistant Examiner* — Rodolfo Castro, Jr.

(57) **CLAIM**

The ornamental design for a mobile phone case, as shown and described.

**DESCRIPTION**

FIG. 1 is a top, front and right side perspective view of a mobile phone case showing my new design;  
FIG. 2 is a bottom, rear and left side perspective view thereof;  
FIG. 3 is a front elevational view thereof;  
FIG. 4 is a rear elevational view thereof;  
FIG. 5 is a left side view thereof;  
FIG. 6 is a right side view thereof;  
FIG. 7 is a top plan view thereof;  
FIG. 8 is a bottom plan view thereof; and,  
FIG. 9 is an enlarged view of the portion of the mobile phone case shown in the area designated as 9 in FIG. 1.  
The broken lines in the drawings illustrate portions of the mobile phone case that form no part of the claimed design. The broken lines encircling enlargement portions of the mobile phone case in FIG. 1 and illustrated in the enlarged view in FIG. 9 form no part of the claimed design.

**1 Claim, 9 Drawing Sheets**

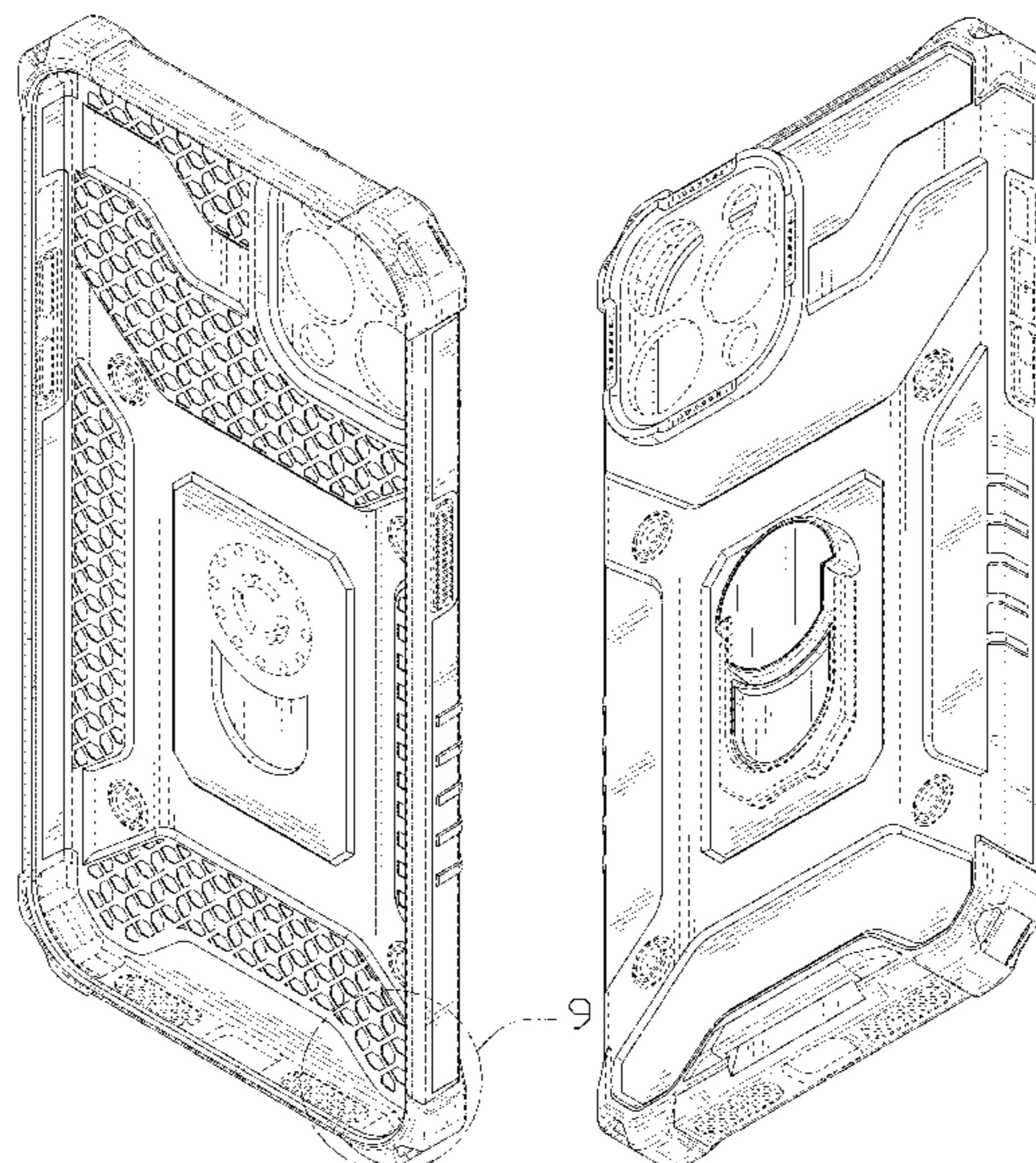

(58) **Field of Classification Search**

USPC ..... D18/4.4-4.6, 6, 7; D21/186, 330, 332,  
 D21/324, 329  
 CPC ..... G06F 3/041; G06F 3/0412; G06F 3/0416;  
 G06F 3/0488; G06F 3/04883; G06F  
 3/04886; G06F 1/1613; G06F 1/1624;  
 G06F 1/1626; G06F 1/1633; G06F  
 1/1641; G06F 1/1643; G06F 1/1692;  
 G06F 2200/1633; G06F 2212/1721; G09F  
 1/12; G09F 1/00; G09F 2007/1843; G09F  
 2013/1881; H04B 1/3888; H04B 1/3833;  
 H04B 1/04; H04B 1/03; H04B 1/08;  
 A45C 13/02; A45C 13/002; A45C  
 13/185; A45C 2011/002; A45C 1/06;  
 A45F 2005/1006; A45F 2200/0516; A45F  
 2200/0525; A47G 1/0605; A63H 33/3016  
 See application file for complete search history.

(56) **References Cited**

U.S. PATENT DOCUMENTS

D794,625 S \* 8/2017 Armstrong ..... D14/440  
 D806,083 S \* 12/2017 Armstrong ..... D14/440  
 D807,335 S \* 1/2018 Kitade ..... D14/341  
 D808,369 S \* 1/2018 Kim ..... D14/250  
 D811,379 S \* 2/2018 Armstrong ..... D14/250  
 D828,320 S \* 9/2018 Tschopp ..... D14/138 G

D831,018 S \* 10/2018 Kim ..... D14/250  
 D850,456 S \* 6/2019 Armstrong ..... D14/440  
 10,329,083 B1 \* 6/2019 Chuang ..... B62J 23/00  
 D856,956 S \* 8/2019 Liu ..... D14/250  
 D862,446 S \* 10/2019 Jia ..... D14/250  
 D865,740 S \* 11/2019 Altschul ..... D14/250  
 D876,420 S \* 2/2020 Armstrong ..... D14/250  
 D876,422 S \* 2/2020 Armstrong ..... D14/250  
 D892,727 S \* 8/2020 Gan ..... D13/103  
 D901,480 S \* 11/2020 Altschul ..... H04M 1/0279  
 D14/250  
 D904,385 S \* 12/2020 Weng ..... D14/250  
 D906,317 S \* 12/2020 Kim ..... D14/250  
 D908,685 S \* 1/2021 Bai ..... D14/250  
 D910,026 S \* 2/2021 Li ..... D14/440  
 D923,616 S \* 6/2021 Xie ..... D14/250  
 D932,478 S \* 10/2021 Zhou ..... D14/250  
 D934,226 S \* 10/2021 Zhang ..... D14/250  
 D944,256 S \* 2/2022 Cheng ..... D14/440  
 2013/0273944 A1 \* 10/2013 Wilson ..... H04W 4/90  
 455/457  
 2017/0353207 A1 \* 12/2017 Chou ..... H04B 1/3888

OTHER PUBLICATIONS

Jincalu for iPhone 13 Pro Max Case with Slide Camera Cover, Jan. 26, 2022 [online], retrieved Aug. 22, 2022, retrieved from the internet: <[https://www.amazon.com/dp/B09PTJ436Y/ref=sspa\\_dk\\_detail\\_3?](https://www.amazon.com/dp/B09PTJ436Y/ref=sspa_dk_detail_3?)> (Year: 2022).\*

\* cited by examiner

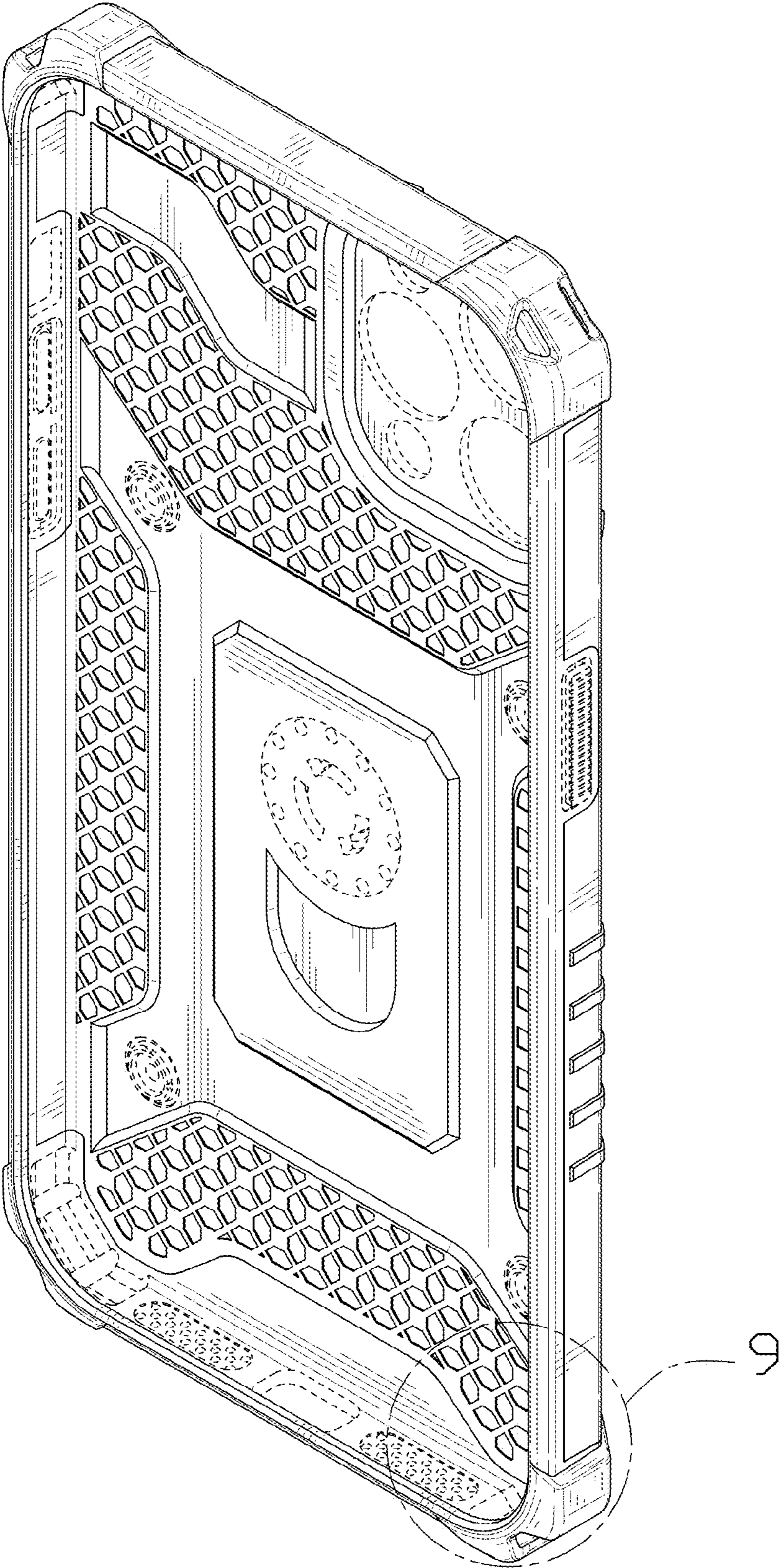

FIG. 1

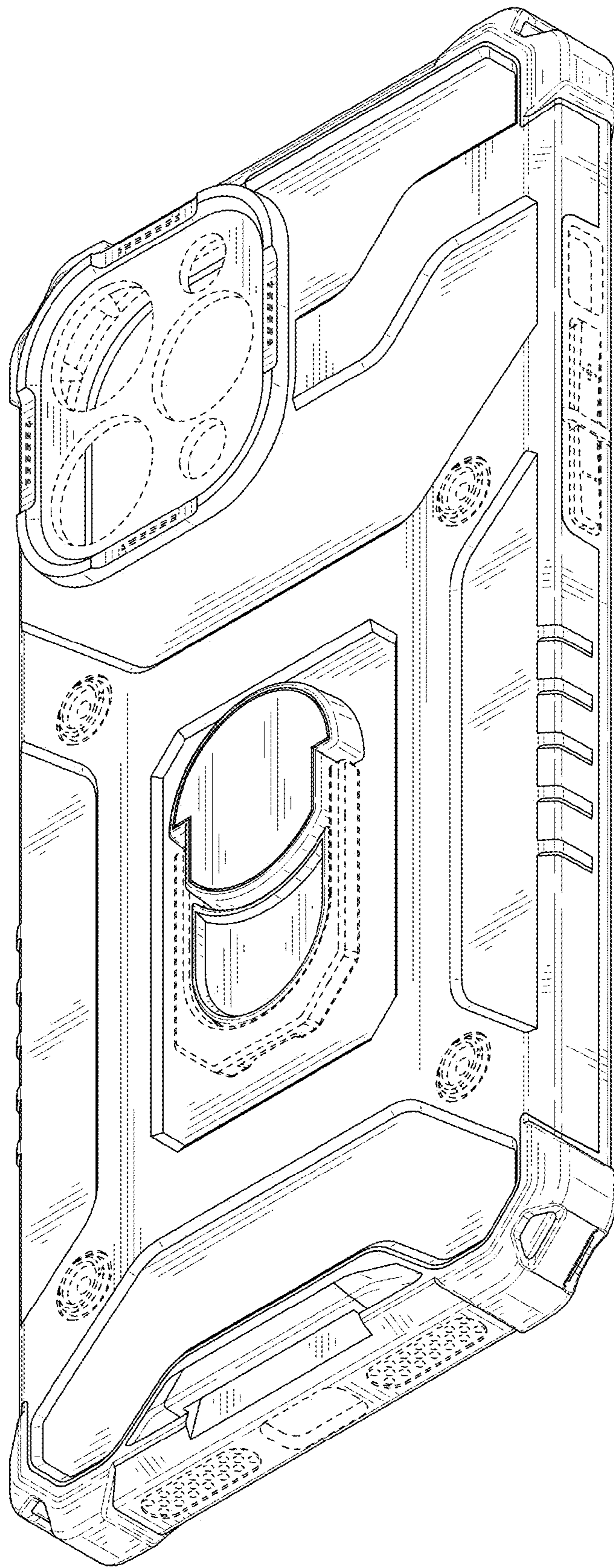

FIG. 2

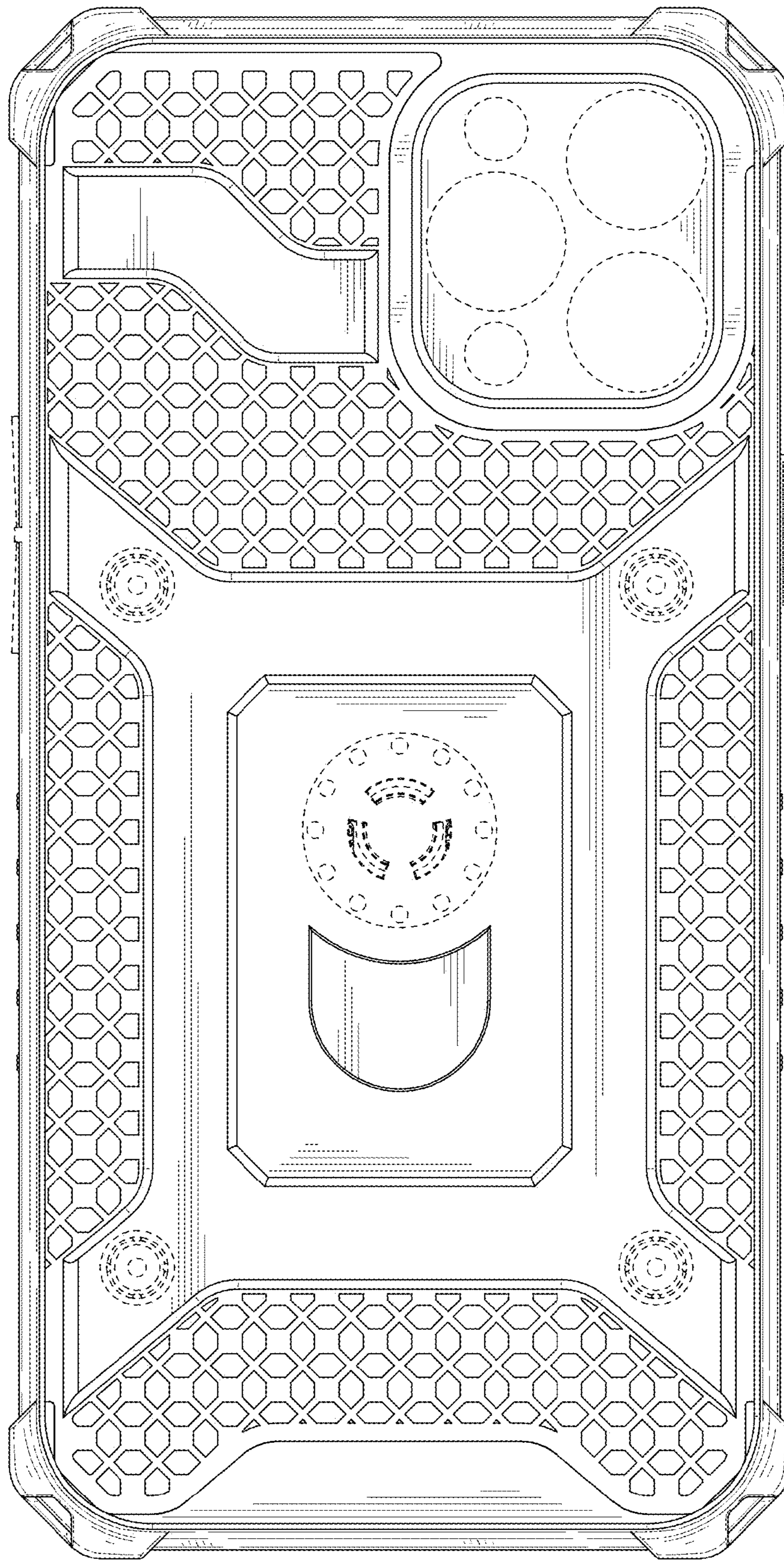

FIG. 3

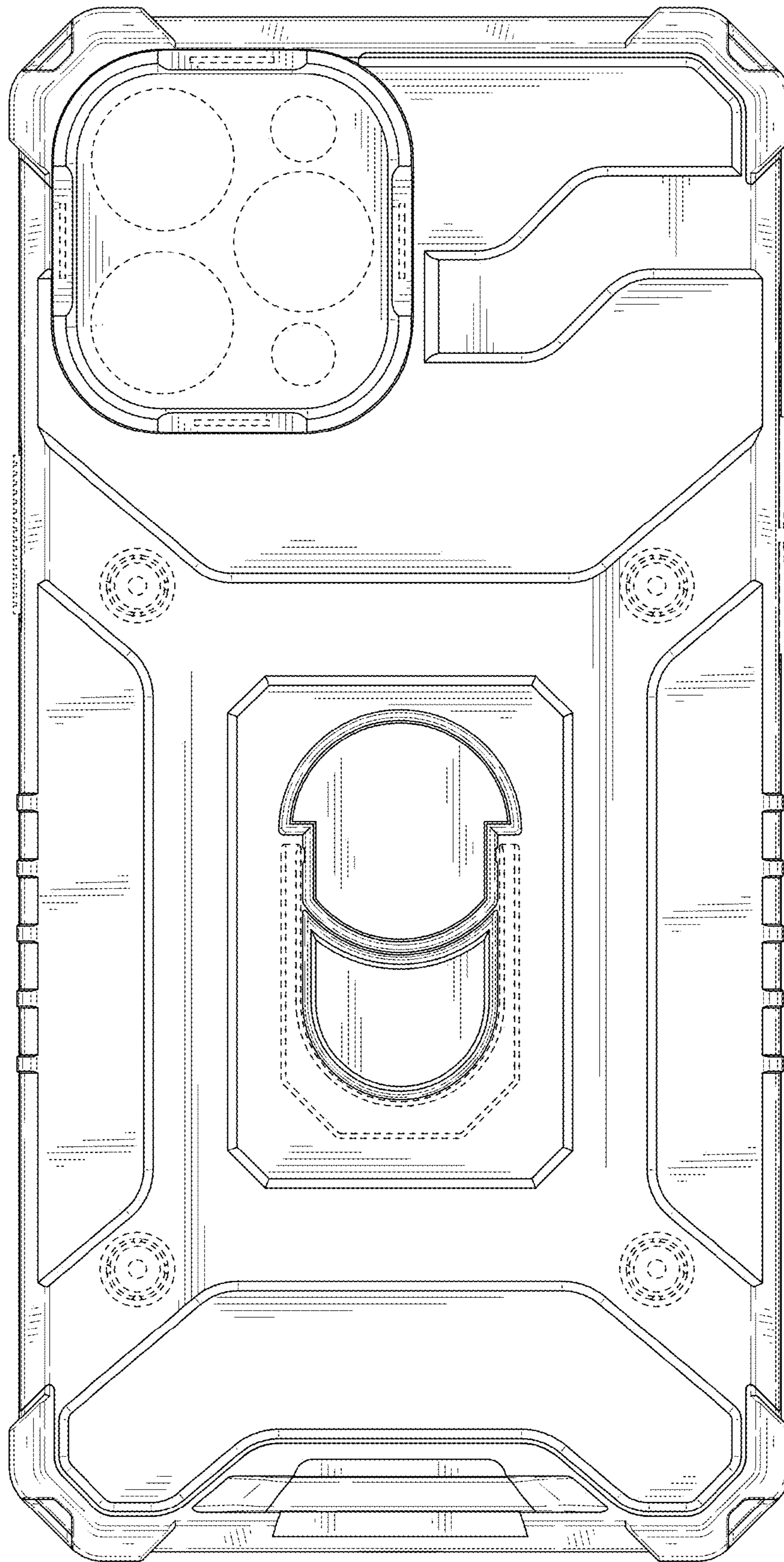

FIG. 4

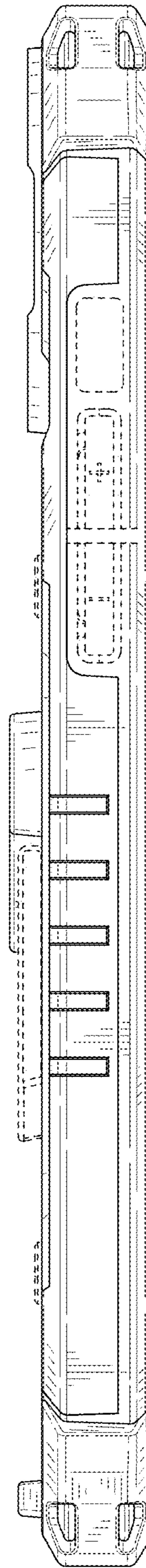

FIG. 5

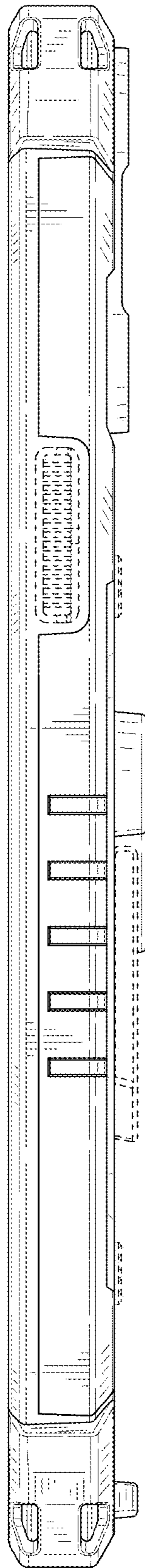

FIG. 6



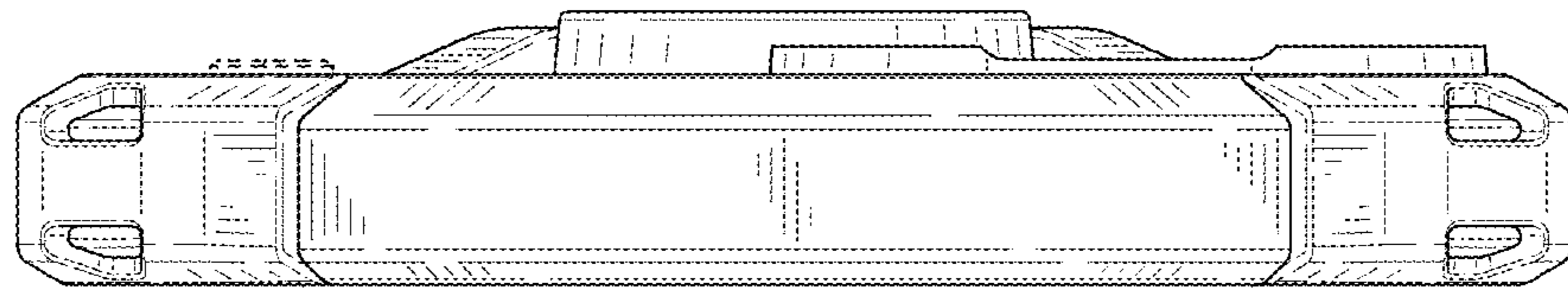

FIG. 7

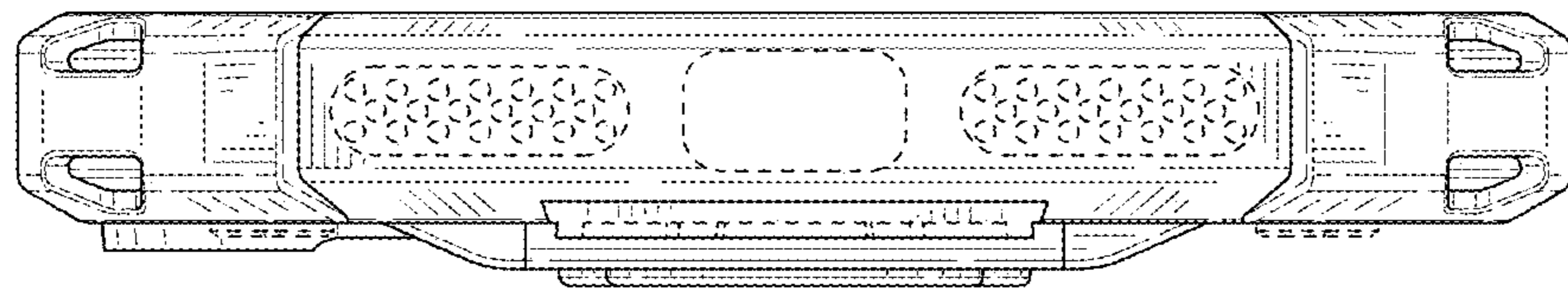

FIG. 8

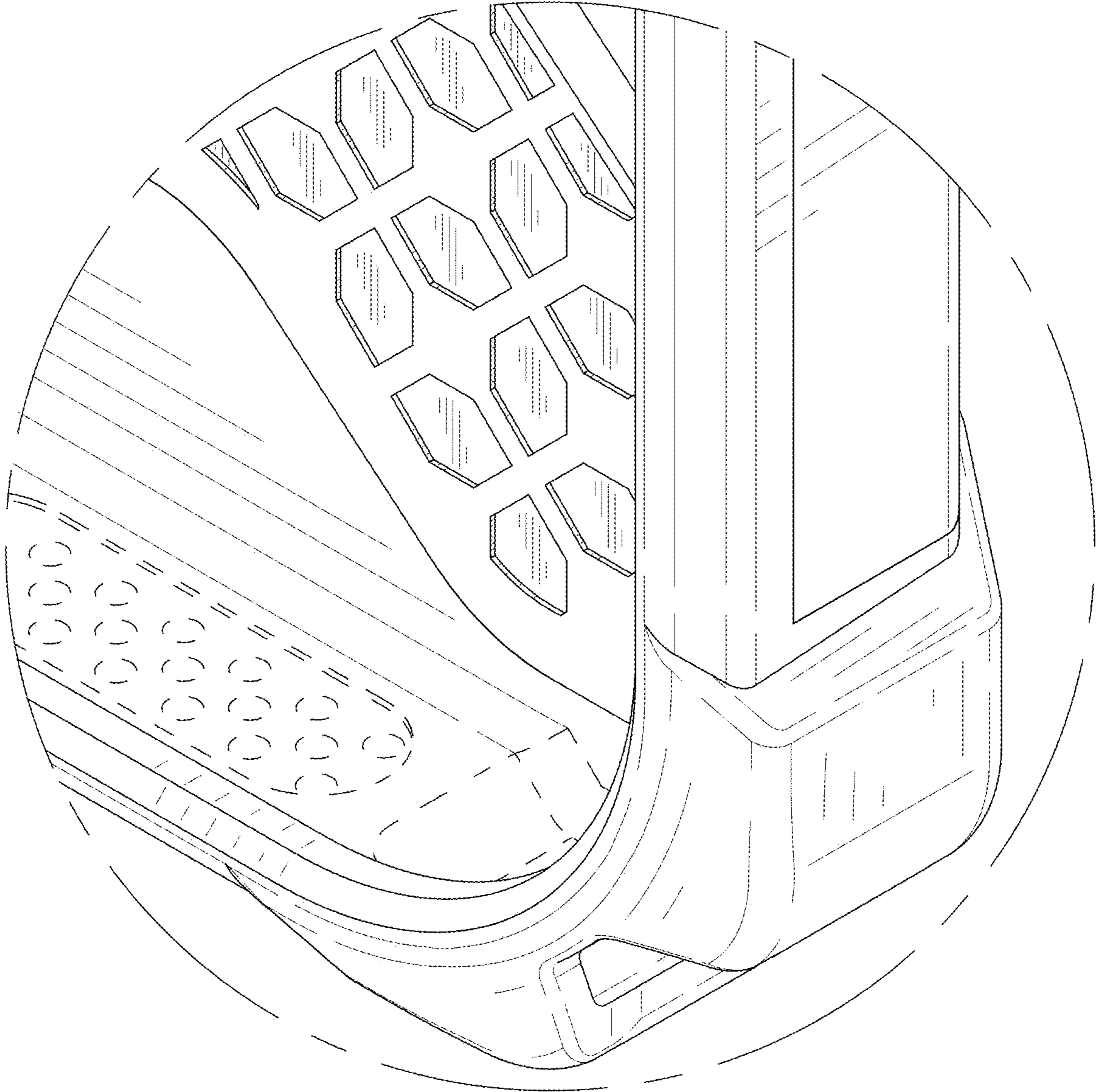

FIG. 9