



US00D976200S

(12) **United States Design Patent**
Li

(10) **Patent No.:** **US D976,200 S**
(45) **Date of Patent:** **** Jan. 24, 2023**

- (54) **CHARGER**
- (71) Applicant: **Jiang Li**, Guangdong (CN)
- (72) Inventor: **Jiang Li**, Guangdong (CN)
- (**) Term: **15 Years**
- (21) Appl. No.: **29/795,924**
- (22) Filed: **Jun. 22, 2021**
- (51) **LOC (14) Cl.** **13-02**
- (52) **U.S. Cl.**
USPC **D13/107**
- (58) **Field of Classification Search**
USPC D13/107-108, 110, 118-119, 184, 199;
D14/251, 253, 432-434, 447
CPC H02J 7/025; H02J 7/005; H02J 7/02; H02J
7/0026; H02J 7/0042; H02J 7/0044; H02J
7/0045; H02J 7/13; H02J 7/0003
See application file for complete search history.

(56) **References Cited**

U.S. PATENT DOCUMENTS

D327,247 S *	6/1992	Higuchi	D13/108
D349,485 S *	8/1994	Richards	D13/107
D397,084 S *	8/1998	Siddoway	D13/107
D472,875 S *	4/2003	Garvis	D13/107
D505,913 S *	6/2005	Kam Lun	D13/107

D506,972 S *	7/2005	Parel	D13/107
D507,234 S *	7/2005	Heun	D13/107
D548,687 S *	8/2007	Okuda	D13/107
D562,230 S *	2/2008	Houghton	D13/107
D601,953 S *	10/2009	Asai	D13/107
D605,111 S *	12/2009	Schoch	D13/107
D721,648 S *	1/2015	Breines	D13/107
D723,458 S *	3/2015	Martinez	D13/108
D833,451 S *	11/2018	Paolizzi	D14/453
D840,926 S *	2/2019	Howell	D13/107
D868,074 S *	11/2019	Paolizzi	D14/453
D885,331 S *	5/2020	Suzuki	D13/108
D900,024 S *	10/2020	Kuang	D13/107
D900,025 S *	10/2020	Chen	D13/107

* cited by examiner

Primary Examiner — Rosemary K Tarcza

(57) **CLAIM**

The ornamental design for a charger, as shown.

DESCRIPTION

FIG. 1 is a front elevational view of a charger showing my new design;
 FIG. 2 is a left side view thereof;
 FIG. 3 is a right side view thereof;
 FIG. 4 is a top plan view thereof;
 FIG. 5 is a bottom plan view thereof;
 FIG. 6 is a perspective view thereof; and,
 FIG. 7 is another perspective view thereof.

1 Claim, 7 Drawing Sheets

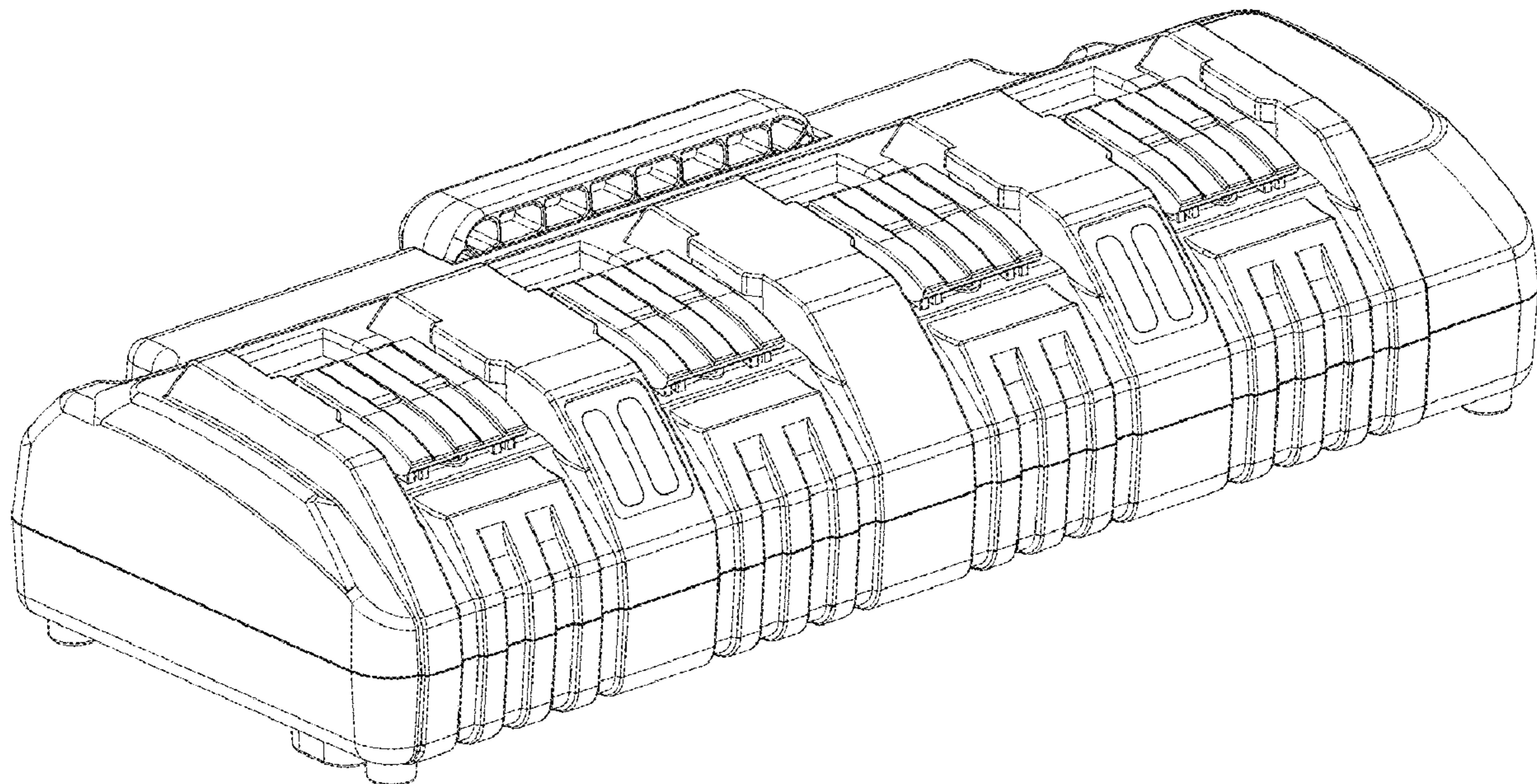

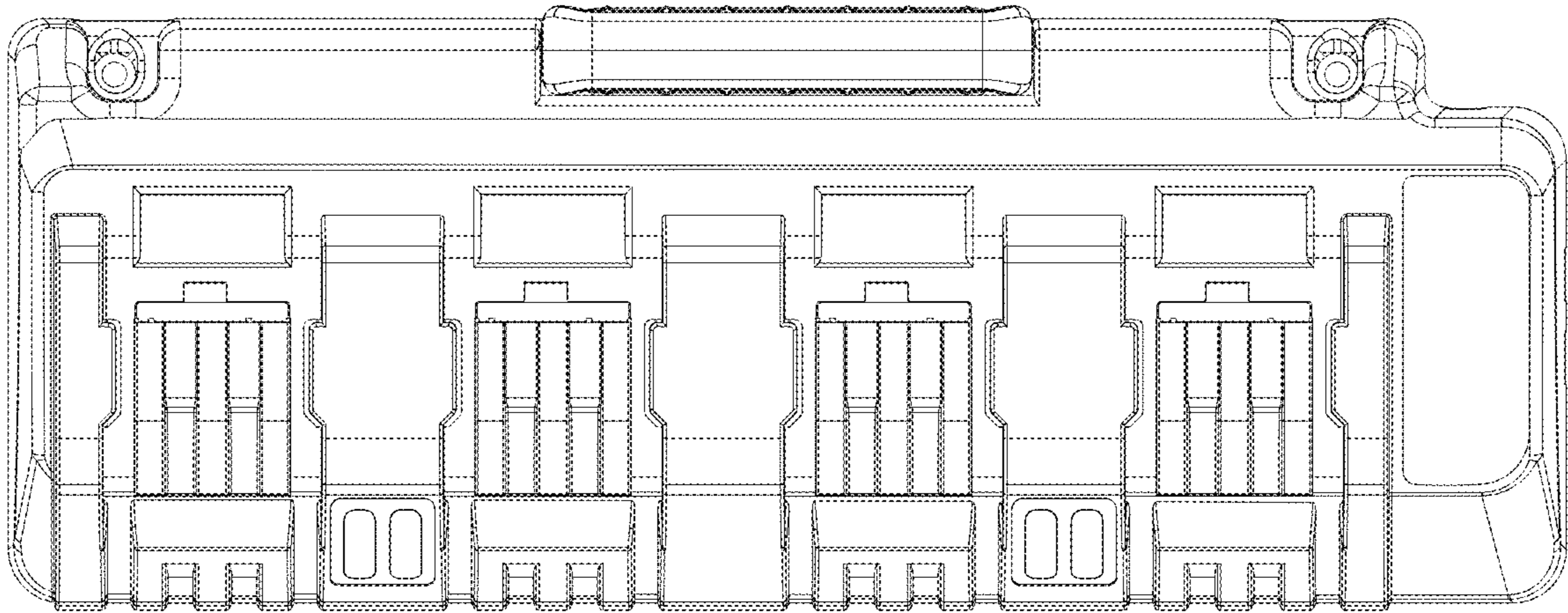

FIG. 1

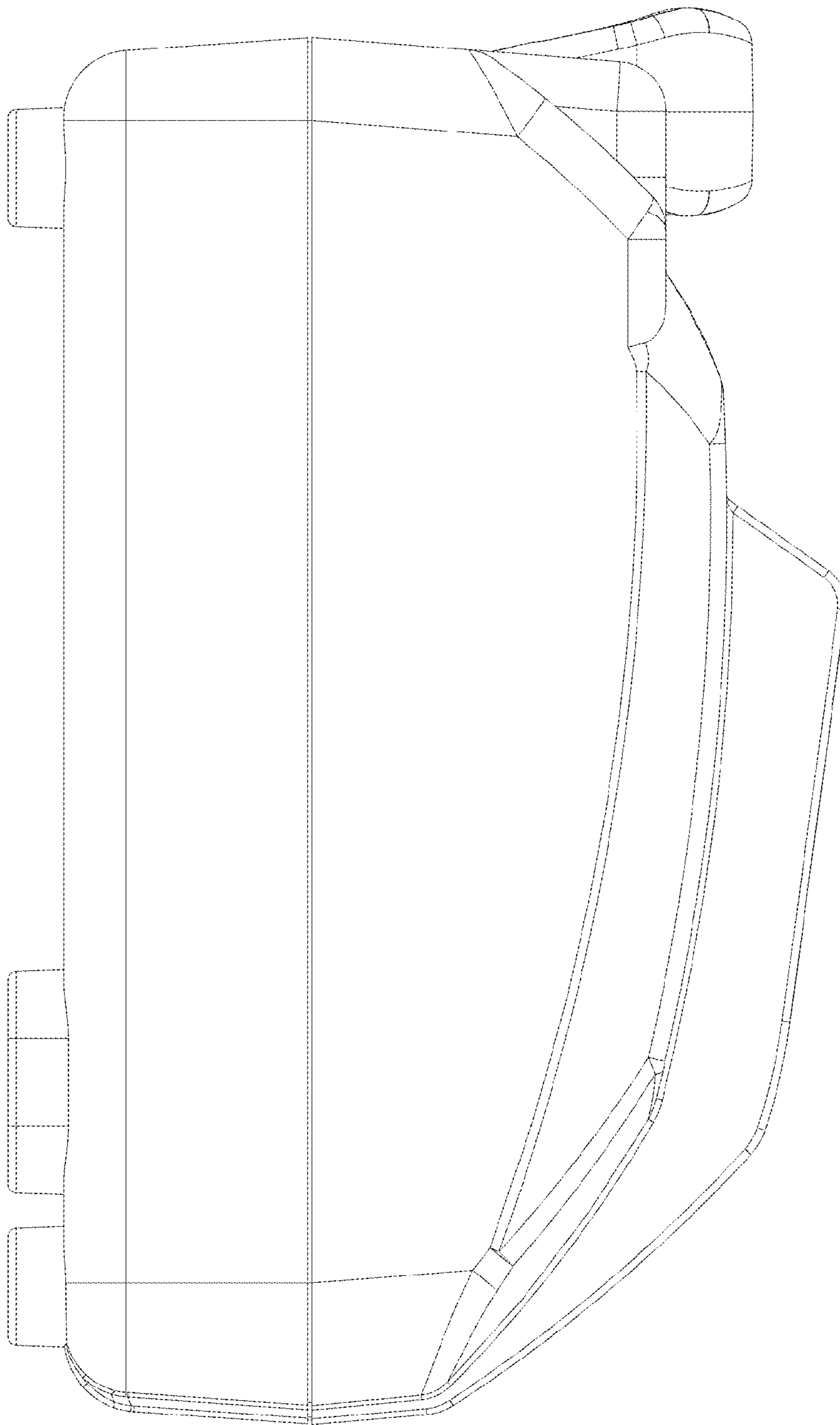

FIG. 2

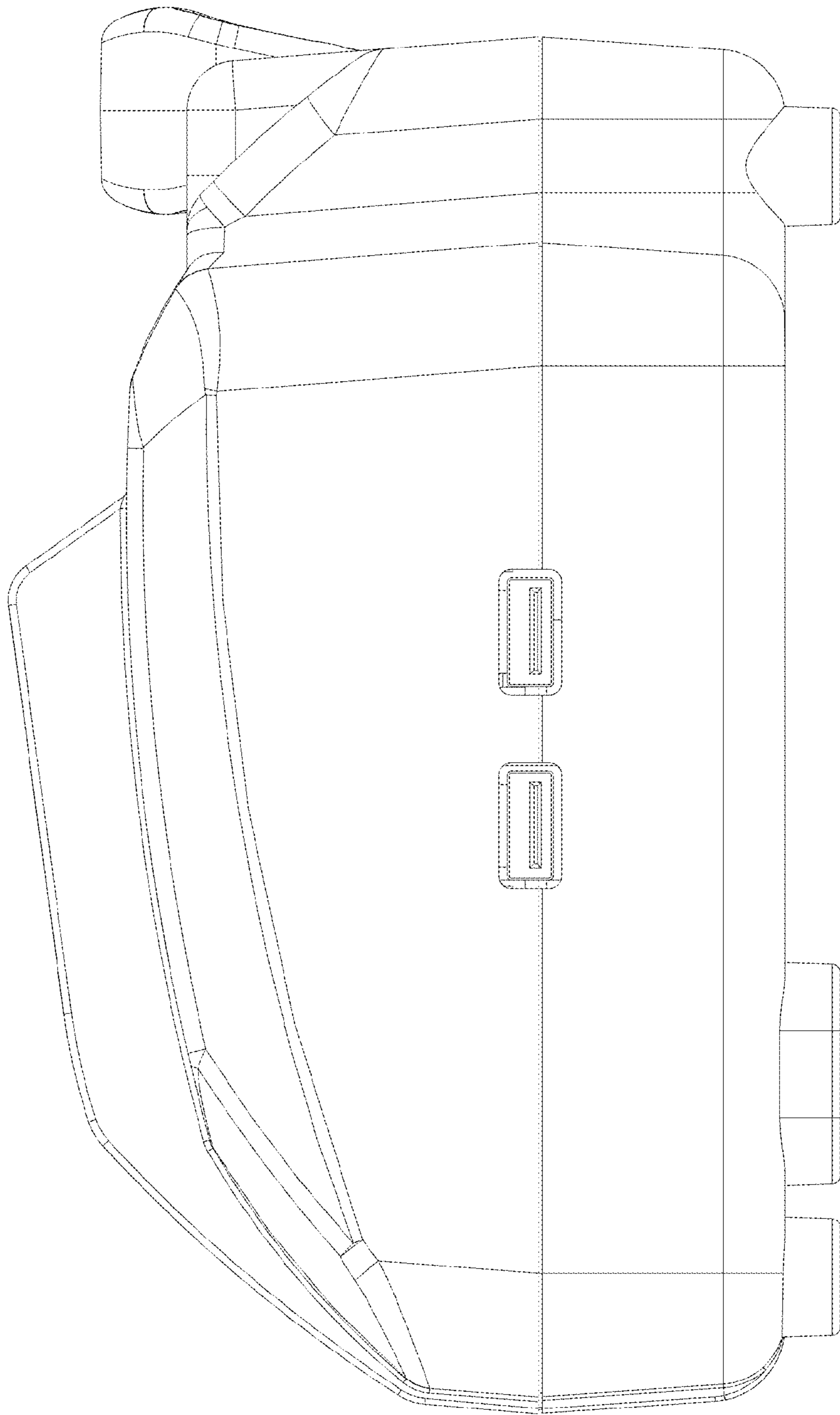

FIG. 3

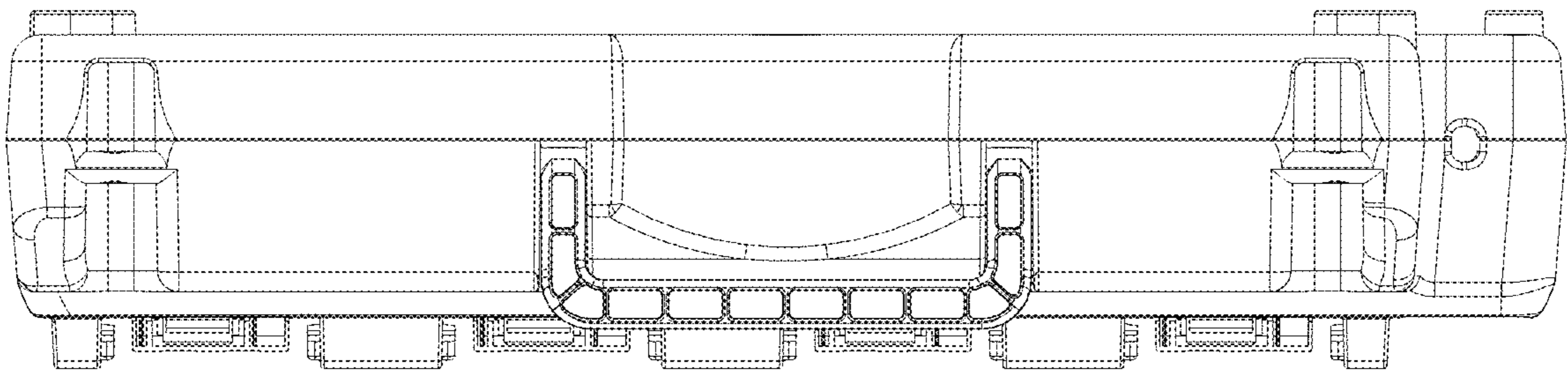

FIG. 4

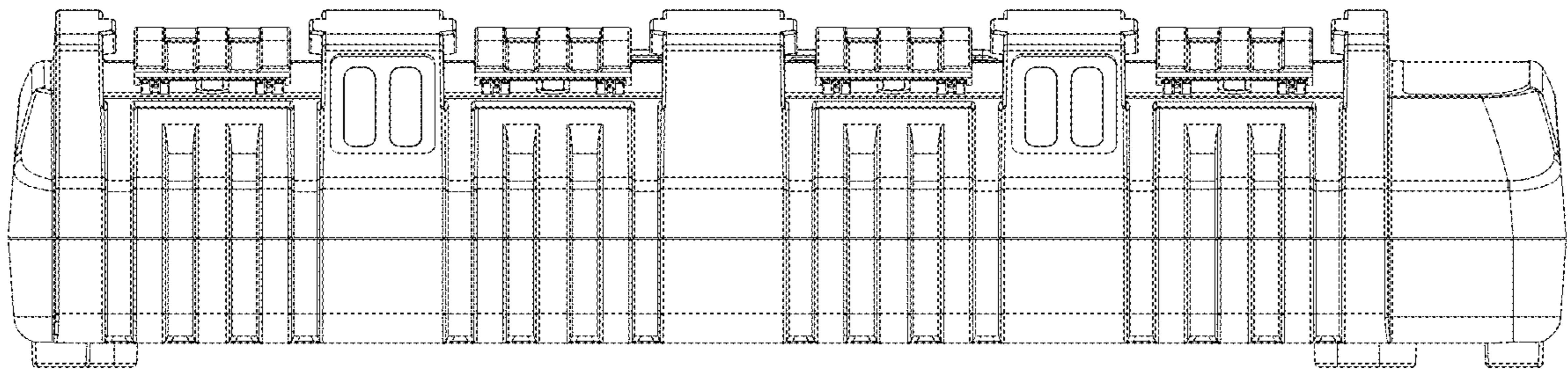

FIG. 5

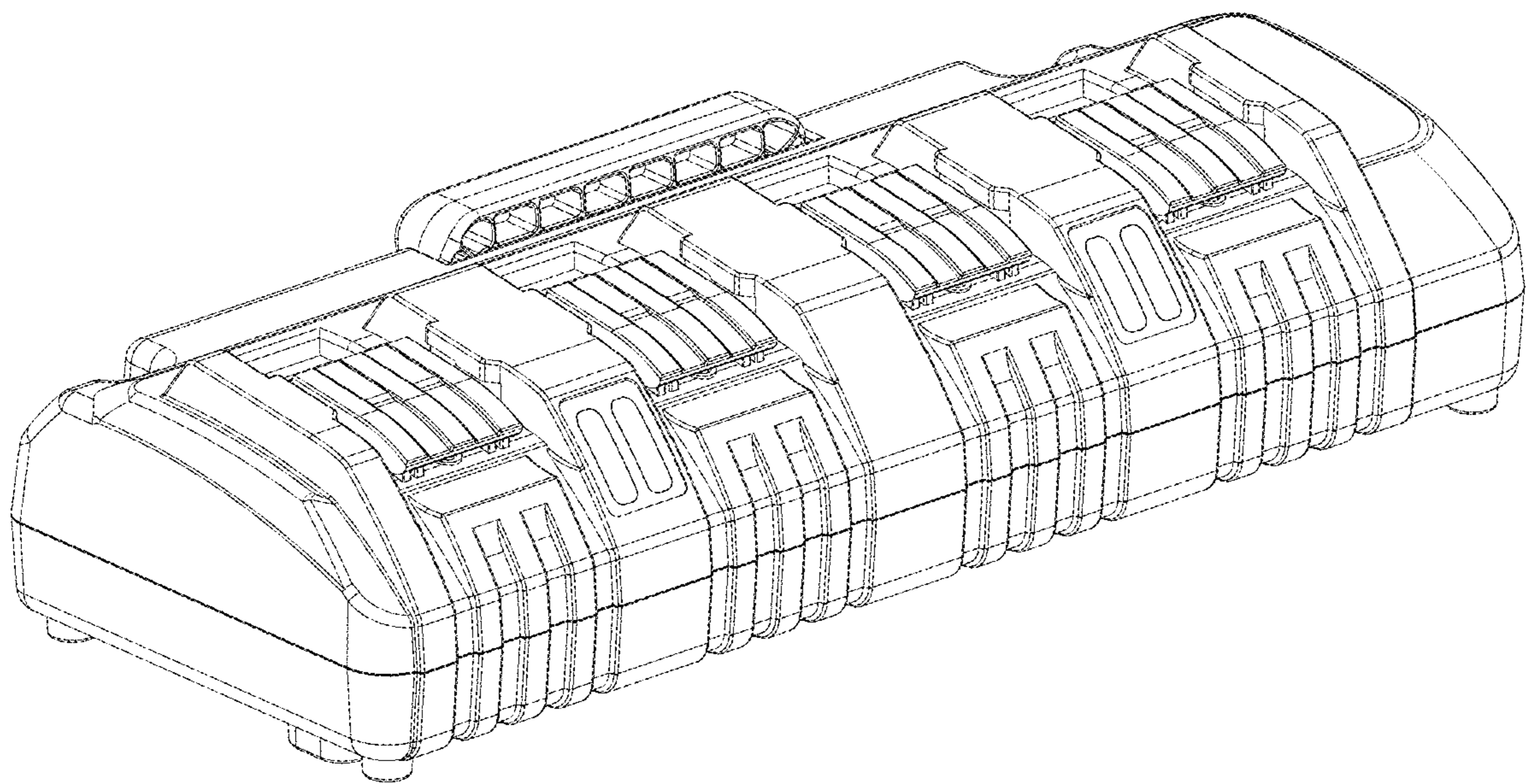

FIG. 6

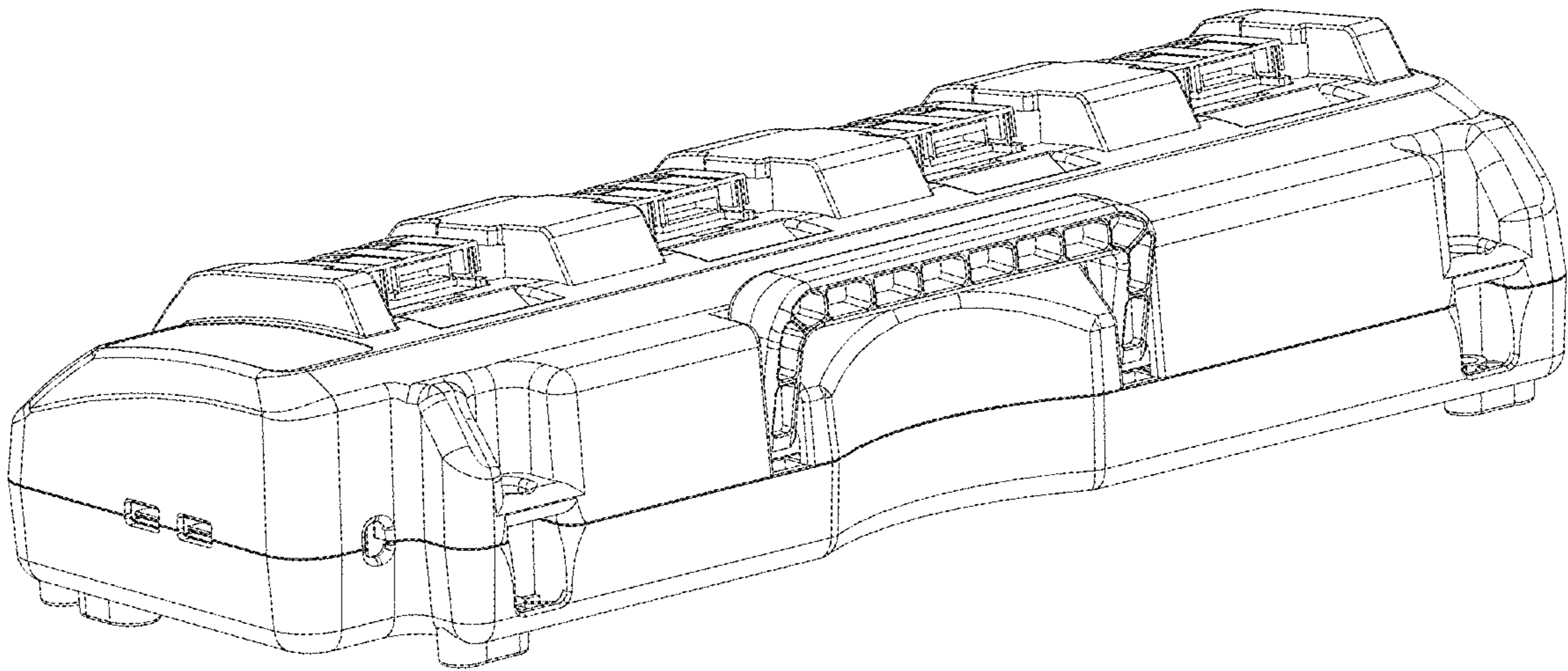

FIG. 7