



US00D976159S

(12) **United States Design Patent**
Nunn et al.

(10) **Patent No.:** **US D976,159 S**
(45) **Date of Patent:** **** Jan. 24, 2023**

(54) **MOTORCYCLE AND/OR REPLICA THEREOF**

(71) Applicant: **ASTON MARTIN LAGONDA LIMITED**, Warwick (GB)

(72) Inventors: **Julian Nunn**, Warwick (GB); **Adam MacKerron**, Warwick (GB)

(73) Assignee: **ASTON MARTIN LAGONDA LIMITED**, Gaydon (GB)

(**) Term: **15 Years**

(21) Appl. No.: **29/780,380**

(22) Filed: **Apr. 23, 2021**

(30) **Foreign Application Priority Data**

Oct. 23, 2020 (EM) 008212963-0001

(51) **LOC (14) Cl.** **12-11**

(52) **U.S. Cl.**
USPC **D12/110**

(58) **Field of Classification Search**
USPC D12/110, 111, 117; D21/432, 538
CPC B62K 11/00; B62K 11/02; B62K 11/04;
B62K 11/10; B62K 17/00; B62K 19/00;
B62K 2202/00
See application file for complete search history.

(56) **References Cited**

U.S. PATENT DOCUMENTS

D606,906 S *	12/2009	Chosa	D12/110
D611,881 S *	3/2010	Toriyama	D12/110
D643,341 S *	8/2011	Uchiyama	D12/110
D647,825 S *	11/2011	Shibuta	D12/110
D670,204 S *	11/2012	Yasuhara	D12/110
D686,538 S *	7/2013	Nagao	D12/110
D688,982 S *	9/2013	Oyanagi	D12/110
D689,406 S *	9/2013	Yasuhara	D12/110
D755,084 S *	5/2016	Sakata	D12/110
D755,680 S *	5/2016	Yashuhara	D12/110

D755,681 S *	5/2016	Martin	D12/110
D755,682 S *	5/2016	Hahn-Woernle	D12/110
D756,268 S *	5/2016	Yamada	D12/110
D758,923 S *	6/2016	Yamada	D12/110
D758,924 S *	6/2016	Tamura	D12/110
D782,368 S *	3/2017	Fujimoto	D12/110
D795,746 S *	8/2017	Akita	D12/110
D797,002 S *	9/2017	Toyama	D12/110

(Continued)

OTHER PUBLICATIONS

“2021 Ninja® ZX™—10RR.” kawasaki., Nov. 23, 2020 [online], [retrieved on Aug. 26, 2022]. Retrieved from the Internet <URL: https://www.kawasaki.com/en-us/motorcycle/ninja/supersport/ninja-zx-10r/2021-ninja-zx-10rr?cm_re=CATEGORY:MOTORCYCLE_-CATEGORYVEHICLES_-VEHICLEBUCKET>.*

(Continued)

Primary Examiner — Darlington Ly

(74) *Attorney, Agent, or Firm* — Dorsey & Whitney LLP

(57) **CLAIM**

We claim the ornamental design for a motorcycle and/or replica thereof, substantially as shown and described.

DESCRIPTION

FIG. 1 is a front and right side perspective view of a motorcycle and/or replica thereof embodying our new design;
FIG. 2 is a rear and right side perspective view thereof;
FIG. 3 is a front elevation view thereof;
FIG. 4 is a rear elevation view thereof;
FIG. 5 is a right side elevation view thereof;
FIG. 6 is a left side elevation view thereof;
FIG. 7 is a top plan view thereof; and,
FIG. 8 is a bottom plan view thereof.
The broken lines in the drawings illustrate portions of the motorcycle and/or replica thereof that form no part of the claimed design.

1 Claim, 5 Drawing Sheets

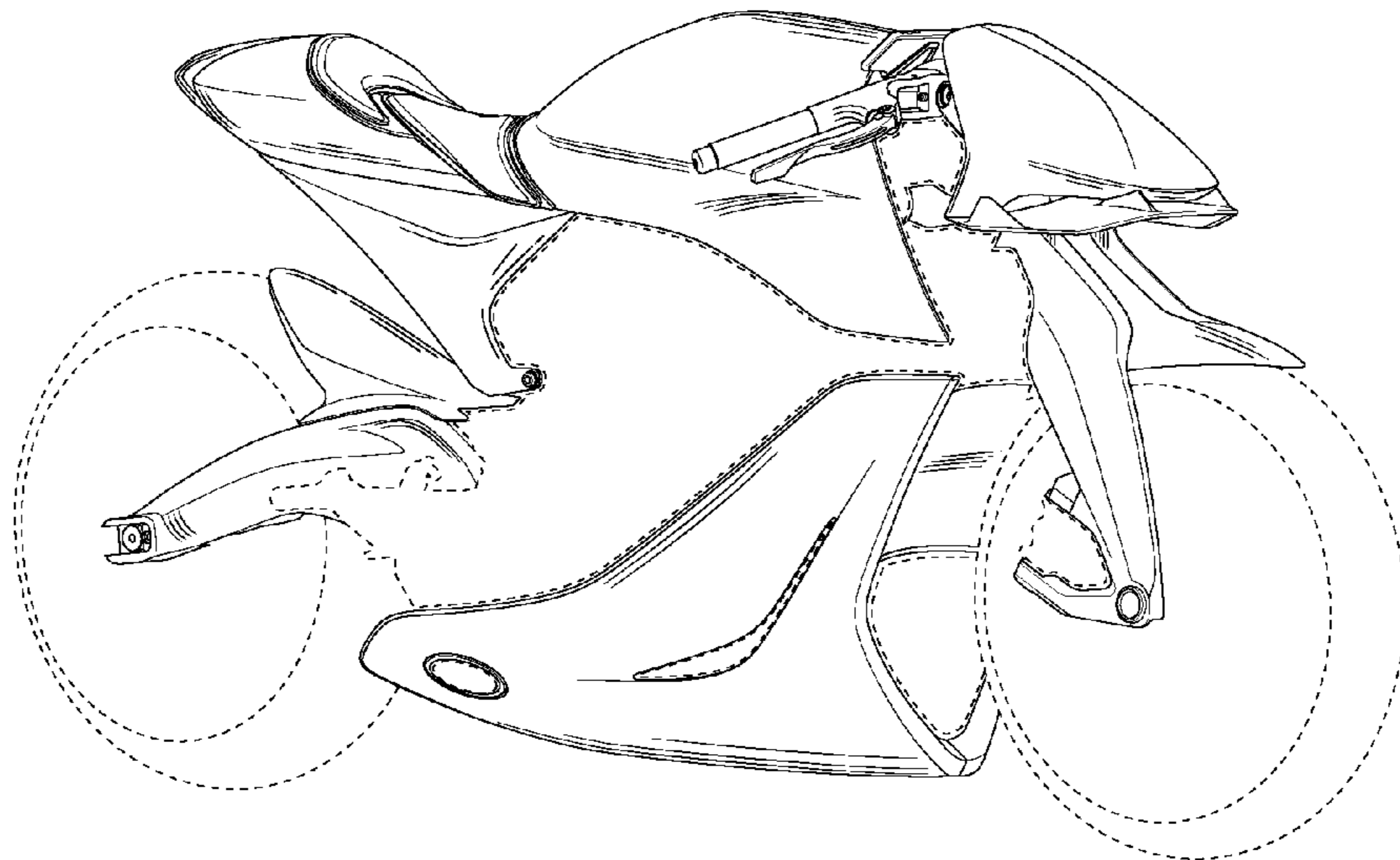

(56)

References Cited

U.S. PATENT DOCUMENTS

D797,608	S	*	9/2017	Tachibana	D12/110
D801,230	S	*	10/2017	Endo	D12/110
D807,231	S	*	1/2018	Petersson	D12/110
D815,566	S	*	4/2018	Oyanagi	D12/110
D817,230	S	*	5/2018	Tamura	D12/110
D821,269	S	*	6/2018	Sasanami	D12/110
D847,031	S	*	4/2019	Kobayashi	D12/110
D849,602	S	*	5/2019	Oyanagi	D12/110
D871,976	S	*	1/2020	Martin	D12/110
D874,985	S	*	2/2020	Shigihara	D12/110
D875,615	S	*	2/2020	Martin	D12/110
D875,616	S	*	2/2020	Martin	D12/110
D875,617	S	*	2/2020	Nagase	D12/110
D876,990	S	*	3/2020	Yoshitomi	D12/110
D884,562	S	*	5/2020	Usami	D12/110
D902,083	S	*	11/2020	Arru	D12/110
D911,223	S	*	2/2021	Kinoshita	D12/110

OTHER PUBLICATIONS

Jensen Beeler. "The 2021 Kawasaki Ninja ZX-10RR —\$29,000 & Only 500 Will Be Made." Asphalt & Rubber., Nov. 23, 2020 [online], [retrieved on Aug. 26, 2022]. Retrieved from the Internet <URL: <https://www.asphaltandrubber.com/bikes/2021-kawasaki-ninja-zx-10rr/>>.*

Ron Lieback. "2021 Kawasaki Ninja ZX-10R and ZX-10RR: All-New (15 Fast Facts)." Ultimate Motorcycling., Nov. 23, 2020 [online], [retrieved on Aug. 26, 2022]. Retrieved from the Internet <URL: <https://ultimatemotorcycling.com/2020/11/23/2021-kawasaki-ninja-zx-10r-and-zx-10rr-all-new-15-fast-facts/>>.*

Sagar Patil. "A turbo-charged, all-carbon-fiber machine bred for the track, made along with . . ." Top Speed., Nov. 11, 2019 [online], [retrieved on Aug. 26, 2022]. Retrieved from the Internet <URL: <https://www.topspeed.com/motorcycles/motorcycle-news/aston-martin-s-120-000-motorcycle-the-amb-001-ar186990.html>>.*

* cited by examiner

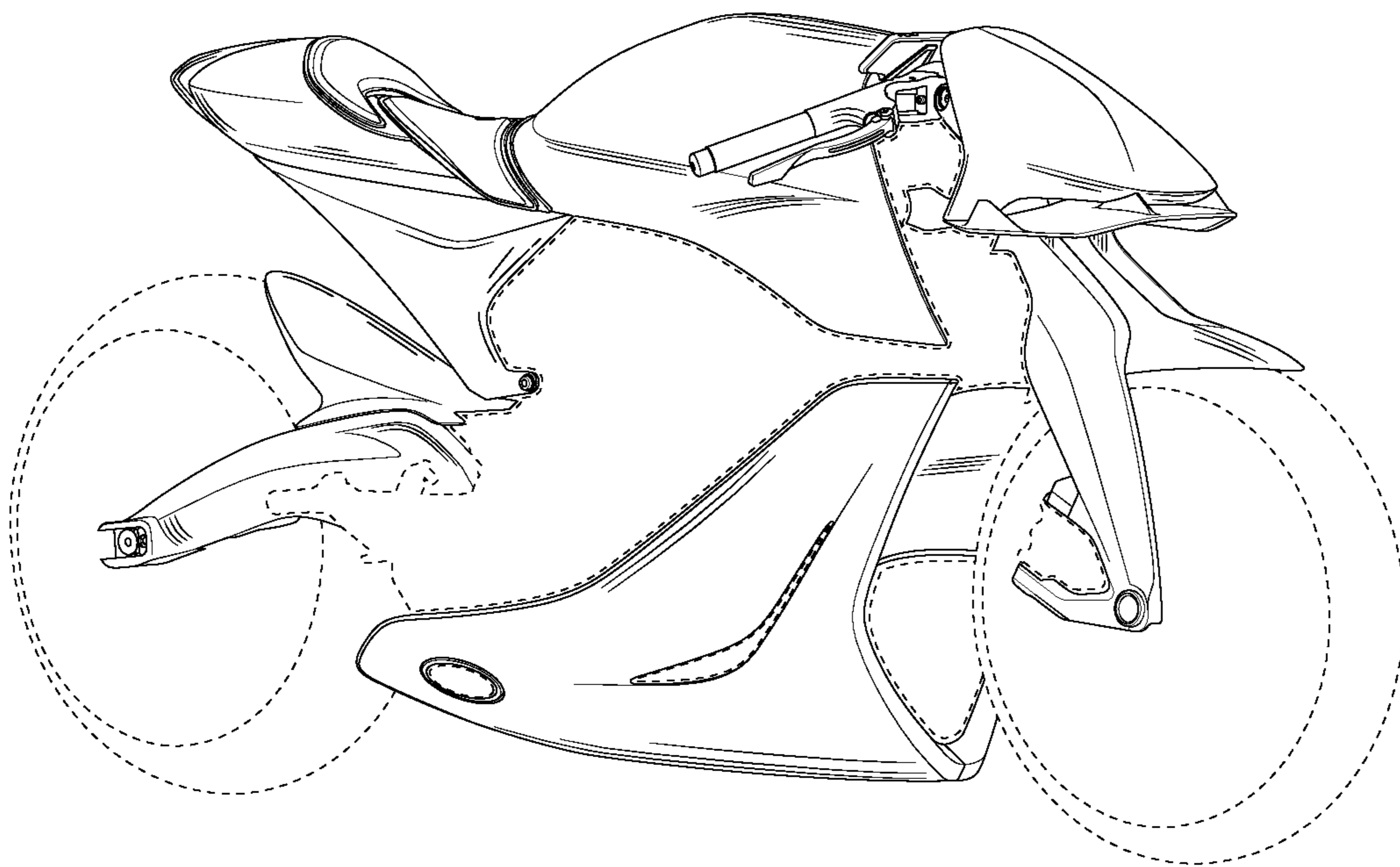

FIG. 1

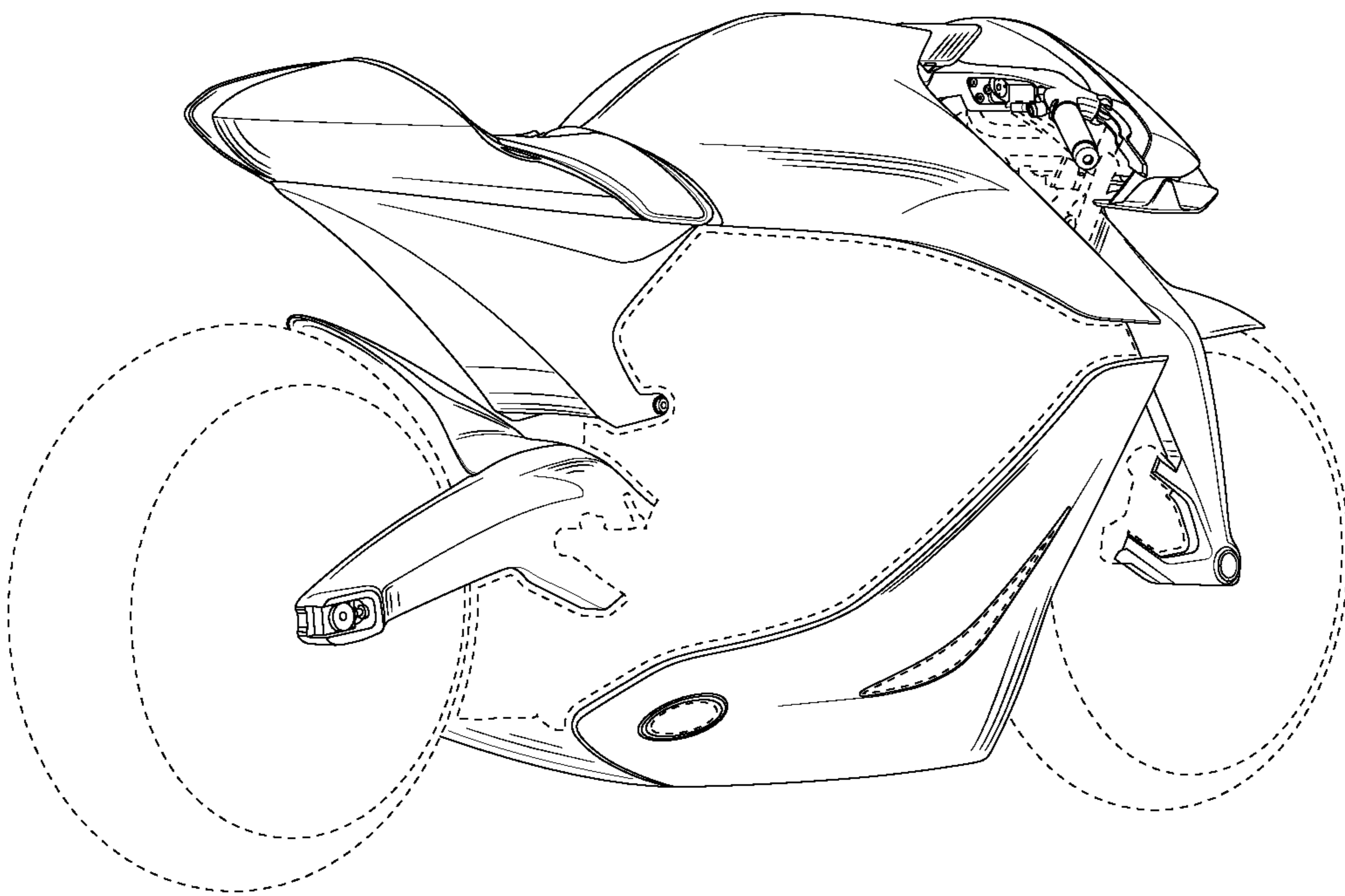

FIG. 2

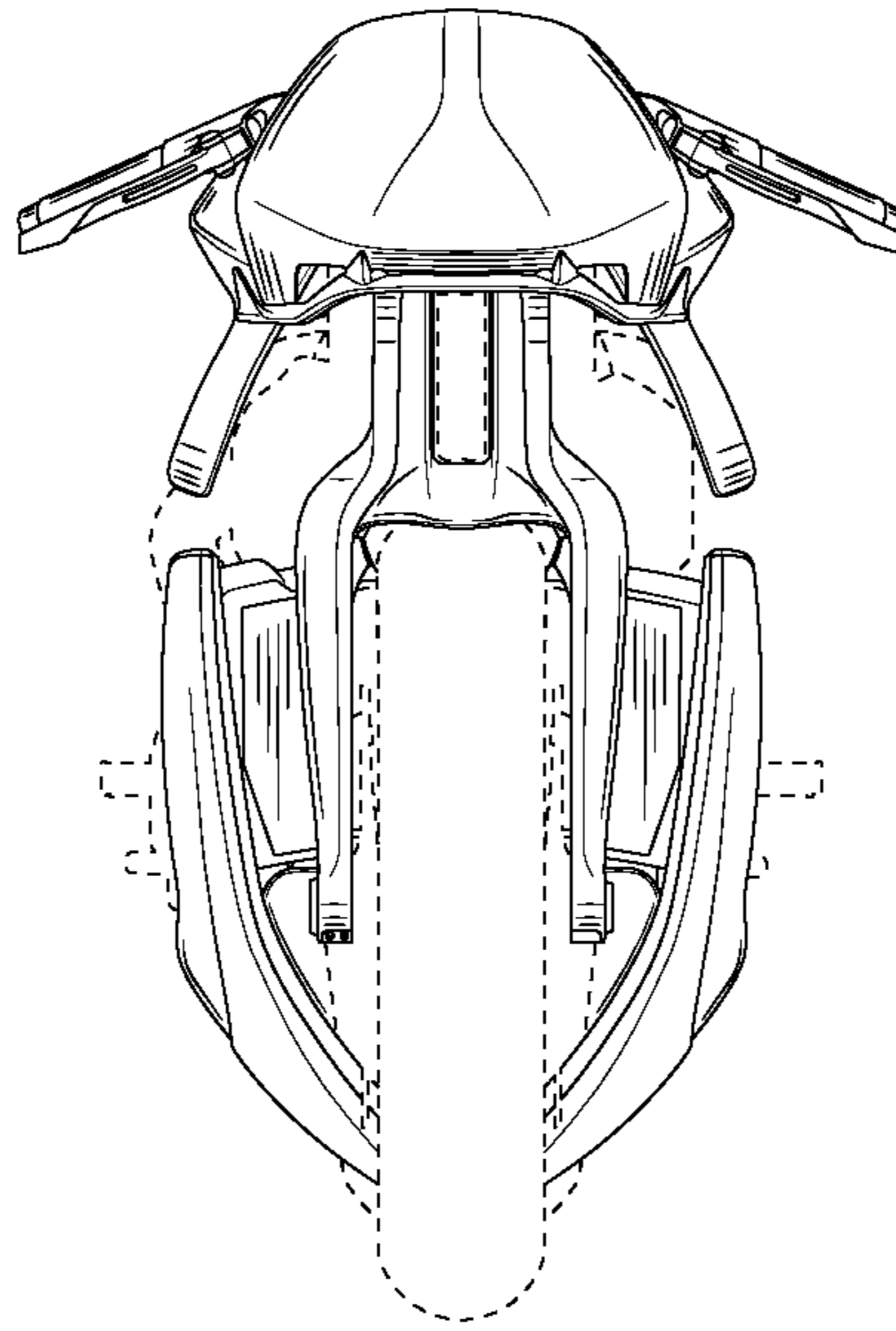

FIG. 3

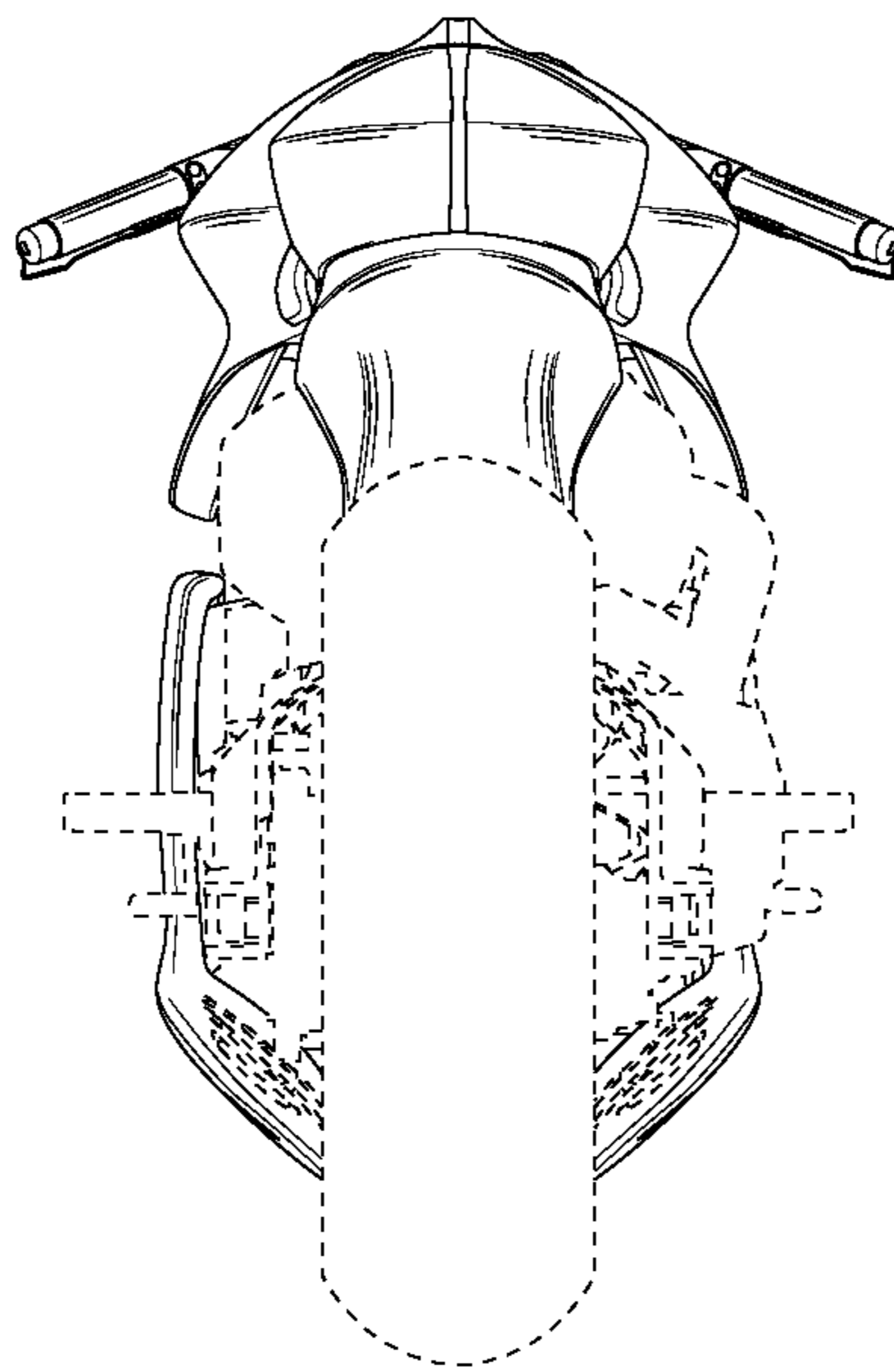

FIG. 4

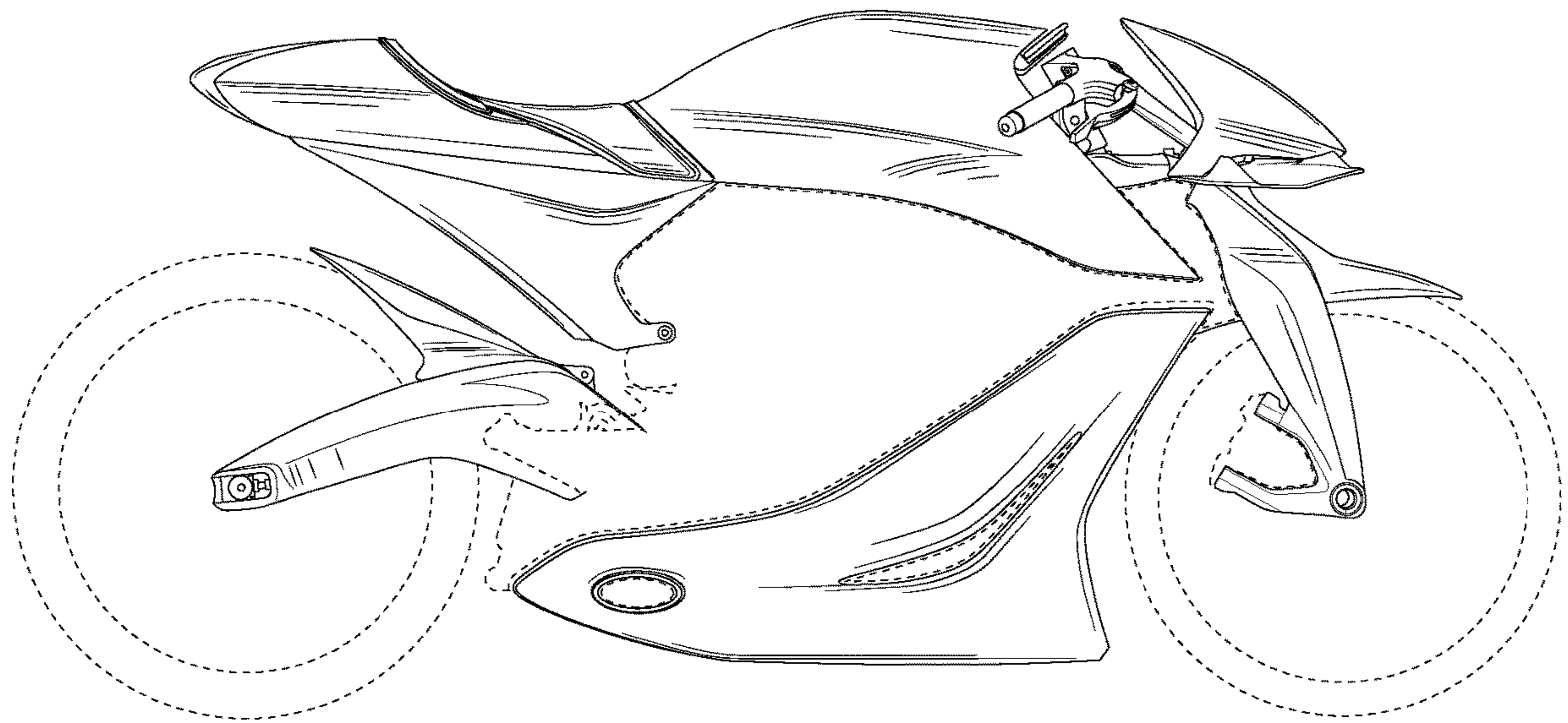

FIG. 5

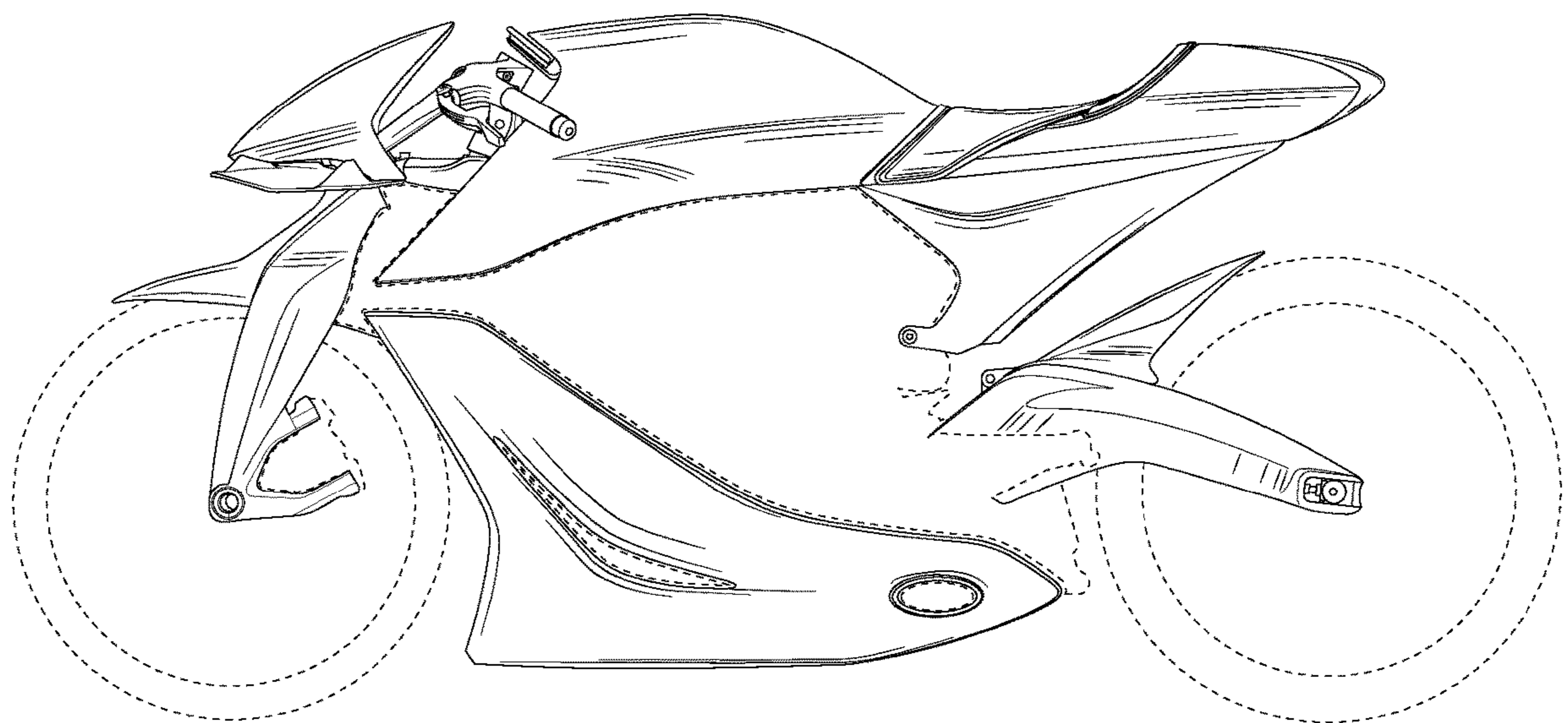

FIG. 6

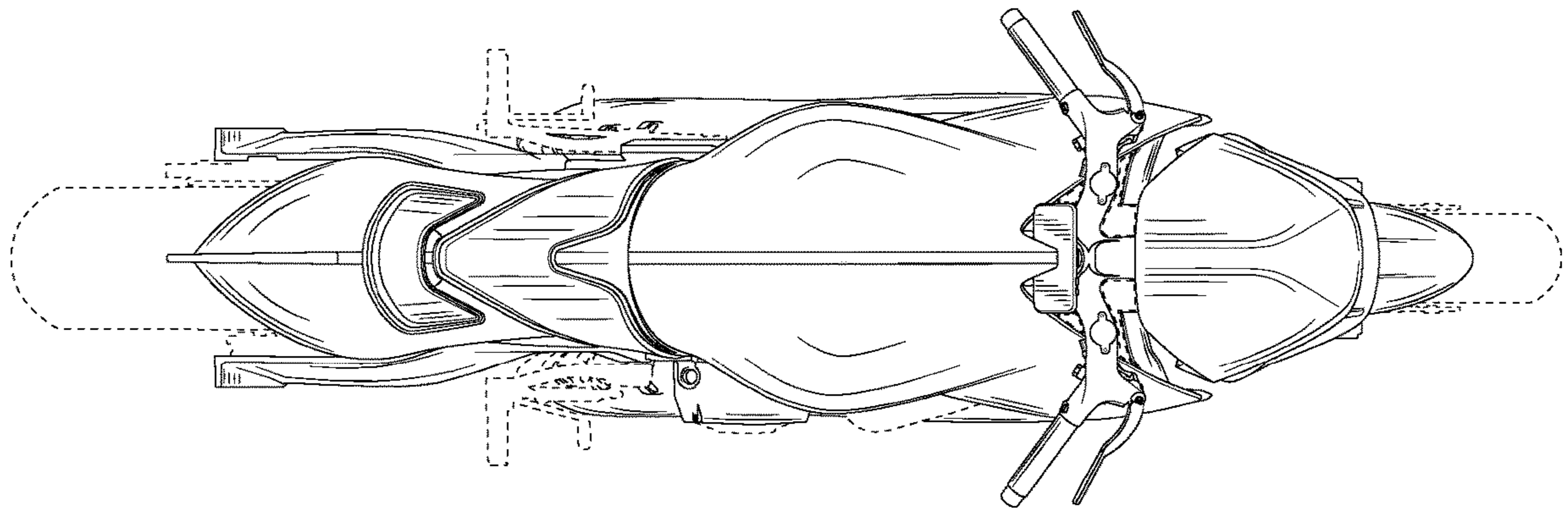

FIG. 7

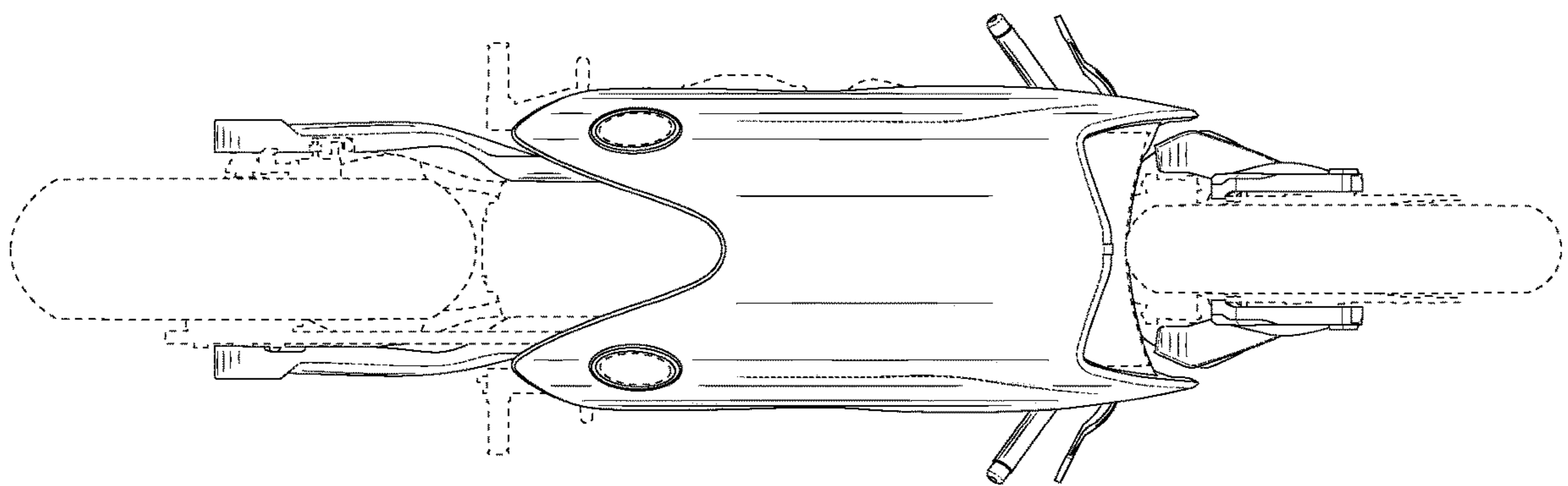

FIG. 8