



US00D976155S

(12) **United States Design Patent**
Li

(10) **Patent No.:** **US D976,155 S**
(45) **Date of Patent:** **** Jan. 24, 2023**

- (54) **STOCKING HOLDER ASSEMBLY**
- (71) Applicant: **Shenzhen Shanggou Technology Co., Ltd.**, Guangdong (CN)
- (72) Inventor: **Boqian Li**, Jiangsu (CN)
- (73) Assignee: **Shenzhen Shanggou Technology Co., Ltd.**, Shenzhen (CN)
- (**) Term: **15 Years**
- (21) Appl. No.: **29/857,939**
- (22) Filed: **Oct. 26, 2022**
- (51) **LOC (14) Cl.** **11-05**
- (52) **U.S. Cl.**
USPC **D11/130**
- (58) **Field of Classification Search**
USPC D11/115, 130; D6/320, 323, 672, 678, D6/682
CPC A47G 33/00; A47G 33/10; B44C 5/02; B44C 5/04; B44C 7/00
See application file for complete search history.

- (56) **References Cited**
U.S. PATENT DOCUMENTS
2,734,993 A * 2/1956 Fritz A47G 33/1206 362/124
D284,716 S * 7/1986 Honermann D6/315

- D319,903 S 9/1991 Barner
- D389,089 S * 1/1998 Lal D12/9
- D407,165 S * 3/1999 Muto D26/14
- D435,327 S * 12/2000 Schallip D1/110
- D483,976 S * 12/2003 Hoernig D6/574
- D628,119 S * 11/2010 Sandberg D11/121
- D635,846 S * 4/2011 Klein D8/372
- D682,149 S * 5/2013 Dubow D11/157
- D690,225 S * 9/2013 DuBow D11/157
- D858,154 S * 9/2019 Bourgoyne D6/682

* cited by examiner

Primary Examiner — Kelley A Donnelly

(57) **CLAIM**

The ornamental design for a stocking holder assembly, as shown and described.

DESCRIPTION

FIG. 1 is a top and front side perspective view of a stocking holder assembly, showing my new design; FIG. 2 is a front elevational view thereof; FIG. 3 is a back elevational view thereof; FIG. 4 is a left side elevational view thereof; FIG. 5 is a right side elevational view thereof; FIG. 6 is a top plan view thereof; and, FIG. 7 is a bottom plan view thereof.

1 Claim, 7 Drawing Sheets

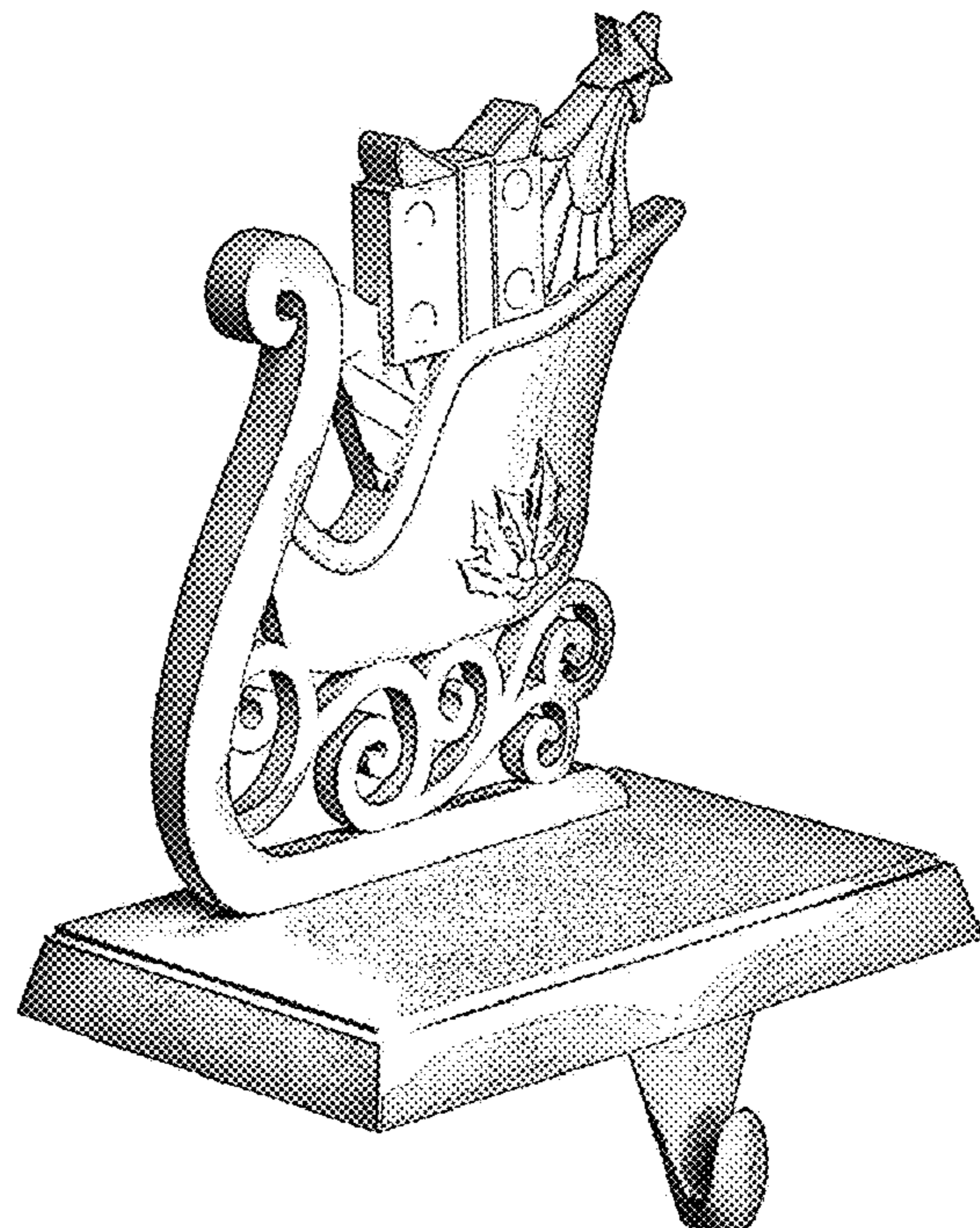
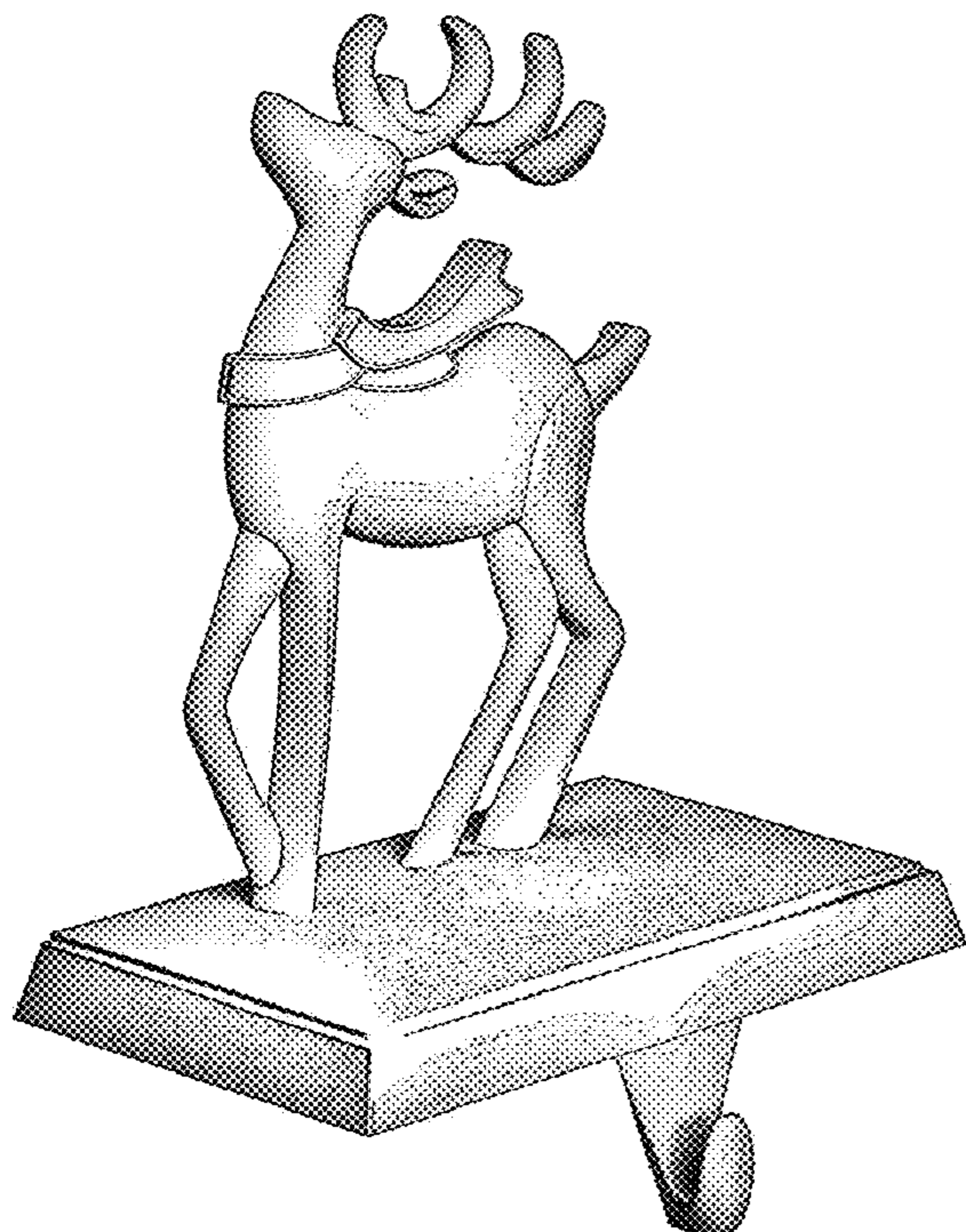

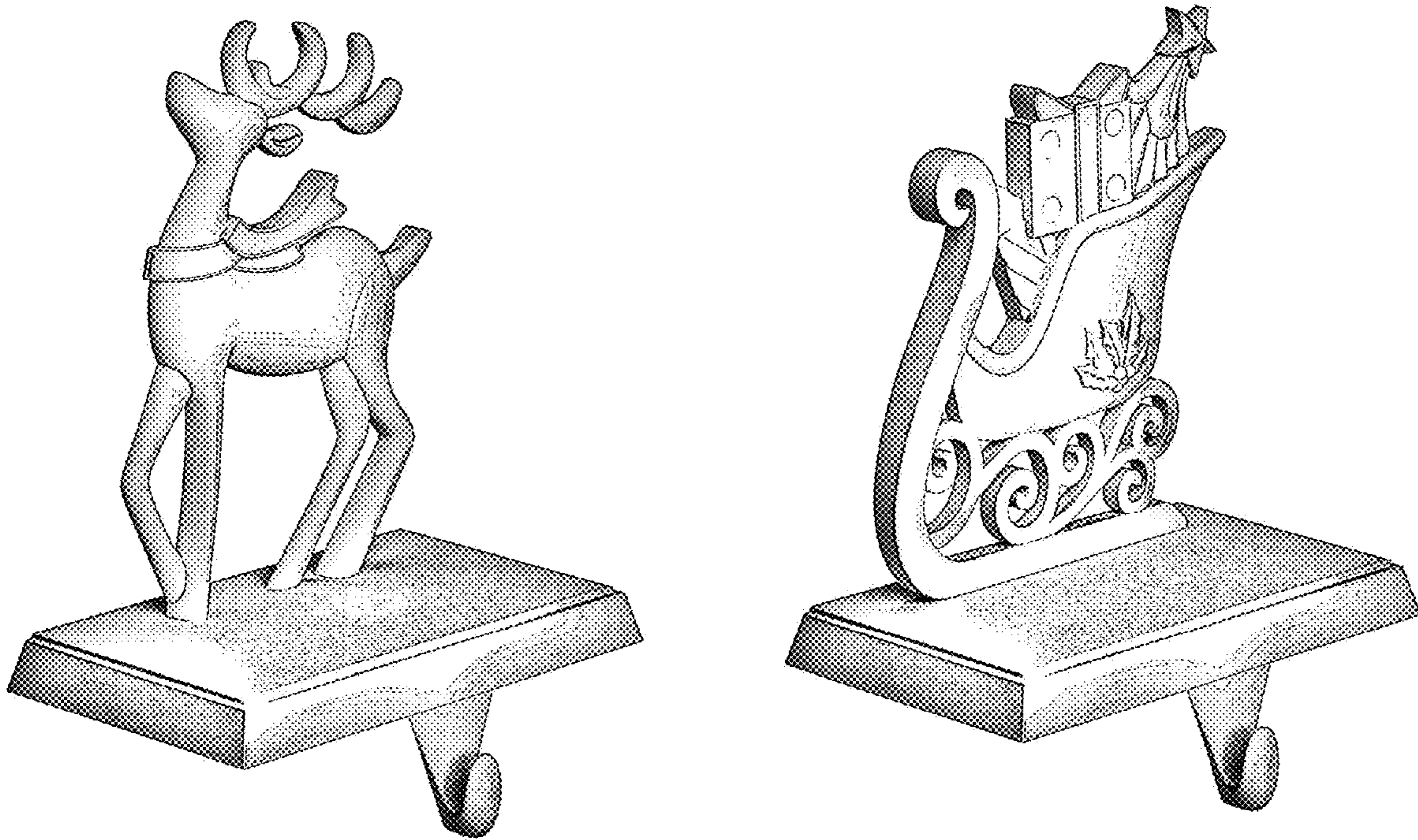

FIG. 1

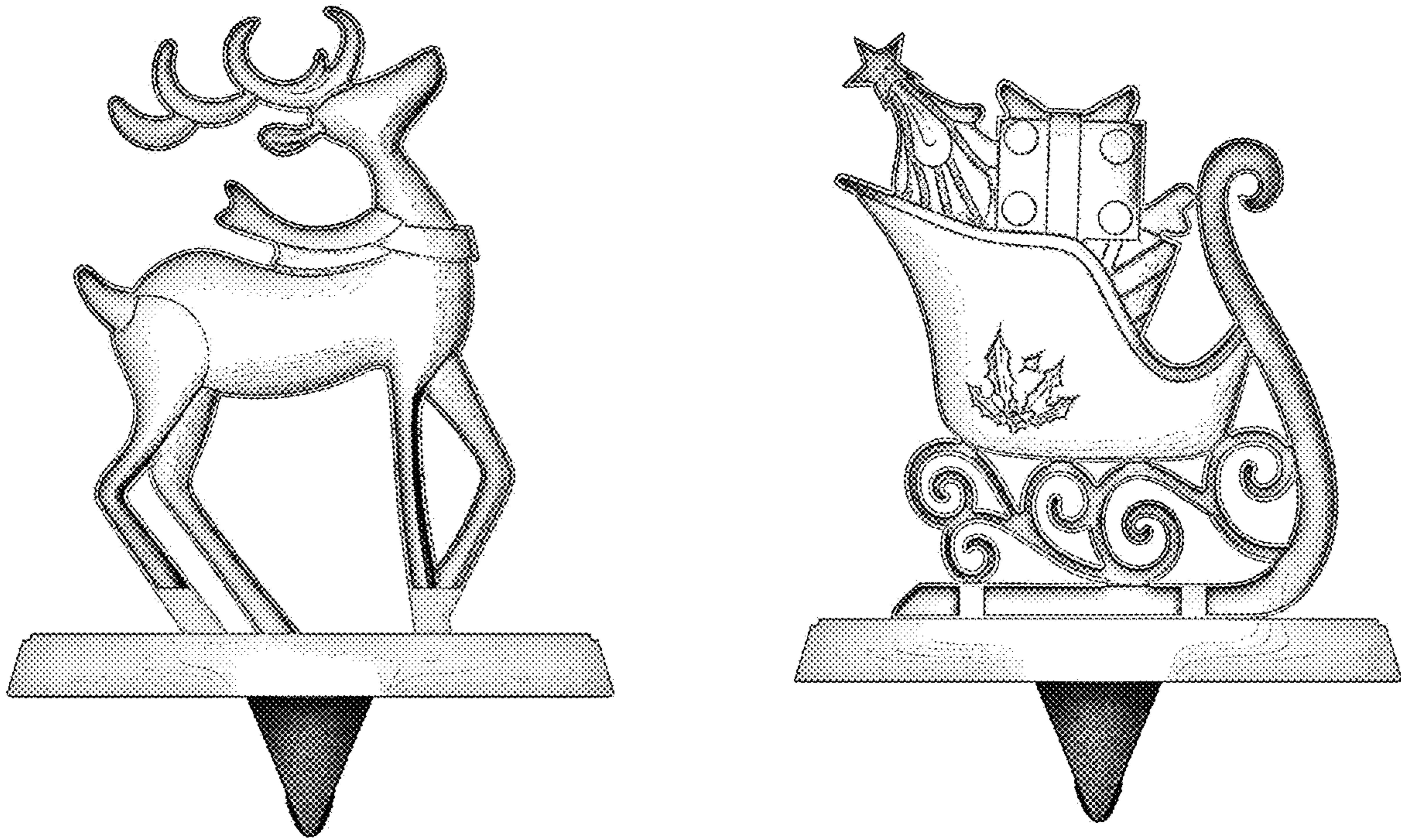

FIG. 2

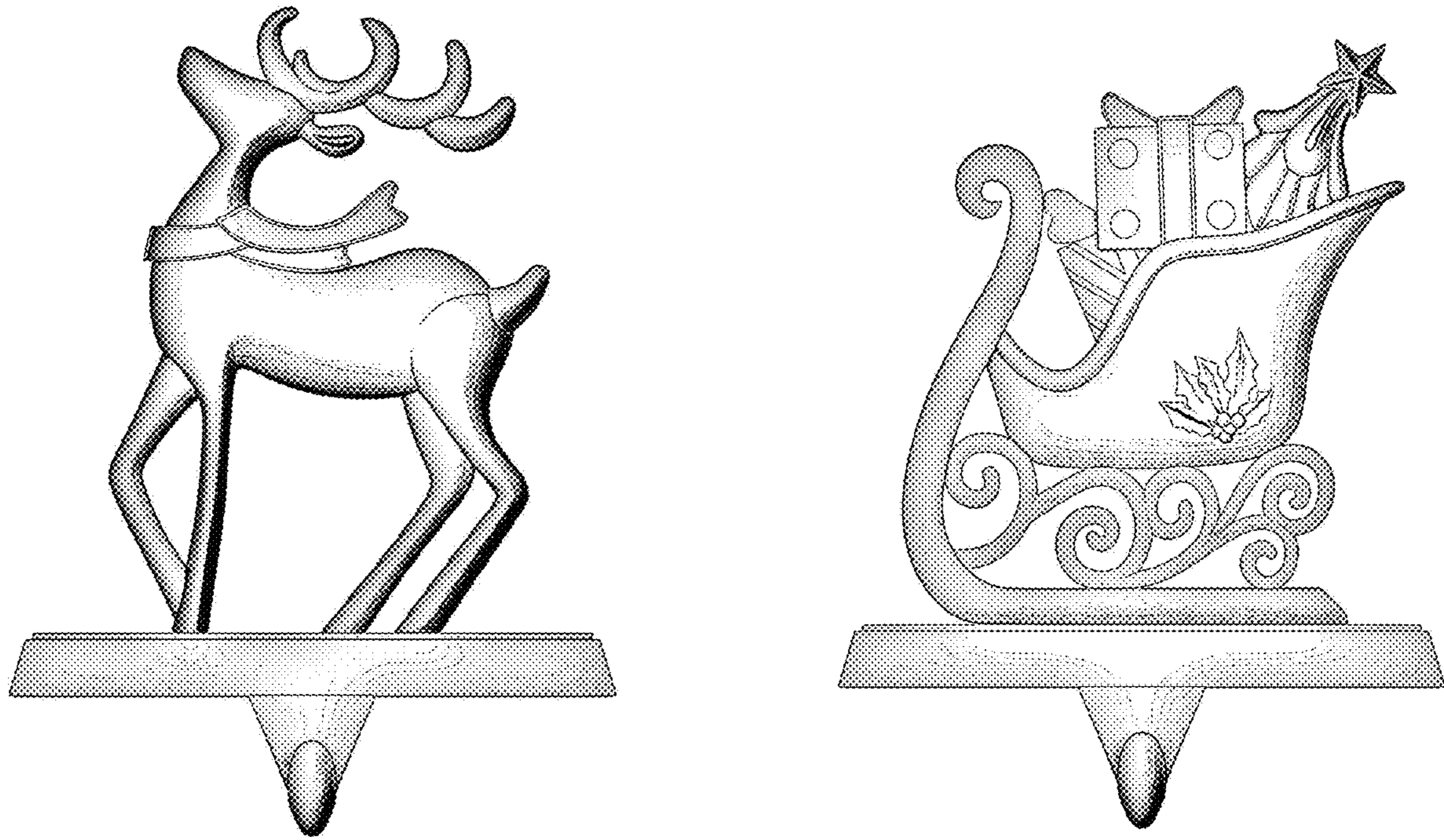

FIG. 3

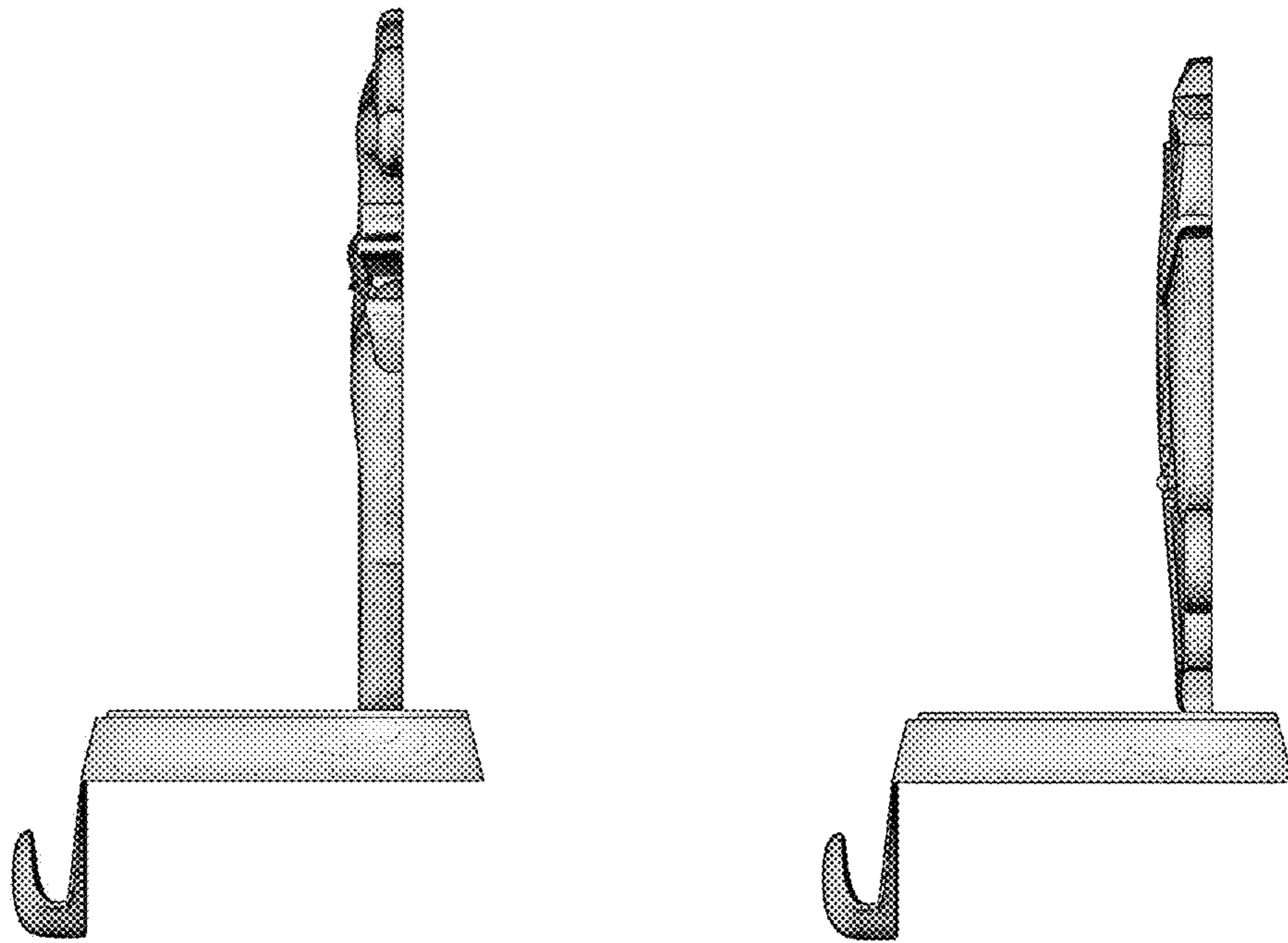

FIG. 4

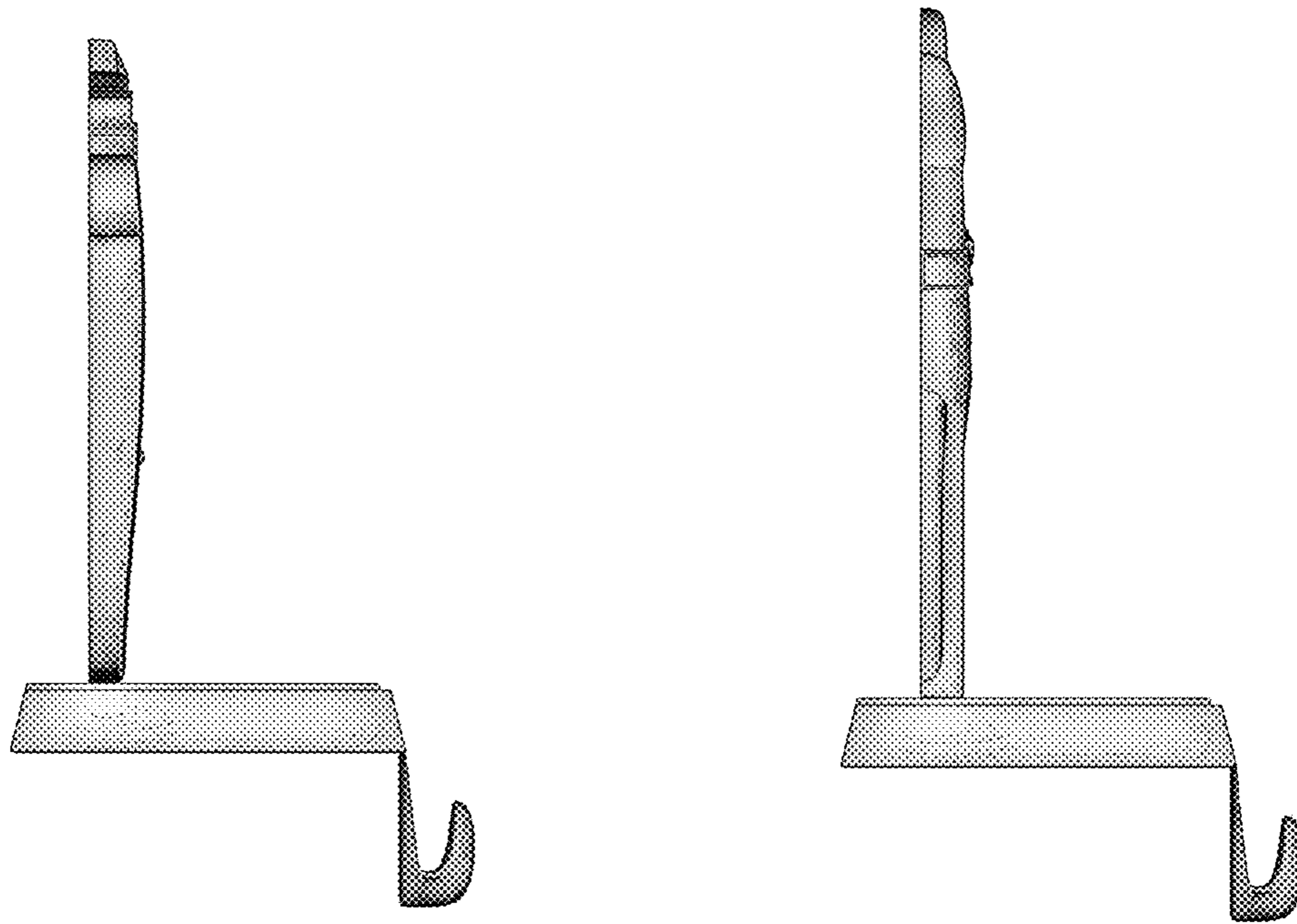

FIG. 5

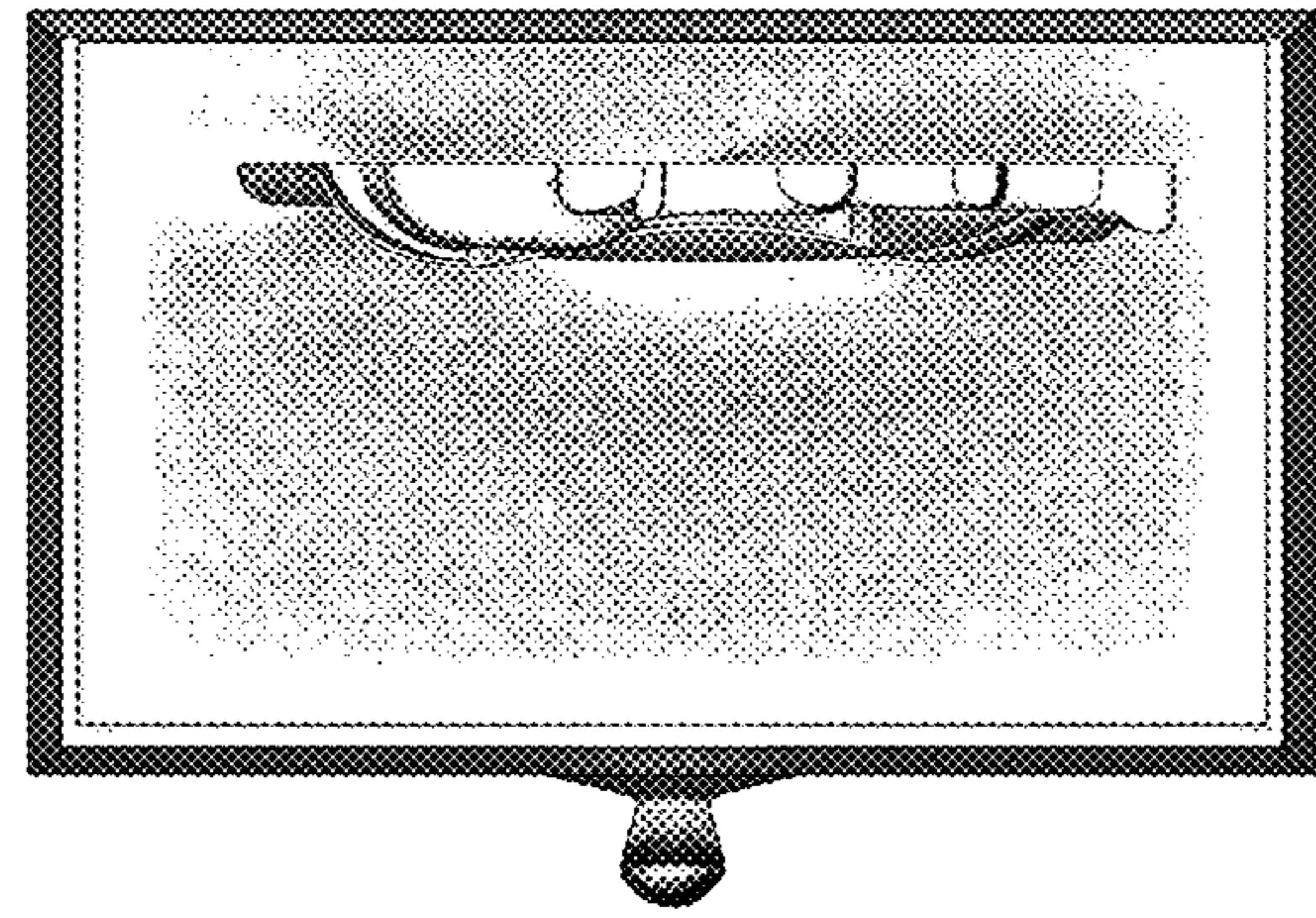
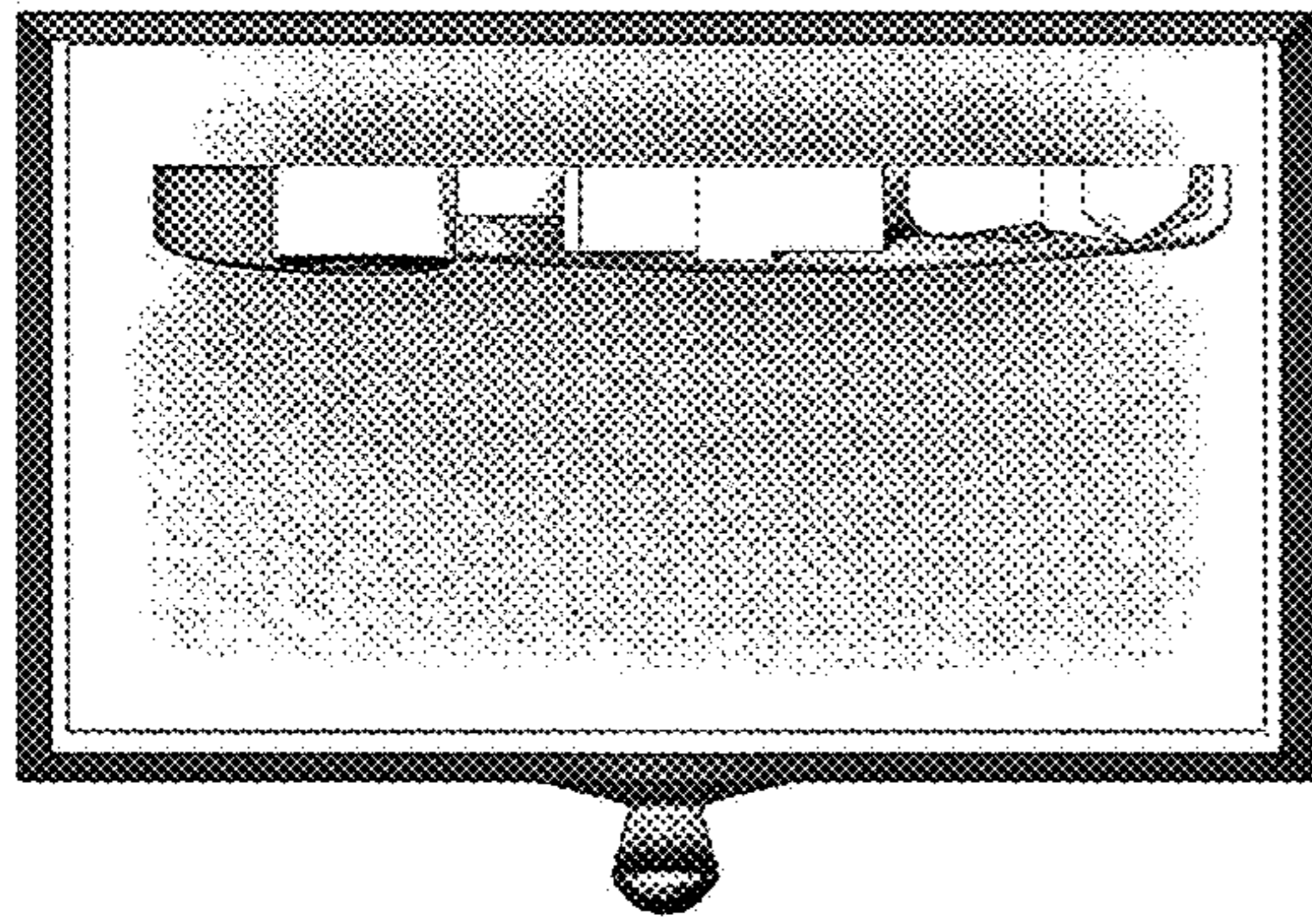

FIG. 6

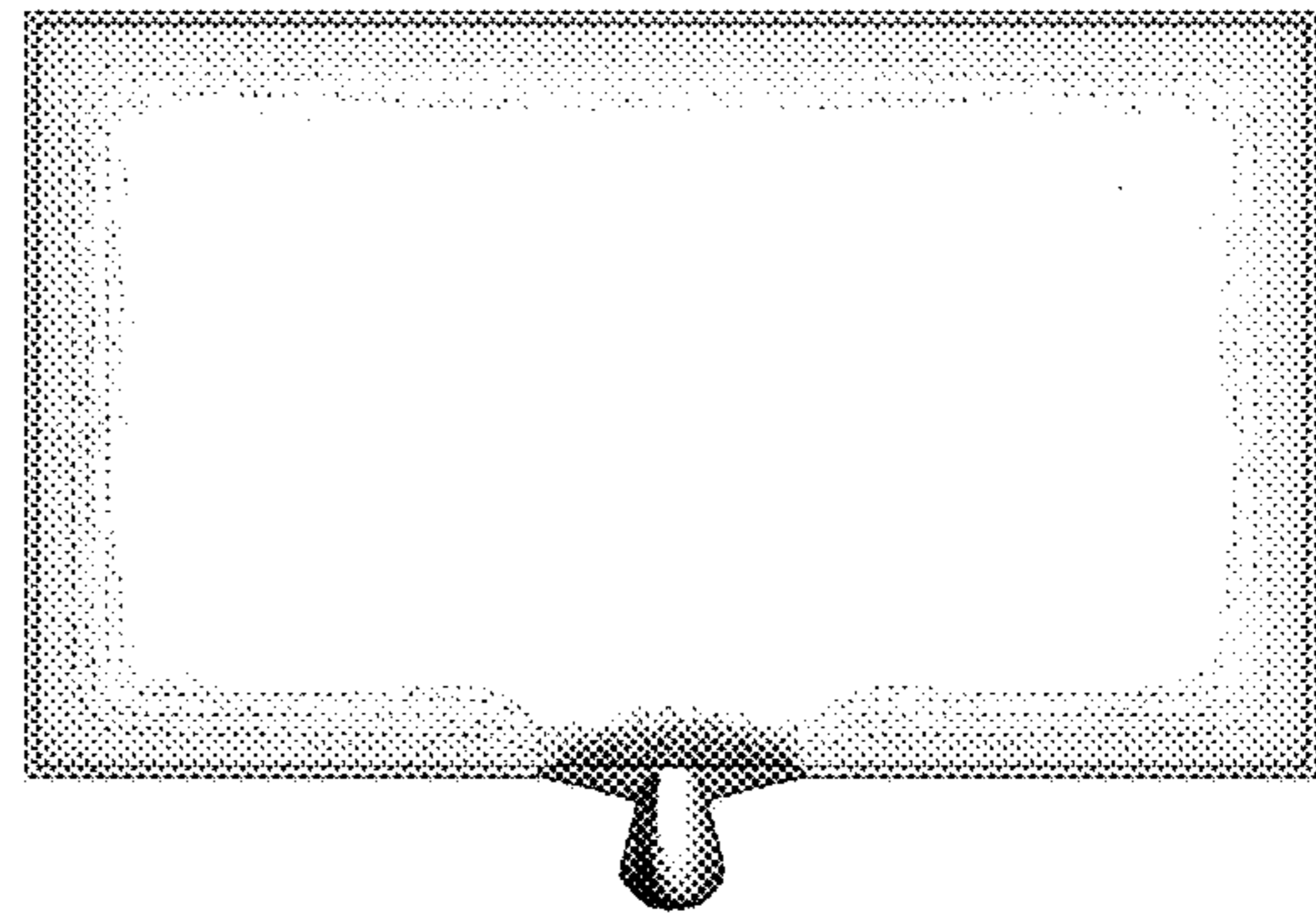
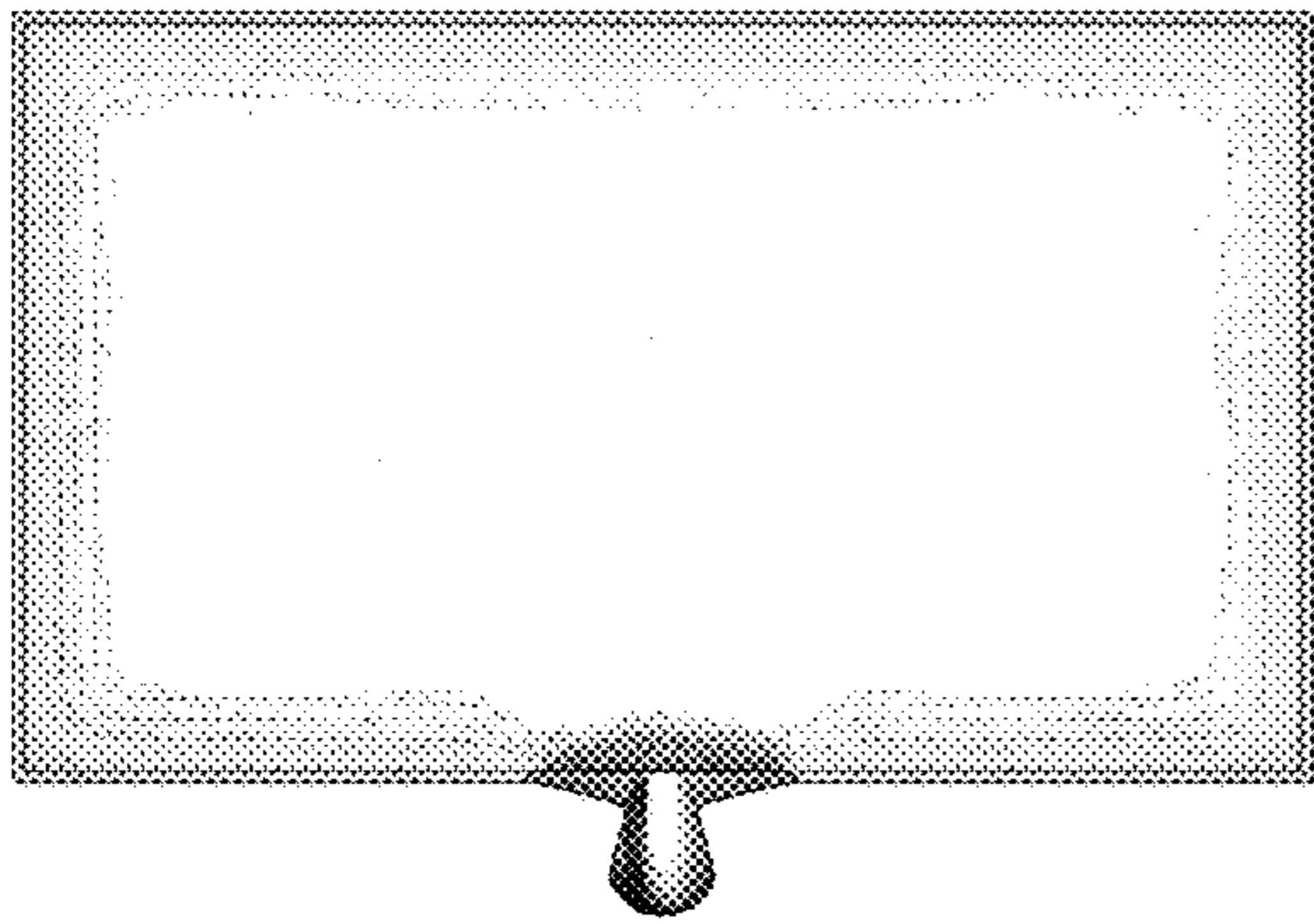

FIG. 7