



US00D976114S

(12) **United States Design Patent** (10) **Patent No.:** **US D976,114 S**
Foley et al. (45) **Date of Patent:** **** Jan. 24, 2023**

(54) **PACKAGING FOR FACIAL WIPES**

Primary Examiner — Lauren R Calve

(71) Applicant: **Johnson & Johnson Consumer Inc.,**
Skillman, NJ (US)

(57) **CLAIM**

(72) Inventors: **Sarah A. Foley,** Brooklyn, NY (US);
Elizabeth Cansfield, Milford, NJ (US)

The ornamental design for a packaging for facial wipes, as shown and described.

(73) Assignee: **Johnson & Johnson Consumer Inc.,**
Skillman, NJ (US)

DESCRIPTION

(**) Term: **15 Years**

(21) Appl. No.: **29/785,768**

(22) Filed: **May 27, 2021**

(51) **LOC (14) Cl.** **09-01**

(52) **U.S. Cl.**
USPC **D9/600; D9/734; D9/433**

(58) **Field of Classification Search**
USPC D9/414, 432, 433, 600, 734
CPC ... B65D 2203/00; B65D 5/425; B65D 51/245
See application file for complete search history.

FIG. 1 is a perspective view of a packaging for facial wipes; FIG. 2 is a top view of the packaging of FIG. 1; FIG. 3 is a bottom view of the packaging of FIG. 1; FIG. 4 is a side elevation view of the packaging of FIG. 1; FIG. 5 is a second side elevation view of the packaging of FIG. 1; FIG. 6 is a third side elevation view of the packaging of FIG. 1; FIG. 7 is a fourth side elevation view of the packaging of FIG. 1; FIG. 8 is a top view of the packaging of FIG. 1 in an unsealed configuration. FIG. 9 is a perspective view of another embodiment of a packaging for facial wipes; FIG. 10 is a top view of the packaging of FIG. 9; FIG. 11 is a bottom view of the packaging of FIG. 9; FIG. 12 is a side elevation view of the packaging of FIG. 9; FIG. 13 is a second side elevation view of the packaging of FIG. 9; FIG. 14 is a third side elevation view of the packaging of FIG. 9; FIG. 15 is a fourth side elevation view of the packaging of FIG. 9; and, FIG. 16 is a top view of the packaging of FIG. 9 in an unsealed configuration. The broken lines are included for the purpose of illustrating unclaimed portions of the packaging for facial wipes and form no part of the claimed design.

(56) **References Cited**

U.S. PATENT DOCUMENTS

D171,298	S	*	1/1954	Del Mas	D9/674
3,024,958	A	*	3/1962	Loderhose	B65D 5/422
						229/242
D343,572	S	*	1/1994	Billelo	D9/649
5,294,040	A	*	3/1994	Cohen	B65D 5/241
						229/116.1
D349,051	S	*	7/1994	Brown, Jr.	D9/433
D499,960	S	*	12/2004	Duboeuf	D9/638
D655,186	S	*	3/2012	Boyer	D9/600
D868,595	S	*	12/2019	Zenkich	D9/600
D868,596	S	*	12/2019	Zenkich	D9/600
D933,473	S	*	10/2021	Riffe	D9/434
D962,058	S	*	8/2022	Fretwell	D9/434

* cited by examiner

1 Claim, 16 Drawing Sheets

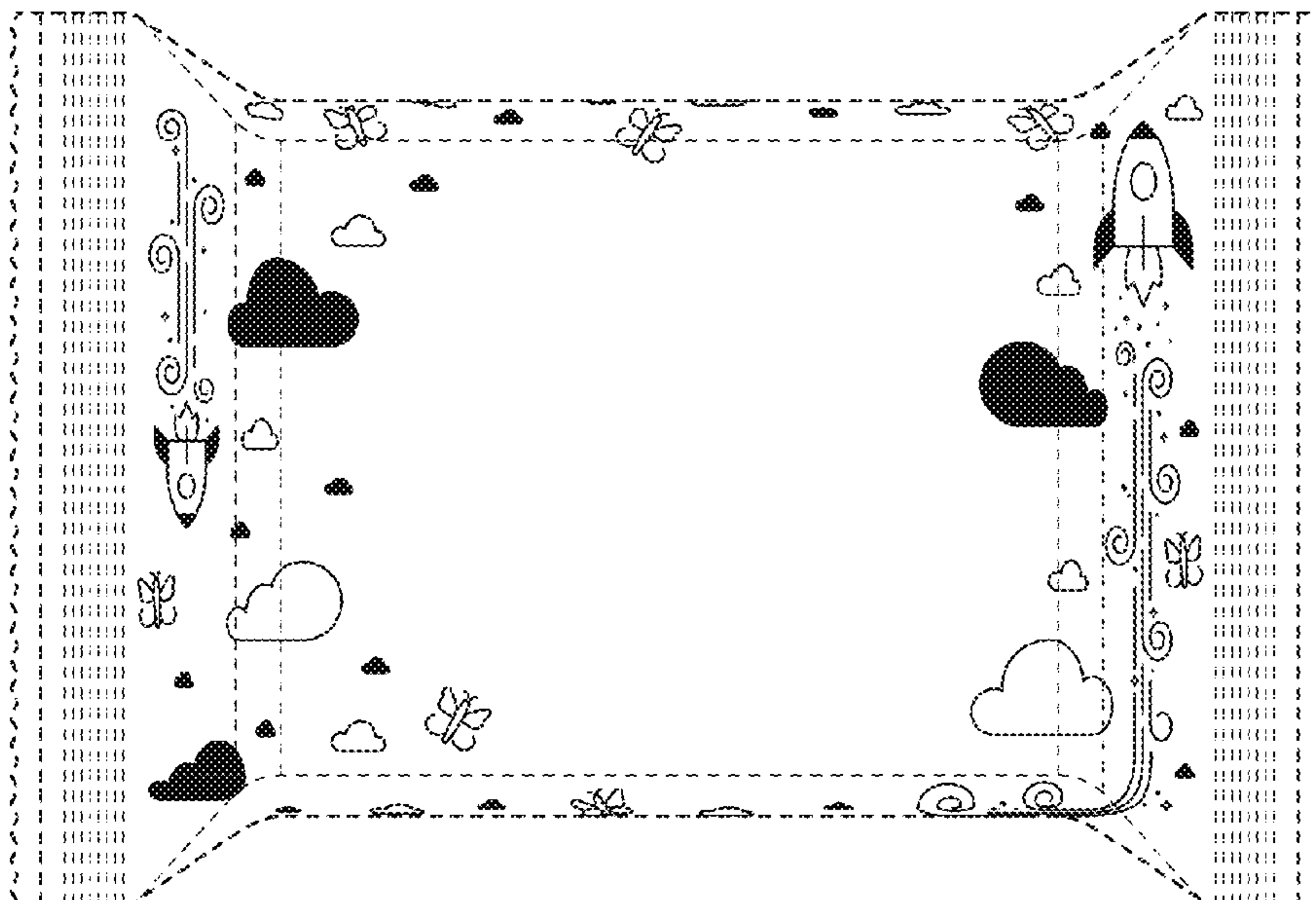

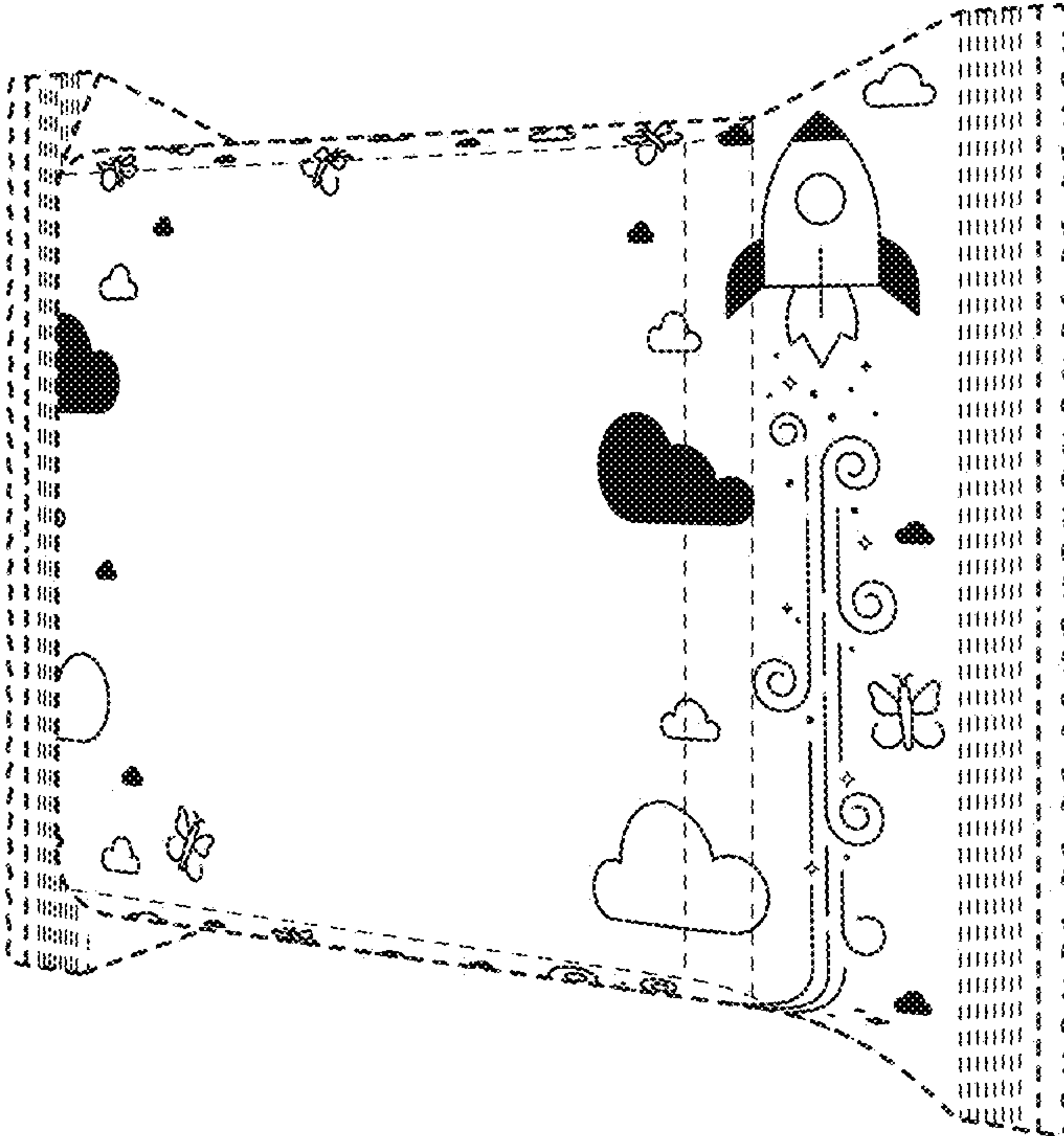

FIG. 1

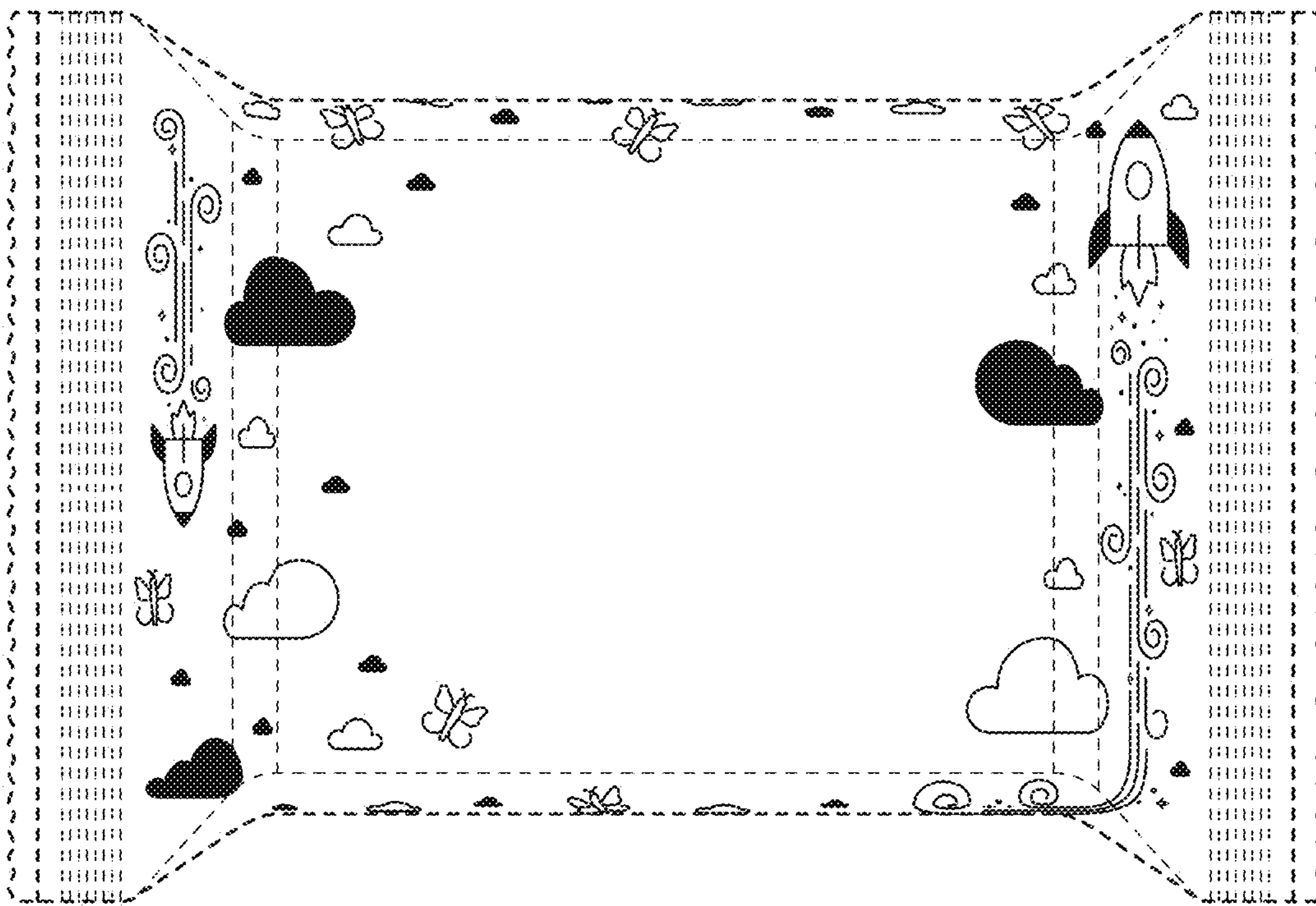

FIG. 2

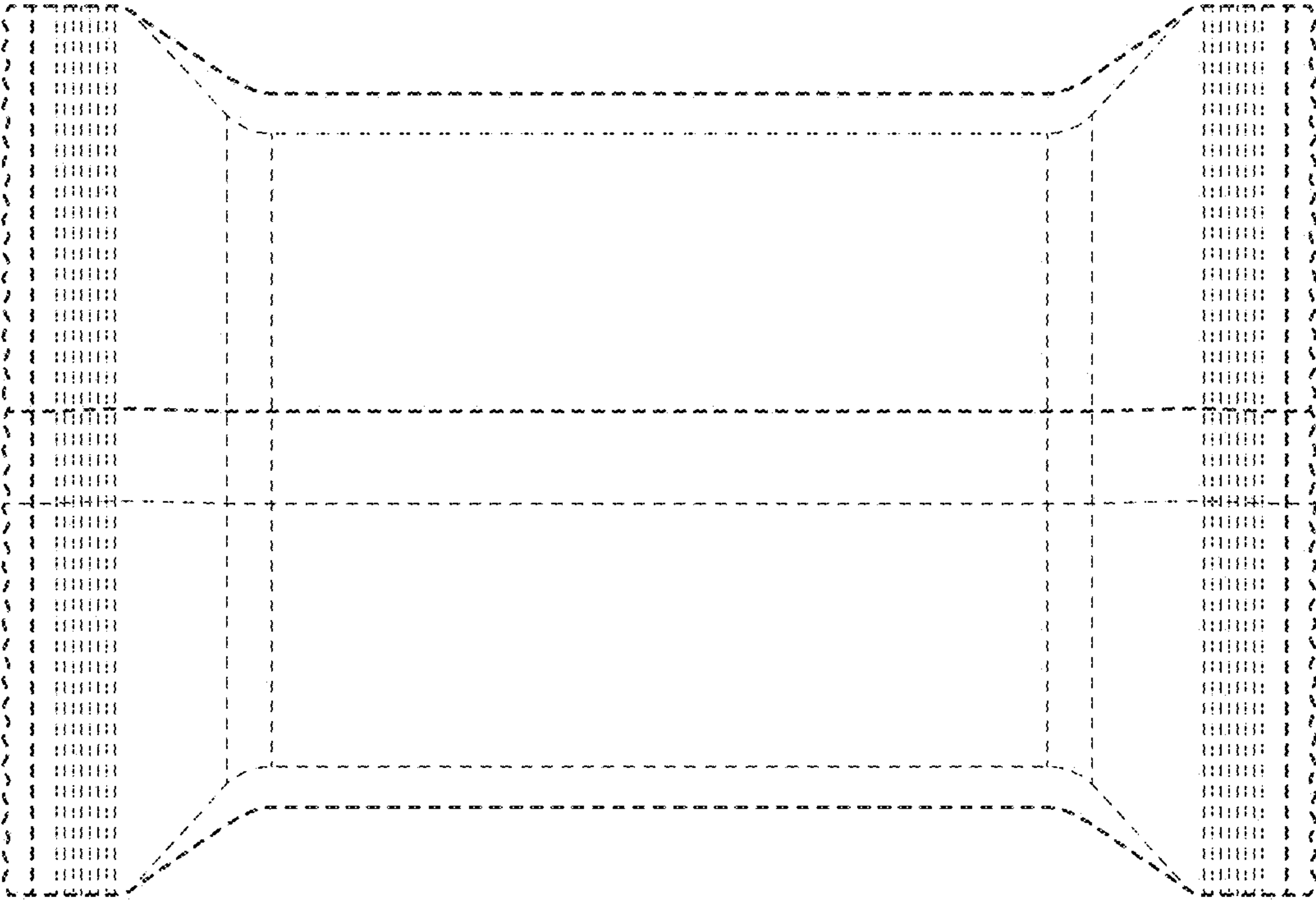

FIG. 3

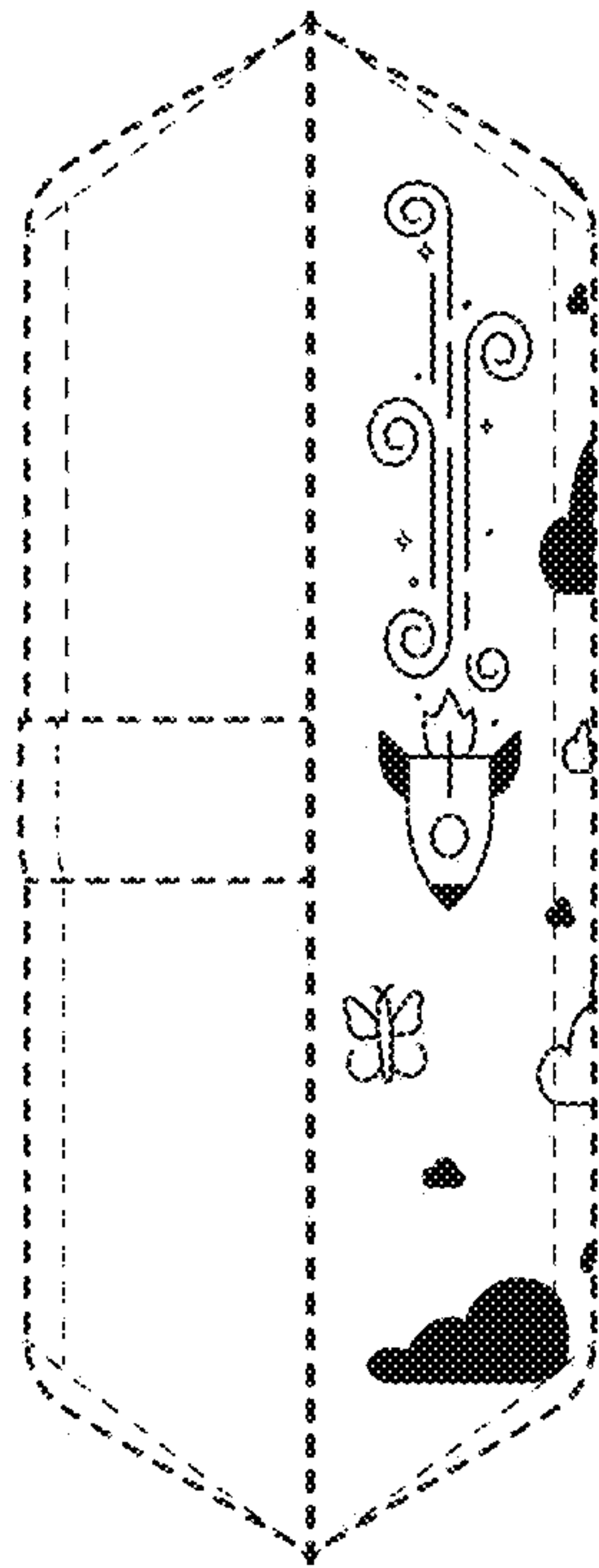

FIG. 4

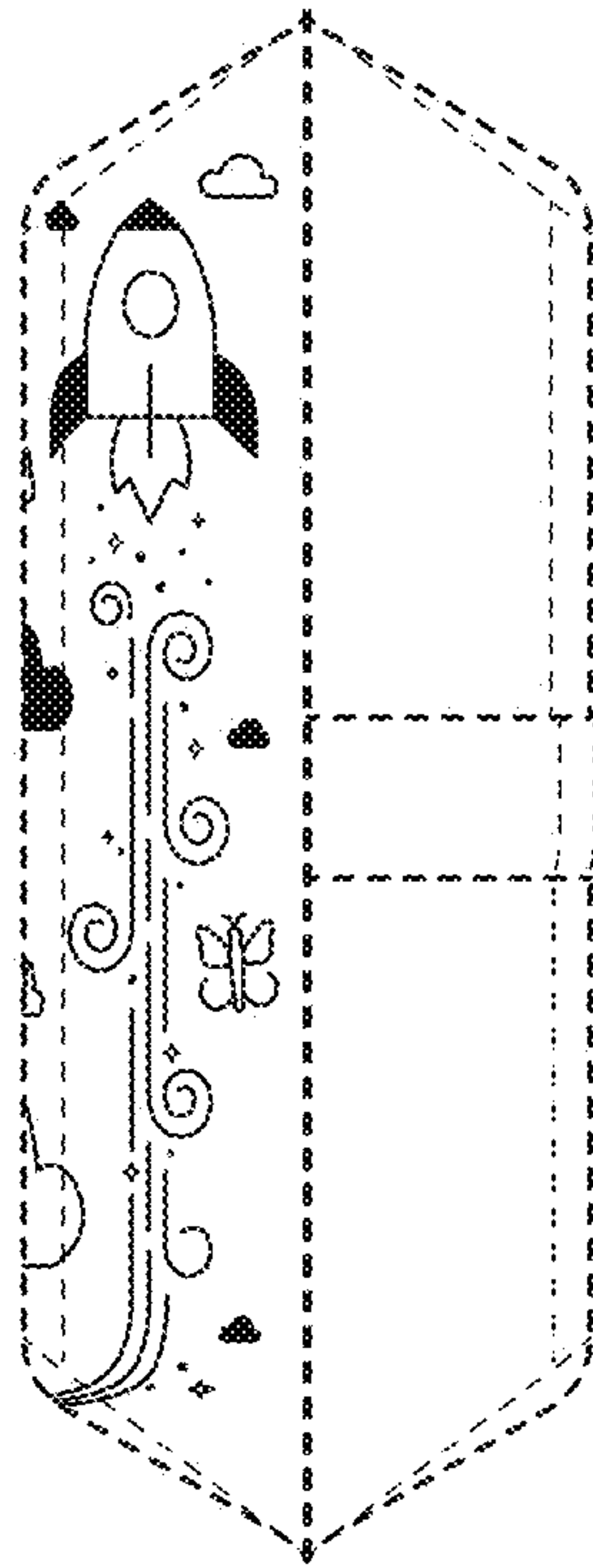

FIG. 5

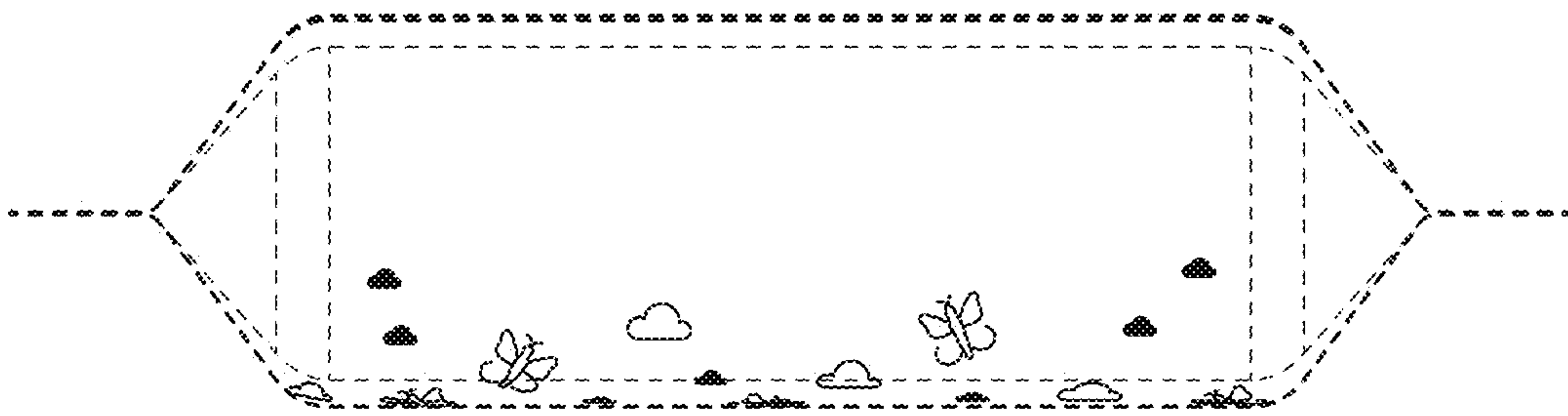

FIG. 6

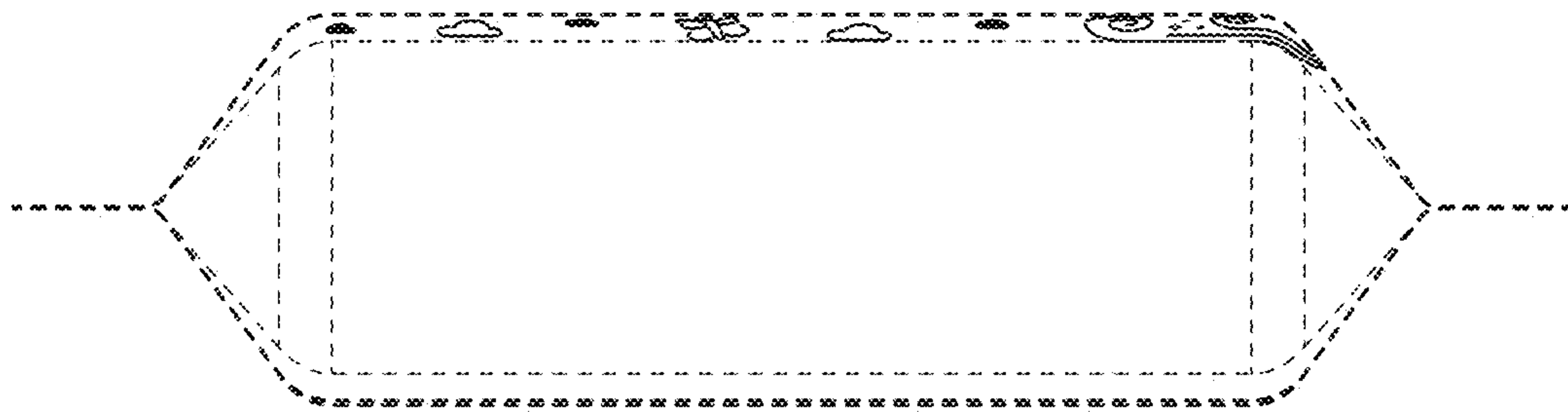

FIG. 7

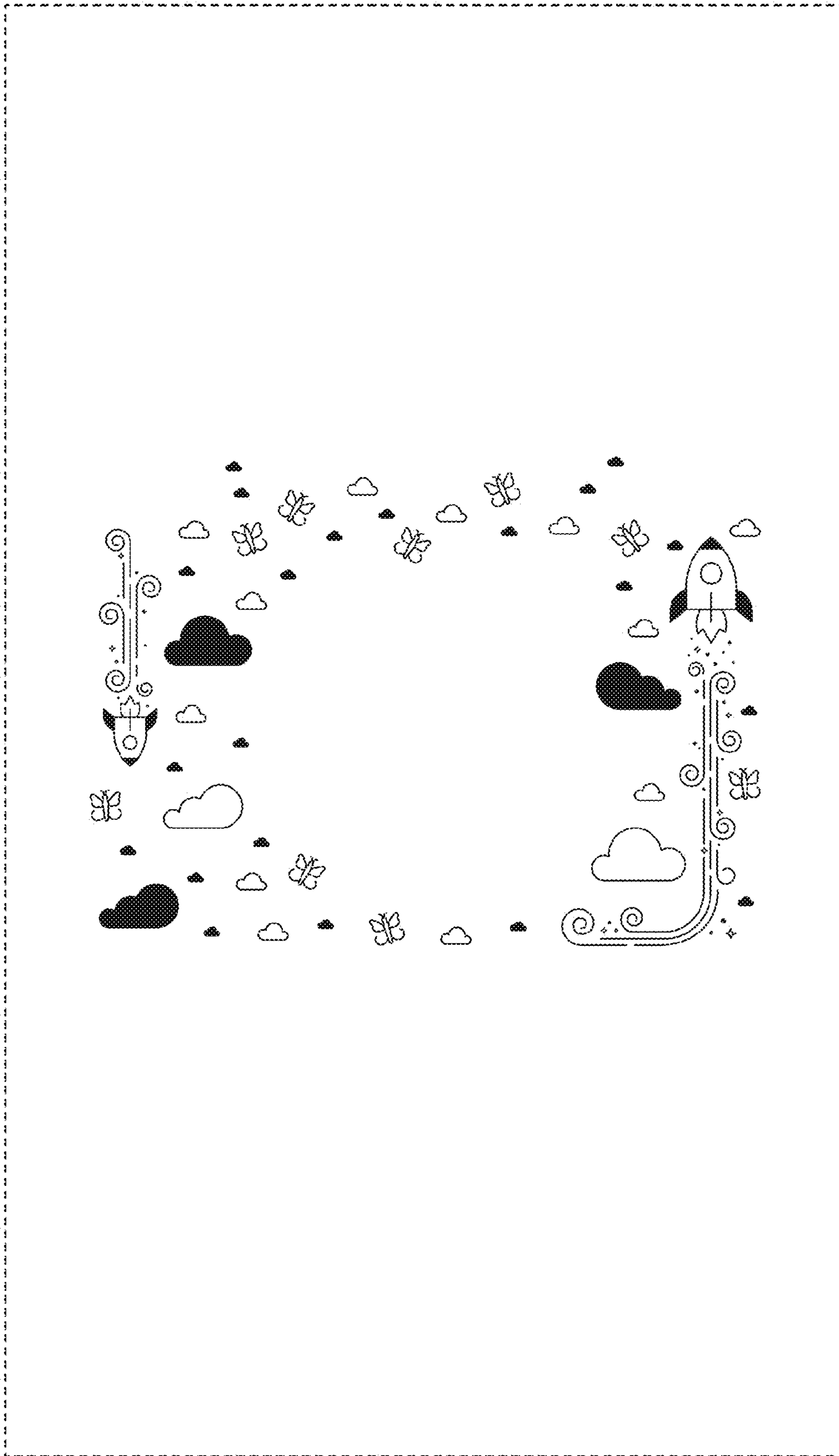

FIG. 8

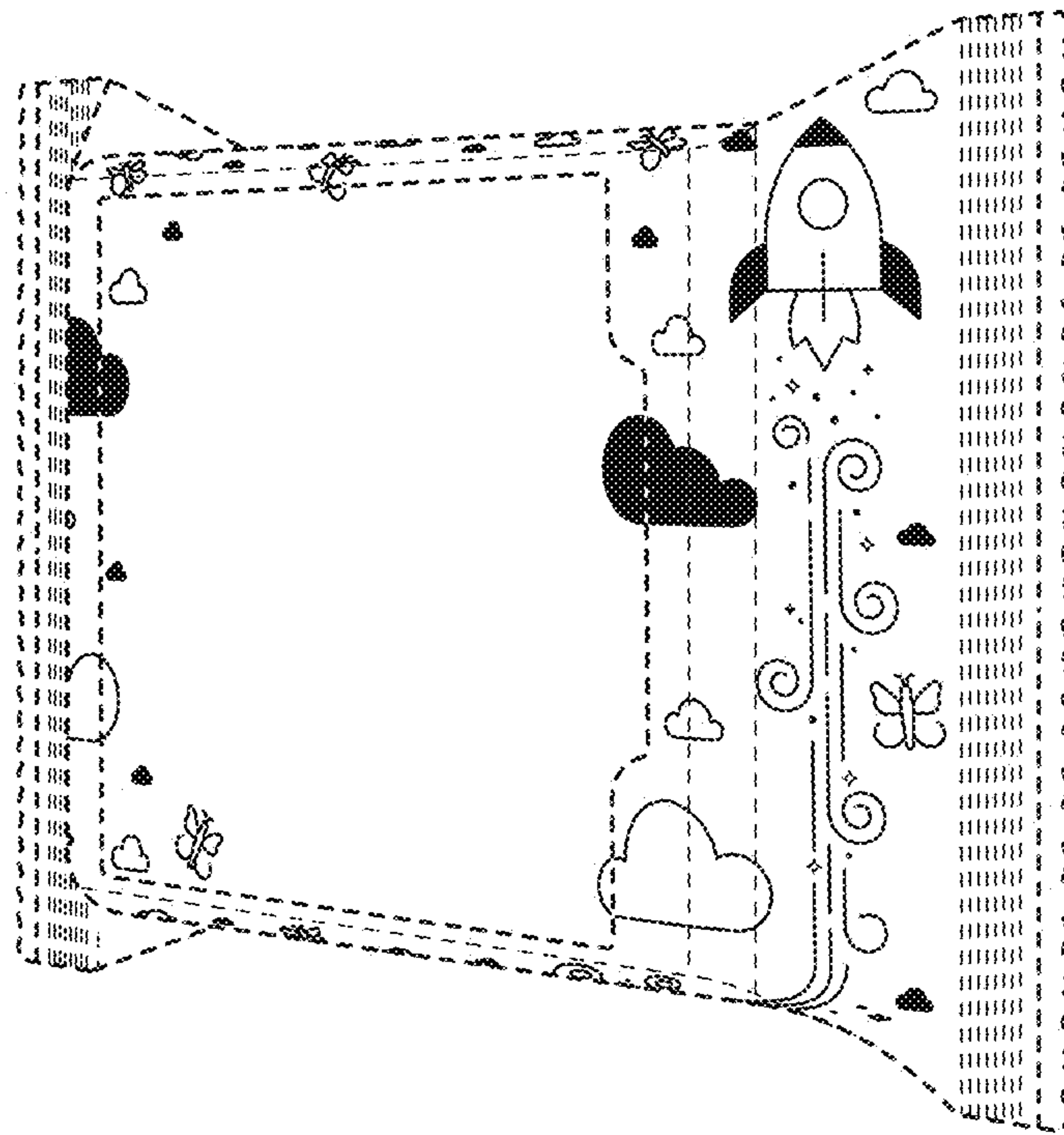

FIG. 9

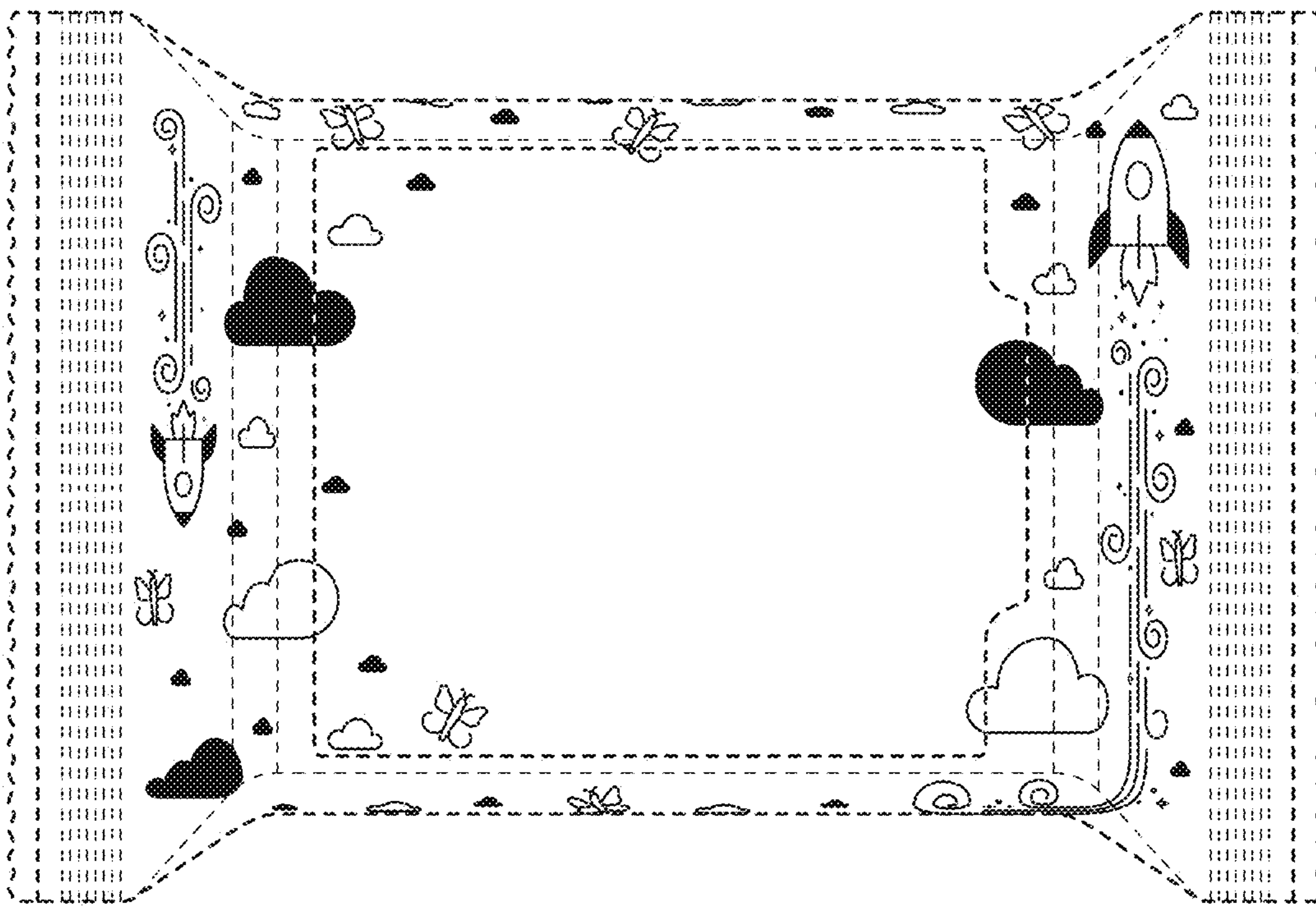

FIG. 10

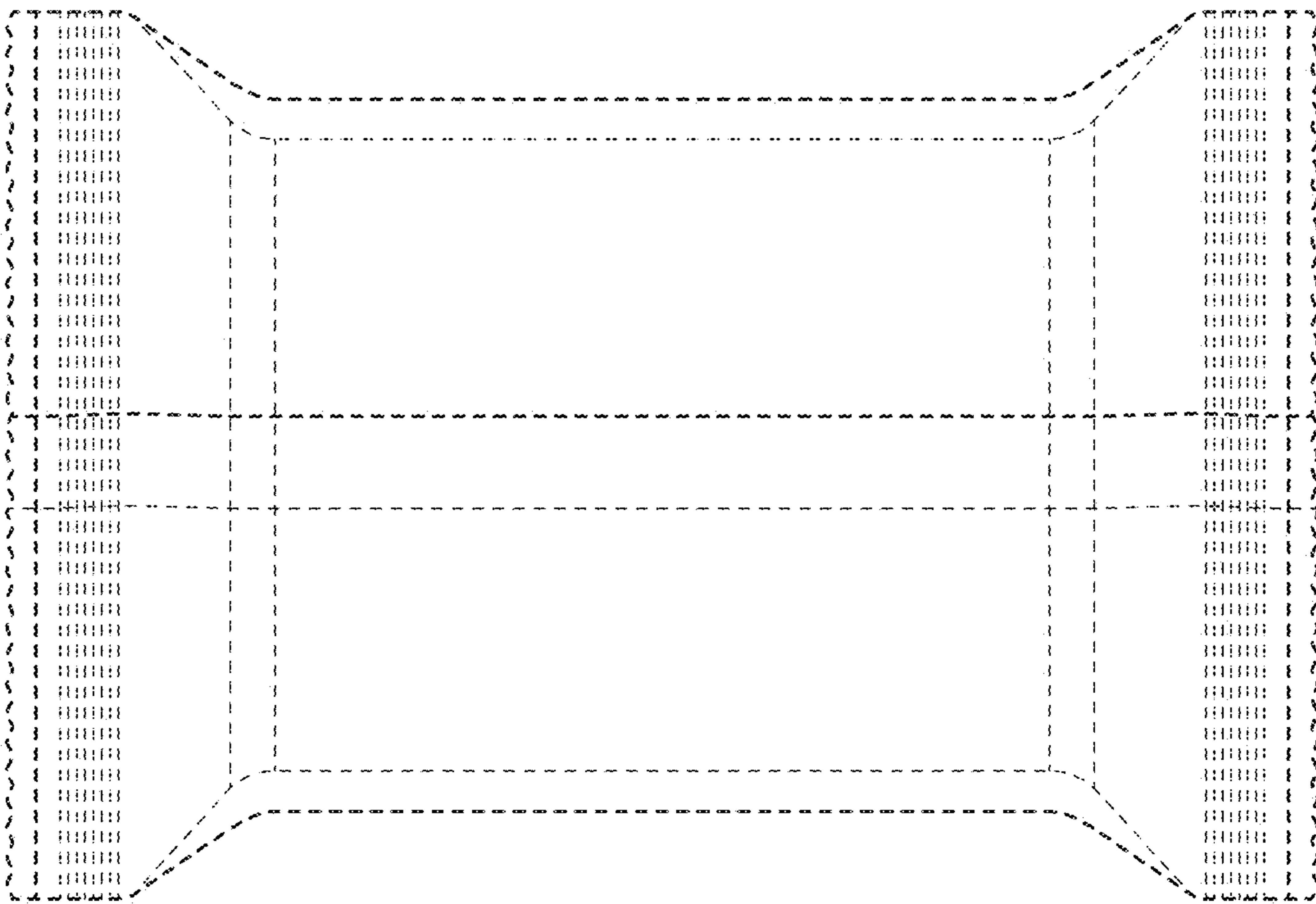

FIG. 11

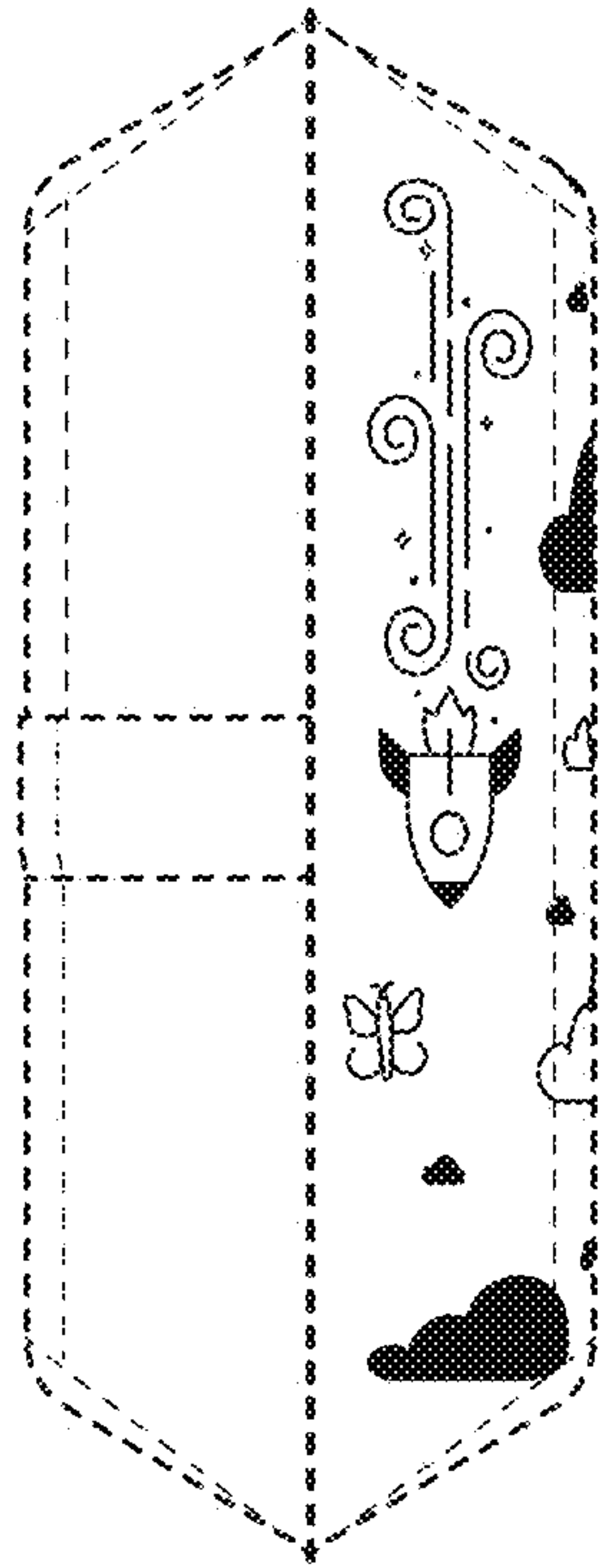

FIG. 12

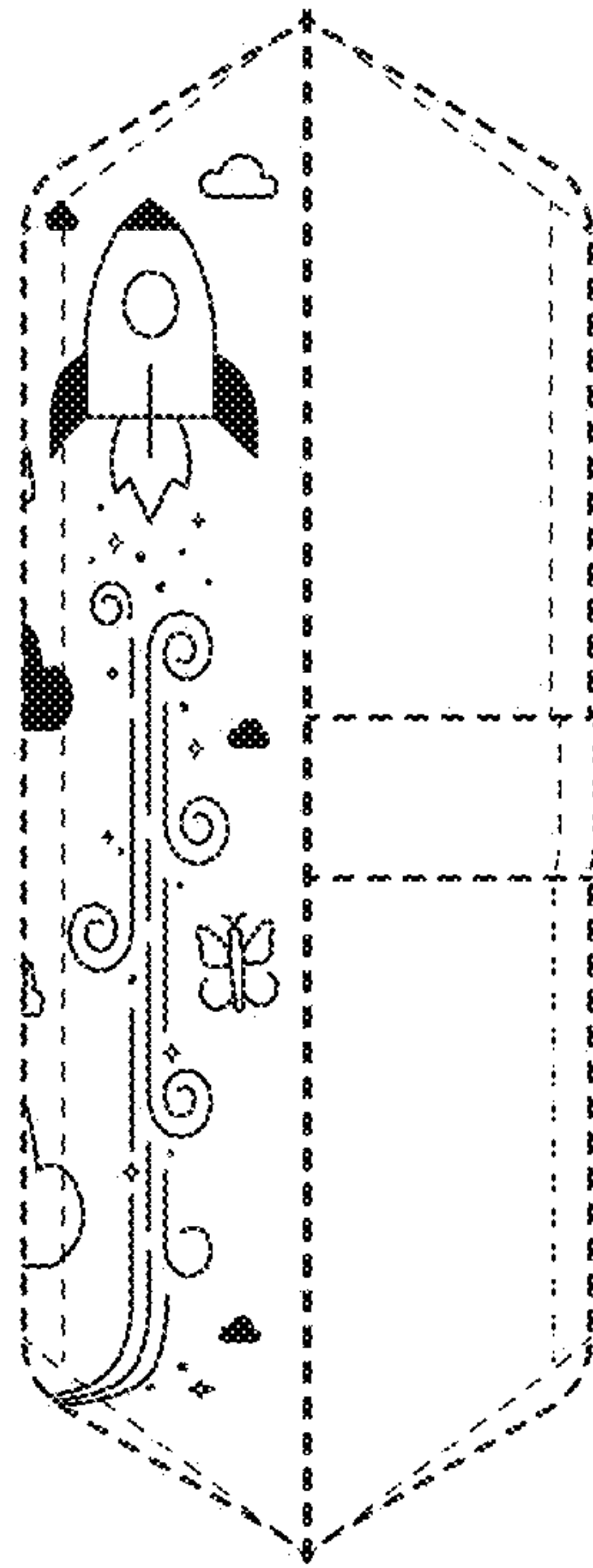

FIG. 13

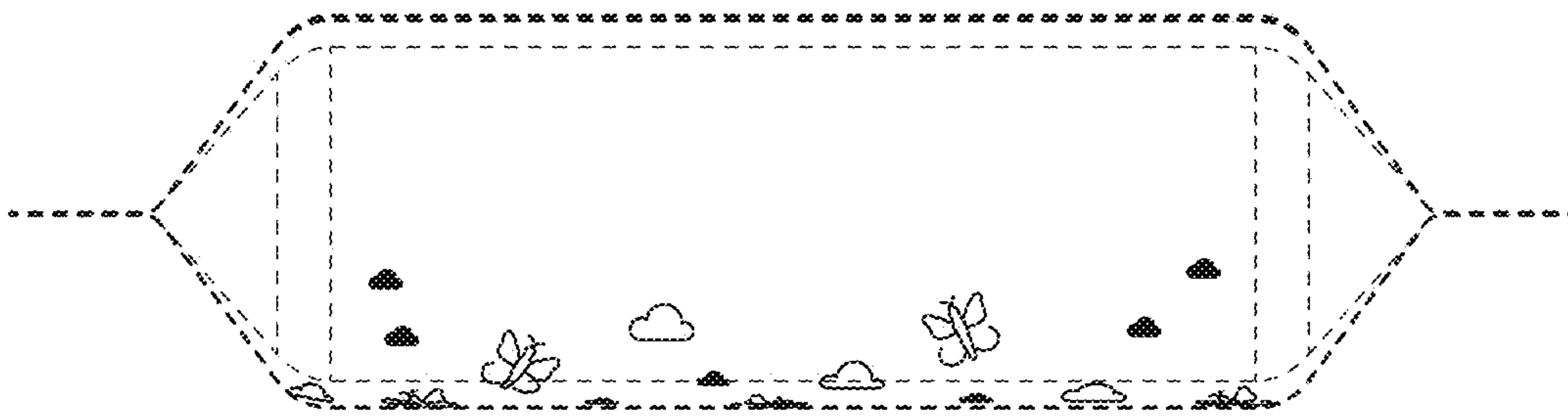

FIG. 14

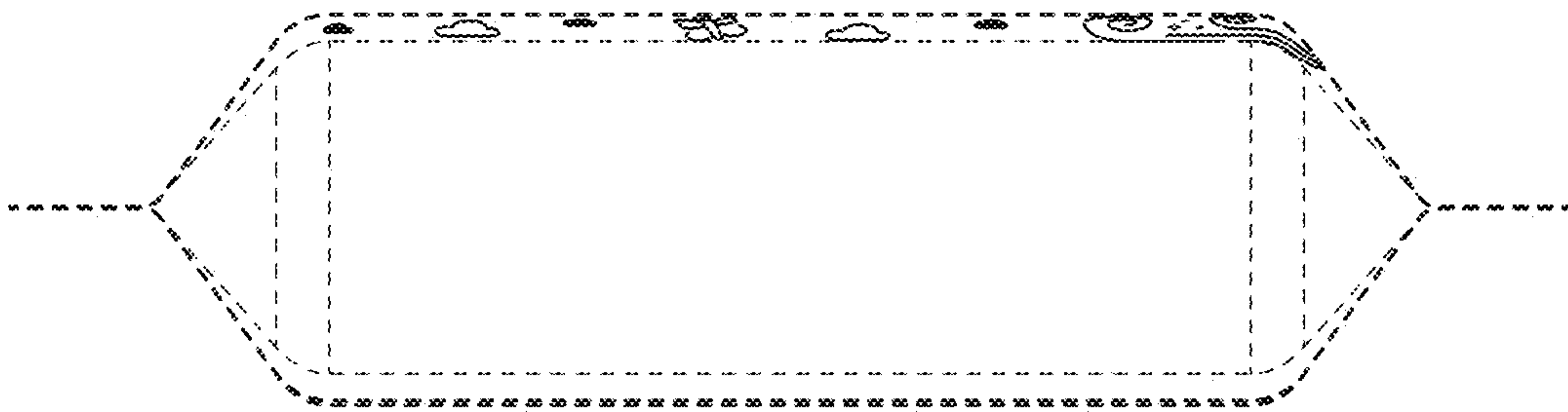

FIG. 15

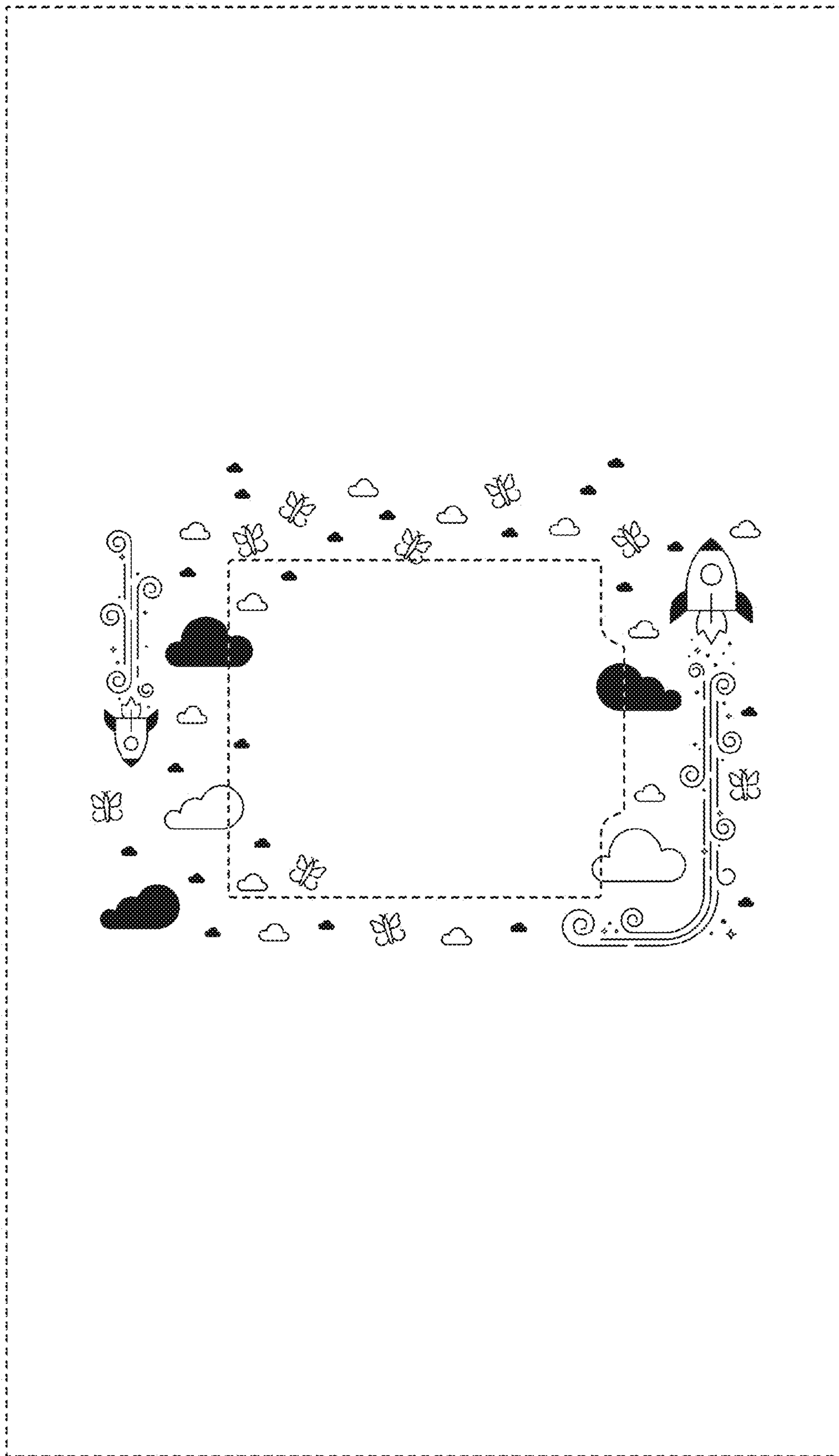

FIG. 16