

US00D975983S

(12) **United States Design Patent**
Greenspan

(10) **Patent No.:** **US D975,983 S**
(45) **Date of Patent:** **** Jan. 24, 2023**

(54) **SHOE**
(71) Applicant: **NIKE, Inc.**, Beaverton, OR (US)
(72) Inventor: **Joël Ryp Greenspan**, Portland, OR (US)
(73) Assignee: **NIKE, Inc.**, Beaverton, OR (US)
(**) Term: **15 Years**

(21) Appl. No.: **29/775,004**

(22) Filed: **Mar. 19, 2021**

(51) **LOC (14) Cl.** **02-04**

(52) **U.S. Cl.**
USPC **D2/972**

(58) **Field of Classification Search**
USPC D2/896, 897, 900, 902, 905, 906, 907, D2/908, 909, 925, 943, 944, 945, 946, D2/947, 951, 960, 969, 972, 973, 974, D2/976, 977
CPC A43B 3/242; A43B 3/244; A43B 3/246; A43B 5/00; A43B 5/02; A43B 5/06; A43B 5/10; A43B 5/001; A43B 5/002; A43B 7/06; A43B 7/08; A43B 13/00; A43B 13/02; A43B 13/023; A43B 13/12; A43B 13/122; A43B 13/125; A43B 13/127; A43B 13/14; A43B 13/141; A43B 13/16; A43B 13/18; A43B 13/184; A43B 13/28; A43B 13/34; A43B 23/00; A43B 23/02; A43B 23/04; A43B 23/07; A43B 23/0235; A43B 23/024; A43B 23/0265
See application file for complete search history.

(56) **References Cited**

U.S. PATENT DOCUMENTS

D318,364 S * 7/1991 McCrea D2/970
D325,291 S 4/1992 Hatfield
D329,131 S * 9/1992 Ostberg D2/953
D334,651 S * 4/1993 Smith D2/969

D343,503 S * 1/1994 Preskar D2/970
D344,404 S * 2/1994 Close D2/969
D345,047 S * 3/1994 DiSilvio D2/945
D345,459 S * 3/1994 Preskar D2/969
D372,577 S * 8/1996 Lozano D2/969
D401,399 S * 11/1998 von Conta D2/944
D412,395 S * 8/1999 von Conta D2/944

(Continued)

FOREIGN PATENT DOCUMENTS

EM 008631279-0028 * 2/2022

OTHER PUBLICATIONS

Jordan Air 200E, First available: Apr. 13, 2022 [online], [visited: Sep. 1, 2022] Available from the internet URL: <https://sneakernews.com/2022/04/13/jordan-air-200e-release-date/> (Year: 2022).*

(Continued)

Primary Examiner — Jonathan J Han
Assistant Examiner — Jeff Lenard D Torres
(74) *Attorney, Agent, or Firm* — Banner & Witcoff, Ltd.

(57) **CLAIM**

The ornamental design for a shoe, as shown and described.

DESCRIPTION

FIG. 1 is a rear perspective view of a shoe showing my new design;
FIG. 2 is a side view thereof;
FIG. 3 is a front perspective view thereof;
FIG. 4 is a front view thereof;
FIG. 5 is an opposite side front perspective view thereof;
FIG. 6 is an opposite side view thereof; and,
FIG. 7 is an opposite side rear perspective view thereof.
The broken lines within the shaded area represent eyelets that form no part of the claimed design. The broken lines depicting the remainder of the shoe form no part of the claimed design.

1 Claim, 7 Drawing Sheets

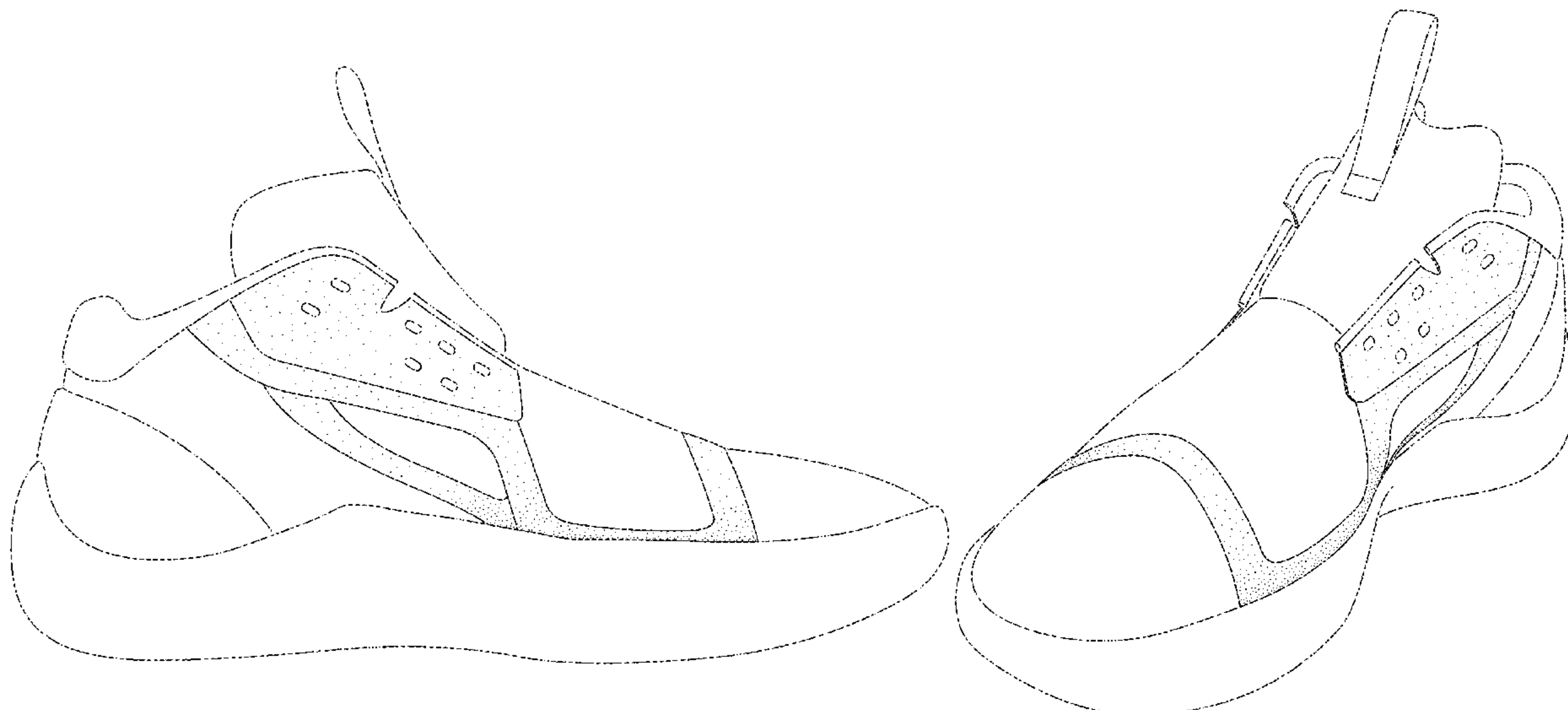

(56)

References Cited

OTHER PUBLICATIONS

U.S. PATENT DOCUMENTS

D455,250	S	*	4/2002	Wilson	D2/907
D490,221	S	*	5/2004	Edauw	D2/951
D544,684	S	*	6/2007	Lupo	D2/972
D544,694	S		6/2007	Glover		
D568,038	S	*	5/2008	Kuerbis	D2/972
D614,392	S	*	4/2010	Stauffer	D2/972
D688,039	S	*	8/2013	Williams, Jr.	D2/972
D693,108	S	*	11/2013	Chung	D2/972
D696,851	S	*	1/2014	Young	D2/972
D789,068	S		6/2017	Little		
D865,350	S	*	11/2019	Seamarks	D2/973
D880,838	S	*	4/2020	Rauner	D2/973
D885,015	S	*	5/2020	Platz	D2/907
D889,807	S	*	7/2020	Martin	D2/972
D915,036	S	*	4/2021	Sassi	D2/908
D937,558	S	*	12/2021	Han	D2/973
D943,958	S	*	2/2022	Winfield	D2/972

Luka Doncic's New Jordan Shoe, First available: Nov. 29, 2021 [online], [visited: Sep. 1, 2022] Available from the internet URL: <https://www.youtube.com/watch?v=SJqTCY6s-NU> (Year: 2021).*

Nike Jordan Zoom Separate PF Basketball Men's Shoes, First available: Feb. 11, 2022 [online], [visited: Sep. 1, 2022] Available from the internet URL: https://www.amazon.com/dp/B09RH1HZSP?ref_cm_sw_r_cp_ud_dp_6VB0F34845ZWNPHPGYBB (Year: 2022).*

"The Nike Zoom Freak 2 "Play For the Future" Enlists a Bright Purple and Mint Colorway"; Sneaker News; retrieved Mar. 17, 2021; published Feb. 2, 2021; URL: <<https://sneakernews.com/2021/02/02/nike-zoom-freak-2-purple-ck5424-500/>>.

* cited by examiner

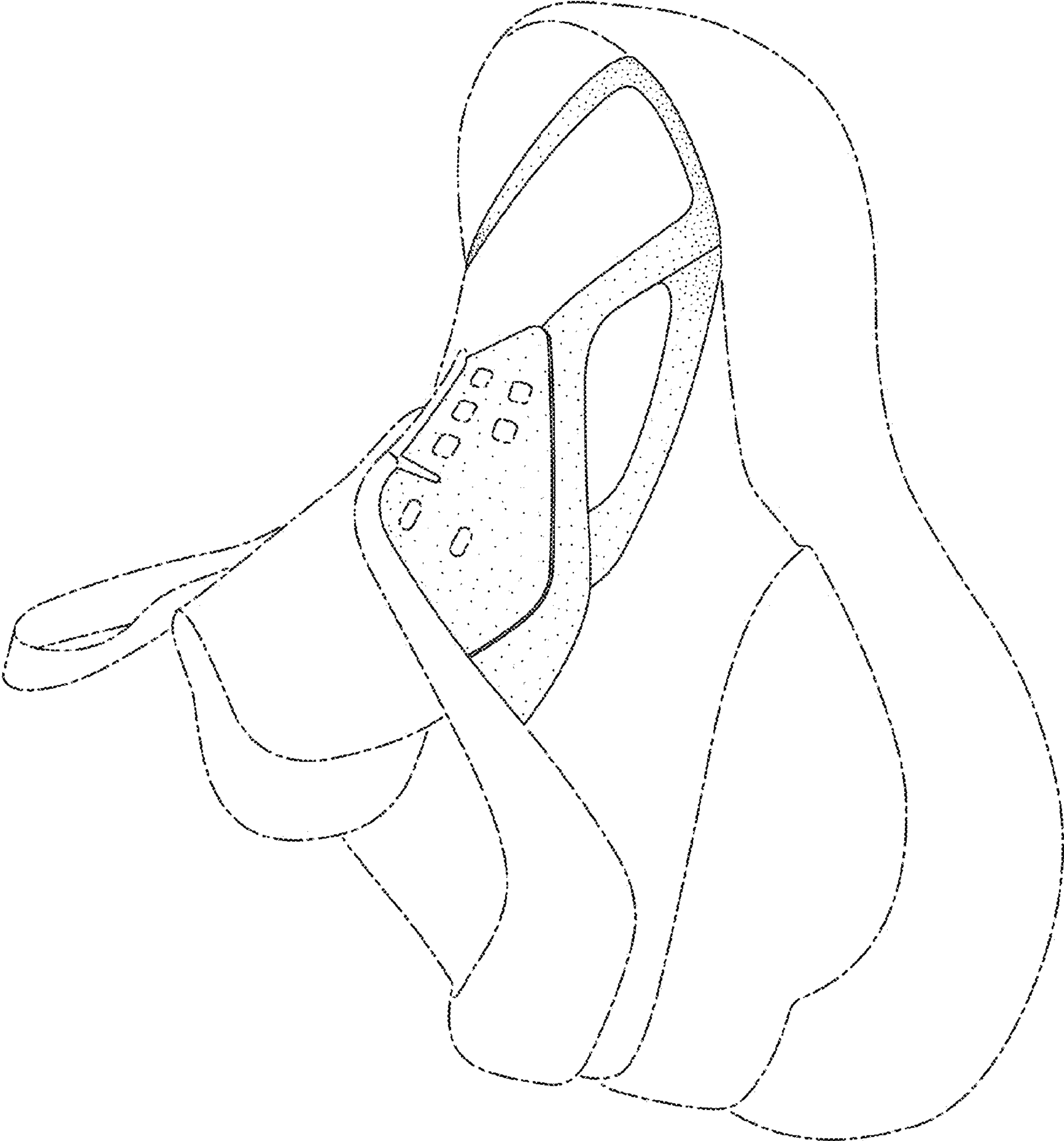

FIG. 1

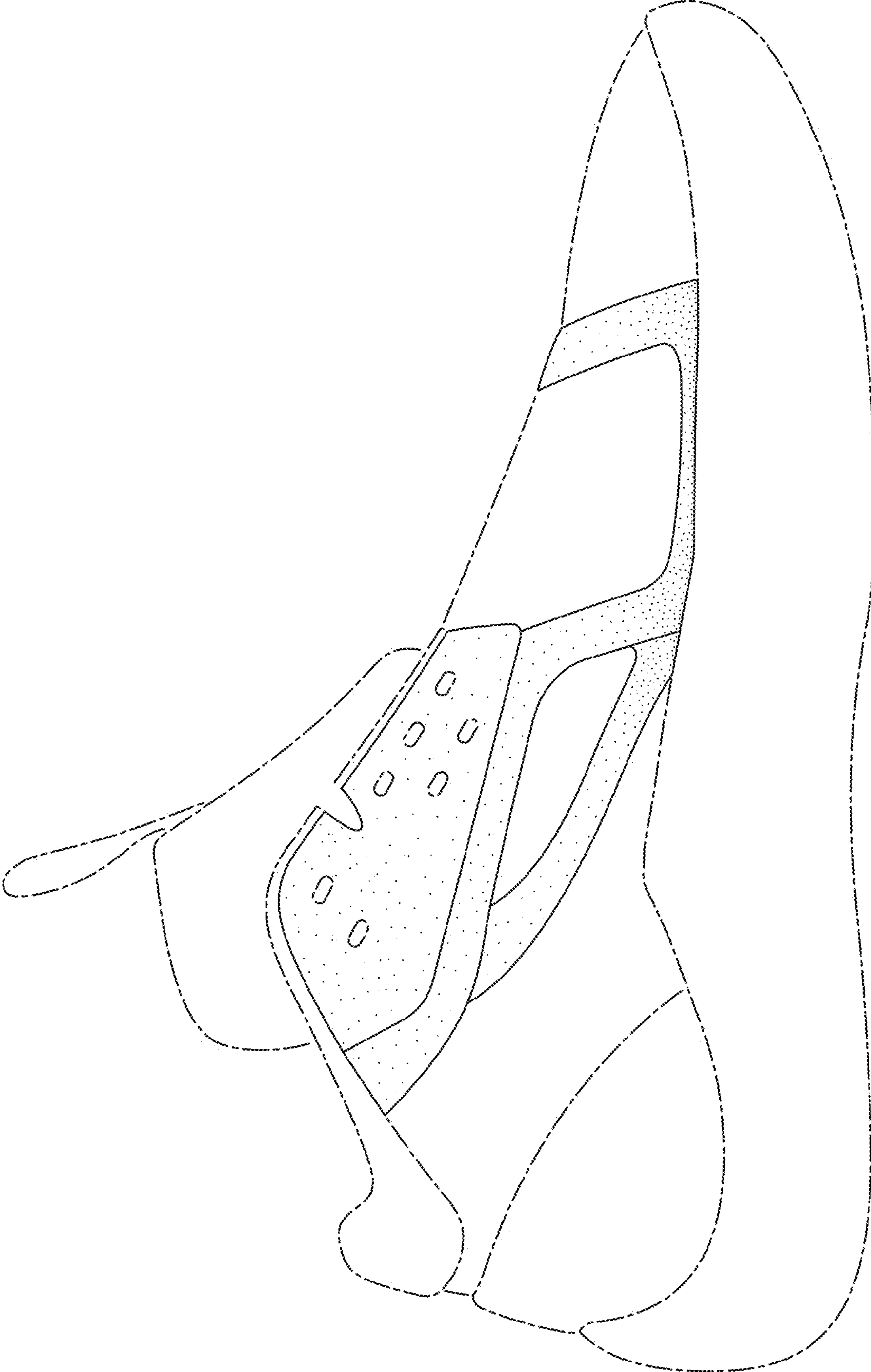

FIG. 2

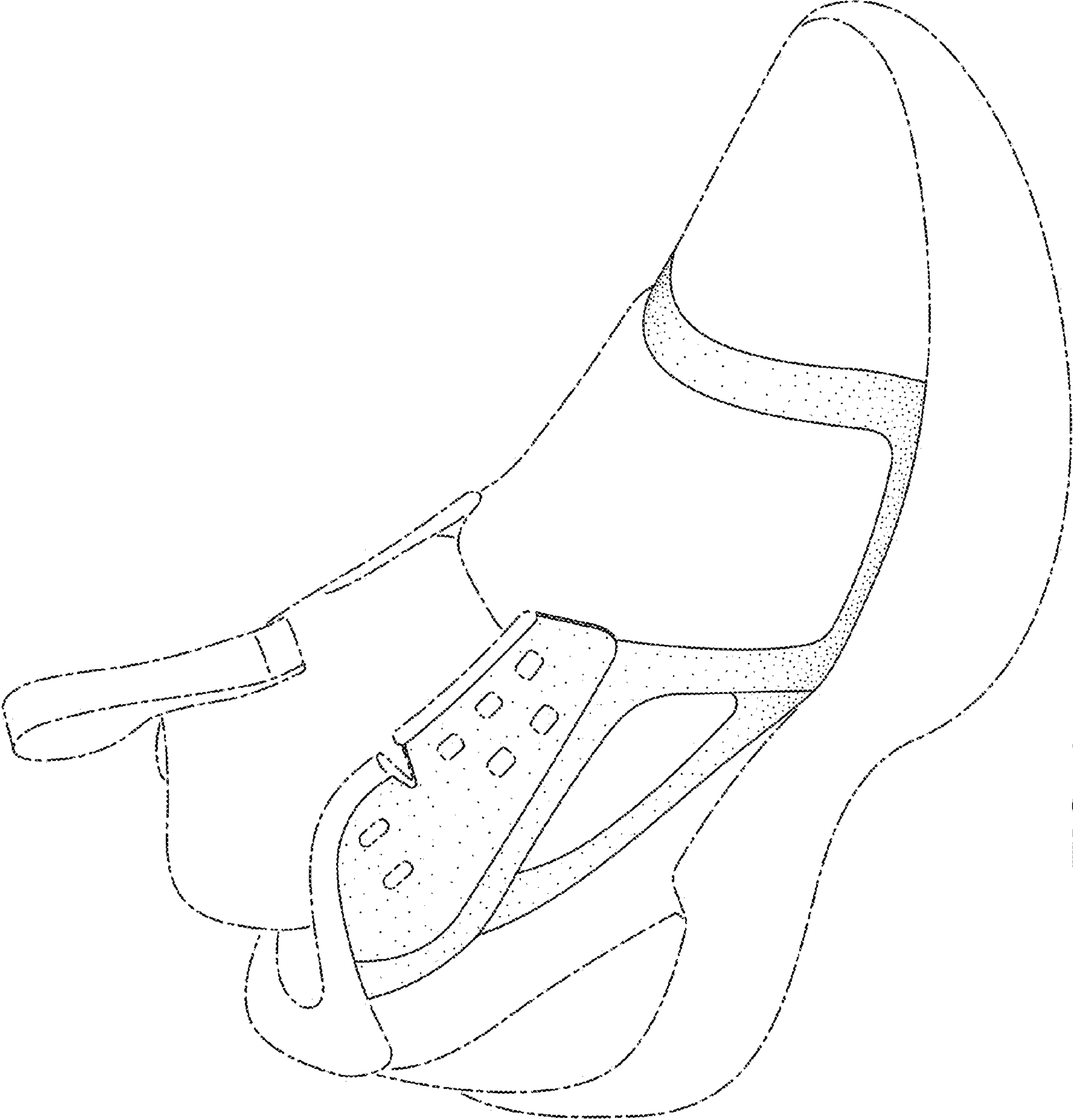

FIG. 3

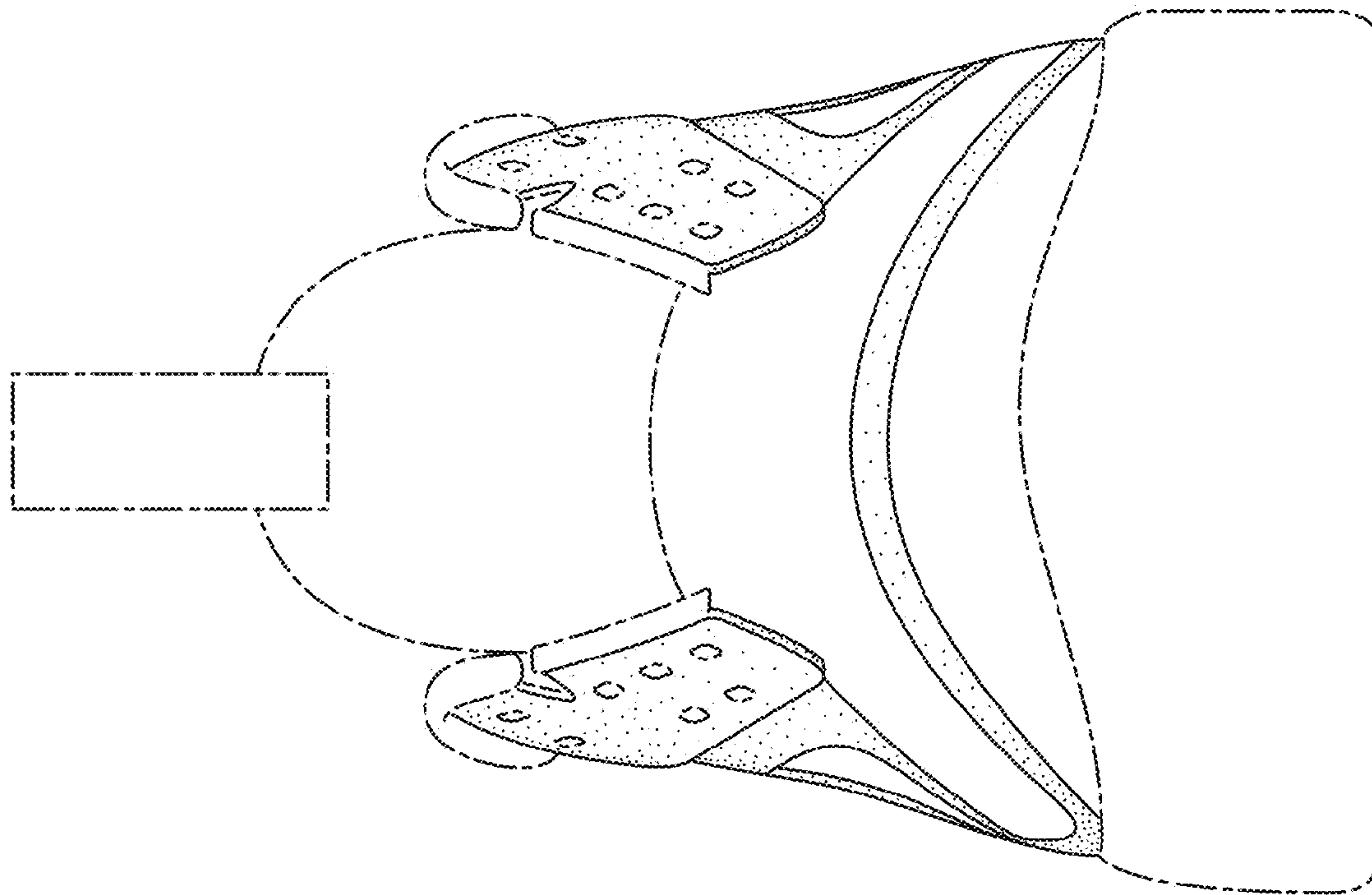

FIG. 4

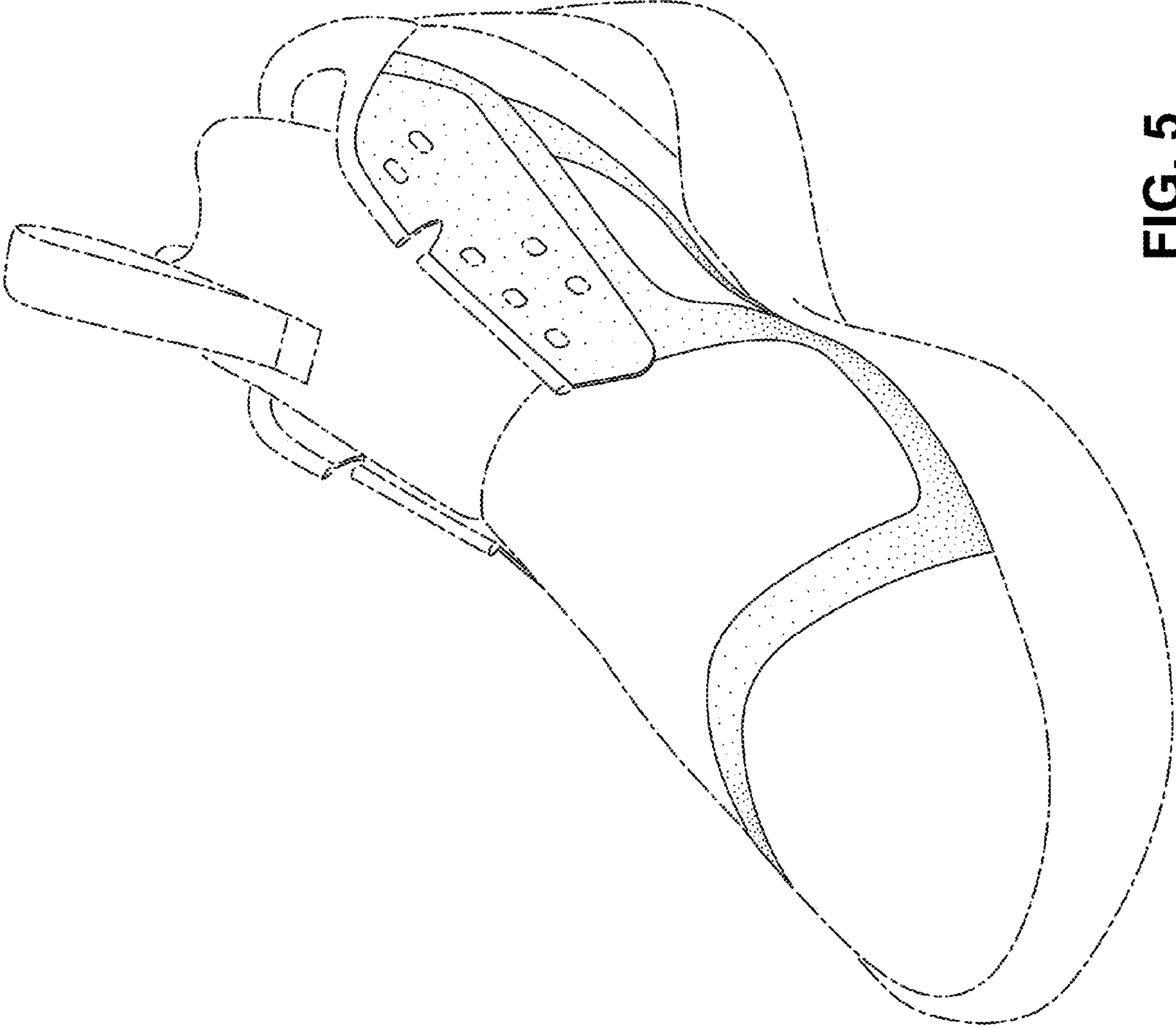

FIG. 5

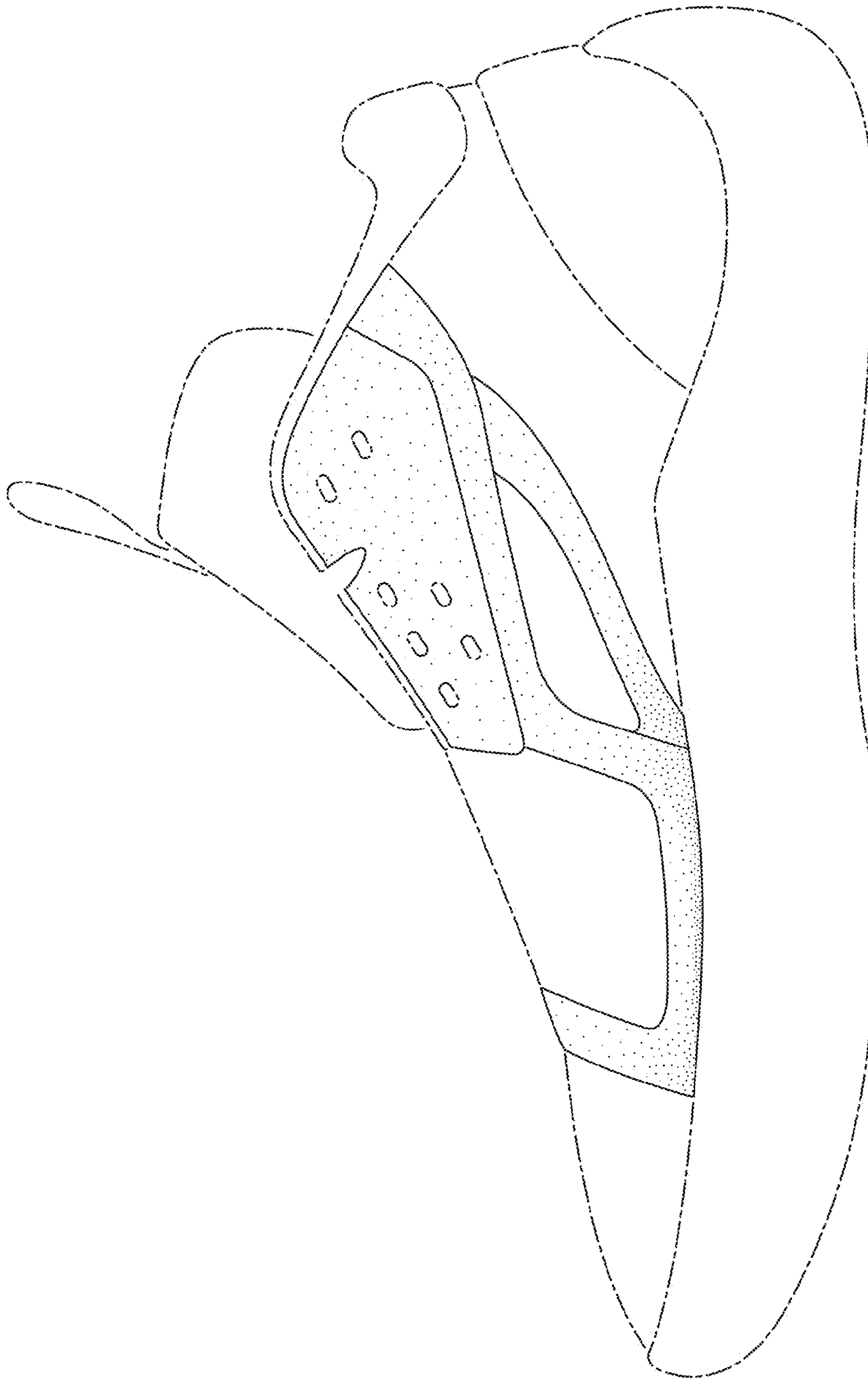

FIG. 6

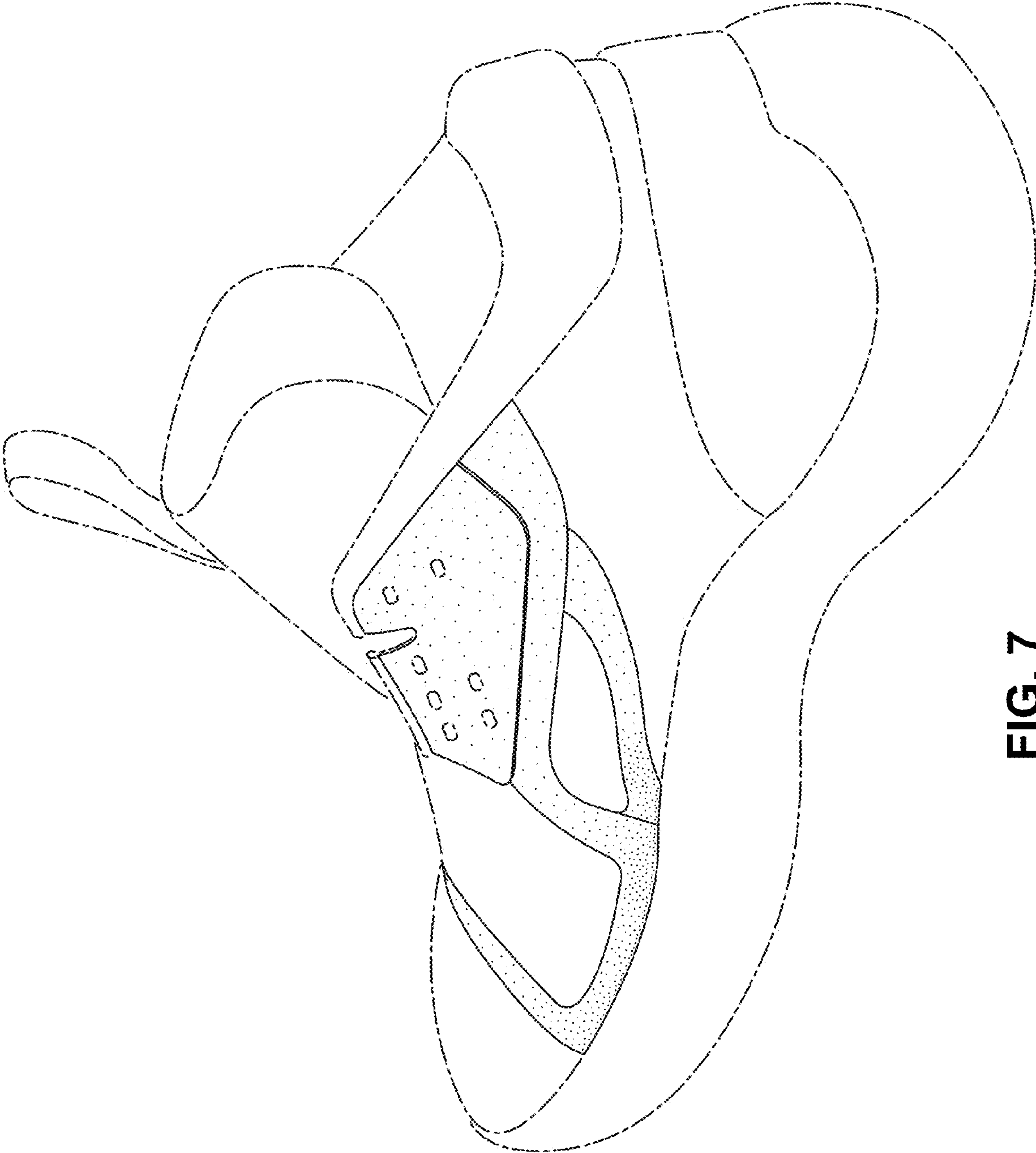

FIG. 7