



US00D975972S

(12) **United States Design Patent**
Foust

(10) **Patent No.:** **US D975,972 S**
(45) **Date of Patent:** **** Jan. 24, 2023**

(54) **BOOT**

(71) Applicant: **LaCrosse Footwear, Inc.**, Portland, OR (US)

(72) Inventor: **Ryan James Foust**, Portland, OR (US)

(73) Assignee: **LaCrosse Footwear, Inc.**, Portland, OR (US)

(**) Term: **15 Years**

(21) Appl. No.: **29/793,026**

(22) Filed: **May 26, 2021**

D304,128 S	10/1989	Kolman et al.
D305,889 S	2/1990	Plunkett et al.
D312,527 S	12/1990	Hatfield
D334,651 S	4/1993	Smith
D336,148 S	6/1993	Adams
D337,423 S	7/1993	Bailey
D345,047 S	3/1994	DiSilvio
D348,561 S	7/1994	Lozano
D351,937 S	11/1994	Hewett
D357,575 S	4/1995	Dahlsten
5,647,150 A	7/1997	Romanato et al.
D412,395 S	8/1999	von Conta et al.
D418,668 S	1/2000	Von
D426,372 S	6/2000	Price

(Continued)

Related U.S. Application Data

(63) Continuation of application No. 29/764,906, filed on Jan. 4, 2021, now Pat. No. Des. 922,739, which is a continuation of application No. 29/691,208, filed on May 14, 2019, now Pat. No. Des. 908,322.

(51) **LOC (14) Cl.** **02-04**

(52) **U.S. Cl.**
USPC **D2/912; D2/943**

(58) **Field of Classification Search**
USPC D2/896-900, 909-912, 920, 943, 944,
D2/946, 969, 970-974
CPC A43B 23/07; A43B 3/16; A43B 23/00;
A43B 23/02; A43B 5/04; A43B 3/02
See application file for complete search history.

(56) **References Cited**

U.S. PATENT DOCUMENTS

3,769,723 A	11/1973	Masterson et al.
4,222,183 A	9/1980	Haddox
4,447,967 A	5/1984	Zaino
4,459,765 A	7/1984	Power
D279,232 S	6/1985	Gamm
4,704,808 A	11/1987	Bianchini et al.
D298,981 S	12/1988	Gamm

OTHER PUBLICATIONS

Adrenaline GTS 21, BrooksRunning.com, [online], [site visited Jun. 2, 2021], Year 2021, 1 page. <https://www.brooksrunning.com/en-us/adrenaline-gts-21-womens-running-shoes/120329.html>.

(Continued)

Primary Examiner — Rashida C. Walshon
(74) *Attorney, Agent, or Firm* — Perkins Cole LLP

(57) **CLAIM**

The ornamental design for a boot, as shown and described.

DESCRIPTION

FIG. 1 is an isometric view of a boot showing the new design.

FIG. 2 is a right-side view thereof.

FIG. 3 is a left-side view thereof.

FIG. 4 is a front view thereof.

FIG. 5 is a rear view thereof.

FIG. 6 is a top view thereof; and,

FIG. 7 is a bottom view thereof.

The broken lines in the drawings represent portions of the boot that form no part of the claim.

1 Claim, 7 Drawing Sheets

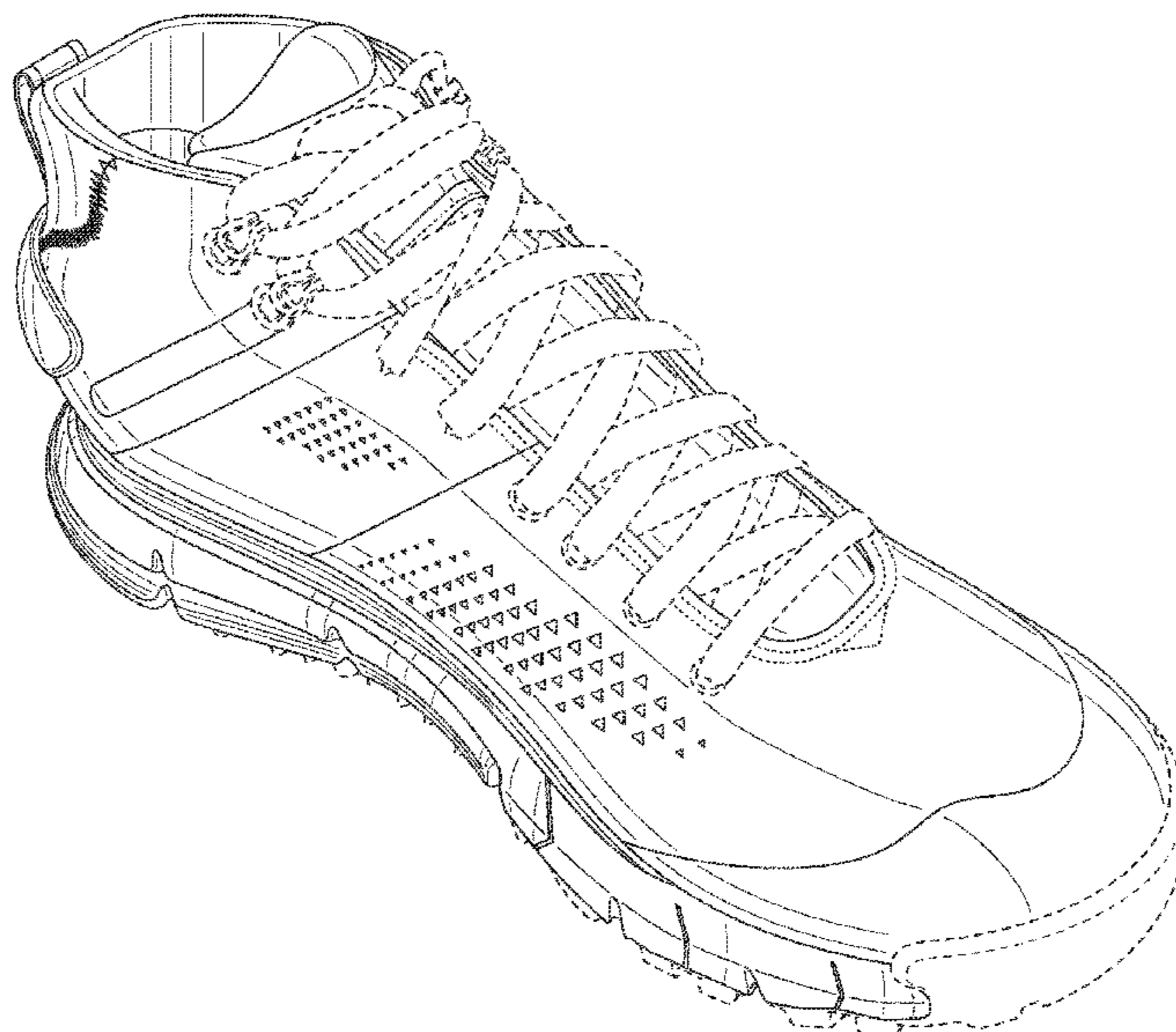

(56)

References Cited

U.S. PATENT DOCUMENTS

D431,712 S 10/2000 Wilson
 D446,638 S 8/2001 Ammon
 D448,921 S 10/2001 Ammon
 6,298,582 B1 10/2001 Friton et al.
 D462,511 S 9/2002 Price
 D489,522 S 5/2004 Benini
 D499,538 S 12/2004 Burg et al.
 D500,199 S 12/2004 Clegg
 D510,473 S 10/2005 Burg
 D514,296 S 2/2006 Erickson et al.
 D514,798 S 2/2006 Avar
 D522,730 S 6/2006 Holmes
 D528,772 S 9/2006 Portzline
 D541,801 S 5/2007 Elwell et al.
 D544,684 S 6/2007 Lupo
 D554,343 S 11/2007 Matis et al.
 D565,283 S 4/2008 Smith et al.
 D568,585 S 5/2008 Dolce et al.
 D572,002 S 7/2008 Alfaro
 D574,587 S 8/2008 Mcdowell
 D576,385 S * 9/2008 Della Valle D2/908
 D576,386 S 9/2008 Della
 D577,185 S * 9/2008 Link D2/969
 D581,636 S 12/2008 Graber
 D590,138 S 4/2009 Cofinco
 7,540,097 B2 6/2009 Greene et al.
 D603,596 S 11/2009 Feeney et al.
 D608,539 S 1/2010 Roundhouse
 D613,480 S 4/2010 Lamont
 D613,934 S 4/2010 Taylor
 7,757,412 B2 7/2010 Farys
 D620,689 S 8/2010 Weber
 D628,365 S 12/2010 Bourdin et al.
 D629,185 S 12/2010 Vico et al.
 D631,234 S 1/2011 Kasprzak
 D637,799 S 5/2011 Della et al.
 8,065,818 B2 11/2011 Greene et al.
 D659,971 S 5/2012 Hurayt
 D667,624 S 9/2012 Lonigan
 D671,727 S 12/2012 Yi
 D672,942 S 12/2012 Della et al.
 D675,424 S 2/2013 Williams
 D678,667 S 3/2013 Carboy
 D680,712 S 4/2013 Della et al.
 D681,316 S 5/2013 Della et al.
 D682,515 S 5/2013 Della et al.
 D683,129 S 5/2013 Fogg
 8,490,303 B2 7/2013 Kasprzak
 D694,506 S 12/2013 Anceresi et al.
 D703,932 S 5/2014 Avar et al.
 D713,133 S 9/2014 Della et al.
 8,850,723 B2 10/2014 Greene et al.
 D718,033 S 11/2014 Cin
 D725,354 S 3/2015 Della et al.
 D727,002 S 4/2015 Sassi
 D728,205 S 5/2015 Weddle et al.
 D728,213 S 5/2015 Mochen et al.
 D731,765 S 6/2015 Opie
 D735,455 S 8/2015 Mochen et al.
 D737,553 S 9/2015 Della et al.
 D737,554 S 9/2015 Della et al.
 D738,084 S 9/2015 Feeney
 D738,096 S 9/2015 Rasmussen
 D740,002 S 10/2015 Della et al.
 D745,771 S 12/2015 Cin
 D747,087 S 1/2016 Sars
 D752,322 S 3/2016 Tomat
 D758,710 S 6/2016 Bacon
 D770,159 S 11/2016 Williams et al.

D773,795 S 12/2016 Lok
 D793,065 S 8/2017 Cin
 D793,694 S 8/2017 Tresser
 D795,563 S 8/2017 Durand
 D796,818 S 9/2017 Chang
 D801,026 S 10/2017 Vanhook
 D802,282 S 11/2017 Wright
 D802,286 S 11/2017 Klein
 D805,743 S 12/2017 Feeney et al.
 D816,978 S 5/2018 Small
 D826,531 S 8/2018 Ringholz et al.
 D831,311 S 10/2018 Pulli
 D833,126 S 11/2018 Laska
 D834,294 S * 11/2018 Small D2/969
 D838,966 S * 1/2019 Pauk D2/972
 10,238,171 B2 3/2019 Mocos et al.
 D848,123 S 5/2019 Gallo
 D848,124 S 5/2019 Sassi
 D851,380 S 6/2019 De Montgolfier et al.
 D851,871 S 6/2019 Gallo
 D859,793 S 9/2019 Vasyli et al.
 D866,130 S 11/2019 O'Boyle
 D883,639 S 5/2020 Phillips
 D883,640 S 5/2020 Foust
 D884,331 S * 5/2020 Kanata D2/972
 D891,042 S 7/2020 Gallo
 D893,157 S 8/2020 Amago
 D893,848 S 8/2020 Swierszczyk
 D900,437 S 11/2020 Mazza
 D905,937 S 12/2020 Lee
 D906,642 S 1/2021 Zhang et al.
 D908,322 S 1/2021 Foust
 D909,733 S * 2/2021 Hardman D2/972
 D912,372 S 3/2021 Smith
 D912,373 S 3/2021 Smith
 D913,671 S * 3/2021 Suh D2/969
 D922,739 S 6/2021 Foust
 D929,707 S * 9/2021 Suh D2/951
 D932,750 S * 10/2021 Oleson D2/947
 D943,910 S * 2/2022 Foust D2/972
 2003/0196354 A1 10/2003 Chu
 2006/0017195 A1 1/2006 Yang
 2014/0196308 A1 7/2014 Baratta et al.
 2014/0237858 A1 8/2014 Adami et al.
 2016/0007687 A1 1/2016 Surace et al.

OTHER PUBLICATIONS

Court Sneakers in White Leather, Madewell.com, [online], [site visited Jun. 2, 2021], Year 2021, 1 page. www.madewell.com/court-sneakers-in-white-leather-MC696.html?srcCode=affiliate|Content|Cond%C3%A9+Nast|MWAFFI00001&siteId=CJ_8984093_Cond_%C3%A9+Nast&utm_source.
 CX 201, LakeCycling.com, [online], [site visited Jun. 2, 2021], Year 2021, 1 page. <https://lakecycling.com/>.
 Novesta Marathon Trail Runner, EndClothing.com [online] [site visited Jun. 2, 2021], Year 2021, 1 page. www.endclothing.com/us/novesta-marathon-trail-runner-nvsta-mthtrl-1.html?awc=%2017185_%201622660532_ea522d%201007%20491283f75acc17c629c80b&utm_source=%20awin&utm_medium=affiliate&utm_campaign=Skimlinks.
 Sneakers, Chanel.com, [online], [site visited Jun. 2, 2021], Year 2021, 1 page. <https://www.chanel.com/us/fashion/p/G37488X56157K2828/sneakers-fabric/>.
 Ultrapace Sneaker—Women's, DSW.com, [online], [site visited Jun. 2, 2021], Year 2021, 1 page. www.dsw.com/en/us/product/gucci-ultrapace-sneaker---womens/500684?activeColor=040&clickid=Xa0y19RRixyLUth0TWXZ0S3wUkBzao0niQ6:x40&irgwc=1&cm_mmc=affil_-_Skimbit%20Ltd.

* cited by examiner

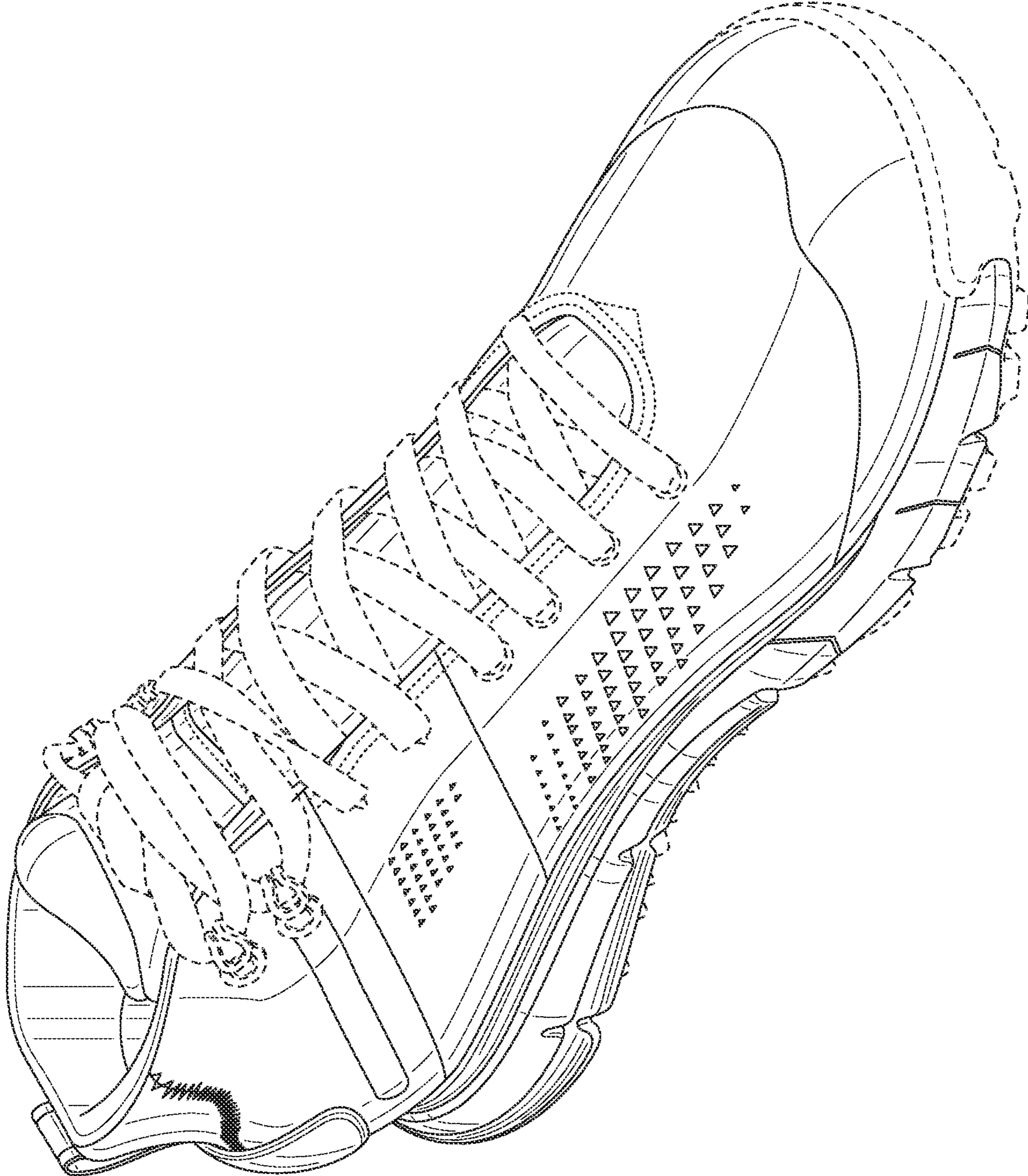

Fig. 1

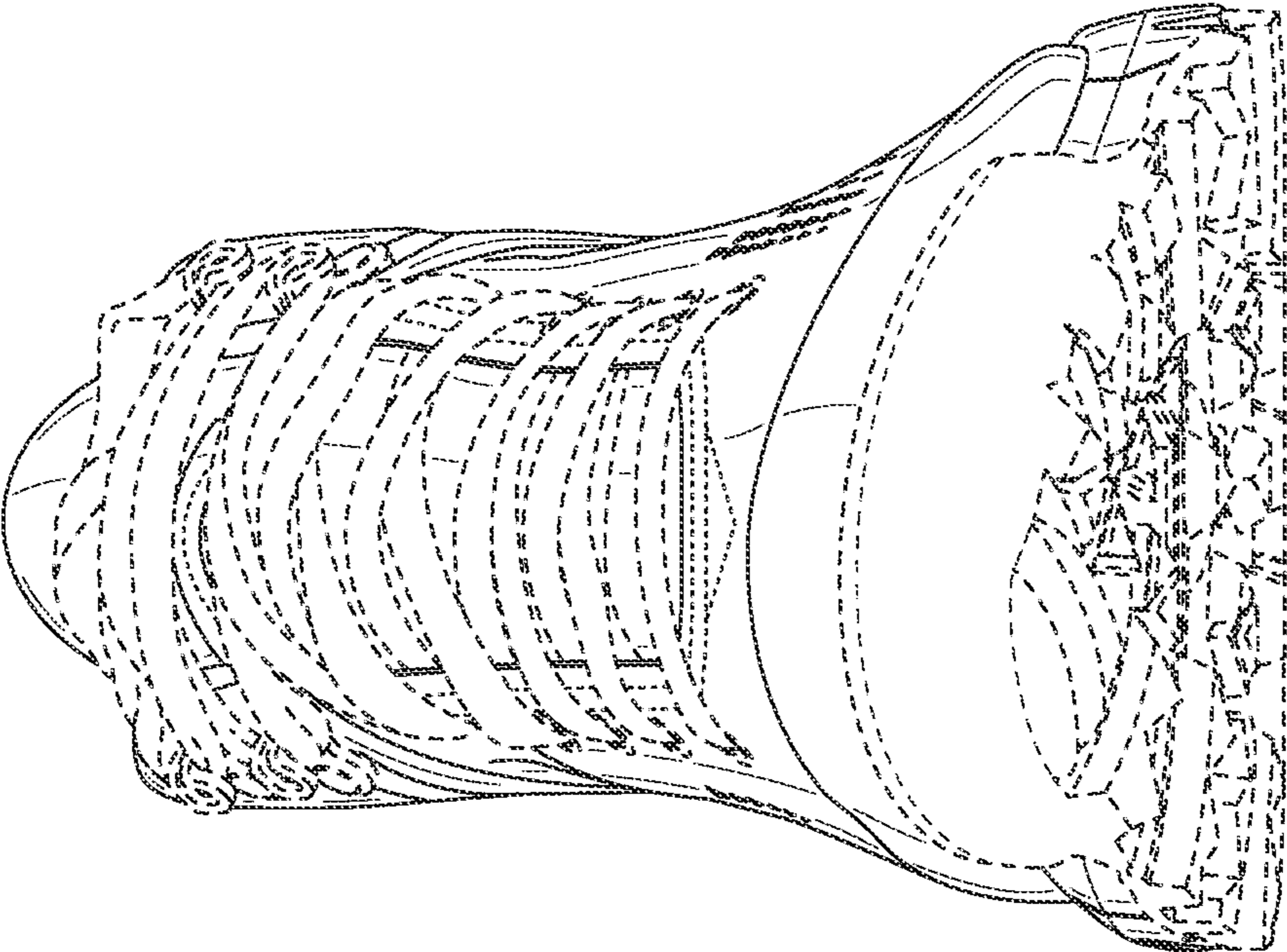

Fig. 2

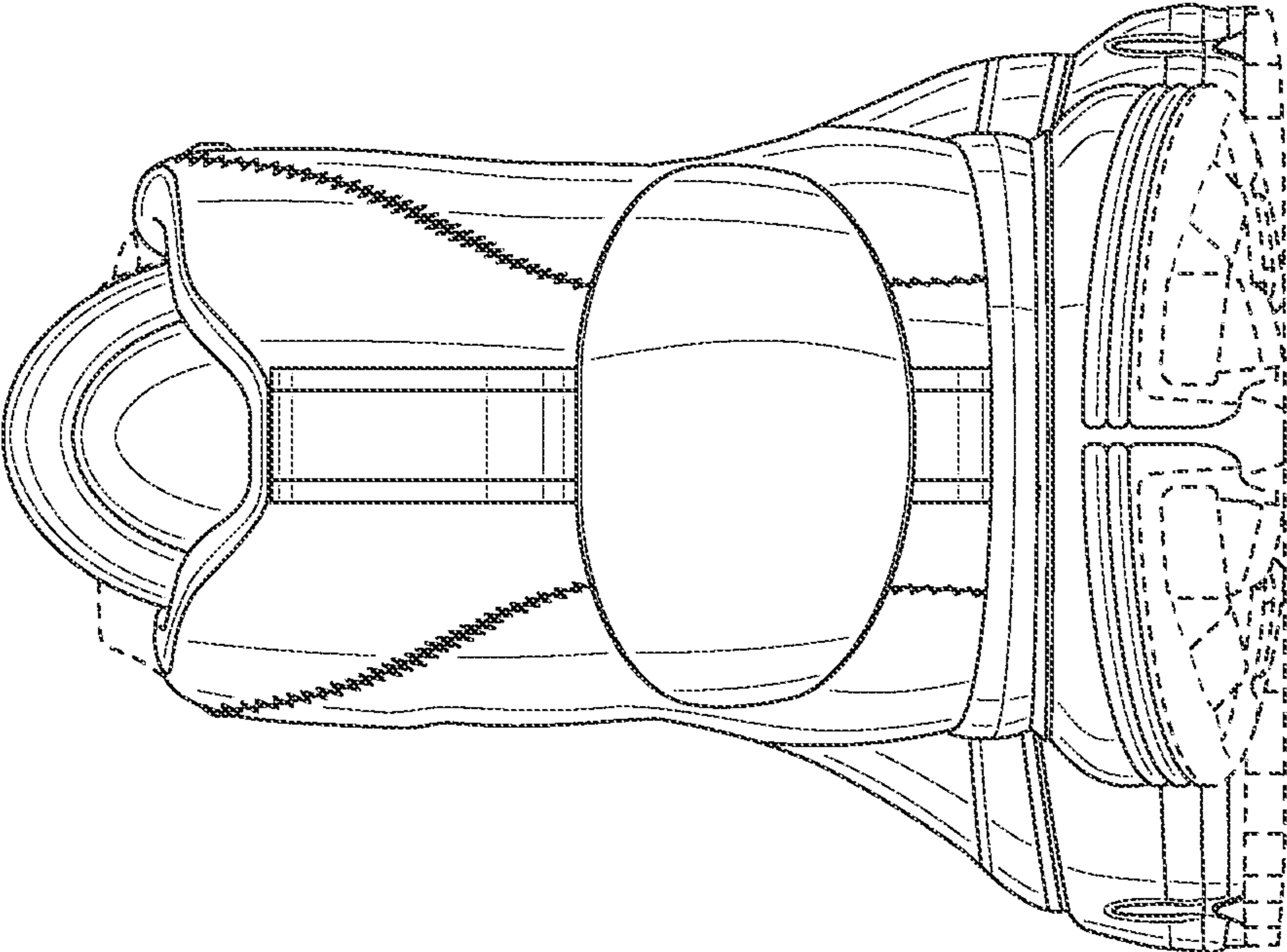

Fig. 3

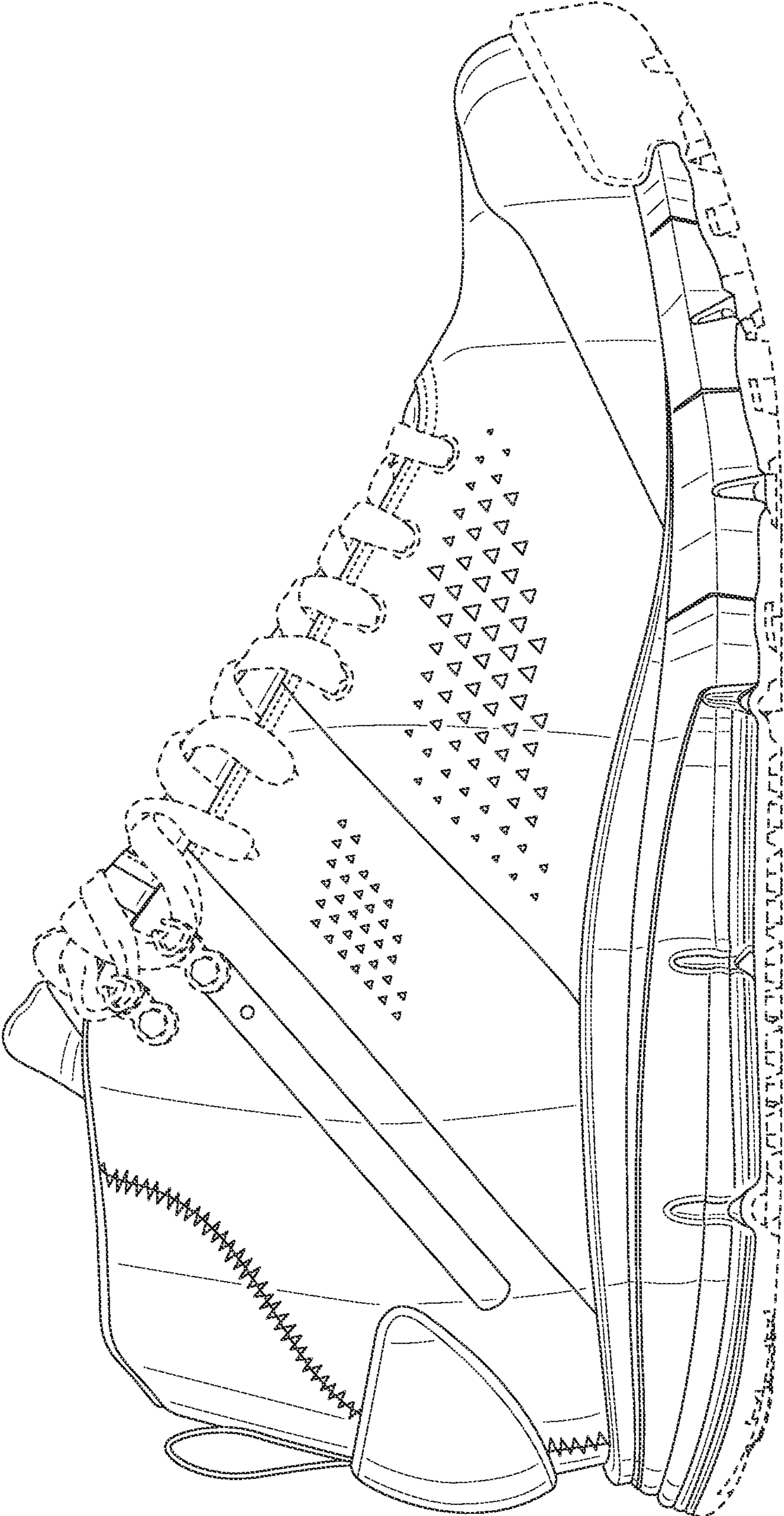

Fig. 4

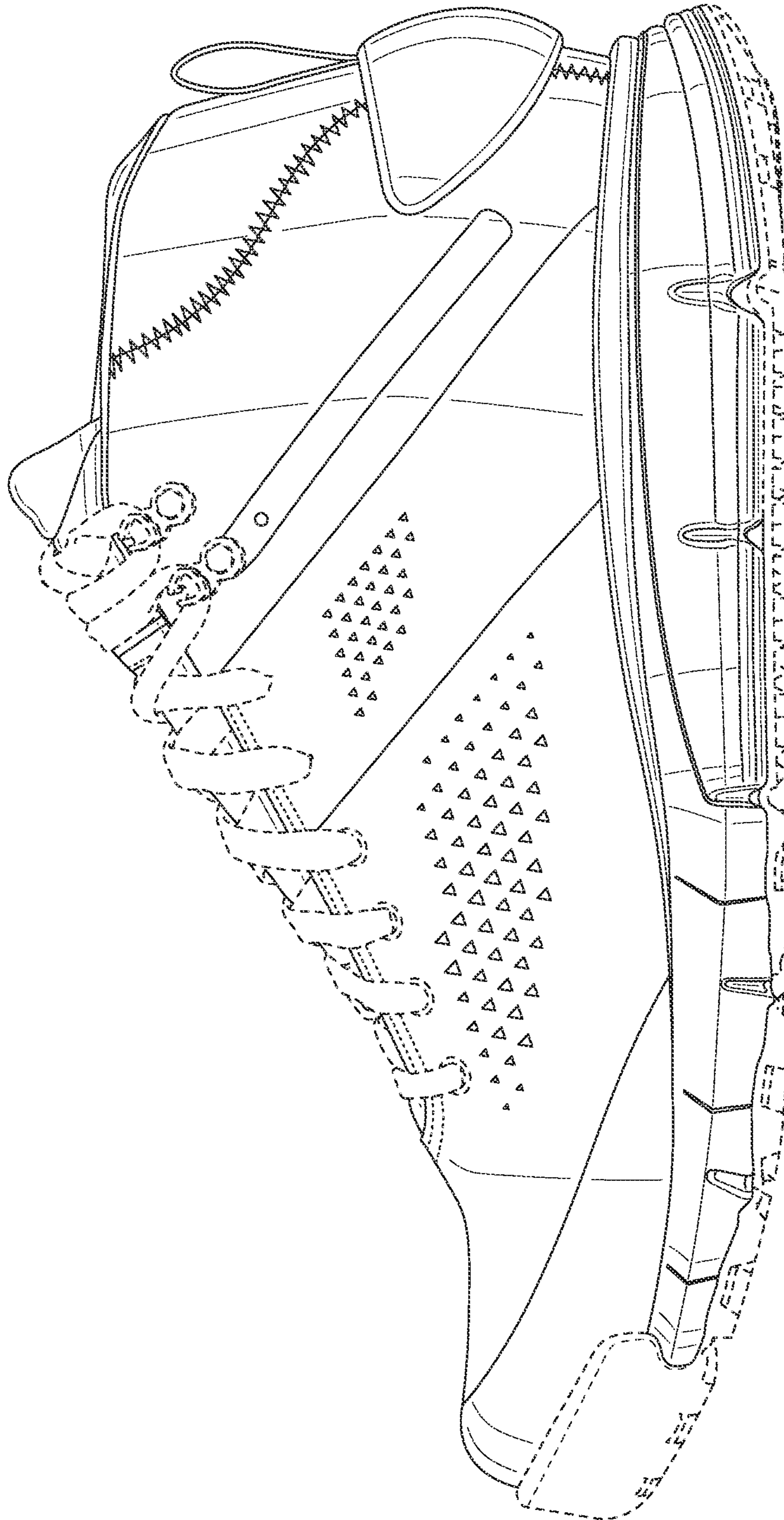

Fig. 5

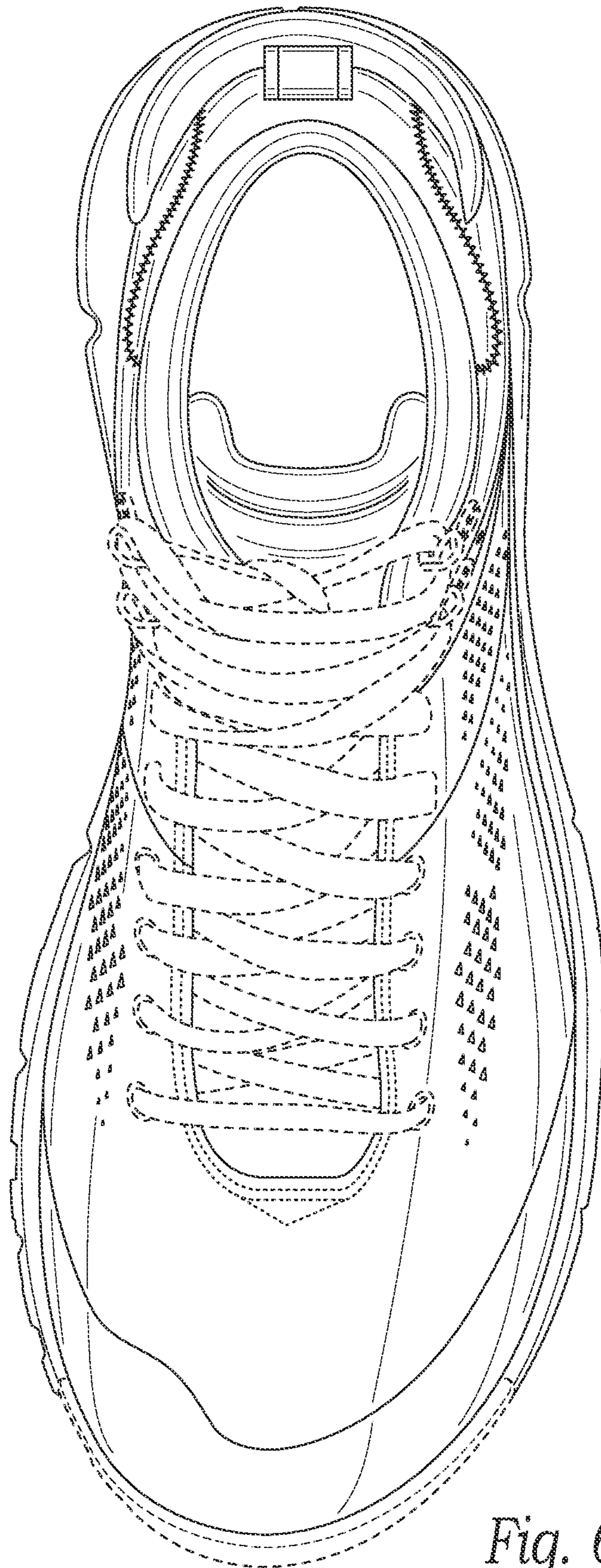

Fig. 6

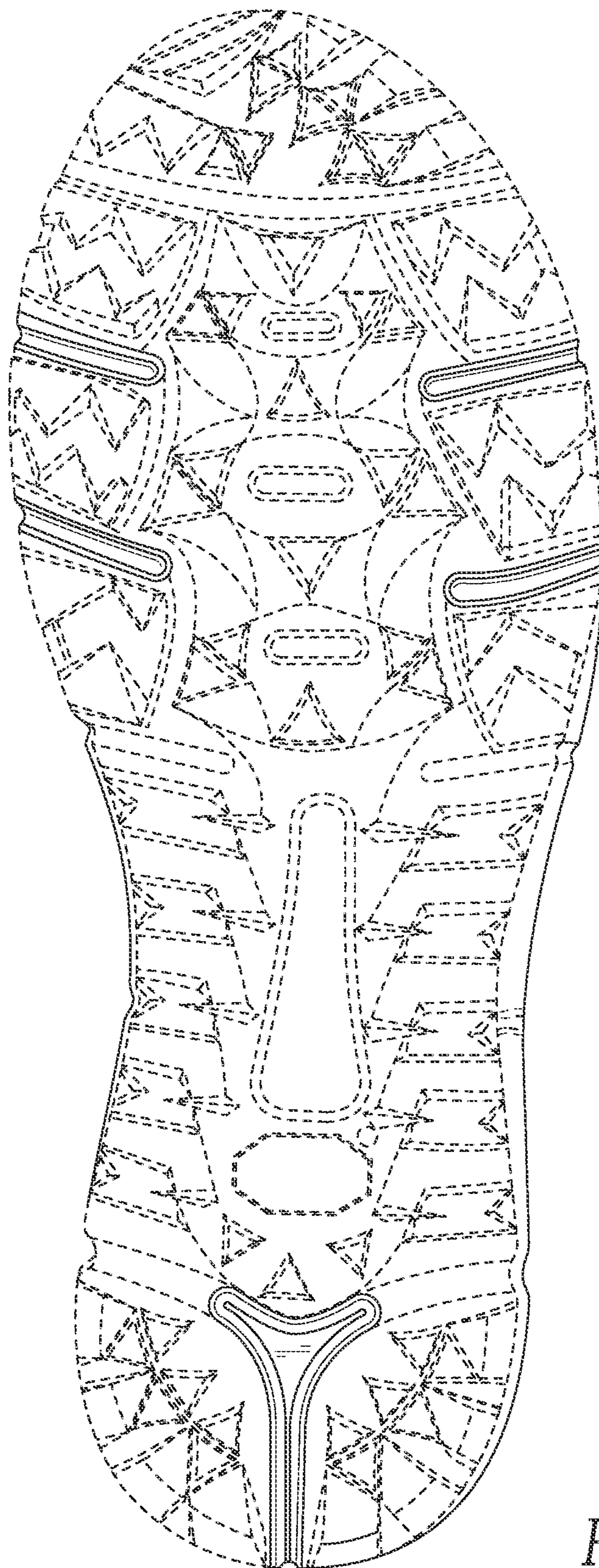

Fig. 7