



US00D975954S

(12) **United States Design Patent** (10) **Patent No.:** **US D975,954 S**
Iwata et al. (45) **Date of Patent:** **** Jan. 17, 2023**

(54) **RAIL FOR CONVEYOR MACHINE**

(71) Applicant: **Daifuku Co., Ltd.**, Osaka (JP)

(72) Inventors: **Masashige Iwata**, Hinocho (JP);
Hiroaki Nakamura, Hinocho (JP)

(73) Assignee: **Daifuku Co., Ltd.**, Osaka (JP)

(**) Term: **15 Years**

(21) Appl. No.: **29/736,217**

(22) Filed: **May 28, 2020**

(30) **Foreign Application Priority Data**

Dec. 2, 2019 (JP) 2019-026739
Dec. 2, 2019 (JP) 2019-026740

(51) **LOC (14) Cl.** **12-05**

(52) **U.S. Cl.**
USPC **D34/29; D25/119**

(58) **Field of Classification Search**
USPC D34/29, 35; D25/119, 122, 123, 124,
D25/125, 126, 128; 198/838
(Continued)

(56) **References Cited**

U.S. PATENT DOCUMENTS

4,951,809 A * 8/1990 Boothe B65G 21/02
198/841

D325,277 S * 4/1992 Abbestam D34/35
(Continued)

FOREIGN PATENT DOCUMENTS

DE 20307005 U1 8/2003
DE 10241347 B4 2/2007

OTHER PUBLICATIONS

MISUMI-ec.com, searched Mar. 23, 2022, UHMW guide Rail Shields, <https://us.misumi-ec.com/vona2/detail/110300140370/> (Year: 2022).*

(Continued)

Primary Examiner — Cynthia Ramirez

(74) *Attorney, Agent, or Firm* — The Webb Law Firm

(57) **CLAIM**

The ornamental design for a rail for conveyor machine, as shown and described.

DESCRIPTION

FIG. 1 is a front elevation view of a rail for conveyor machine showing our new design in accordance with a first embodiment of the present invention;

FIG. 2 is a rear elevation view thereof;

FIG. 3 is a left side elevation view thereof, the right side elevation view being a mirror image thereof;

FIG. 4 is a top view thereof;

FIG. 5 is a bottom view thereof;

FIG. 6 is a front, right side, top perspective view thereof;

FIG. 7 is a rear, left side, top perspective view thereof;

FIG. 8 is an enlarged left side elevation view thereof;

FIG. 9 is a partial enlarged view of FIG. 6 thereof;

FIG. 10 is a partial enlarged view of FIG. 7 thereof;

FIG. 11 is a perspective view thereof in its intended environment;

FIG. 12 is front elevation view of a rail for conveyor machine showing our new design in accordance with a second embodiment of the present invention;

FIG. 13 is a rear elevation view thereof;

FIG. 14 is a left side elevation view thereof, the right side elevation view being a mirror image thereof;

FIG. 15 is a top view thereof;

FIG. 16 is a bottom view thereof;

FIG. 17 is a front, right side, top perspective view thereof;

FIG. 18 is a rear, left side, top perspective view thereof;

FIG. 19 is an enlarged left side elevation view thereof;

FIG. 20 is a partial enlarged view of FIG. 17 thereof;

FIG. 21 is a partial enlarged view of FIG. 18 thereof; and,

FIG. 22 is a perspective view thereof in its intended environment.

The broken lines shown in FIGS. 1, 2, 6, 7, 9-13, 17, 18, and 20-22 form no part of the claimed design. The broken lines in FIGS. 1, 2, 6, 7, 9, 10, 12, 13, 17, 18, 20, and 21 show disclaimed portions of the rail and form no part of the claimed design, and the broken lines shown in FIGS. 11 and

(Continued)

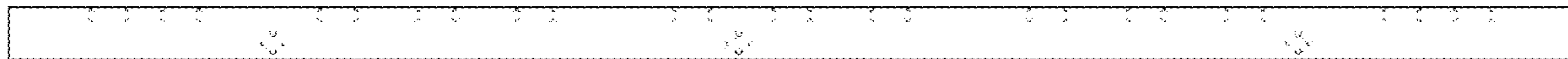

22 are for the purpose of illustrating the environment around the rail and form no part of the claimed design.

1 Claim, 22 Drawing Sheets

(58) Field of Classification Search

CPC E04F 19/022; E04F 19/061; E04F 19/062;
E04F 19/064; E04F 19/065; B65G 17/20;
E04H 12/2292

See application file for complete search history.

(56) References Cited

U.S. PATENT DOCUMENTS

5,137,145	A *	8/1992	Clopton	B65G 21/06 198/860.1
5,598,784	A *	2/1997	Kubsik	B65G 21/06 104/111
D379,237	S *	5/1997	Leonelli	D25/119
D384,470	S *	9/1997	Kubsik	D34/29
D384,471	S *	9/1997	Kubsik	D34/29
5,788,056	A *	8/1998	Clopton	B65G 13/11 198/779
6,360,508	B1 *	3/2002	Pelfrey	E04F 13/0864 52/552
6,612,426	B1 *	9/2003	Guerra	B65G 21/22 198/841

D489,209	S *	5/2004	Goldberg	D25/119
7,086,525	B2 *	8/2006	Kilby	F16G 13/10 198/852
D609,825	S	2/2010	Clarke et al.	
D670,474	S *	11/2012	Koch	B66C 7/02 D34/35
8,627,943	B2 *	1/2014	Oppliger	B65G 17/20 198/470.1
D764,075	S *	8/2016	Honda	D25/119
D764,140	S *	8/2016	Holzhaeuser	D34/33
D790,799	S *	6/2017	Holzhaeuser	D34/35
D791,975	S *	7/2017	Nelson	D25/119
D859,611	S *	9/2019	Gori	D25/119
D893,762	S *	8/2020	Lake	D25/124
D928,346	S *	8/2021	Cube	D25/126
D940,354	S *	1/2022	Jung	D25/119
D942,647	S *	2/2022	Ferris	D25/124
D944,076	S *	2/2022	Quatraro	D25/119
2008/0226432	A1	9/2008	Freudelsperger	

OTHER PUBLICATIONS

Wuhanmarch-china.com searched Mar. 23, 2022, Galvanized Steel C-Rail Cable Festoon System C30DJ, <https://www.wuhanmarch-china.com/showroom/galvanized-steel-c-rail-cable-festoon-system-c30dj-hanger.html> (Year: 2022).*

Amazon.es searched Mar. 23, 2022, Carril de Montaje Din 10 piezas carril din aluminio, <https://www.amazon.es/dp/B092QVZS99> (Year: 2022).*

* cited by examiner

Fig. 1



Fig. 2

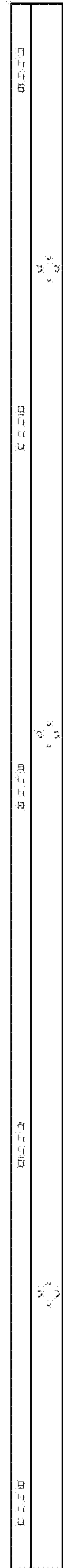

Fig. 3

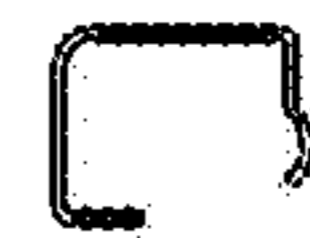

Fig.4

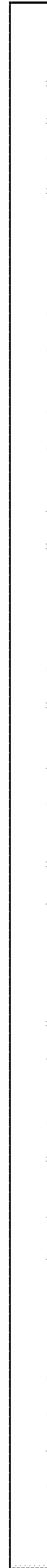

Fig. 5



Fig. 6

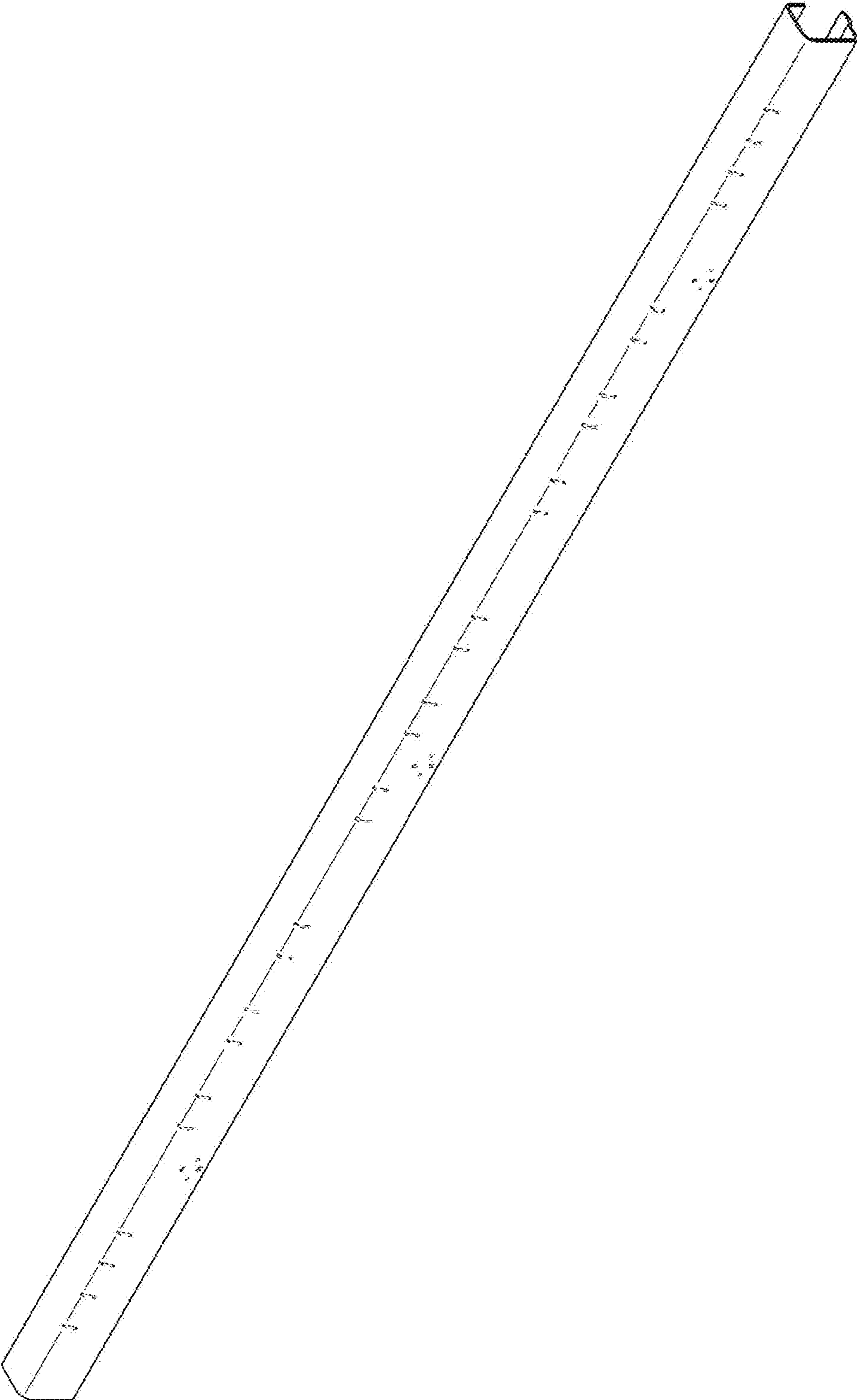

Fig. 7

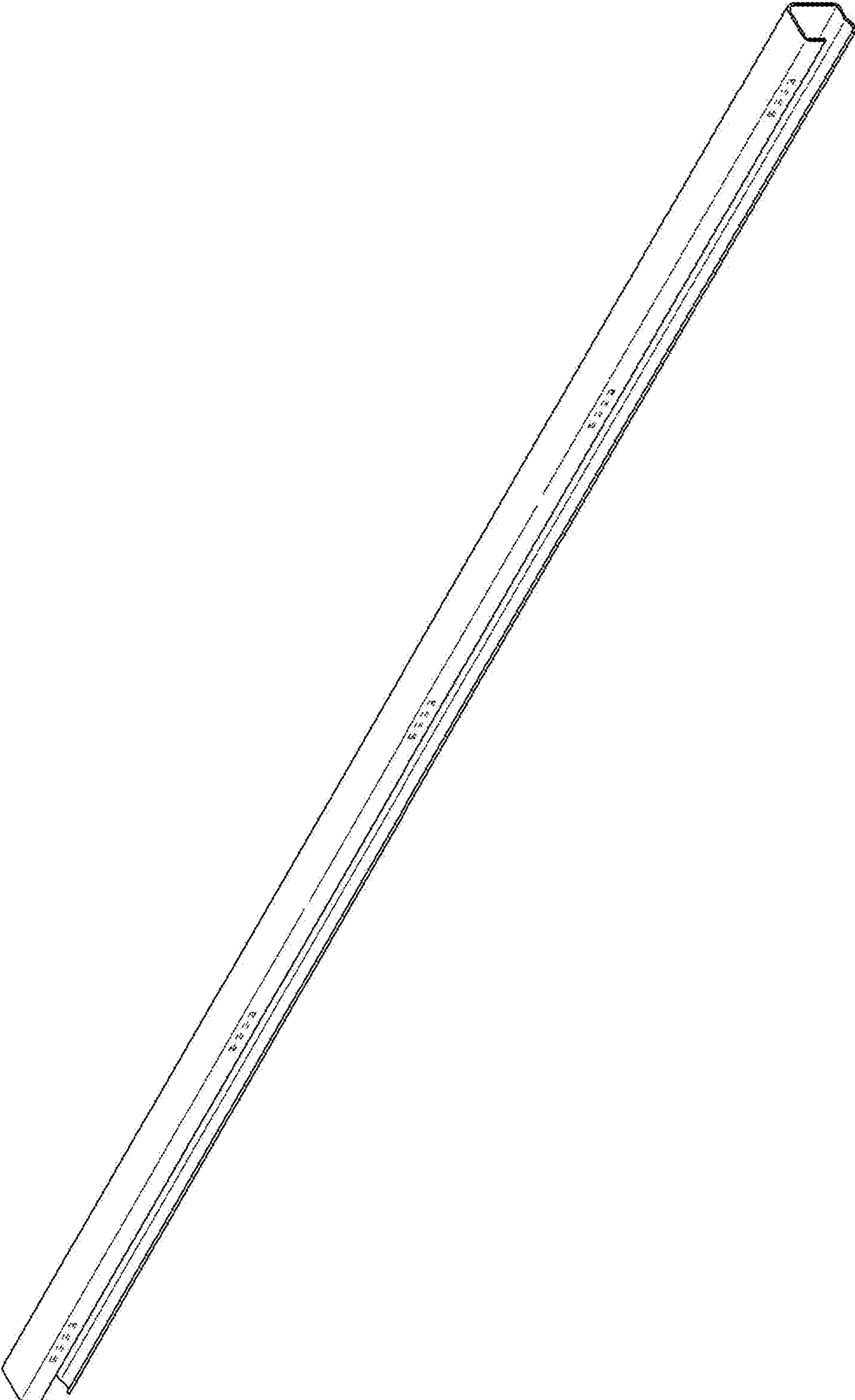

Fig.8

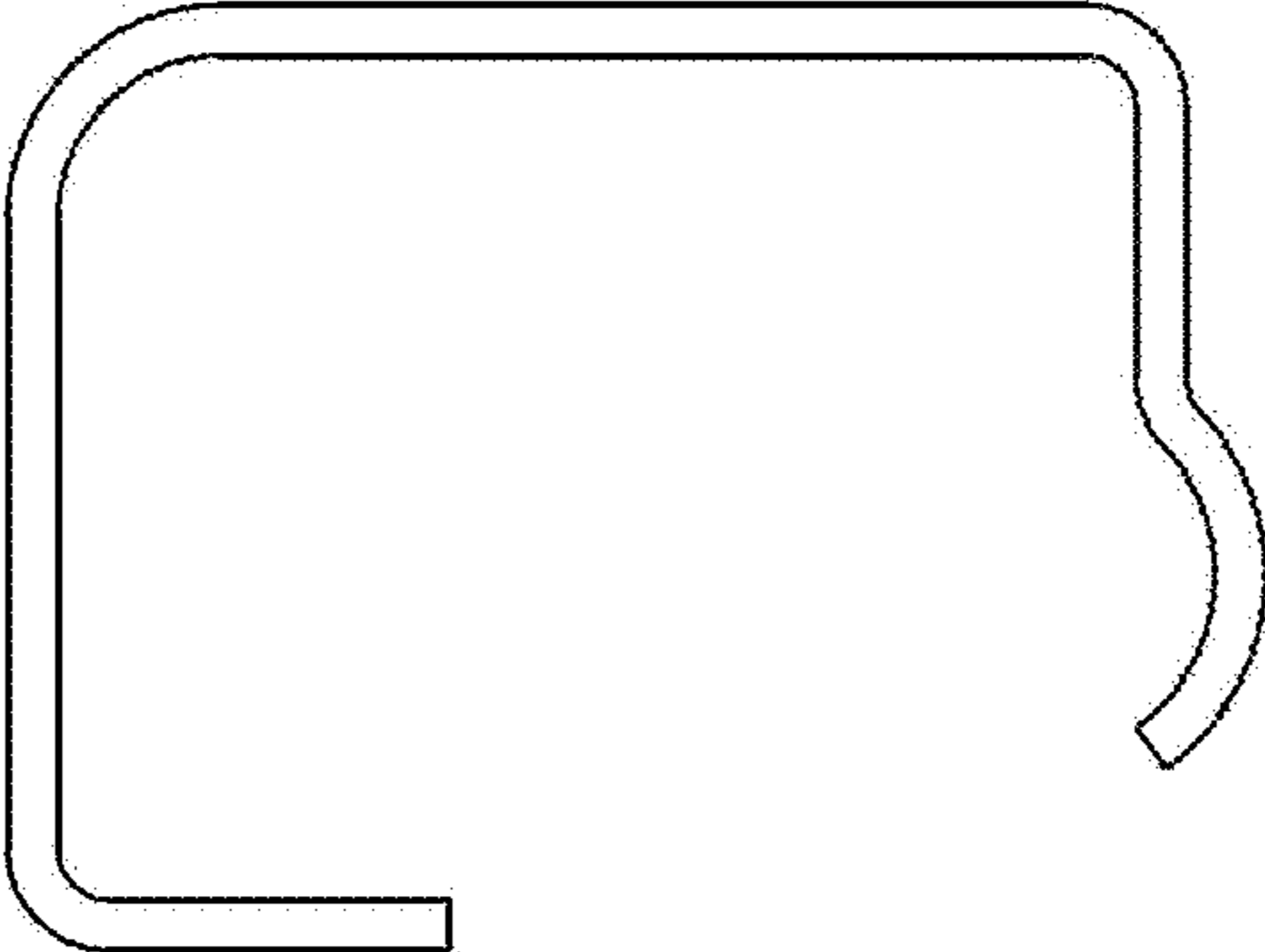

Fig. 9

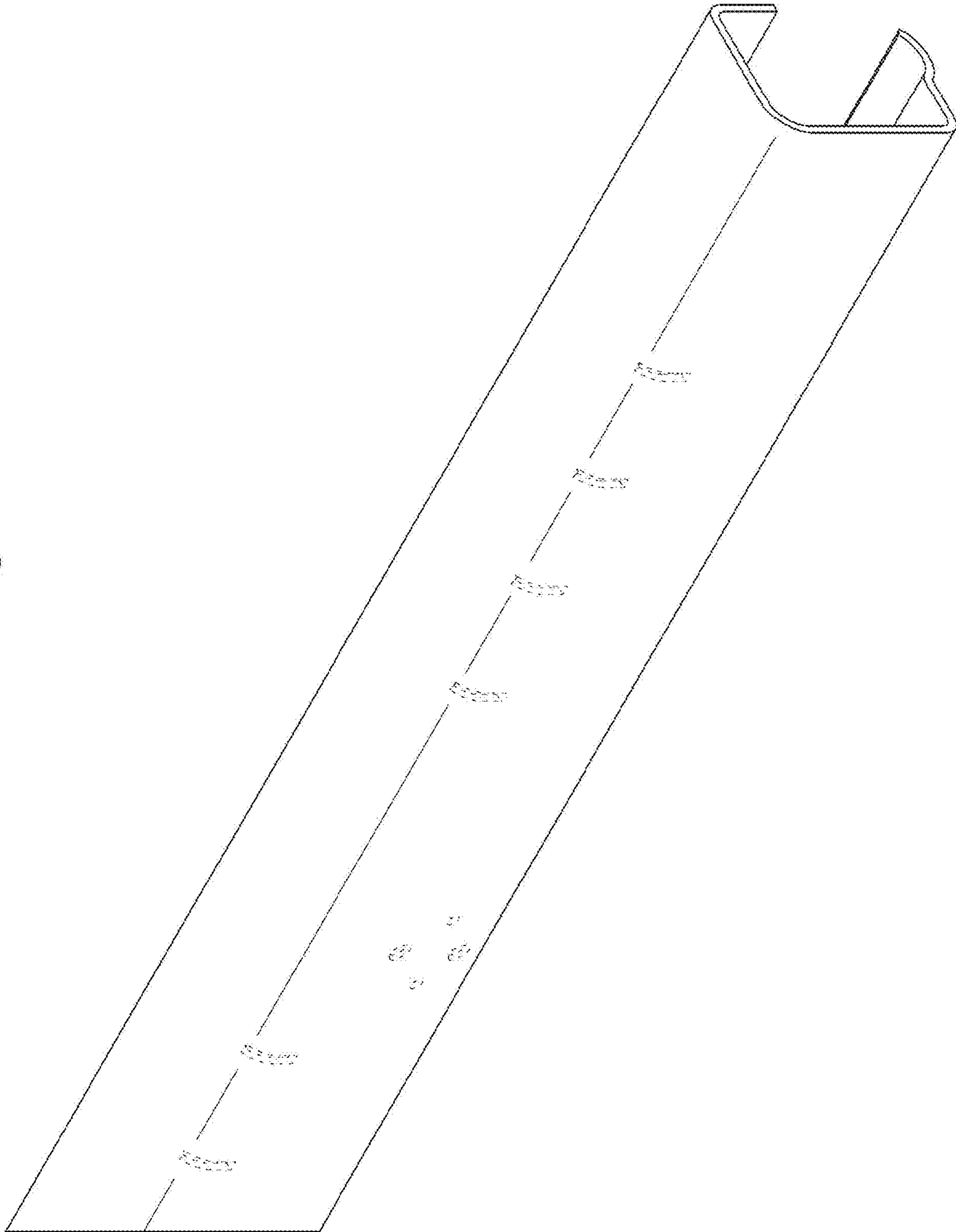

Fig. 10

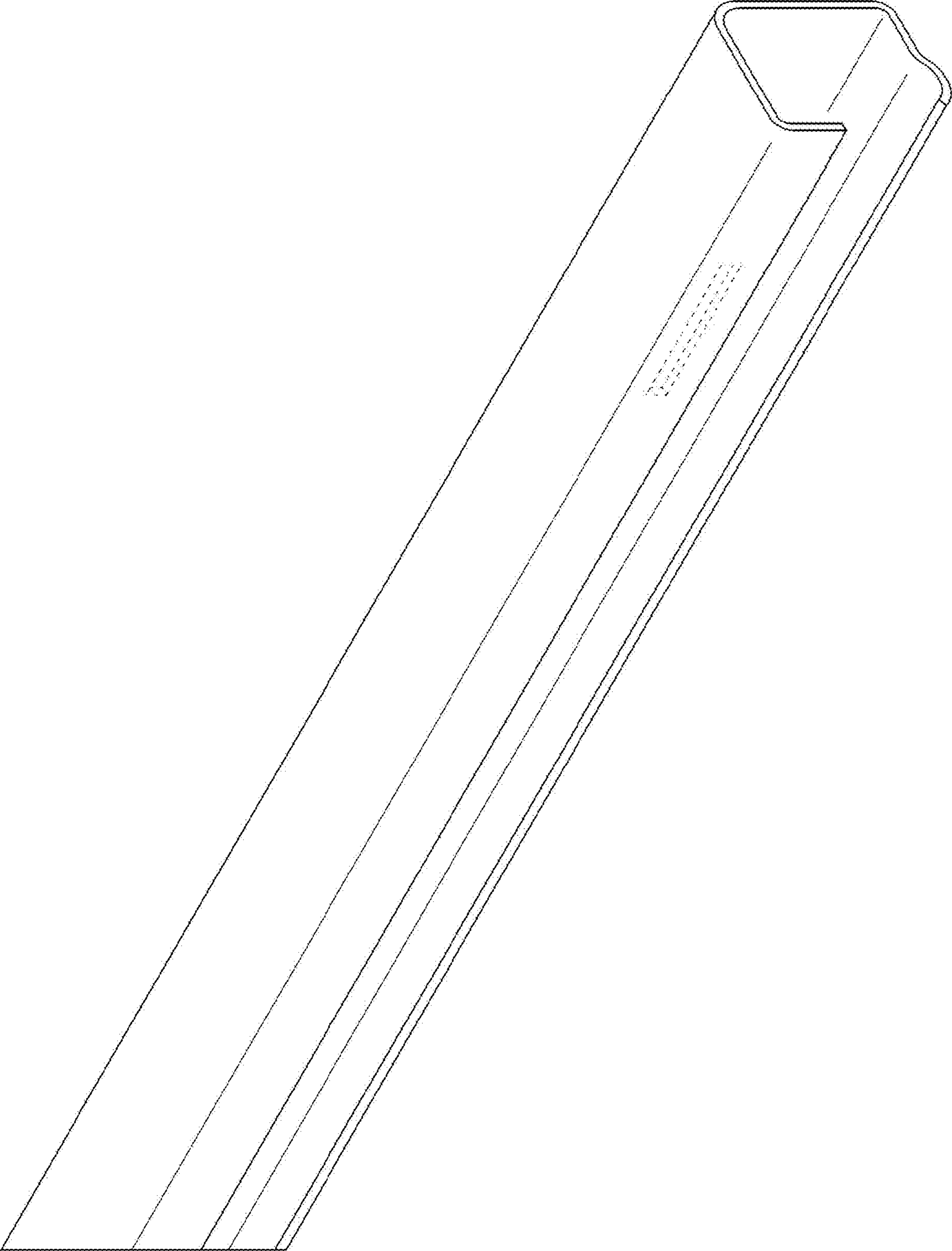

Fig. 11

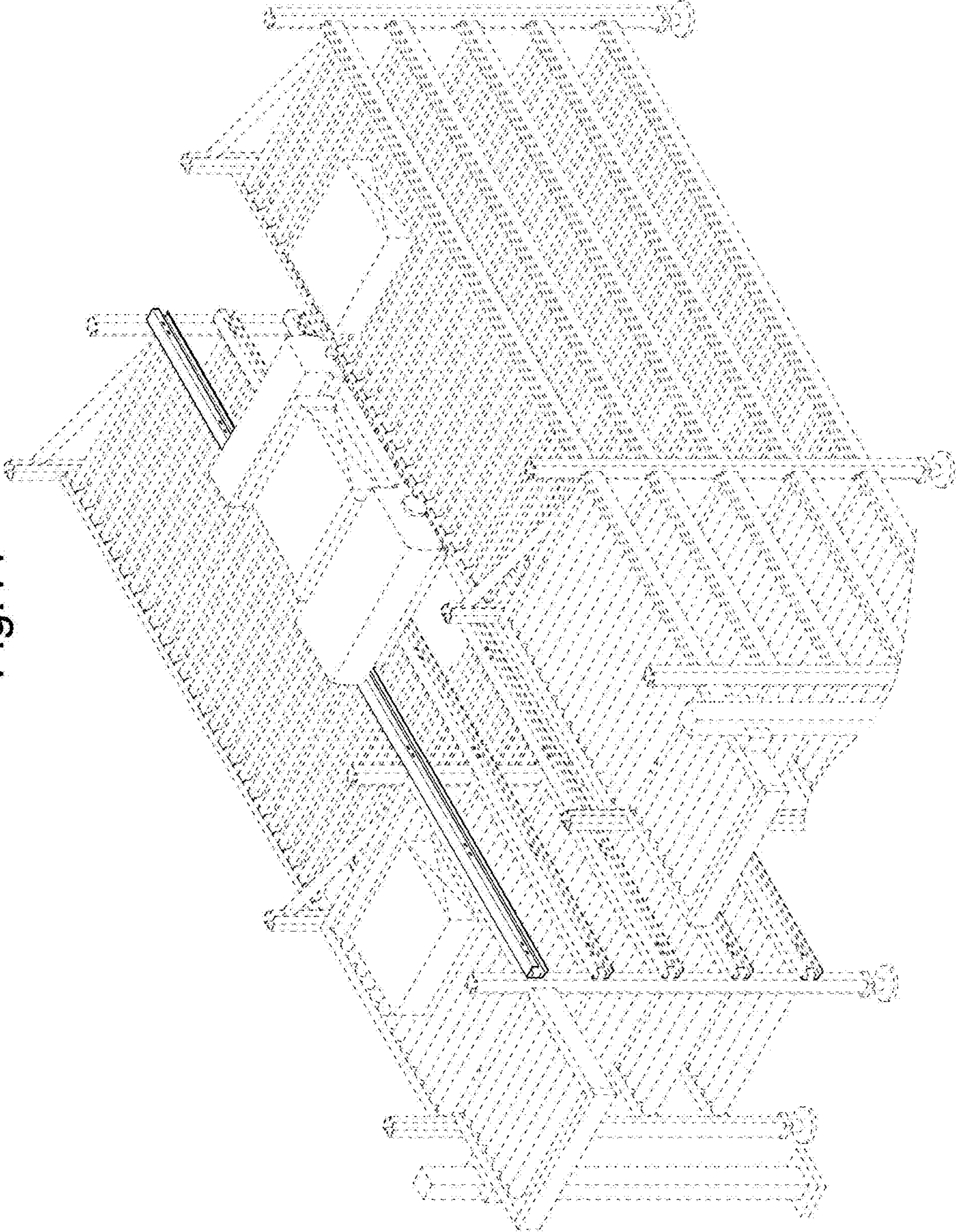

Fig. 12



Fig. 13

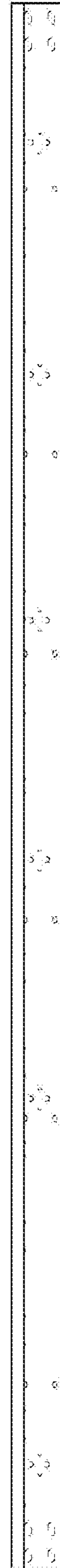

Fig. 14

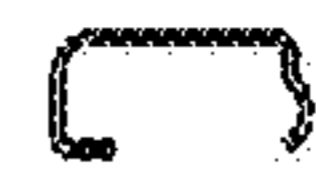

Fig. 15



Fig.16



Fig. 17

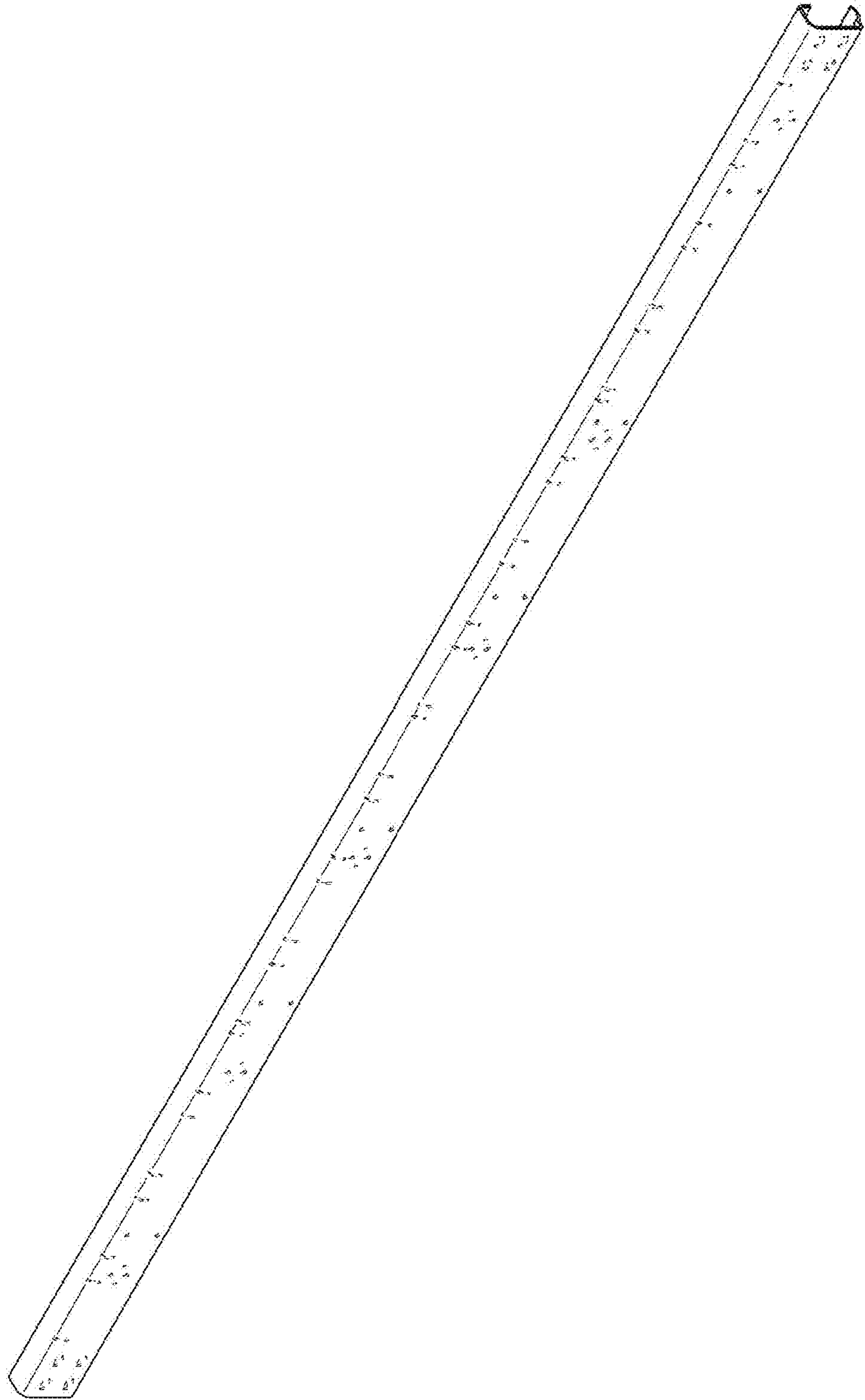

Fig.18

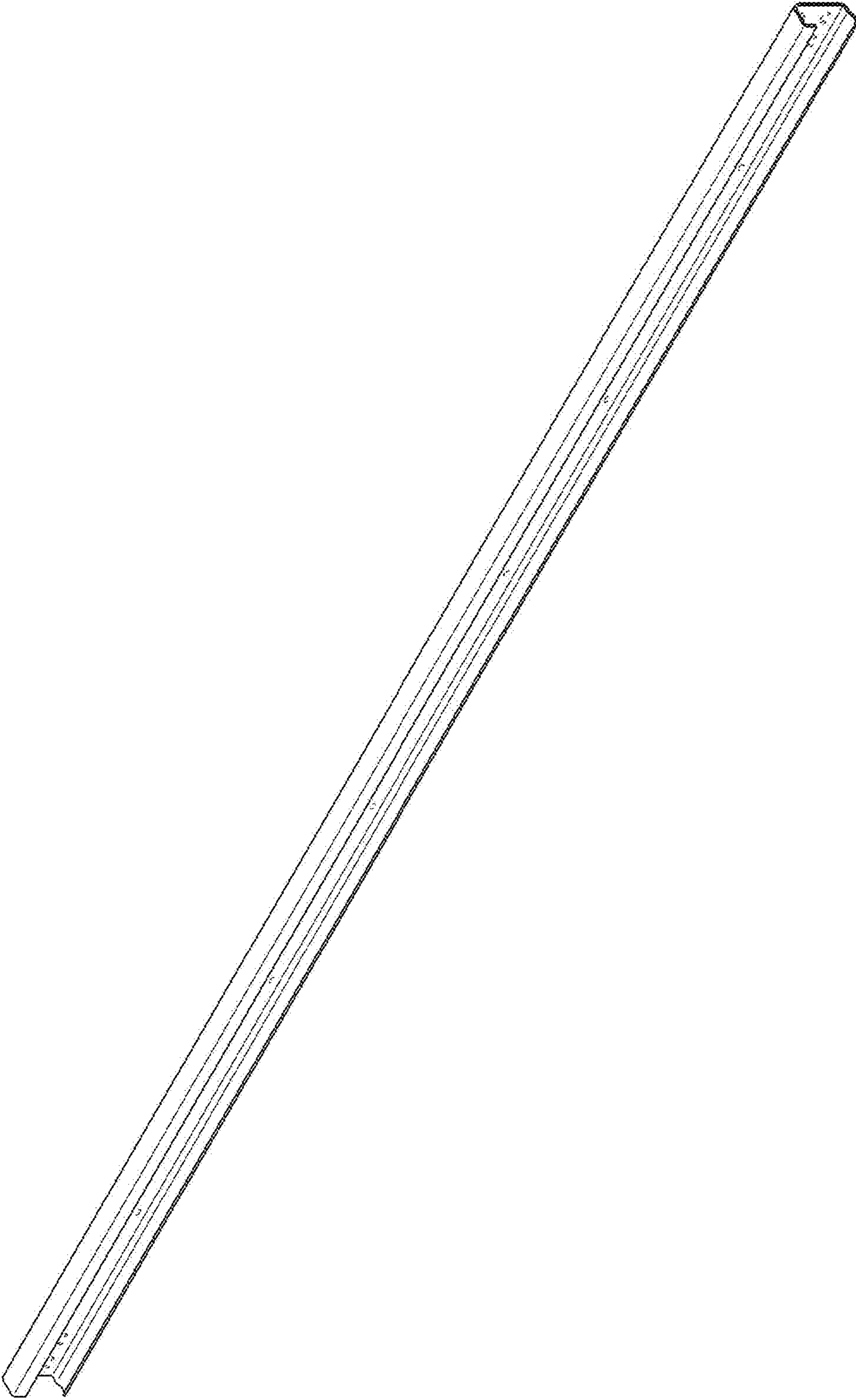

Fig. 19

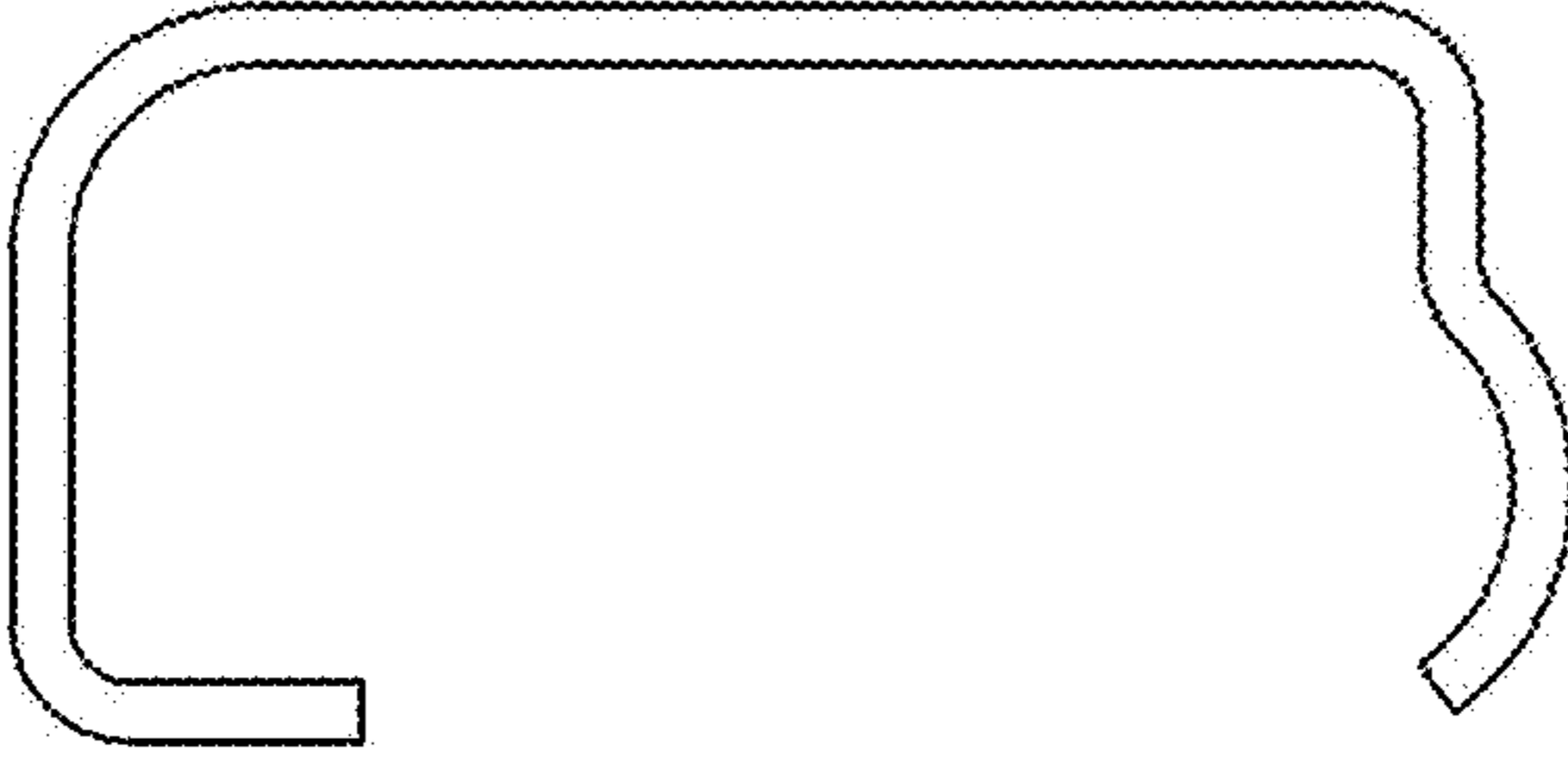

Fig.20

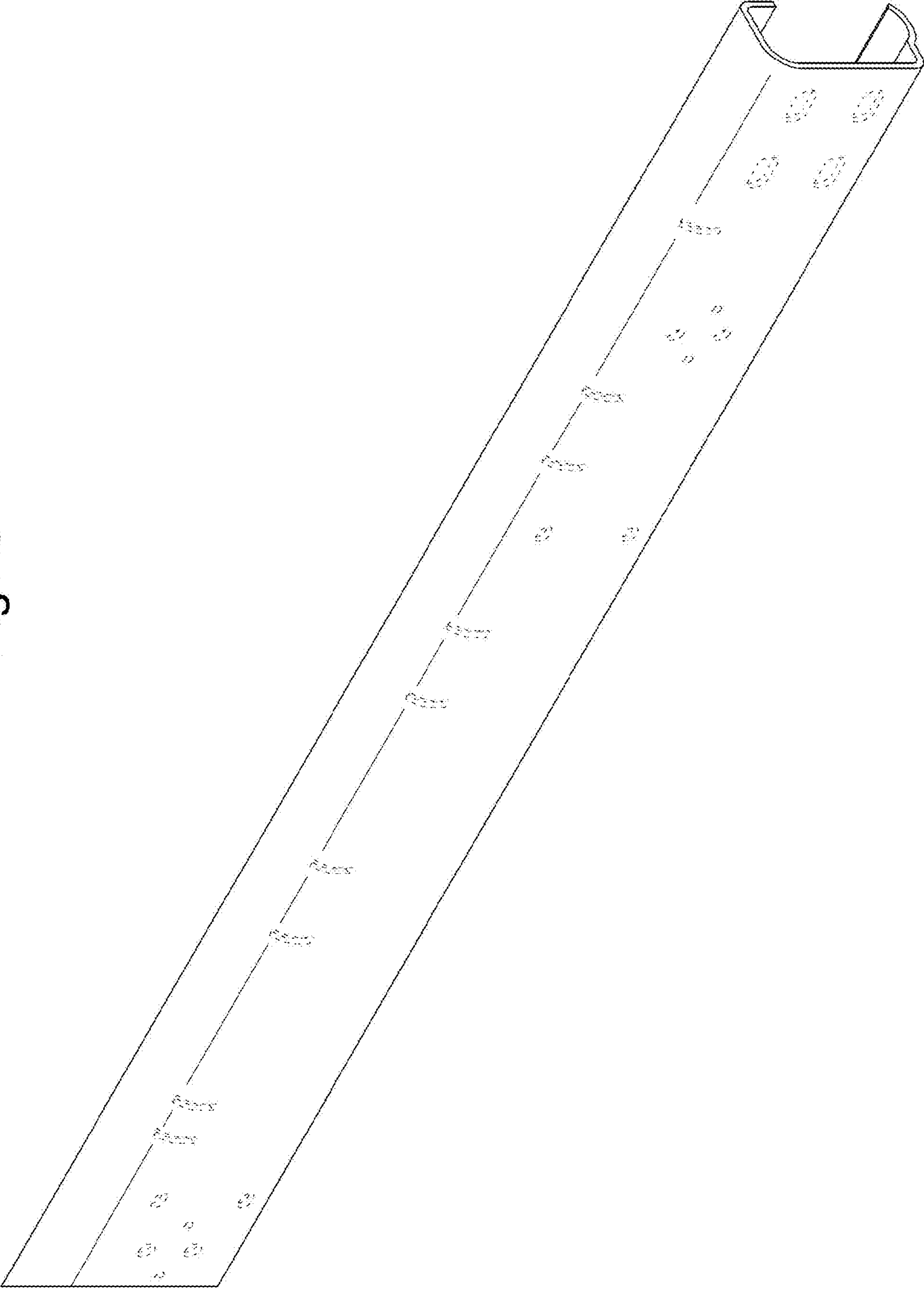
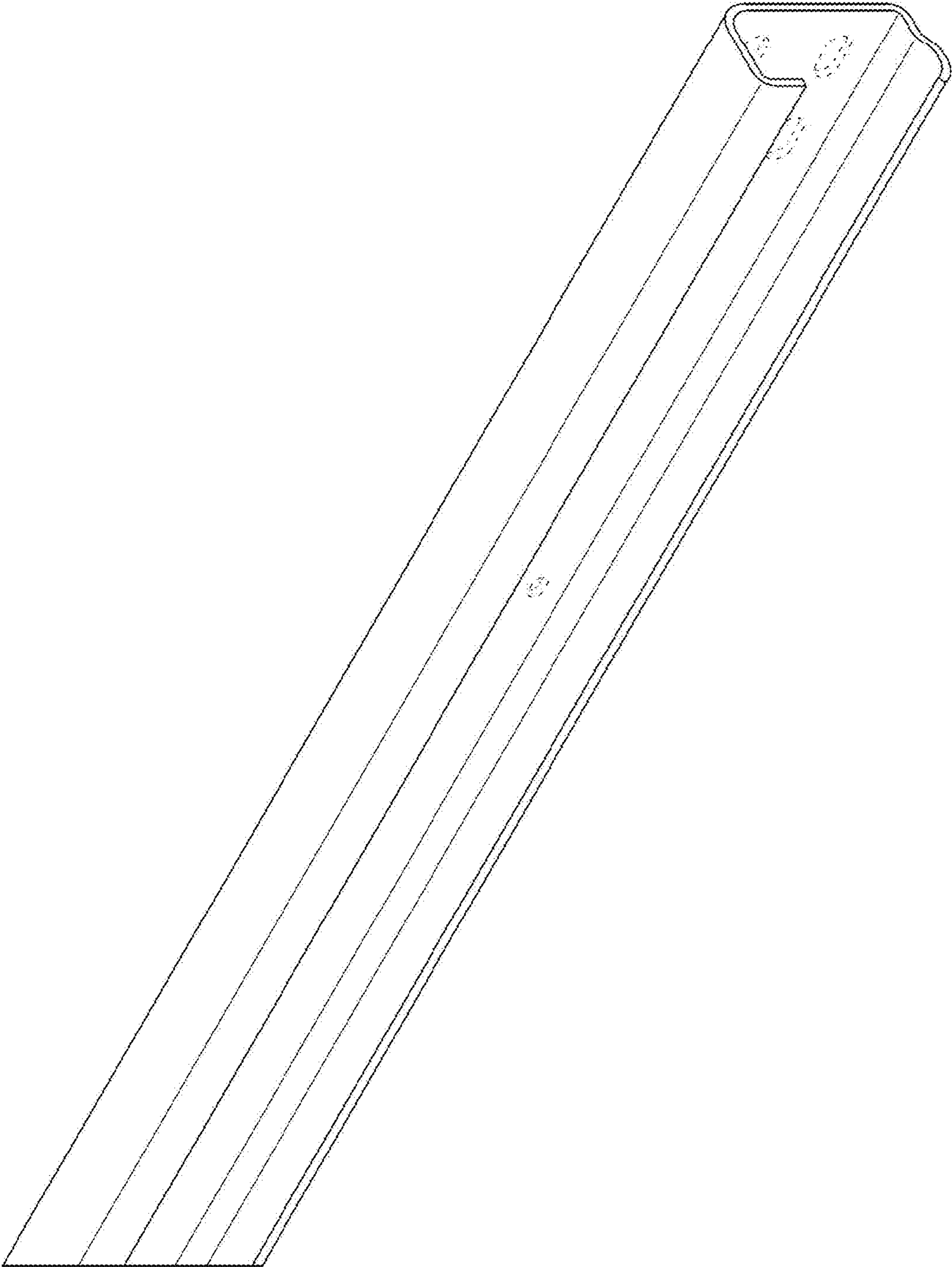

Fig. 21



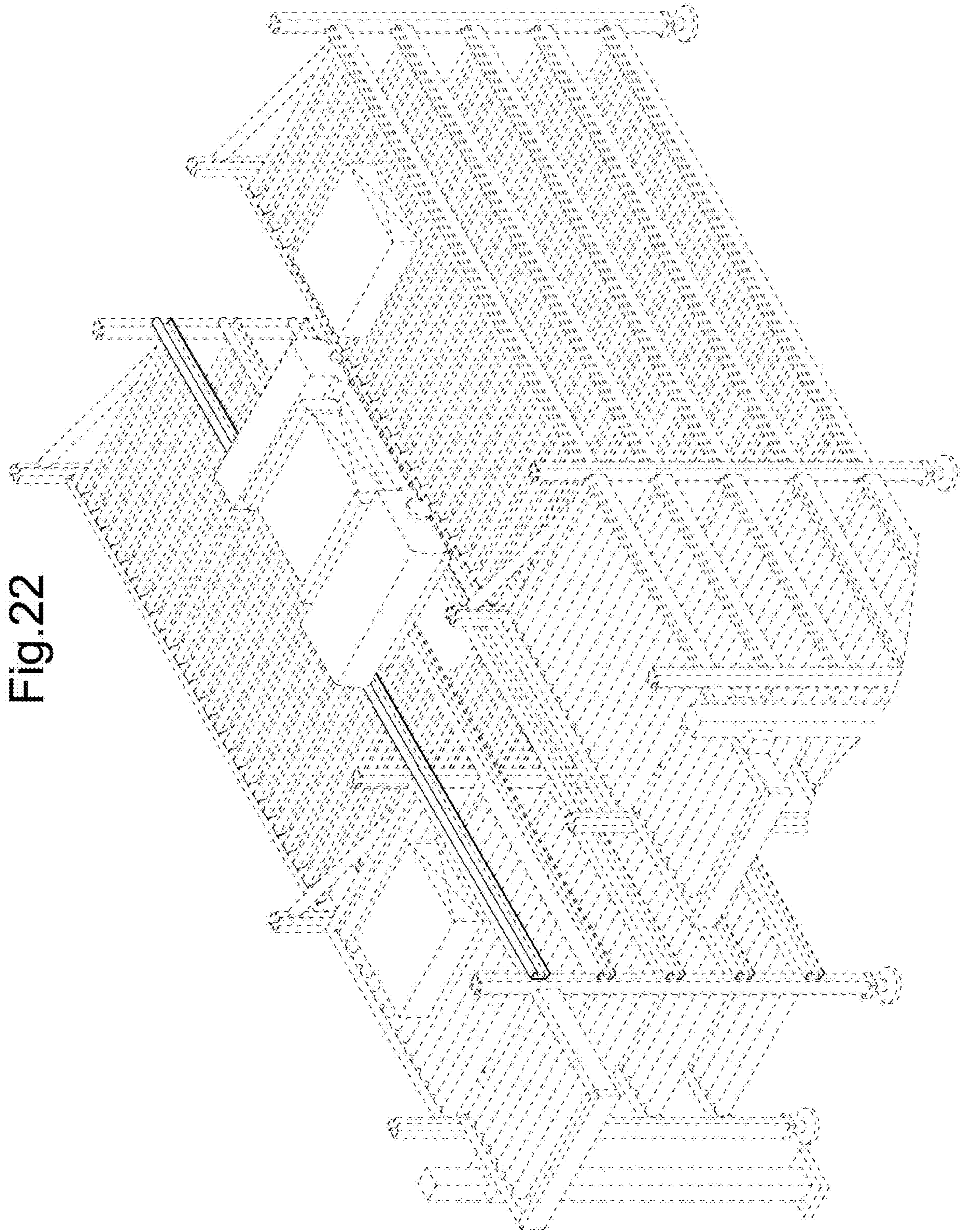

Fig.22