



US00D975921S

(12) **United States Design Patent**
Basztyk

(10) **Patent No.:** **US D975,921 S**
(45) **Date of Patent:** **** Jan. 17, 2023**

(54) **SHAVER HANDLE**
(71) Applicant: **William Alexander Basztyk**, Beaverton (CA)
(72) Inventor: **William Alexander Basztyk**, Beaverton (CA)

5,129,157 A * 7/1992 Wood B26B 21/522
30/526
10,335,966 B2 * 7/2019 Julemont B26B 19/143
D875,314 S * 2/2020 Makabi D28/48
D903,944 S * 12/2020 Basztyk D28/48
2011/0016722 A1 * 1/2011 Stark B26B 19/00
30/45

(**) Term: **15 Years**

* cited by examiner

(21) Appl. No.: **29/755,622**

Primary Examiner — Jennifer Rivard

(22) Filed: **Oct. 21, 2020**

(57) **CLAIM**

Related U.S. Application Data

The ornamental design for a shaver handle, as shown and described.

(63) Continuation-in-part of application No. 29/694,399, filed on Jun. 10, 2019, now Pat. No. Des. 903,944.

DESCRIPTION

(30) **Foreign Application Priority Data**

Dec. 10, 2018 (CA) CA 185156

(51) **LOC (14) Cl.** **28-03**

(52) **U.S. Cl.**
USPC **D28/48**

(58) **Field of Classification Search**
USPC D28/46–48
CPC B26B 21/22–227; B26B 21/14; B26B 21/18–20; B26B 21/52–522
See application file for complete search history.

FIG. 1 is a top perspective view showing my design;
FIG. 2 is a bottom perspective view thereof;
FIG. 3 is a front side view thereof, the rear side view being identical thereto;
FIG. 4 is a right side view thereof, the left side view being identical thereto;
FIG. 5 is a top plan view thereof;
FIG. 6 is a bottom plan view thereof; and,
FIG. 7 is a reduced top perspective view thereof, wherein the razor blade and the razor cartridge are attached onto the shaver handle.

(56) **References Cited**

U.S. PATENT DOCUMENTS

1,774,596 A * 9/1930 Friedman B26B 21/24
30/47
D252,528 S * 7/1979 Harshberger D28/46

The broken lines showing the razor blade and the razor cartridge in FIG. 7 illustrate environmental structure. The remaining broken lines illustrate portions of the shaver handle. None of the broken line disclosure forms part of the claimed design.

1 Claim, 7 Drawing Sheets

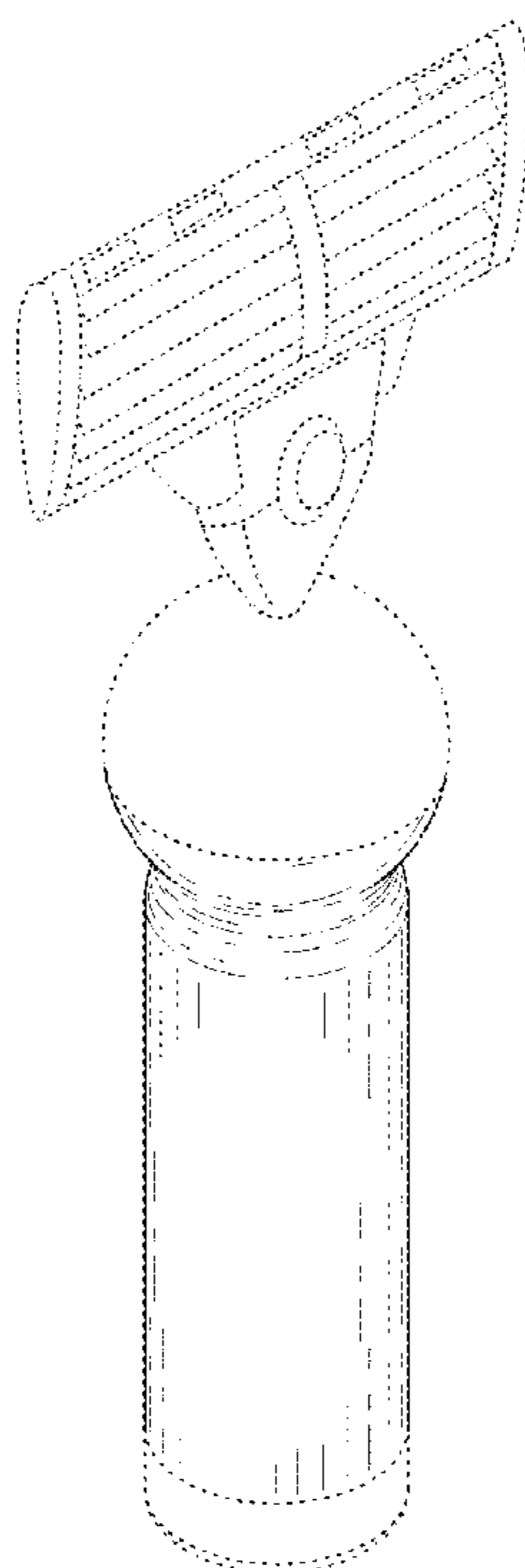

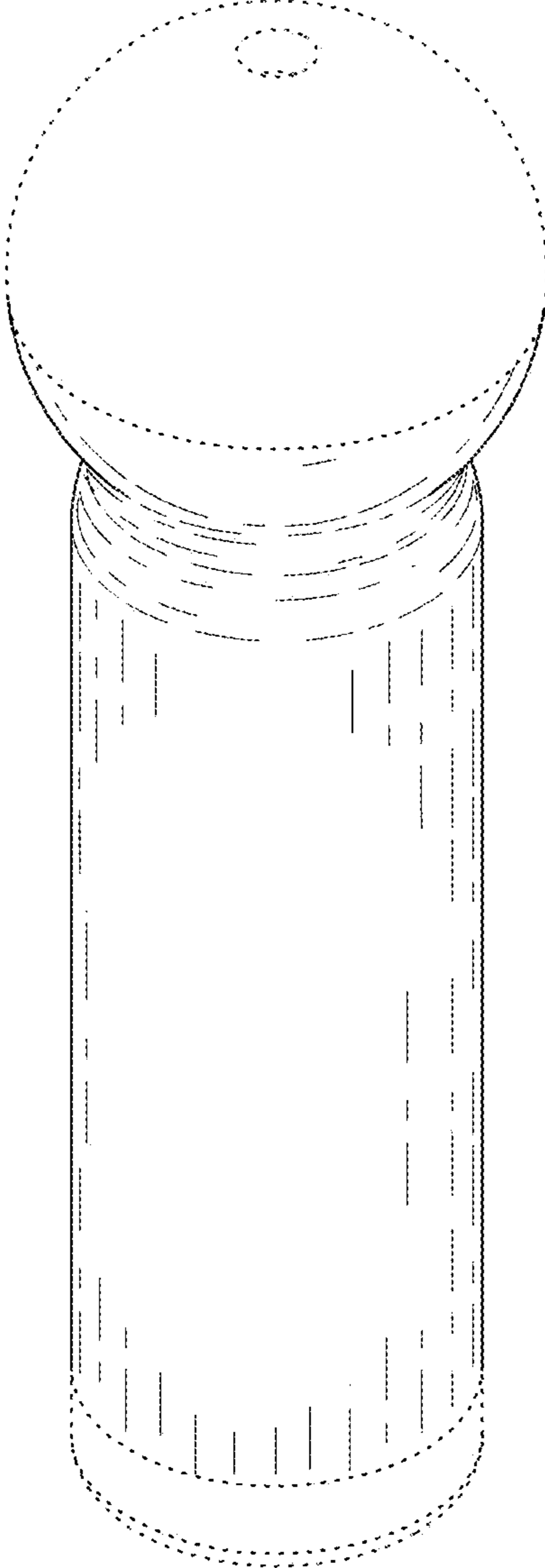

FIG. 1

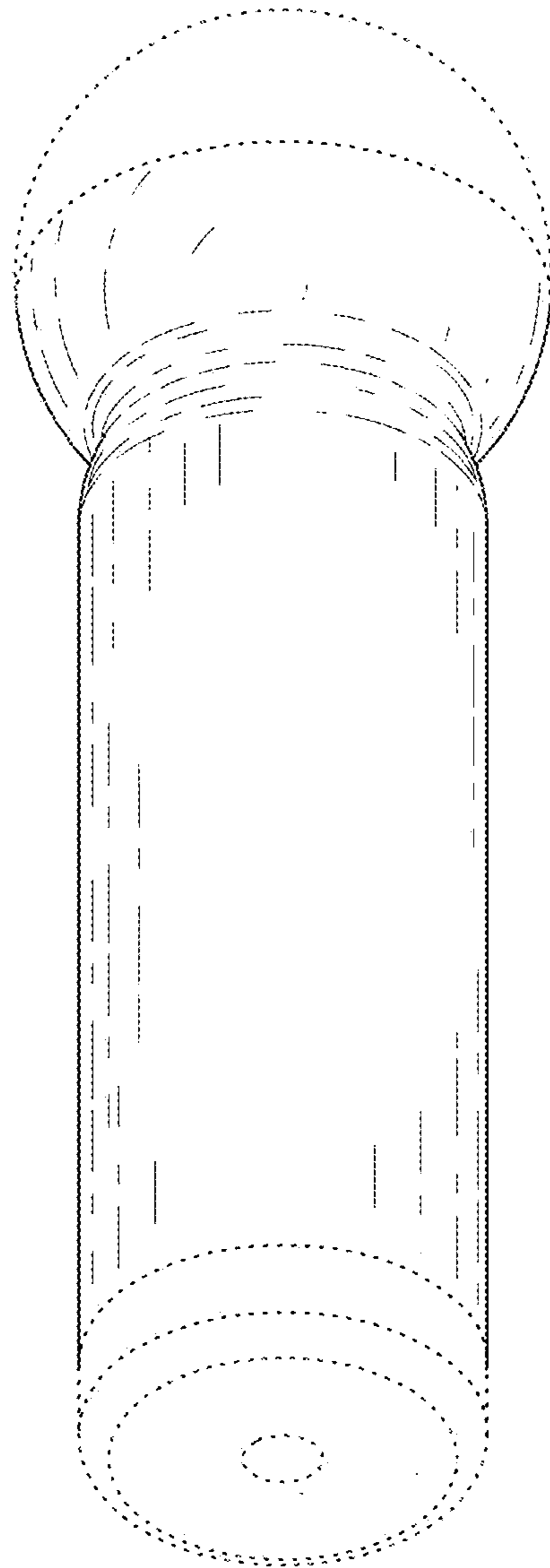

FIG. 2

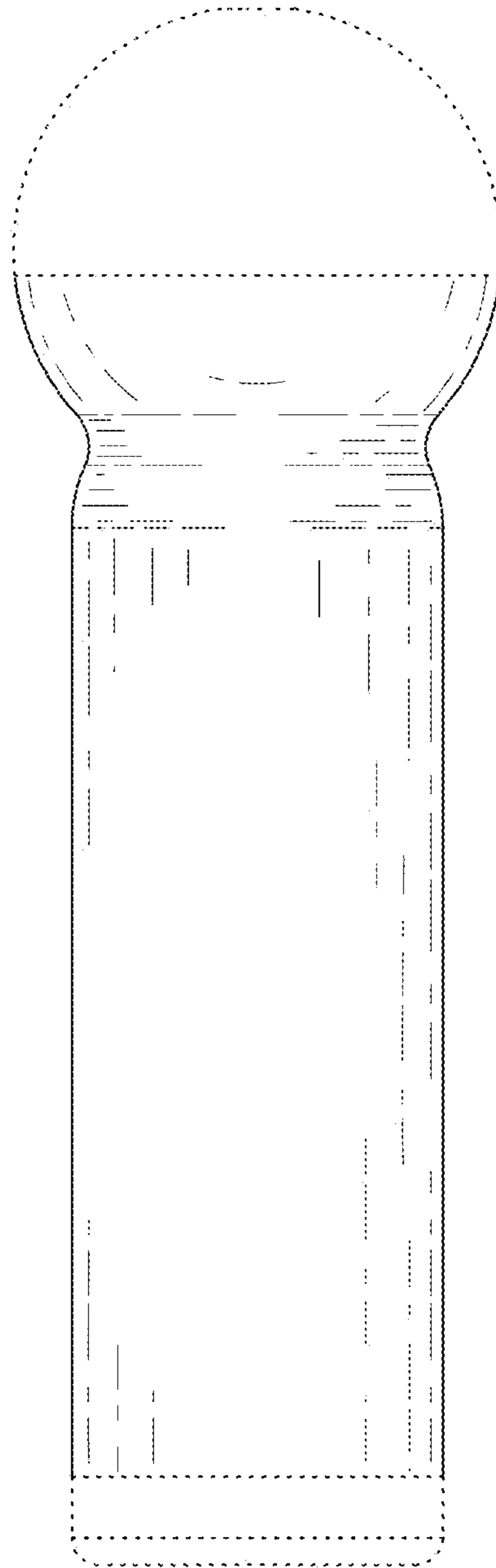

FIG. 3



FIG. 4

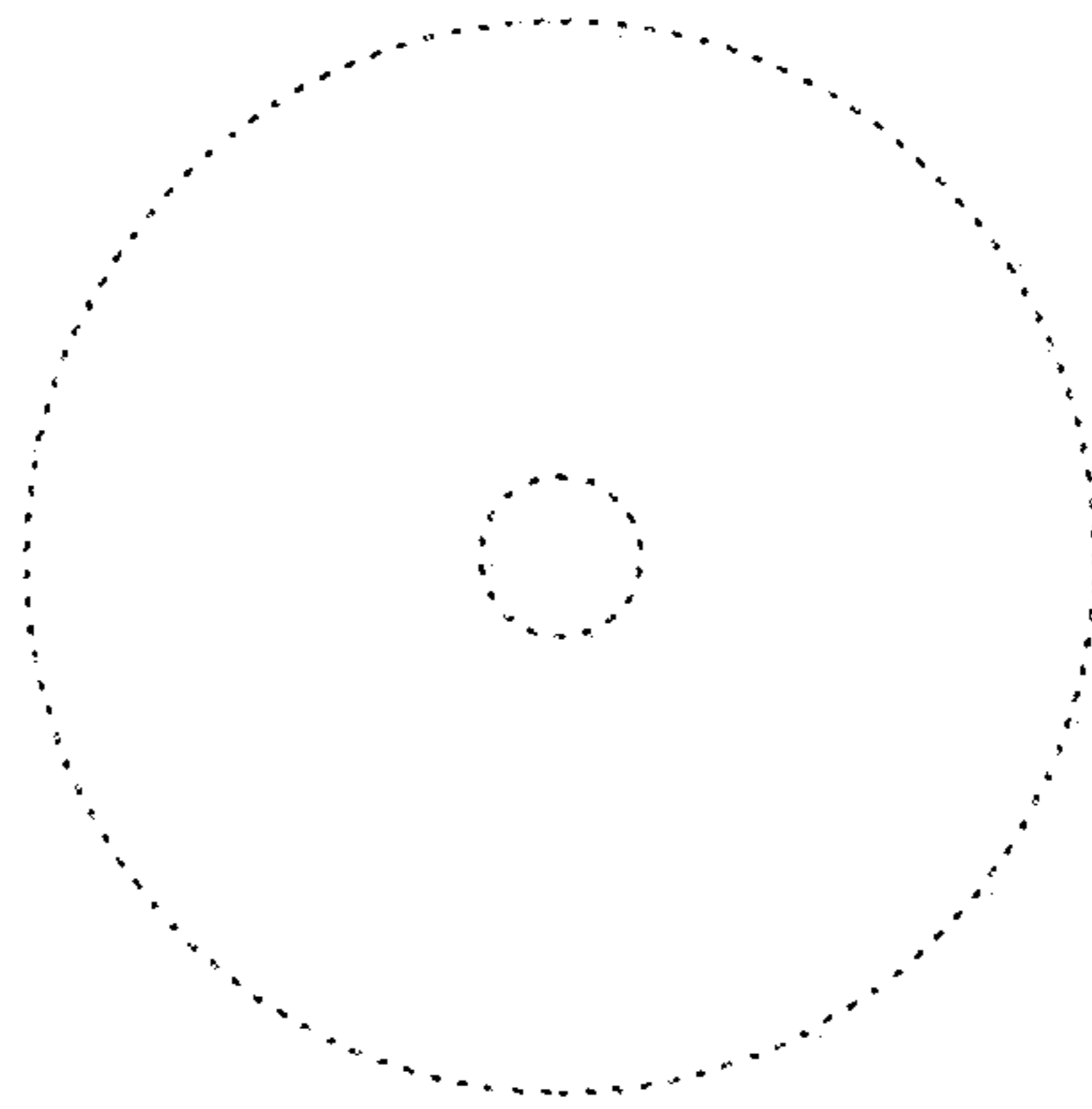

FIG. 5

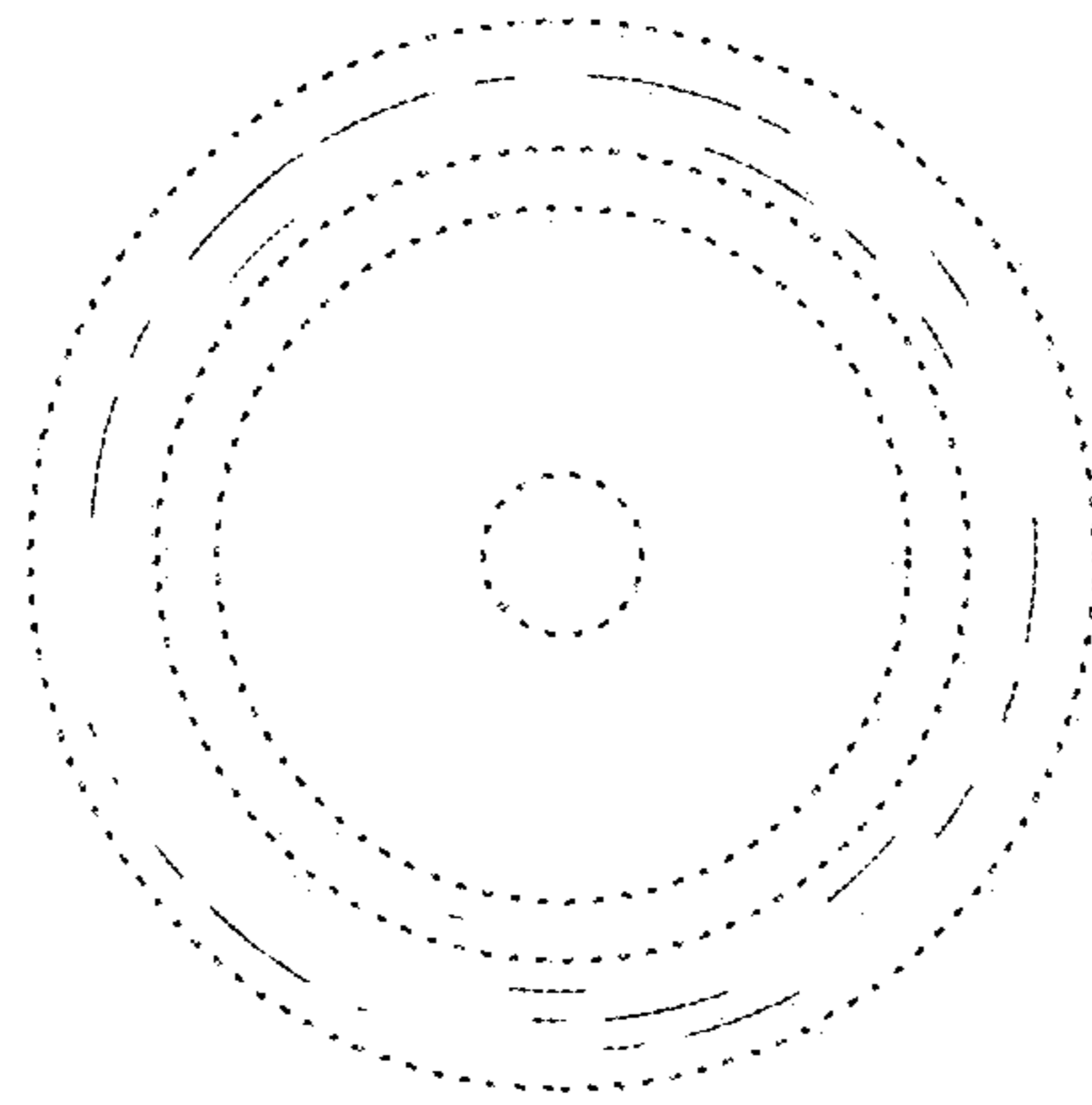

FIG. 6

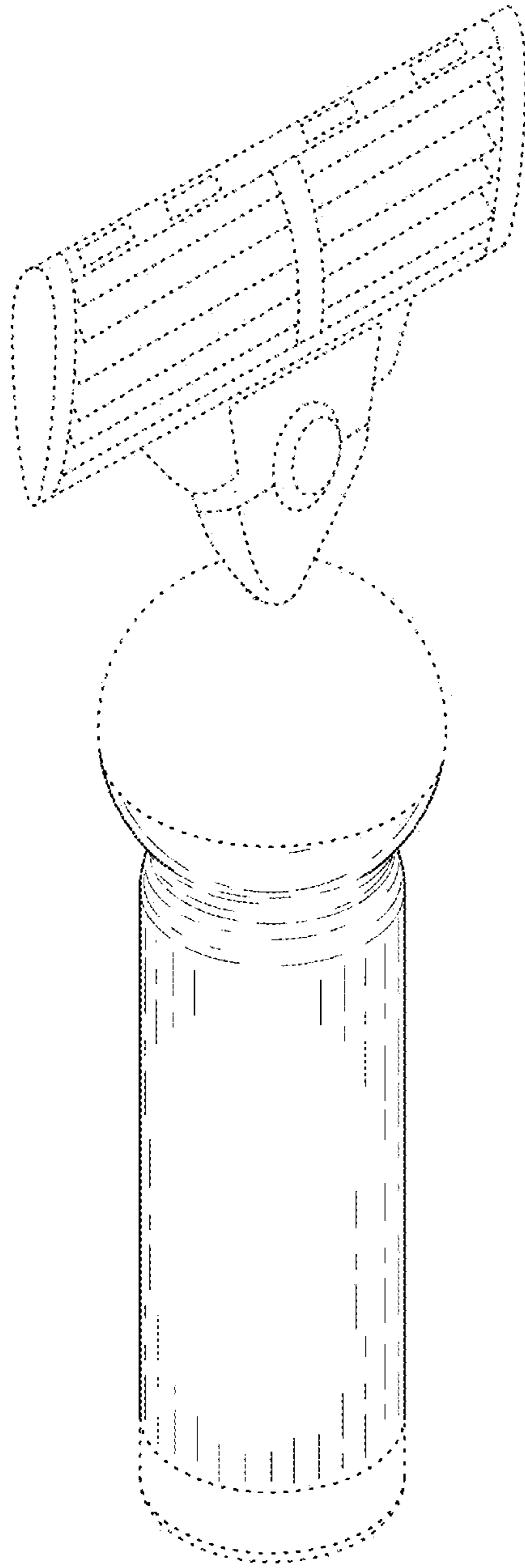

FIG. 7