

US00D975858S

(12) **United States Design Patent**
Jiang

(10) **Patent No.:** **US D975,858 S**

(45) **Date of Patent:** **** Jan. 17, 2023**

(54) **VIBRATOR**

(71) Applicant: **Dongguan Youjie Electronic Co., Ltd.**,
Dongguan (CN)

(72) Inventor: **Yongyou Jiang**, Dongguan (CN)

(73) Assignee: **DONGGUAN YOUJIE ELECTRONIC CO., LTD.**, Dongguan (CN)

(**) Term: **15 Years**

(21) Appl. No.: **29/754,132**

(22) Filed: **Oct. 7, 2020**

(51) **LOC (14) Cl.** **28-03**

(52) **U.S. Cl.**
USPC **D24/215**

(58) **Field of Classification Search**
USPC D24/215, 200, 211, 212, 213, 214, 133,
D24/107, 231, 184, 141; D3/207, 203.2,
D3/203.3; D14/480.5
CPC A61H 19/00; A61H 19/30; A61H 19/32;
A61H 19/34; A61H 19/40; A61H 19/44;
A61H 19/50; A61H 21/00; A61H 23/00;
A61H 7/00; A61H 7/003; A61H 7/004;
A61H 9/00; A61H 2205/087

See application file for complete search history.

(56) **References Cited**

U.S. PATENT DOCUMENTS

D426,311 S *	6/2000	Horowitz	D27/101
D506,550 S *	6/2005	Greenberg	D24/146
D536,700 S *	2/2007	Landau	D14/480.5
D547,878 S *	7/2007	Lai	D24/214
D585,997 S *	2/2009	Adam	D24/107
D592,313 S *	5/2009	Levine	D24/214
D606,206 S *	12/2009	Nan	D24/215
D648,862 S *	11/2011	Yen	D24/215

D666,732 S *	9/2012	Caggiano	D24/214
D685,105 S *	6/2013	Marshall	D24/215
D741,479 S *	10/2015	Agrawal	D24/141
D821,600 S *	6/2018	Chang	D24/215
D895,828 S *	9/2020	Marshall	D24/215
D924,421 S *	7/2021	Luo	D24/215
2013/0253386 A1 *	9/2013	Nan	A61H 23/0263 29/428
2020/0155411 A1 *	5/2020	Lee	B06B 1/045

OTHER PUBLICATIONS

Rosy Gold—Bullet Vibrator. Date: Nov. 10, 2019. [online]. [Site visited Jun. 23, 2022]. Available from Internet URL: <https://www.amazon.co.uk/dp/B07YWVTCPK/?th=1> (Year: 2019).*

Rechargeable bullet. Date: May 9, 2018. [online]. [Site visited Jun. 23, 2022]. Available from Internet URL: adameve.com/adult-sex-toys/vibrators/bullet-eggs/sp-all-powerful-rechageable-bullet-105268.aspx (Year: 2018).*

(Continued)

Primary Examiner — Susan Bennett Hattan
Assistant Examiner — Landon Thomas Cassell
(74) *Attorney, Agent, or Firm* — Leong C. Lei

(57) **CLAIM**

The ornamental design for a vibrator, as shown and described.

DESCRIPTION

FIG. 1 is a perspective view of a vibrator showing my present design;
FIG. 2 is a front view thereof;
FIG. 3 is a rear view thereof;
FIG. 4 is a left side view thereof;
FIG. 5 is a right side view thereof;
FIG. 6 is a top view thereof; and,
FIG. 7 is a bottom view thereof.

1 Claim, 7 Drawing Sheets

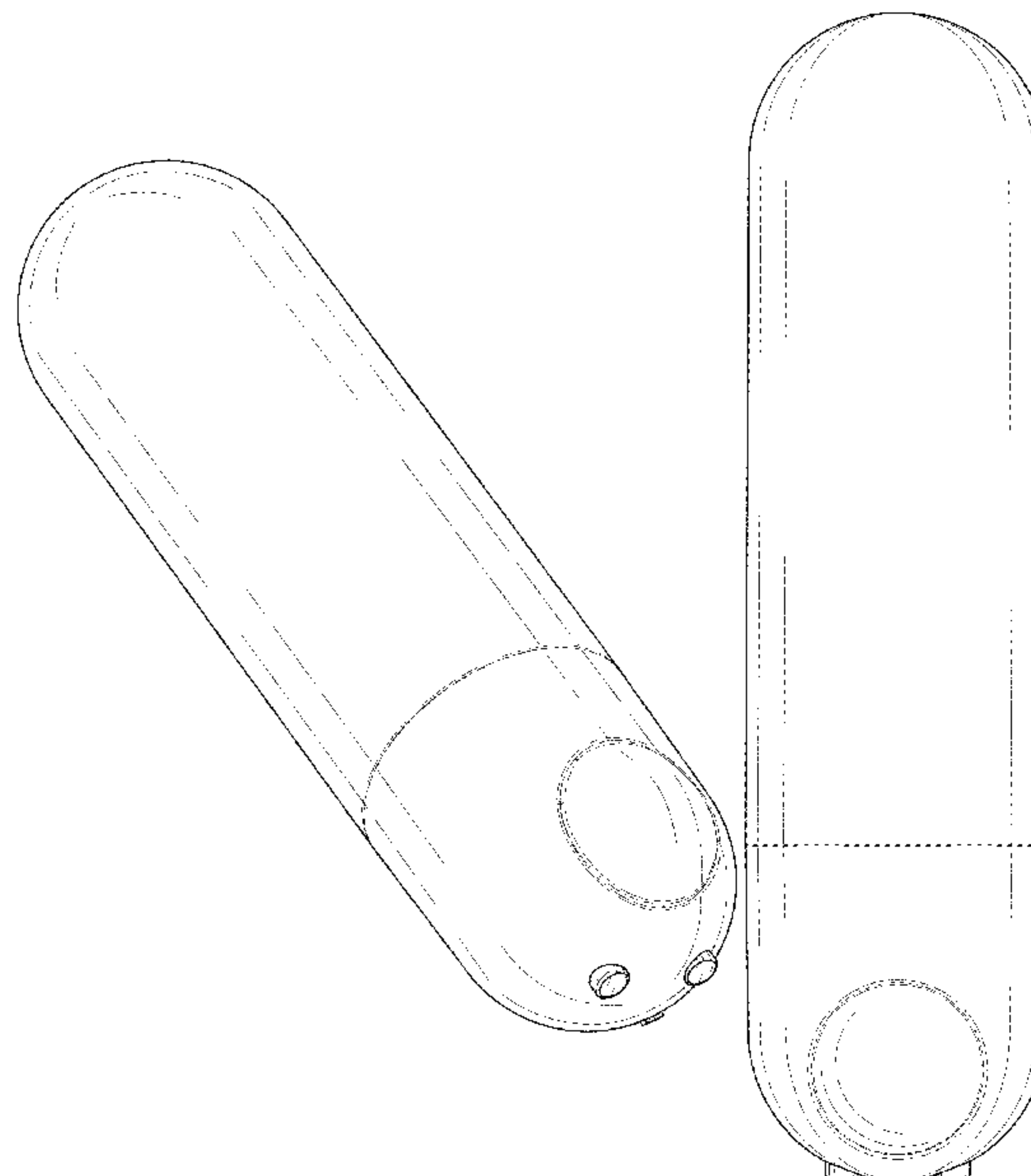

(56)

References Cited

OTHER PUBLICATIONS

Jimmyjane—mini chroma. Date: not listed. [online]. [Site visited Jun. 29, 2022]. Available from Internet URL: <https://jimmyjane.com/products/mini-chroma?variant=39374963474518> (Year: NA).*

Vibrators. (Design—© Questel) orbit.com. [Online PDF compilation of references] 52 pgs. Print Dates Range Apr. 27, 2016-Apr. 6, 2021 [Retrieved Jul. 6] <https://www.orbit.com/export/UCZAH96B/pdf4/bbafb546-96d9-489d-9b10-e51d4f8fadec-195456.pdf> (Year: 2022).*

* cited by examiner

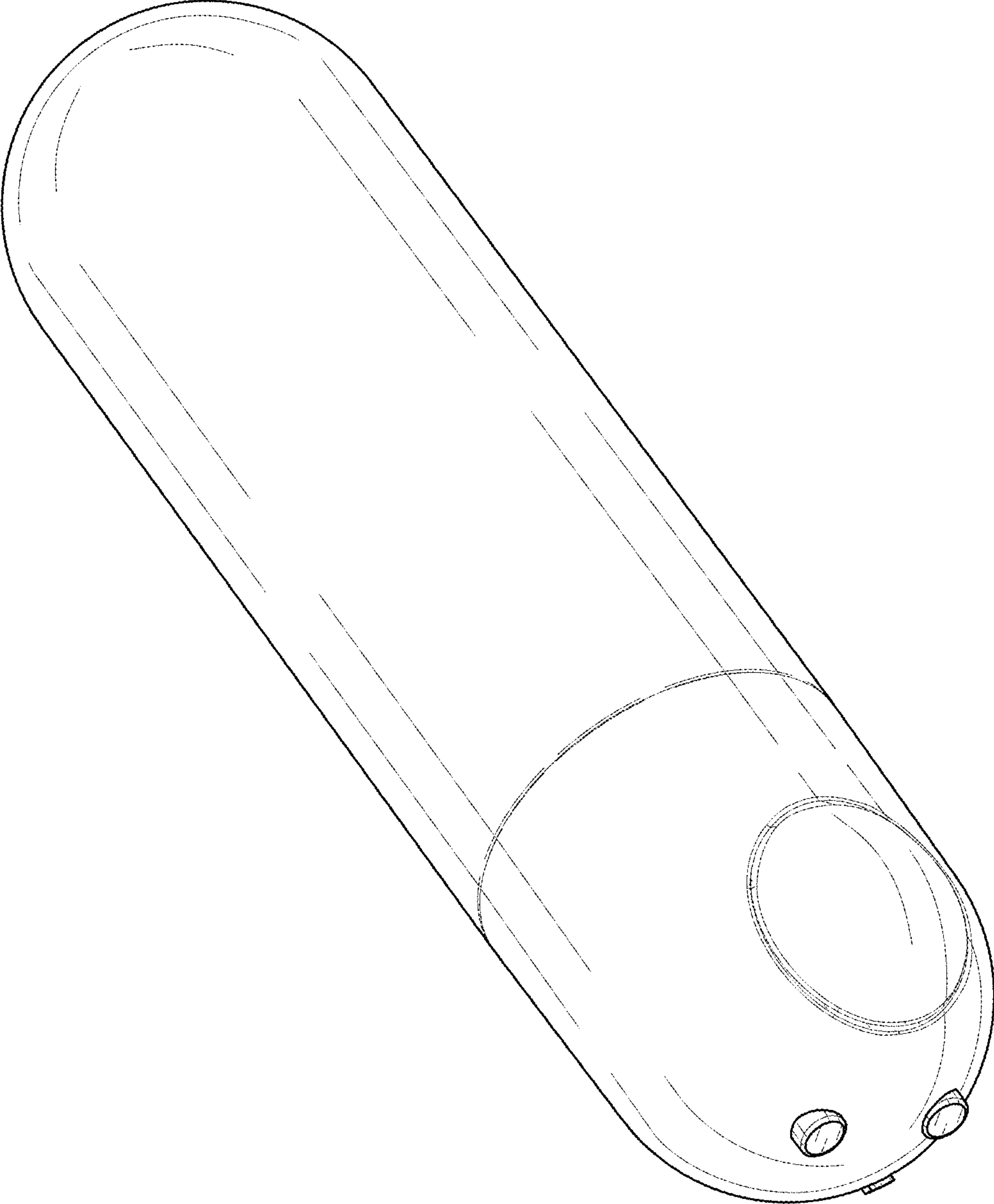

F I G . 1

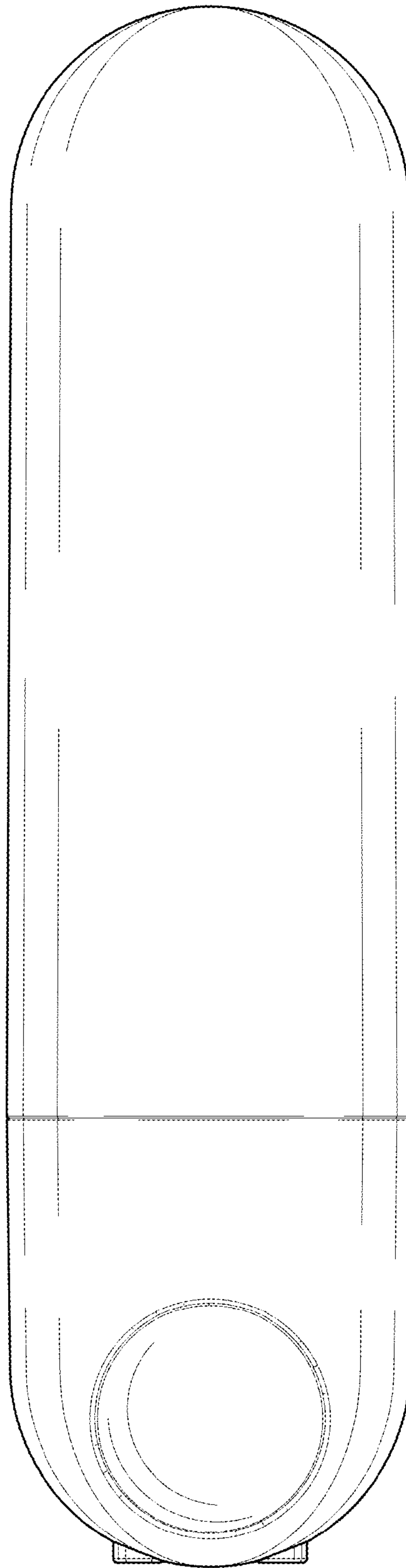
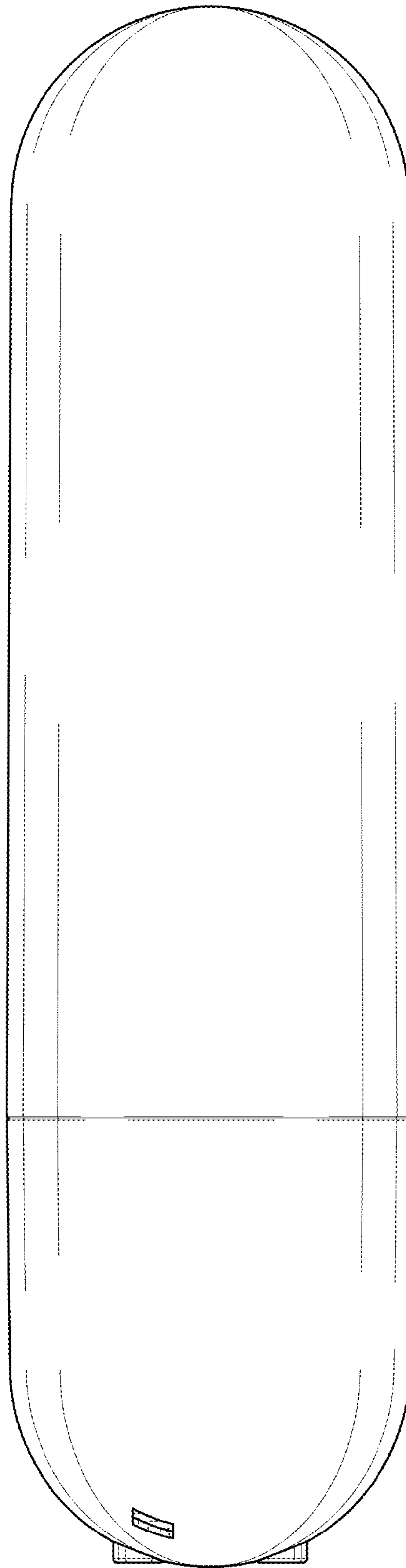
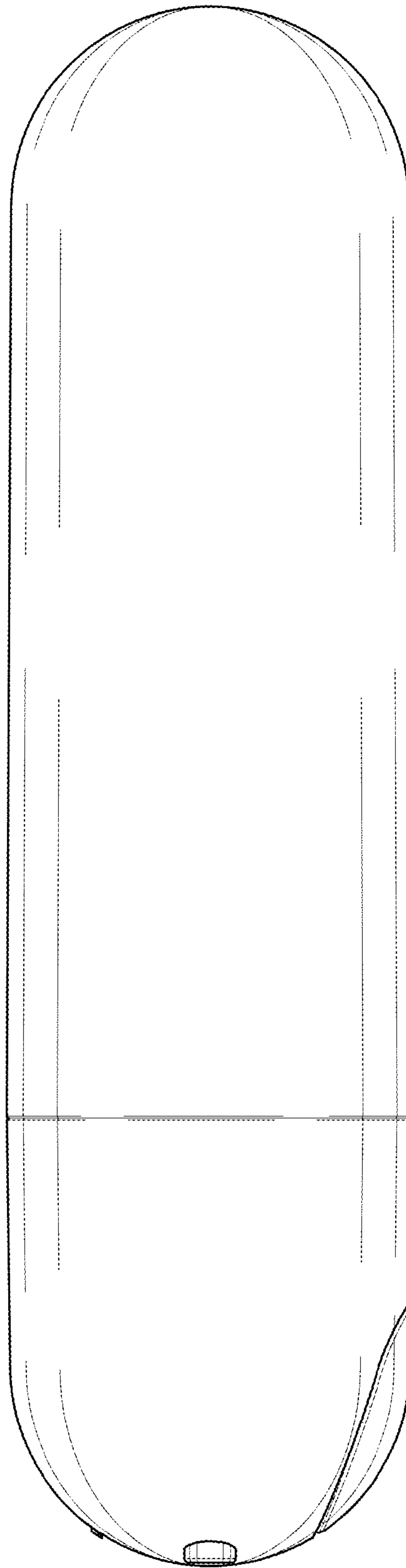

FIG. 2



F I G. 3



F I G . 4

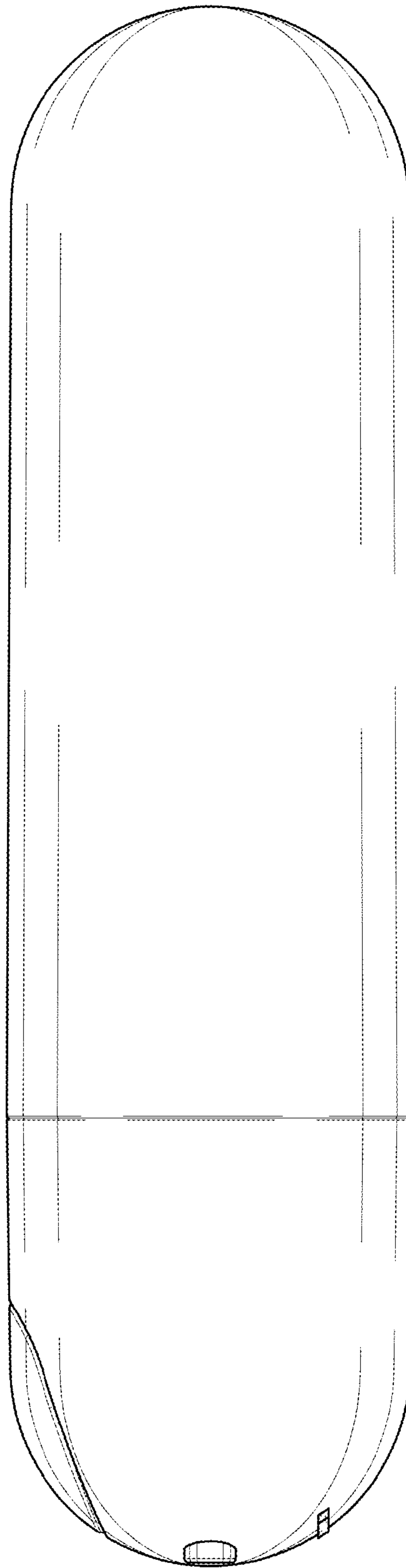

F I G. 5

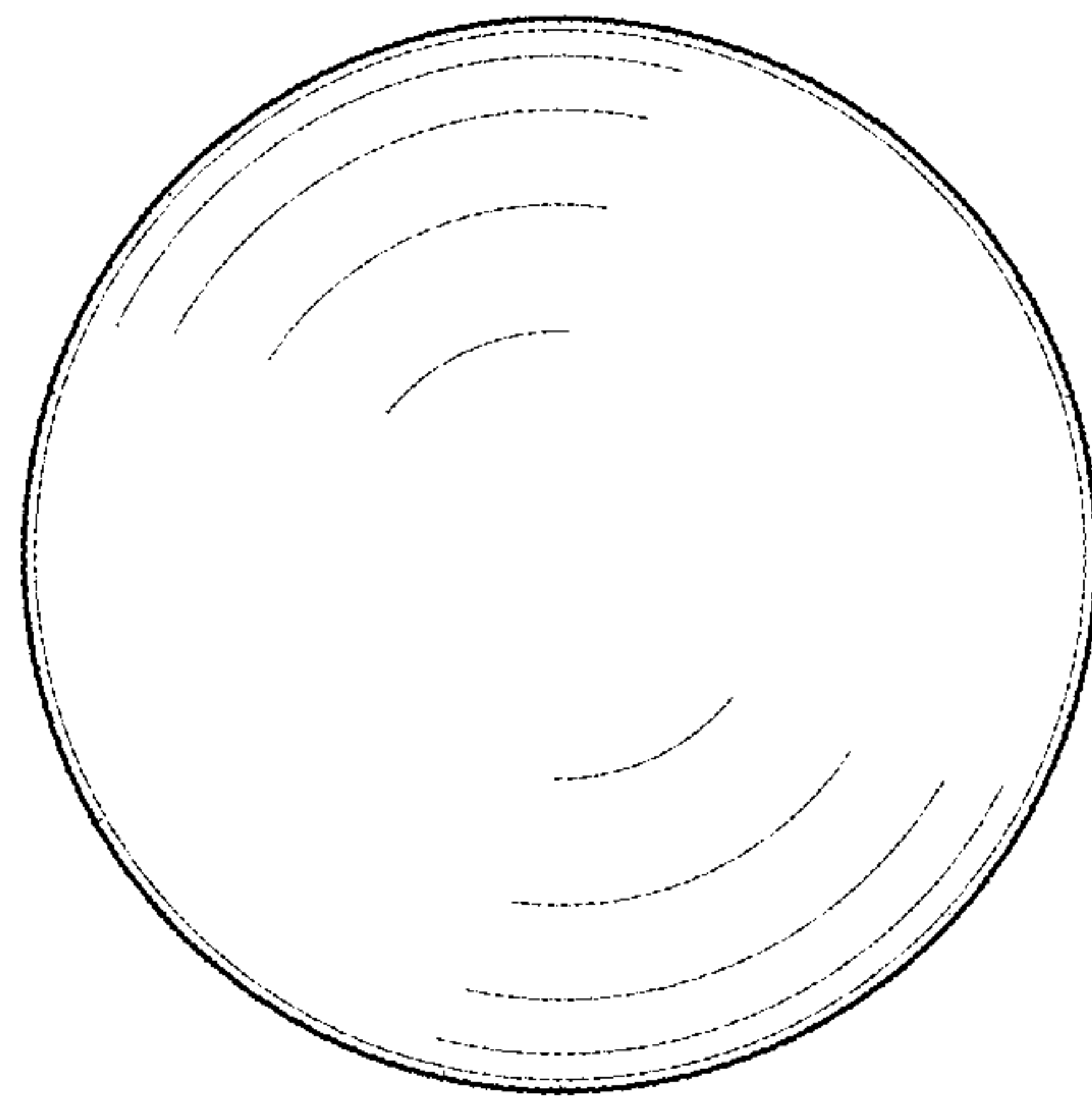

F I G. 6

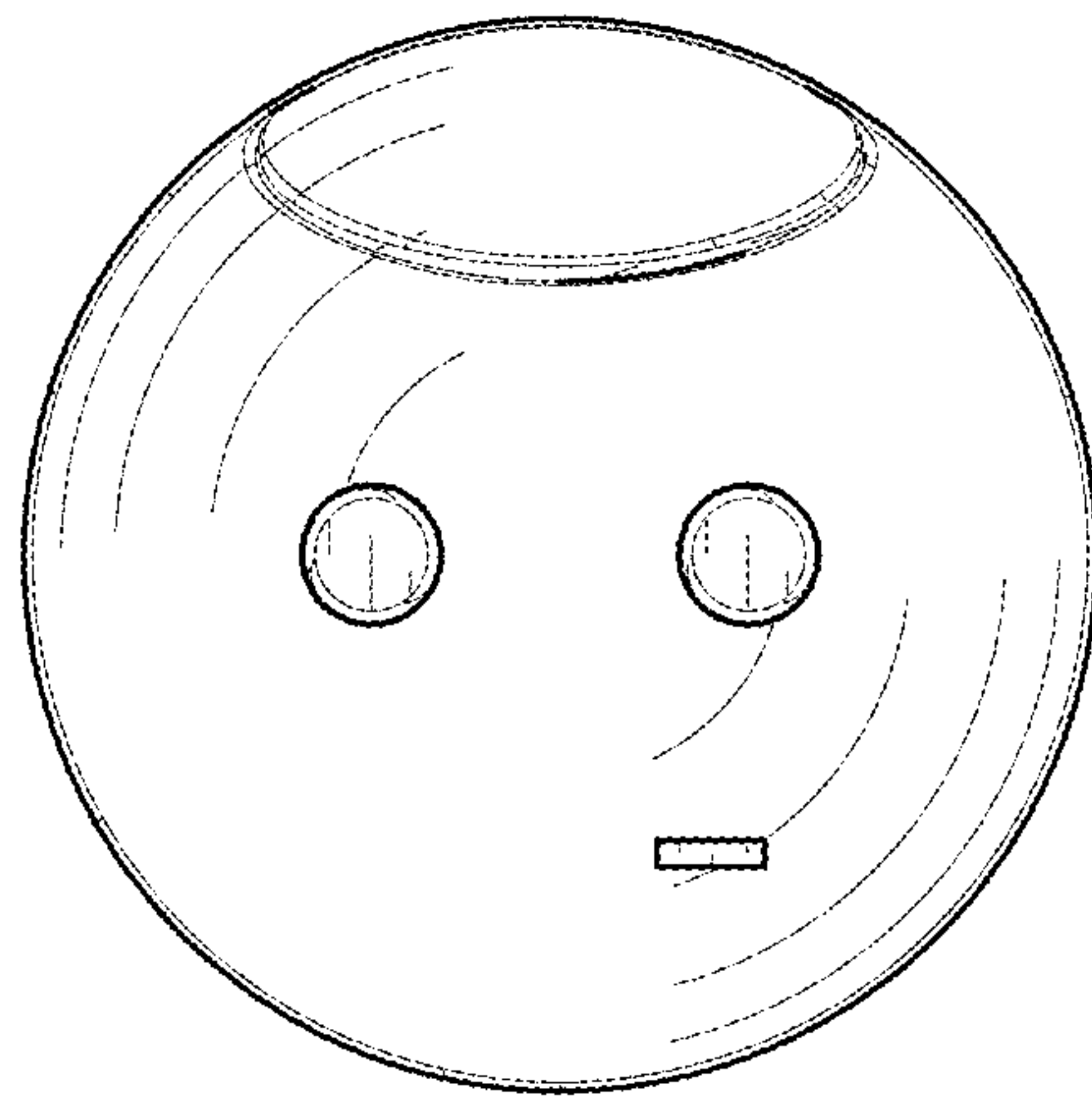

FIG. 7