



US00D975836S

(12) **United States Design Patent**
Sandberg

(10) **Patent No.:** **US D975,836 S**
(45) **Date of Patent:** **** Jan. 17, 2023**

(54) **BREAST PUMP**

- (71) Applicant: **KONINKLIJKE PHILIPS N.V.**,
Eindhoven (NL)
- (72) Inventor: **Emma Stina Katarina Sandberg**,
Amsterdam (NL)
- (73) Assignee: **KONINKLIJKE PHILIPS N.V.**,
Eindhoven (NL)
- (**) Term: **15 Years**
- (21) Appl. No.: **29/735,472**
- (22) Filed: **May 21, 2020**

(30) **Foreign Application Priority Data**

Nov. 26, 2019 (EM) 007297486

(51) **LOC (14) Cl.** **24-02**

(52) **U.S. Cl.**
USPC **D24/109**

(58) **Field of Classification Search**
 USPC D24/107-111, 121, 127, 129, 167, 185,
 D24/193-199, 200, 215, 107-110;
 D3/201, 203.1, 203.2, 273; D10/50, 78,
 D10/81, 104.1; D14/159, 216, 218, 358,
 D14/408; D13/168
 CPC A61M 1/06; A61M 1/062; A61M 1/064;
 A61M 1/067; A61M 1/068; A61M 1/066;
 A61J 13/00; A61F 5/4407
 See application file for complete search history.

(56) **References Cited**

U.S. PATENT DOCUMENTS

- D365,102 S * 12/1995 Gioscia A61M 1/066
D14/218
 - D366,432 S * 1/1996 Wisley A61M 1/06
D10/78
 - D374,631 S * 10/1996 Whittaker A61M 1/06
D10/78
 - D403,972 S * 1/1999 Gaskell D10/50
- (Continued)

FOREIGN PATENT DOCUMENTS

- CN 304106214 * 4/2017
 - CN 304387895 * 12/2017
- (Continued)

OTHER PUBLICATIONS

[Philips Avent Single Electric Breast Pump, SCF391/71], Amazon.com, Date First Available: Dec. 1, 2020 [online], Customer Review Oldest Date: Mar. 10, 2021 [online], site visited: [Apr. 16, 2021], URL: <https://www.amazon.ca/dp/B08LXTBG9Q/>. (Year: 2020).*

Primary Examiner — Jonathan J Han
Assistant Examiner — Amanda J Berlinski

(57) **CLAIM**

The ornamental design for a breast pump, as shown and described.

DESCRIPTION

FIG. 1 is a perspective view showing a first embodiment of a breast pump according to my design;
 FIG. 2 is a front elevational view thereof;
 FIG. 3 is a rear elevational view thereof;
 FIG. 4 is a right side elevational view thereof;
 FIG. 5 is a left side elevational view thereof;
 FIG. 6 is a top plan view thereof;
 FIG. 7 is a bottom plan view thereof;
 FIG. 8 is a perspective view showing a second embodiment of a breast pump according to my design;
 FIG. 9 is a front elevational view thereof;
 FIG. 10 is a rear elevational view thereof;
 FIG. 11 is a right side elevational view thereof;
 FIG. 12 is a left side elevational view thereof;
 FIG. 13 is a top plan view thereof; and,
 FIG. 14 is a bottom plan view thereof.

1 Claim, 10 Drawing Sheets

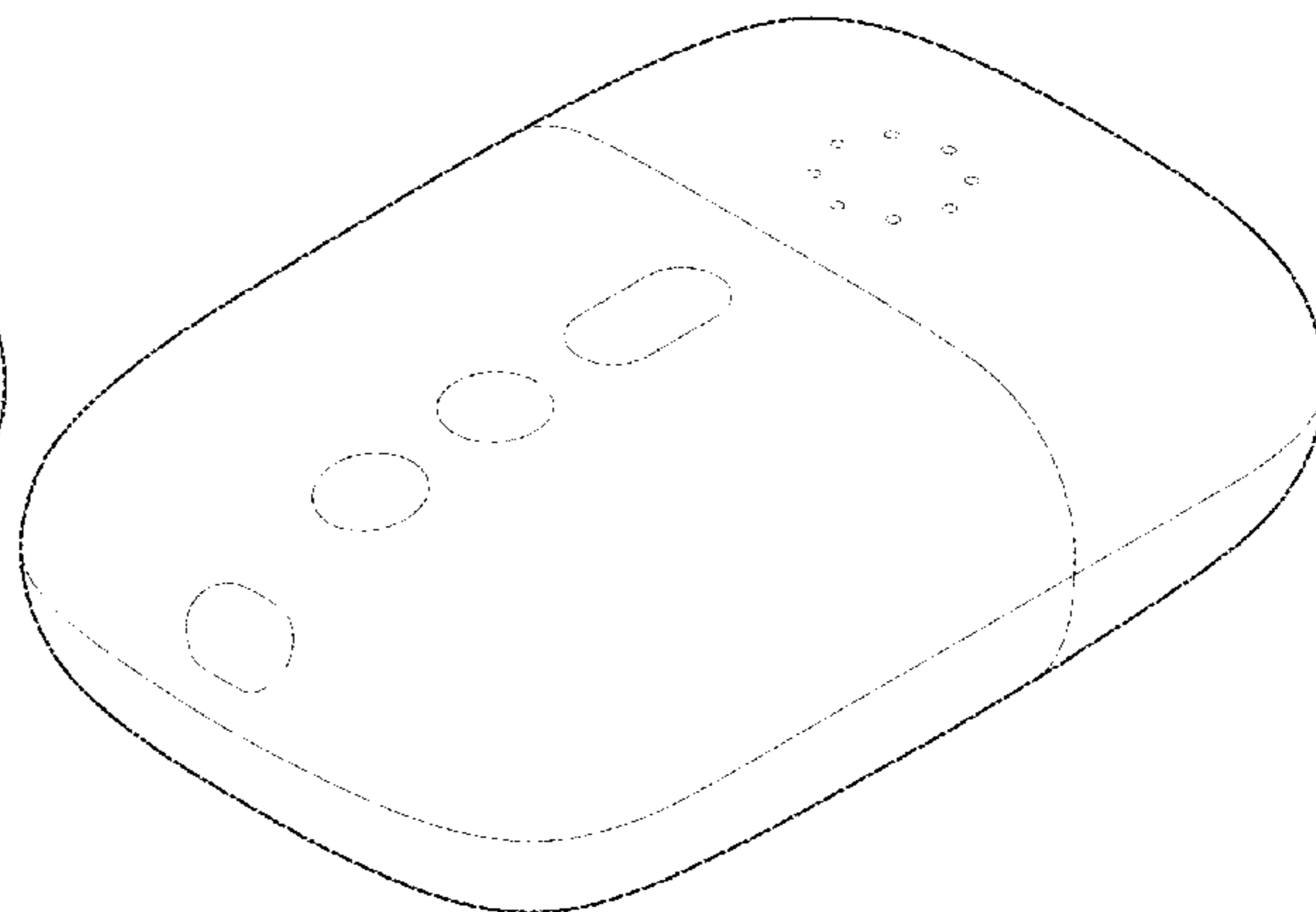
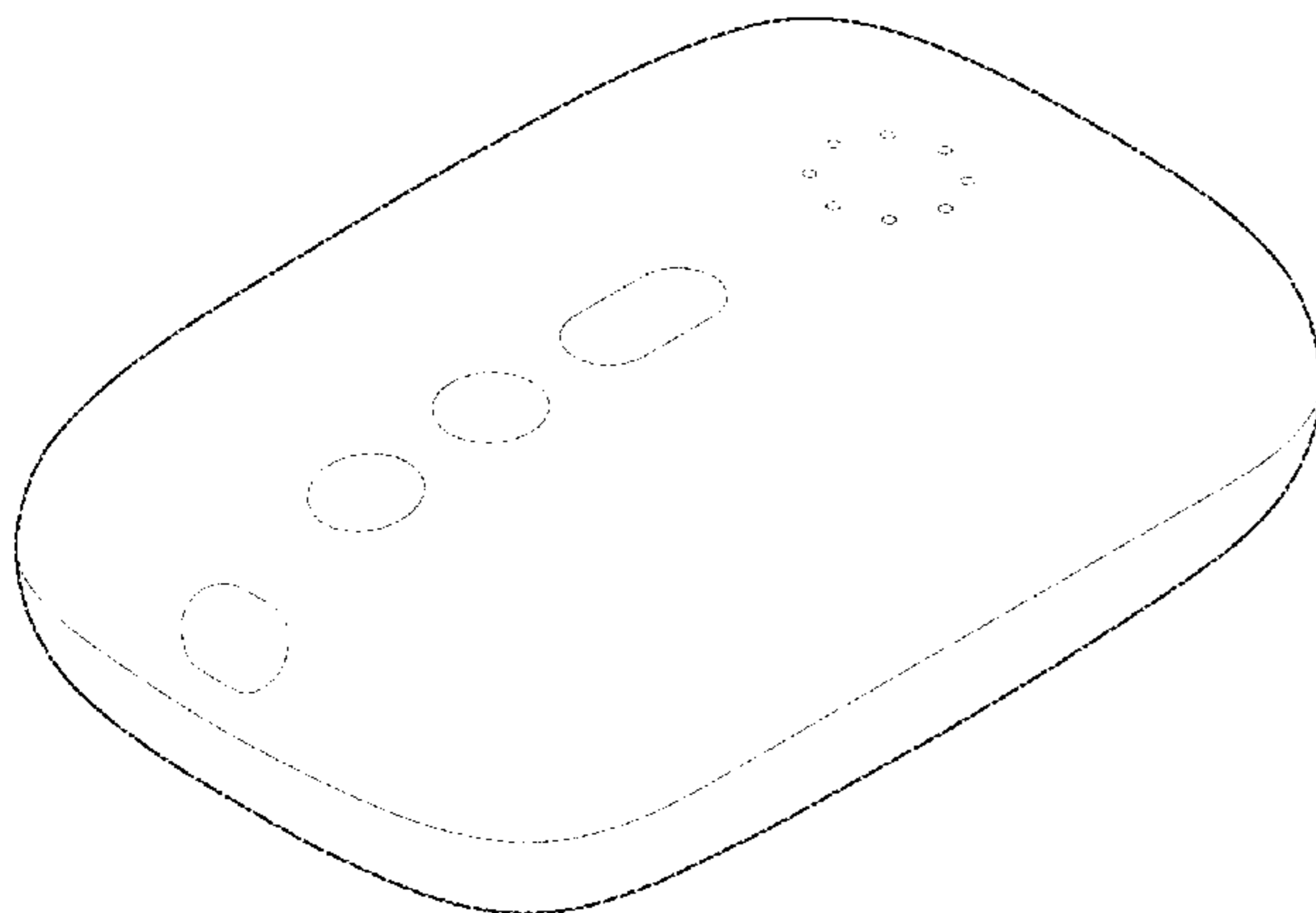

(56)

References Cited

U.S. PATENT DOCUMENTS

D466,215 S * 11/2002 Lindseth D24/167
 D545,225 S * 6/2007 Azuma D10/70
 D576,268 S * 9/2008 Solberg D24/109
 D611,433 S * 3/2010 Tang D13/168
 D624,917 S * 10/2010 Andre D14/408
 D634,115 S * 3/2011 Long, Jr. D3/201
 D675,336 S * 1/2013 Laverack D24/223
 D695,885 S * 12/2013 Thomas D24/109
 D700,084 S * 2/2014 Hsu D10/70
 D715,667 S * 10/2014 Shigeno D10/70
 D722,697 S * 2/2015 Moon D24/169
 D733,288 S * 6/2015 Althorpe D24/110
 D736,111 S * 8/2015 Klein D24/169
 D740,782 S * 10/2015 Thomas D14/159
 D741,297 S * 10/2015 Xi D14/216
 D767,145 S * 9/2016 Liu D24/169
 D770,625 S * 11/2016 Aytekin D24/167
 D782,342 S * 3/2017 Dwivedula D10/53
 D783,170 S * 4/2017 Carreon D24/167
 D794,807 S * 8/2017 Kranz D24/186
 D809,646 S * 2/2018 Mason D24/109
 D811,373 S * 2/2018 Lee D14/218
 D813,852 S * 3/2018 Ni D14/240
 D814,017 S * 3/2018 Muther D24/109
 D814,463 S * 4/2018 Haigh D24/169
 D816,207 S * 4/2018 Sandberg A61M 1/06
 D820,123 S * 6/2018 Chou D10/70
 D830,535 S * 10/2018 Muther D24/109
 D839,583 S * 2/2019 Cao D3/201
 D846,264 S * 4/2019 Wu D3/201
 D870,777 S * 12/2019 Pukall D24/109
 D873,804 S * 1/2020 Garcia D14/218

D874,301 S * 2/2020 Thoni D10/50
 D878,318 S * 3/2020 Sandberg D14/159
 D878,319 S * 3/2020 Sandberg D14/159
 D878,320 S * 3/2020 Sandberg D14/159
 D881,810 S * 4/2020 Zhang D13/108
 D882,815 S * 4/2020 Dumler D24/215
 D884,521 S * 5/2020 Mou D10/81
 D884,522 S * 5/2020 Mou A61M 1/06
 D893,444 S * 8/2020 Sandberg D14/159
 D897,664 S * 10/2020 Li D3/273
 D900,053 S * 10/2020 Sandberg D14/159
 D902,580 S * 11/2020 Amatoury D3/203.1
 D904,005 S * 12/2020 Jung D3/201
 D912,046 S * 3/2021 Huang D14/300
 D914,227 S * 3/2021 Sedic D24/215
 D926,062 S * 7/2021 Konotopskyi D10/104.1
 D926,187 S * 7/2021 Andre D14/408
 D928,642 S * 8/2021 Wang D10/78
 D929,564 S * 8/2021 Lee D24/109
 D934,563 S * 11/2021 Xiang D3/294
 D935,641 S * 11/2021 Zhou D24/231
 D937,109 S * 11/2021 Wang D10/78
 D944,524 S * 3/2022 Laffon de Mazieres D3/294
 D945,995 S * 3/2022 Reichert D14/356
 2015/0265753 A1 * 9/2015 Prentice A61M 1/06
 604/74
 2021/0093760 A1 * 4/2021 Choi A61M 1/066
 2021/0128805 A1 * 5/2021 Amra A61M 1/06

FOREIGN PATENT DOCUMENTS

CN 305570215 * 1/2020
 CN 305914894 * 7/2020
 CN 306797366 * 8/2021

* cited by examiner

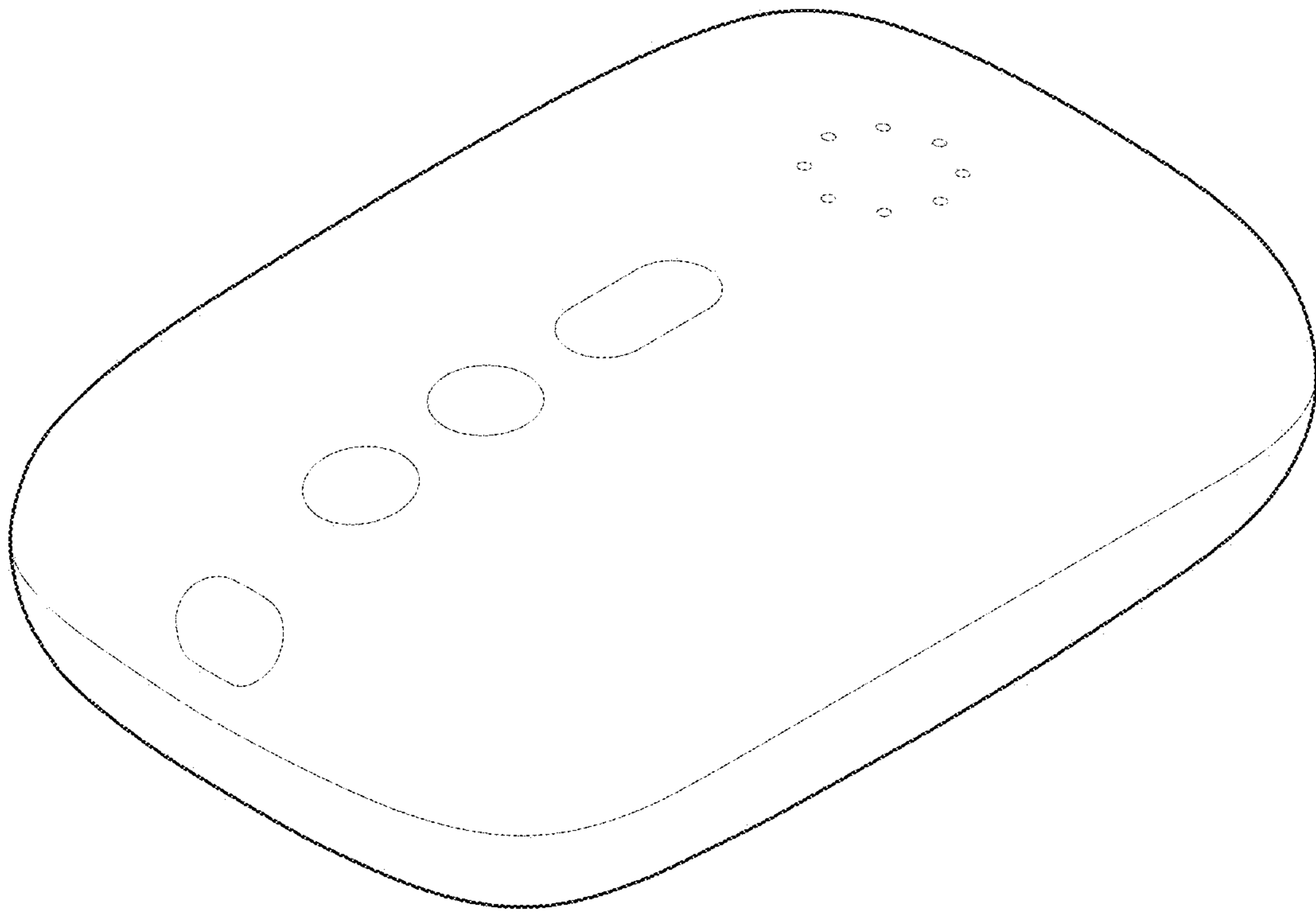

FIG. 1

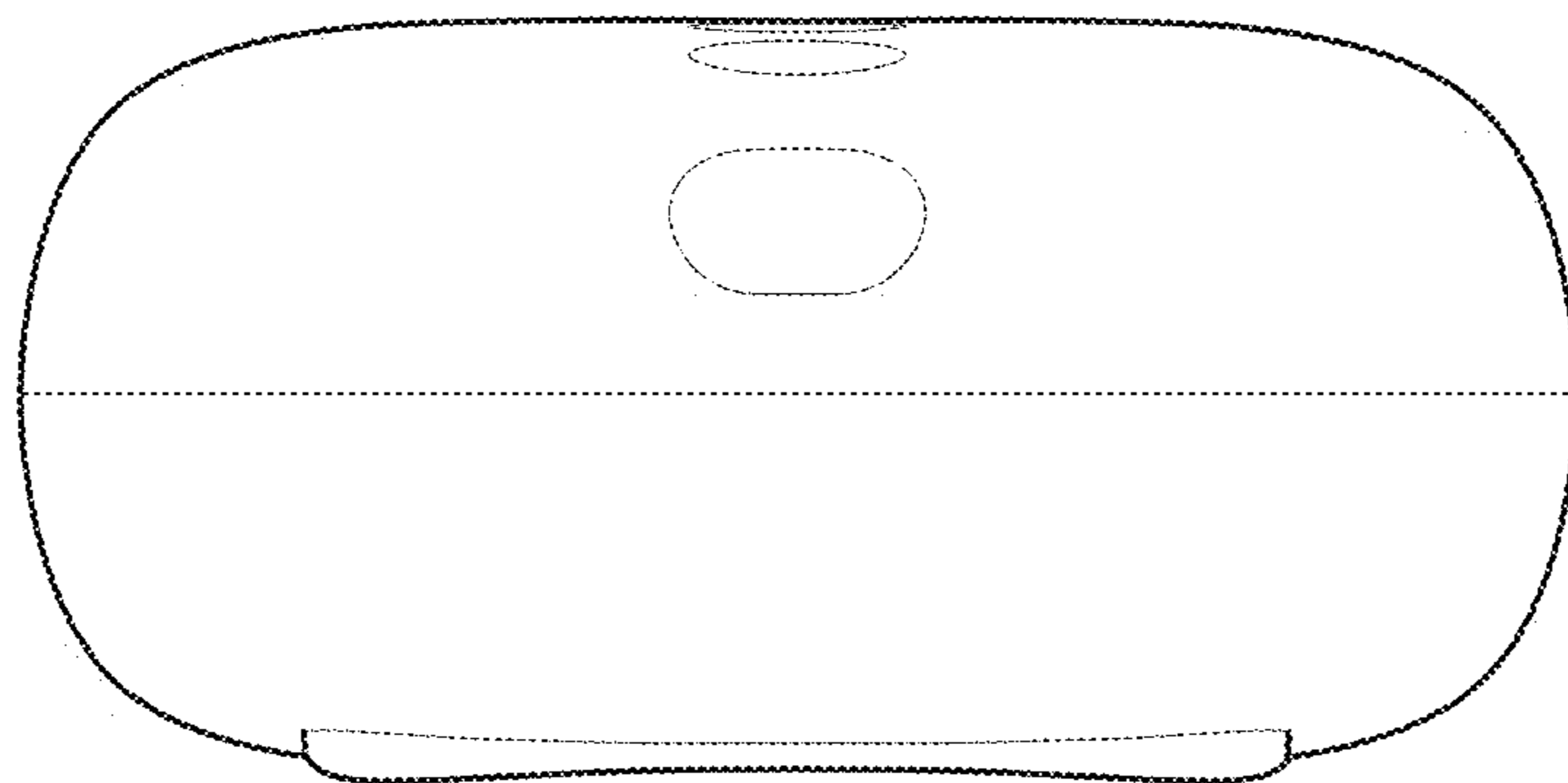

FIG. 2

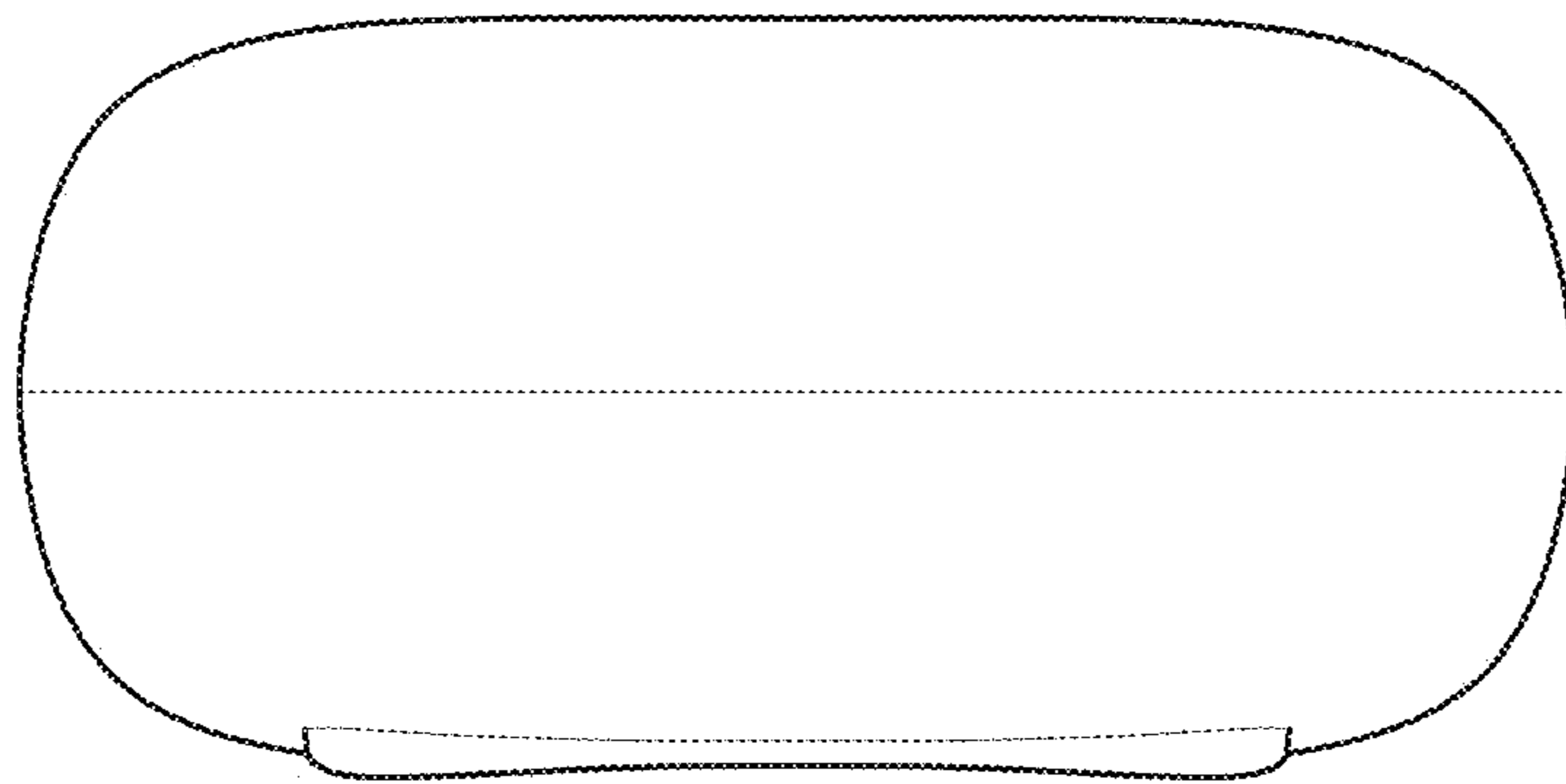

FIG. 3

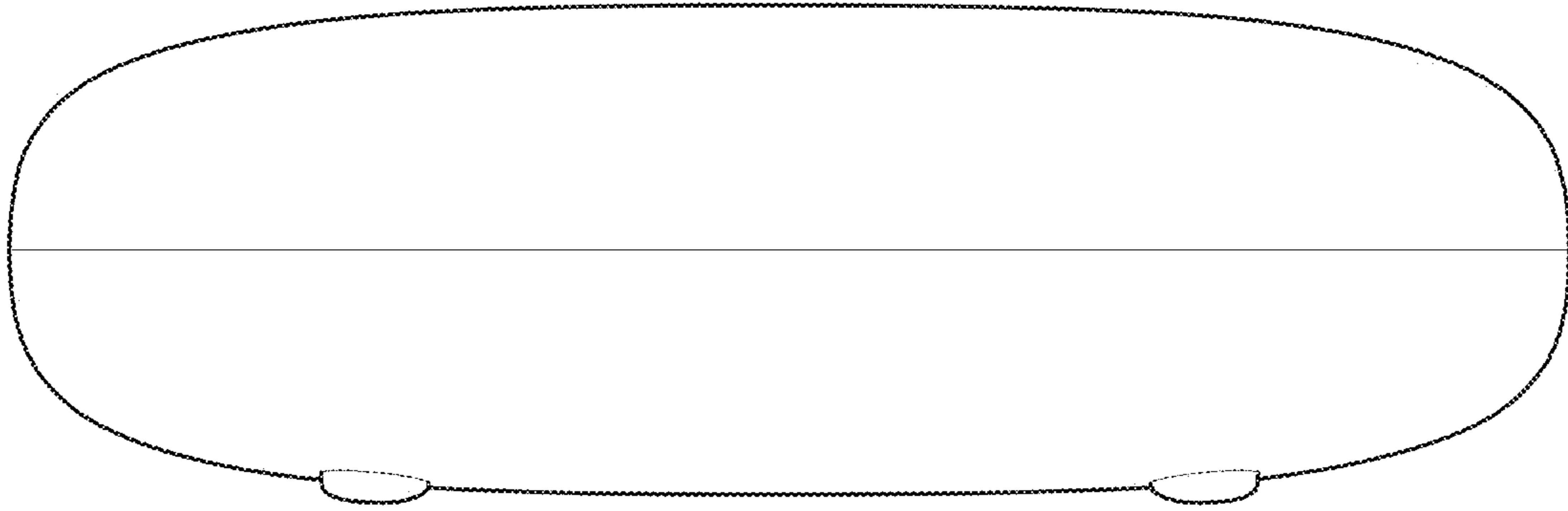

FIG. 4

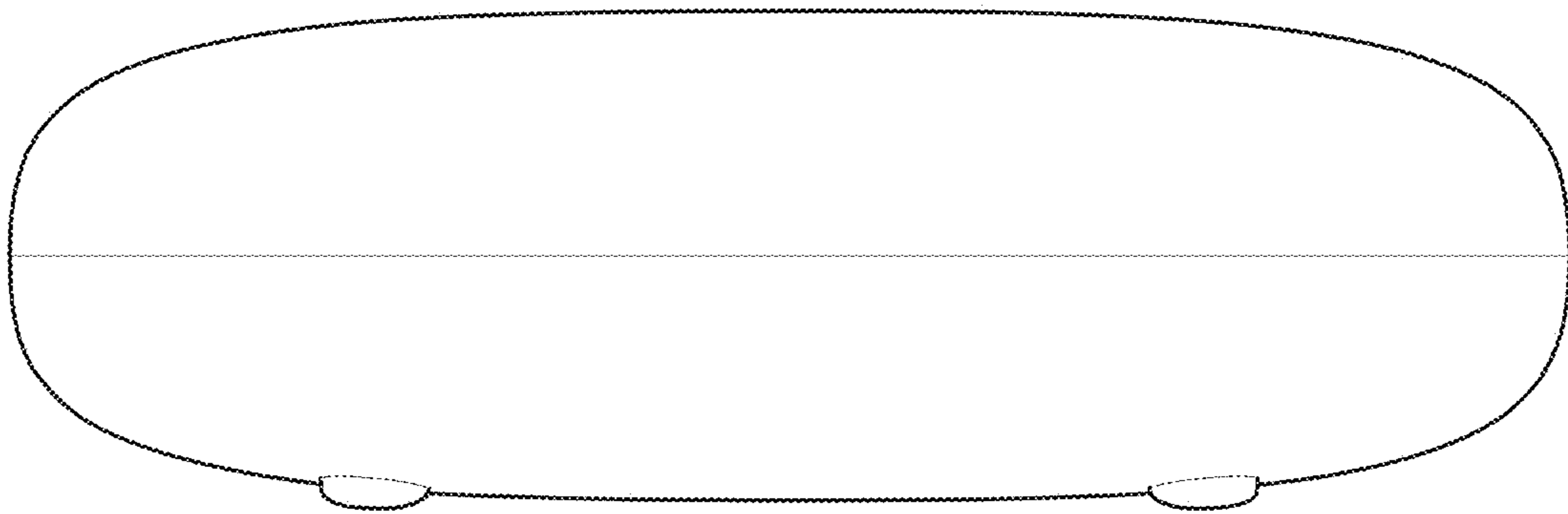

FIG. 5

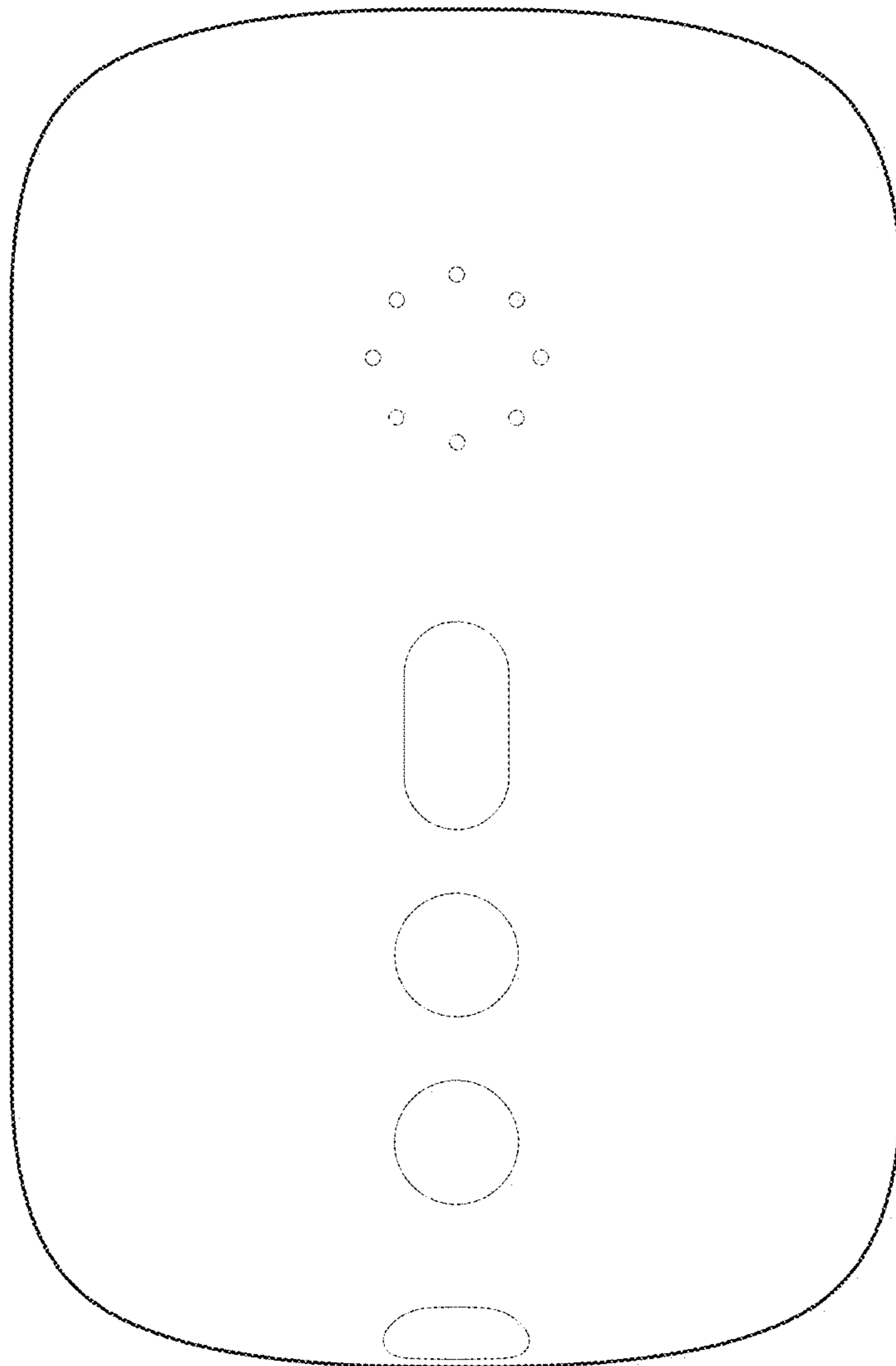

FIG. 6

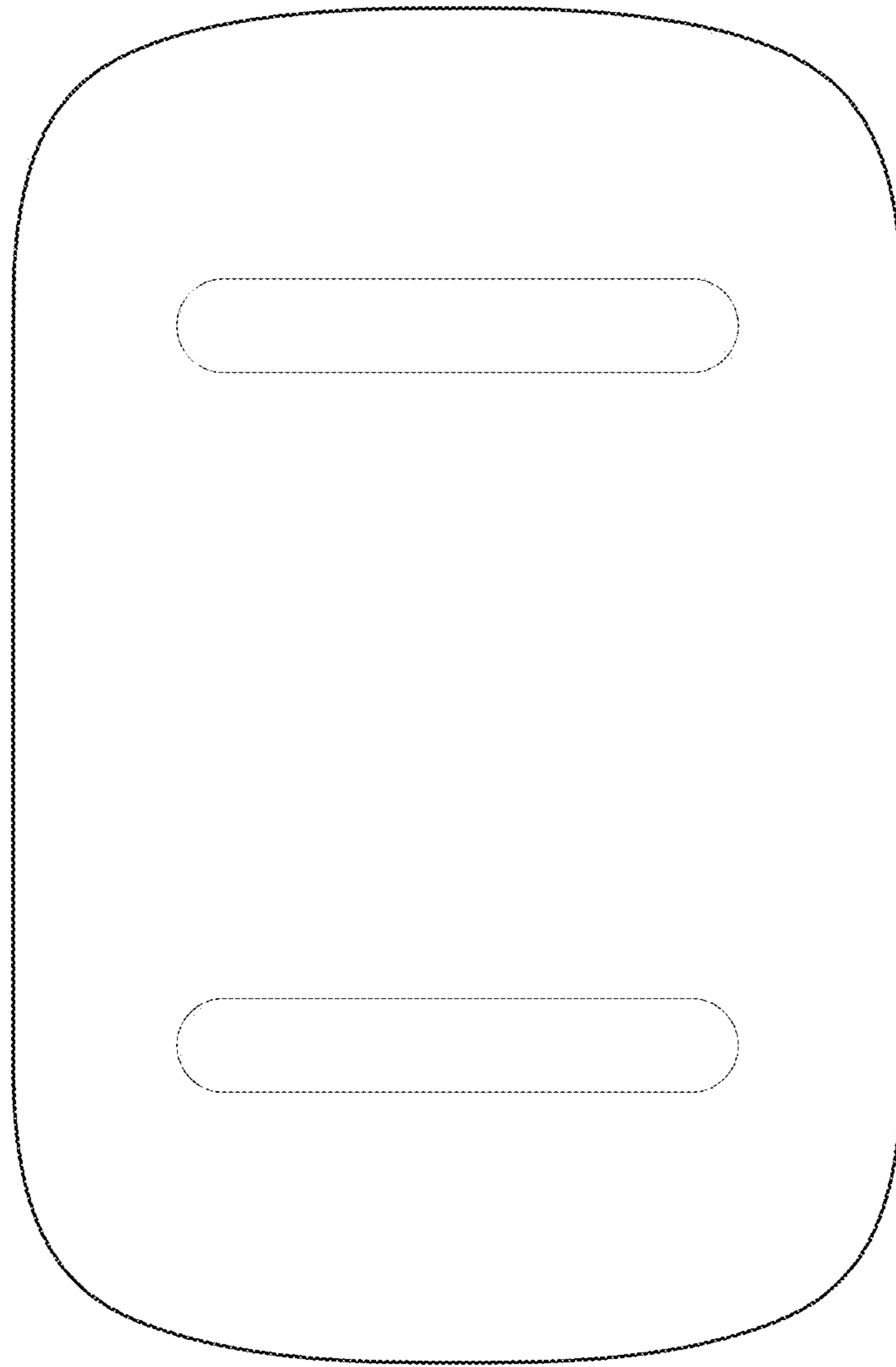

FIG. 7

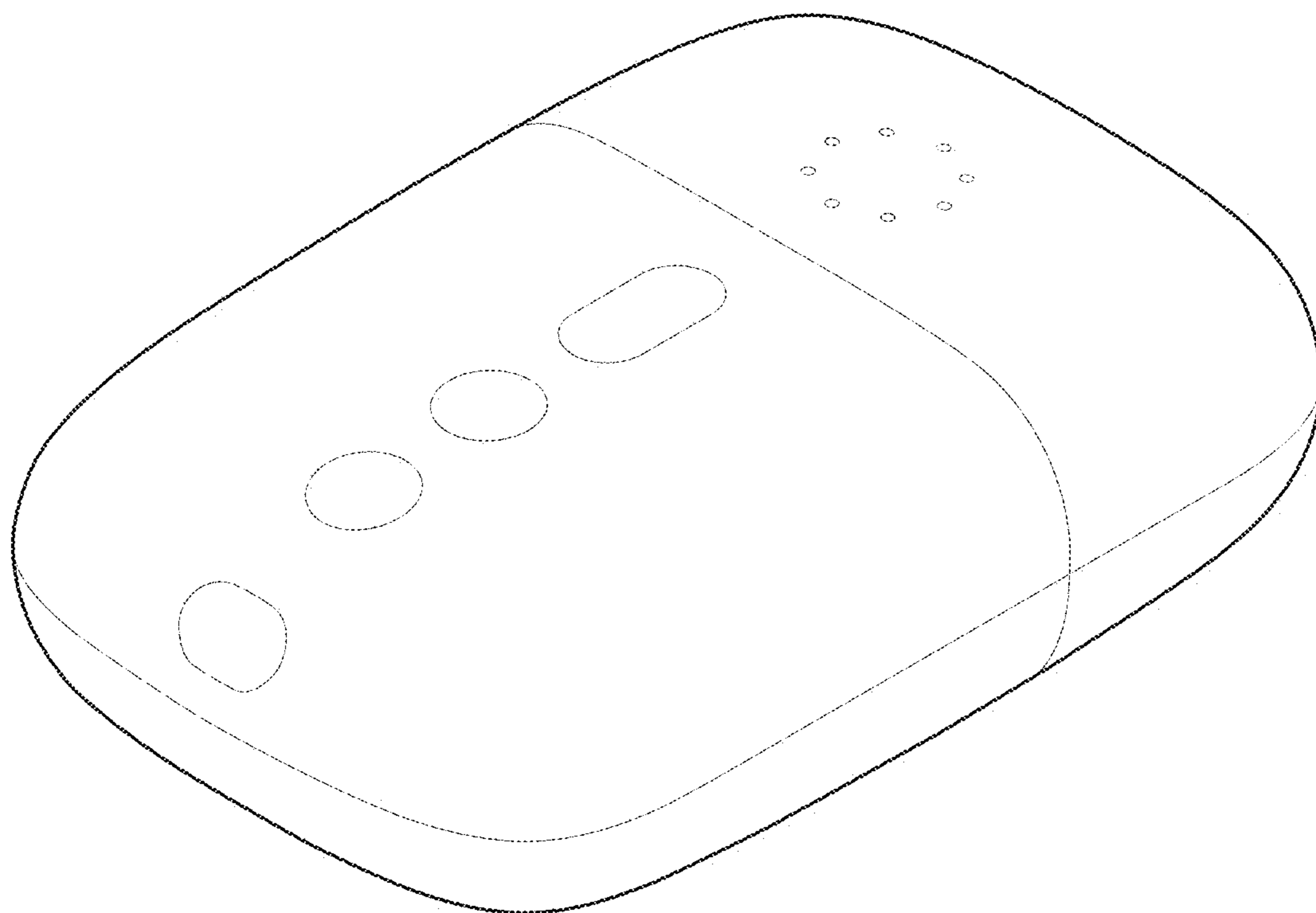

FIG. 8

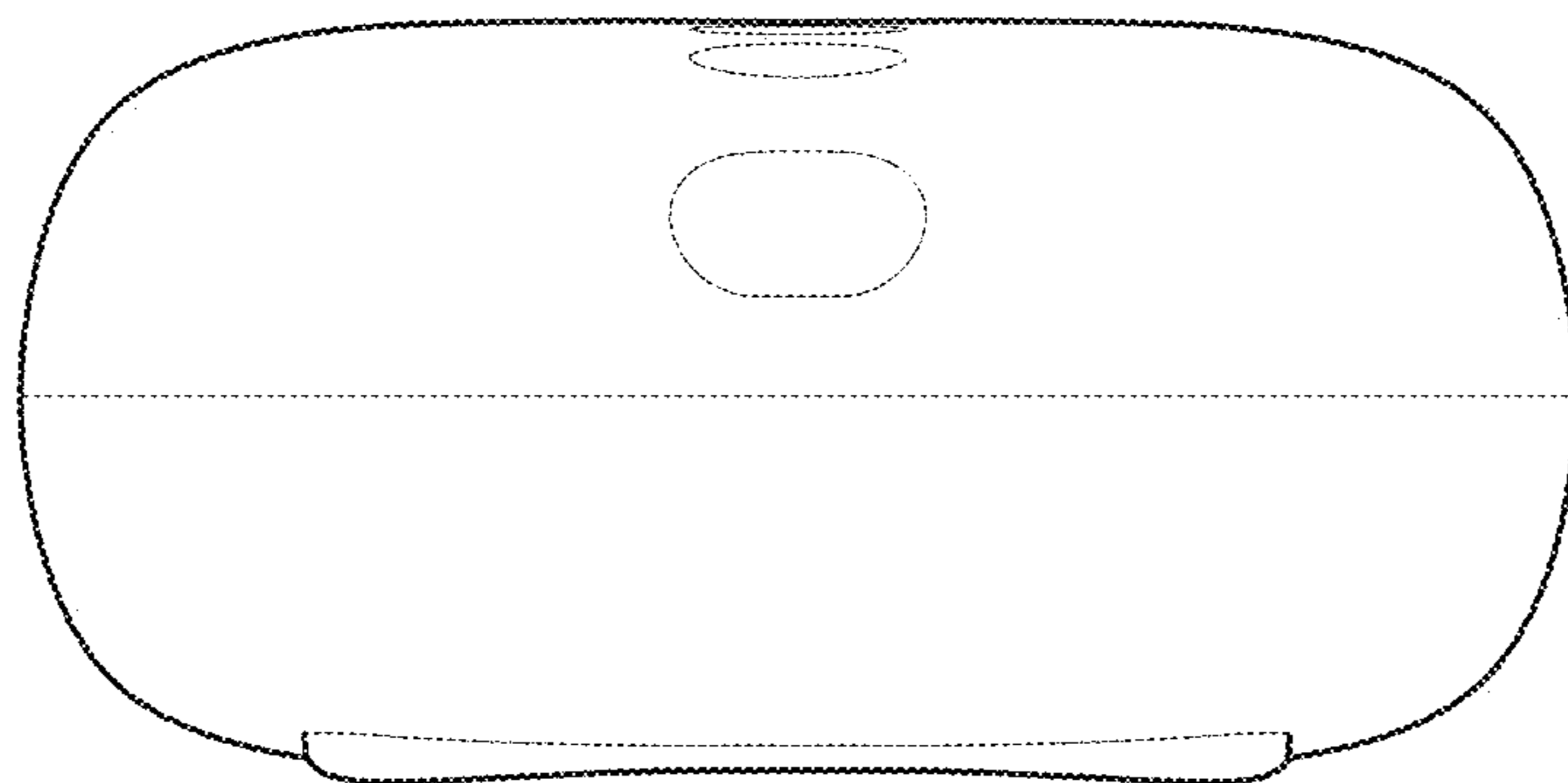

FIG. 9

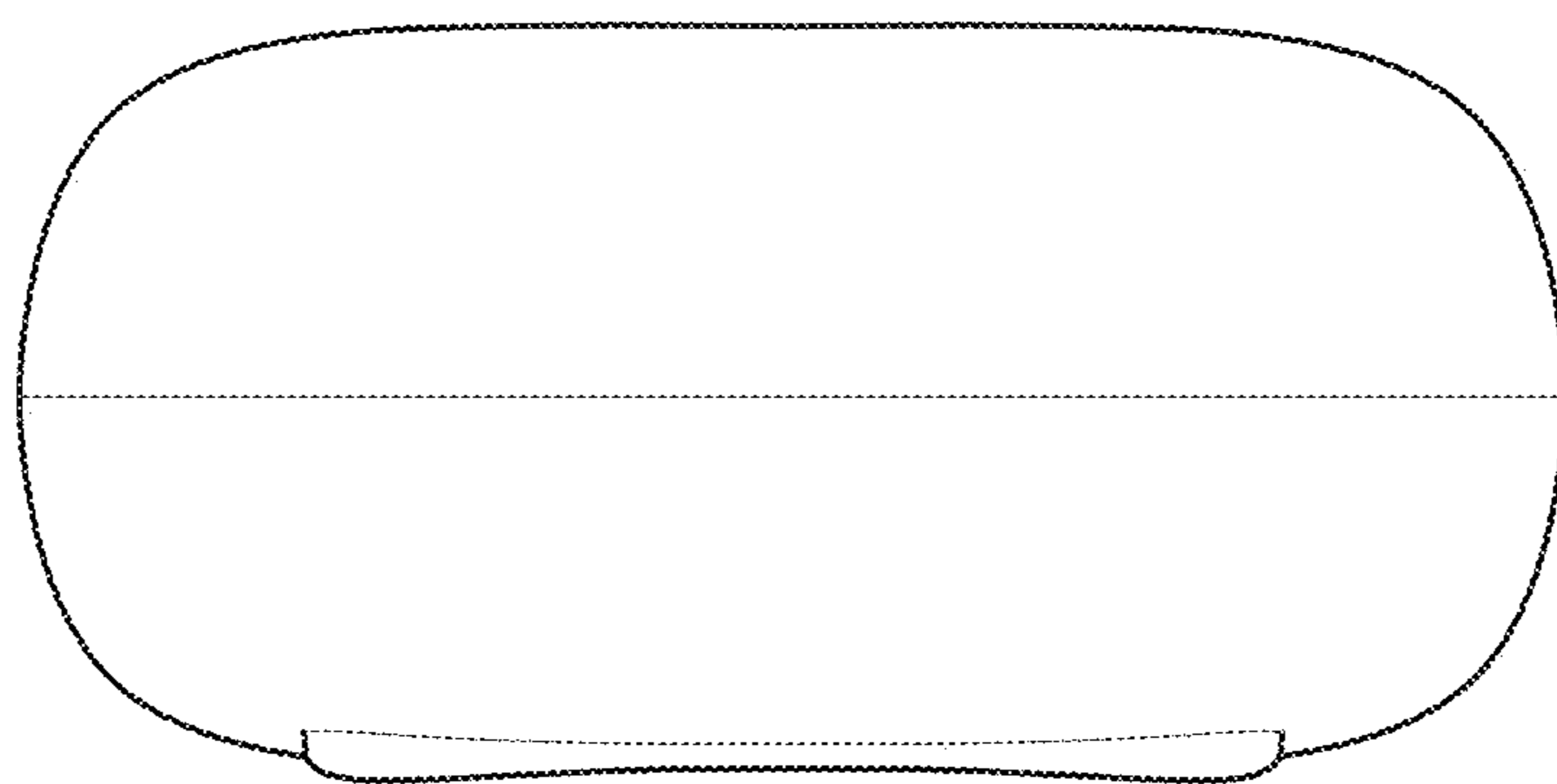

FIG. 10

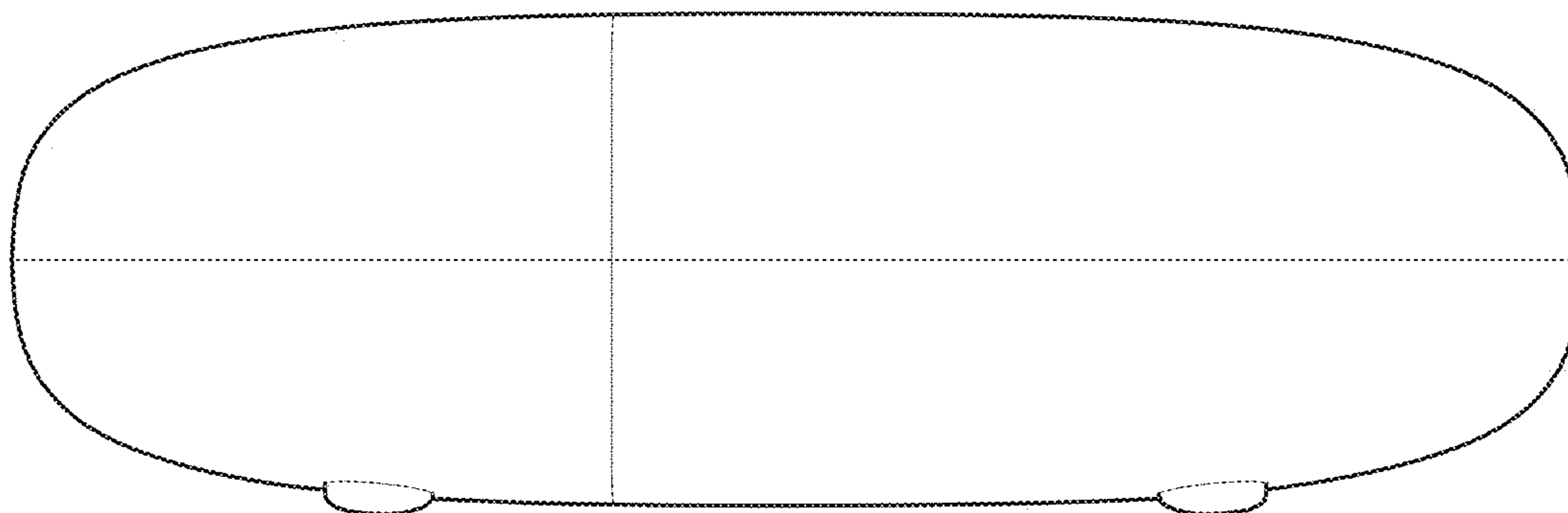

FIG. 11

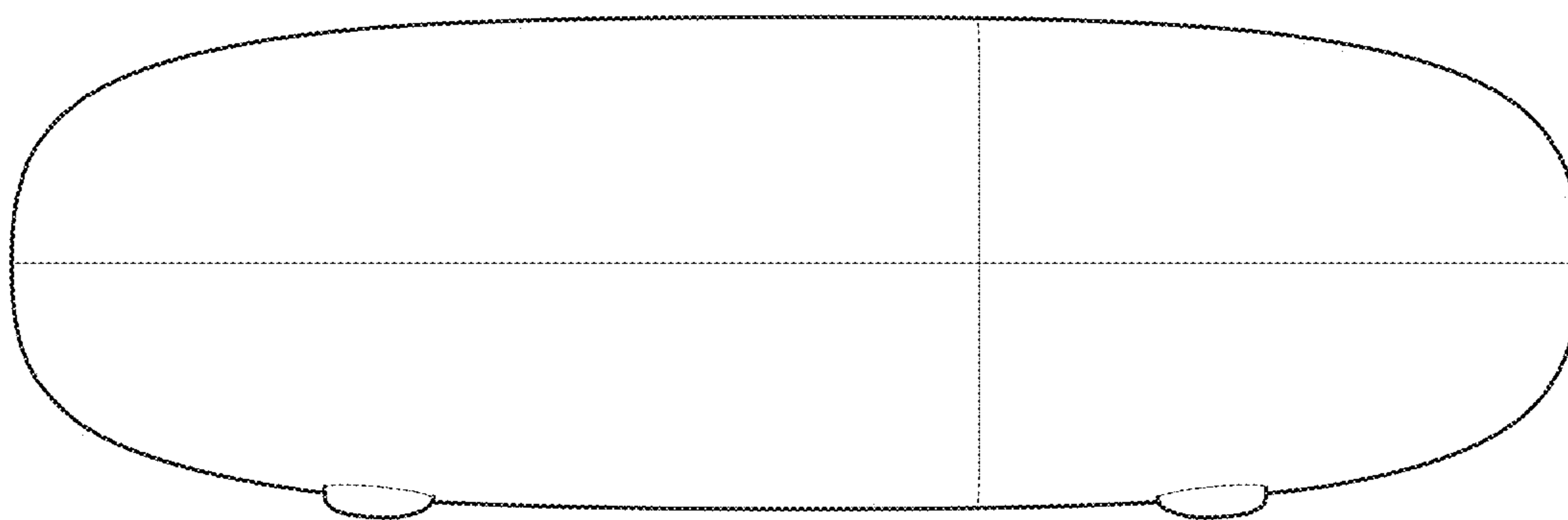

FIG. 12

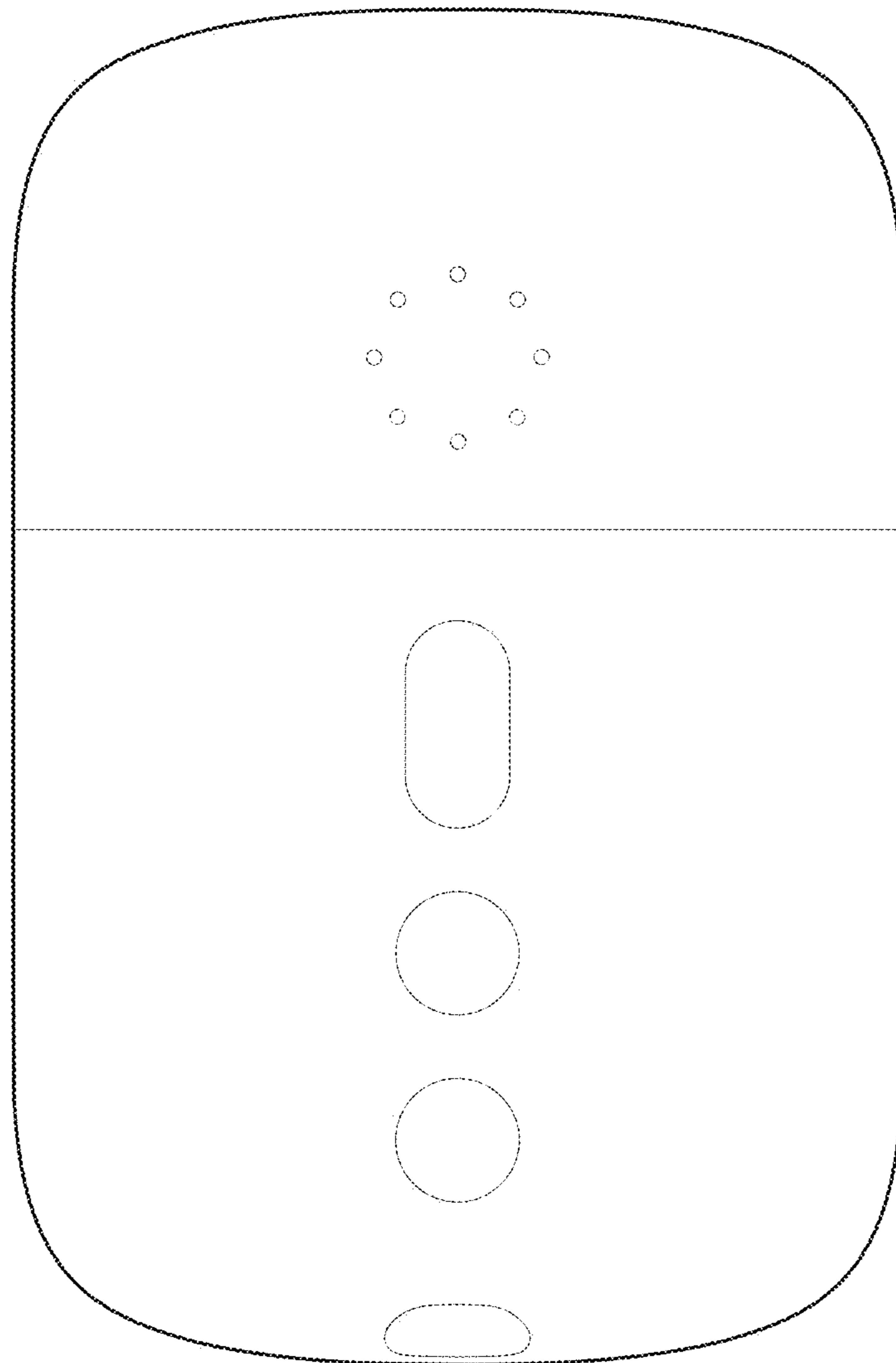

FIG. 13

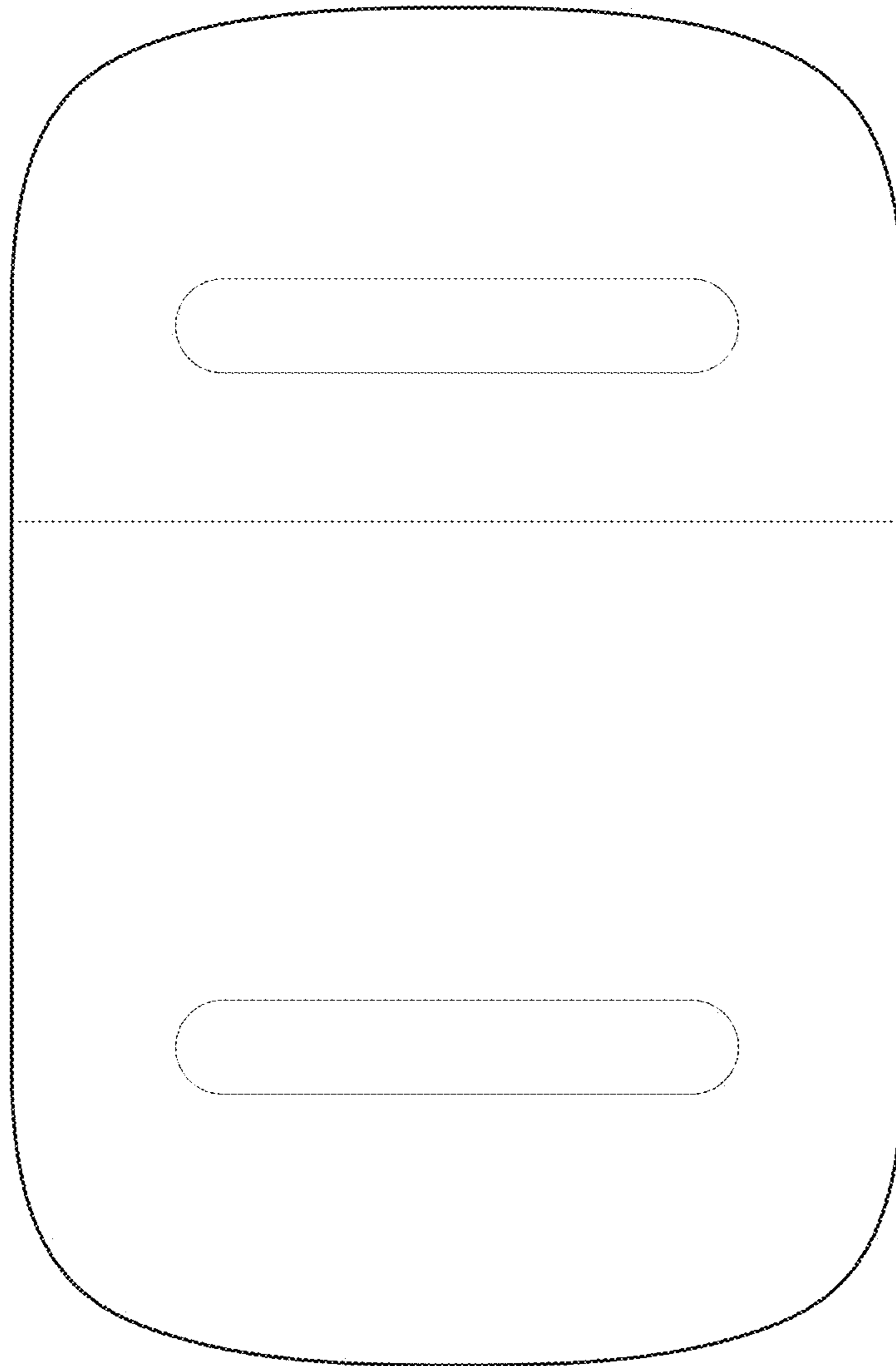

FIG. 14