



US00D975823S

(12) **United States Design Patent**
Chang

(10) **Patent No.:** **US D975,823 S**

(45) **Date of Patent:** **** Jan. 17, 2023**

(54) **FAUCET**

D946,119 S * 3/2022 Levi D23/238
D954,196 S * 6/2022 Downey D23/238
D964,520 S * 9/2022 Kulig D23/238

(71) Applicant: **Juanhong Chang**, Suzhou (CN)

(72) Inventor: **Juanhong Chang**, Suzhou (CN)

(**) Term: **15 Years**

(21) Appl. No.: **29/865,476**

(22) Filed: **Jul. 27, 2022**

(51) **LOC (14) Cl.** **23-01**

(52) **U.S. Cl.**
USPC **D23/238**

(58) **Field of Classification Search**
USPC D23/213, 214, 215, 223, 224, 226, 229,
D23/230, 238
CPC A61H 9/0021; A61H 33/00; B05B 1/00;
B05B 1/14; B05B 1/185; B05B 1/08;
B05B 1/02; B05B 1/26; B05B 12/002;
B05B 1/18; B05B 9/01
See application file for complete search history.

(56) **References Cited**

U.S. PATENT DOCUMENTS

D557,380	S	*	12/2007	Shieh	D23/238
D811,527	S		2/2018	Fritz		
D835,237	S	*	12/2018	Ziemann	D23/238
D835,238	S	*	12/2018	Ziemann	D23/238
D862,652	S	*	10/2019	Zeng	D23/238
D873,961	S		1/2020	Garland		
D917,014	S	*	4/2021	Wang	D23/238
D919,051	S	*	5/2021	Zeng	D23/238
D924,362	S	*	7/2021	Zhu	D23/238
D927,647	S	*	8/2021	Liang	D23/238
D931,416	S	*	9/2021	Chen	D23/238
D935,565	S	*	11/2021	Liu	D23/238

OTHER PUBLICATIONS

OWOFAN Kitchen Faucets Commercial Solid Brass Single Handle Single Lever Pull Down Sprayer, May 23, 2018, amazon.com, Sep. 21, 2022, URL: <https://www.amazon.com/dp/B07D8F5NCW/> (Year: 2018).*

Bathfinesse Kitchen Faucet with Pull Down Sprayer Faucet, Jun. 18, 2021, amazon.com, Sep. 21, 2022, URL: <https://www.amazon.com/dp/B094C3CH71/> (Year: 2021).*

BWE Black Kitchen Faucet with Pull Down Sprayer 3 Function, Mar. 9, 2022, amazon.com, Sep. 21, 2022, URL: <https://www.amazon.com/dp/B09FGG4JZF/> (Year: 2022).*

* cited by examiner

Primary Examiner — Keith J Wilson

(57) **CLAIM**

The ornamental design for a faucet, as shown and described.

DESCRIPTION

FIG. 1 is a perspective view of a faucet showing my new design;

FIG. 2 is another perspective view thereof;

FIG. 3 is a front elevational view thereof;

FIG. 4 is a rear elevational view thereof;

FIG. 5 is a left side elevational view thereof;

FIG. 6 is a right side elevational view thereof;

FIG. 7 is a top plan view thereof; and,

FIG. 8 is a bottom plan view thereof.

The broken lines in the drawings depict portions of the faucet that form no part of the claimed design.

1 Claim, 8 Drawing Sheets

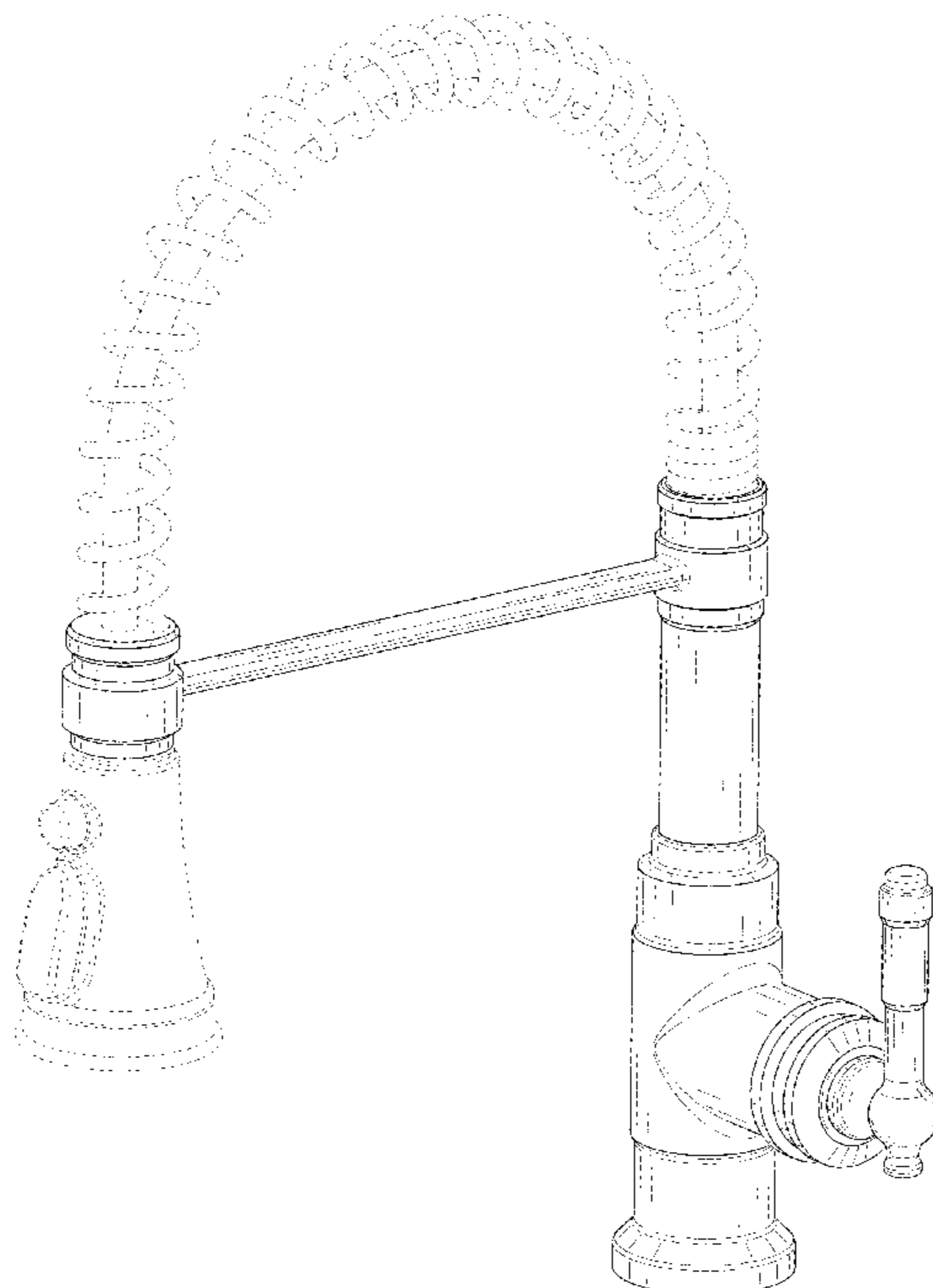

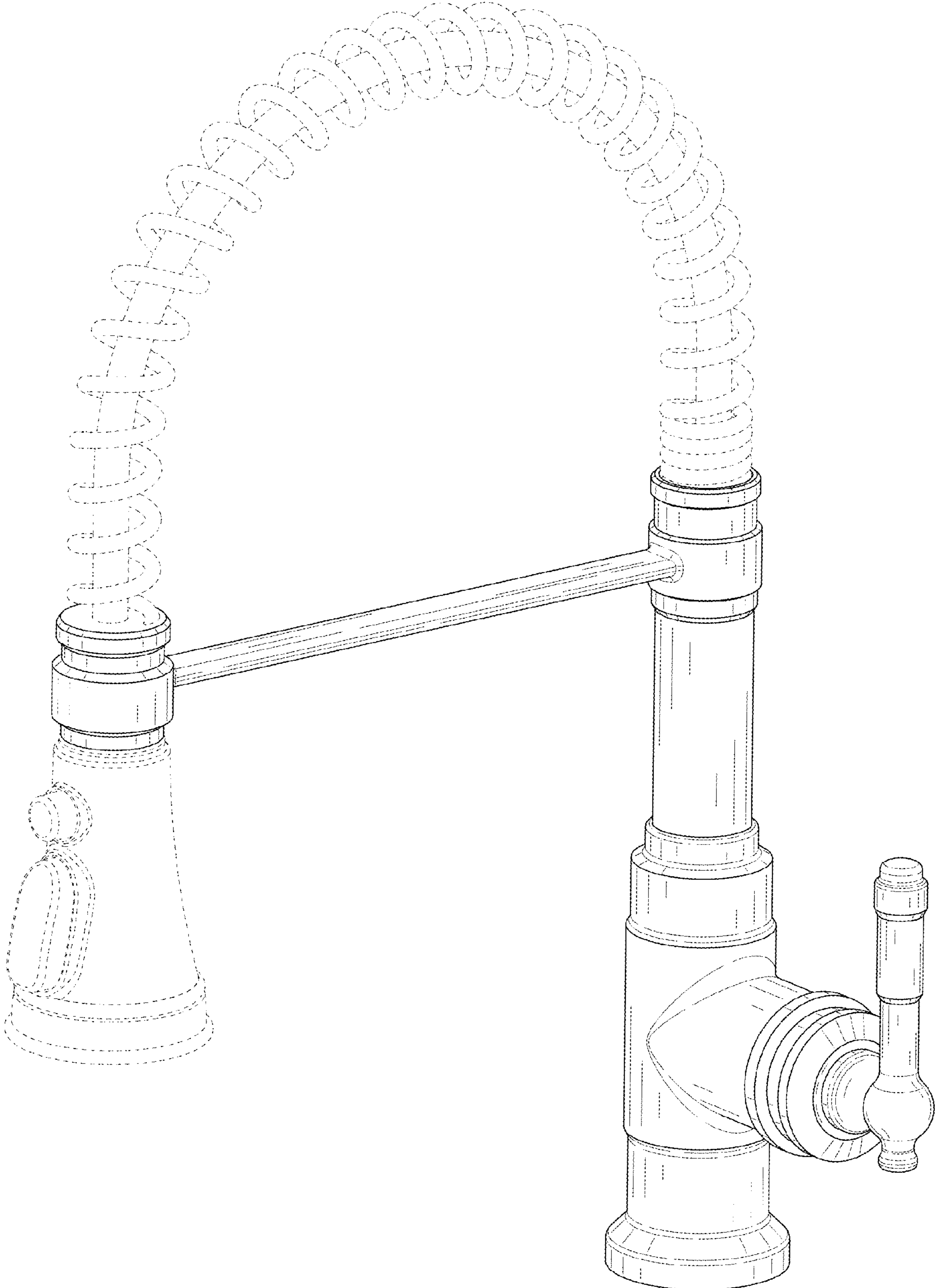

FIG. 1

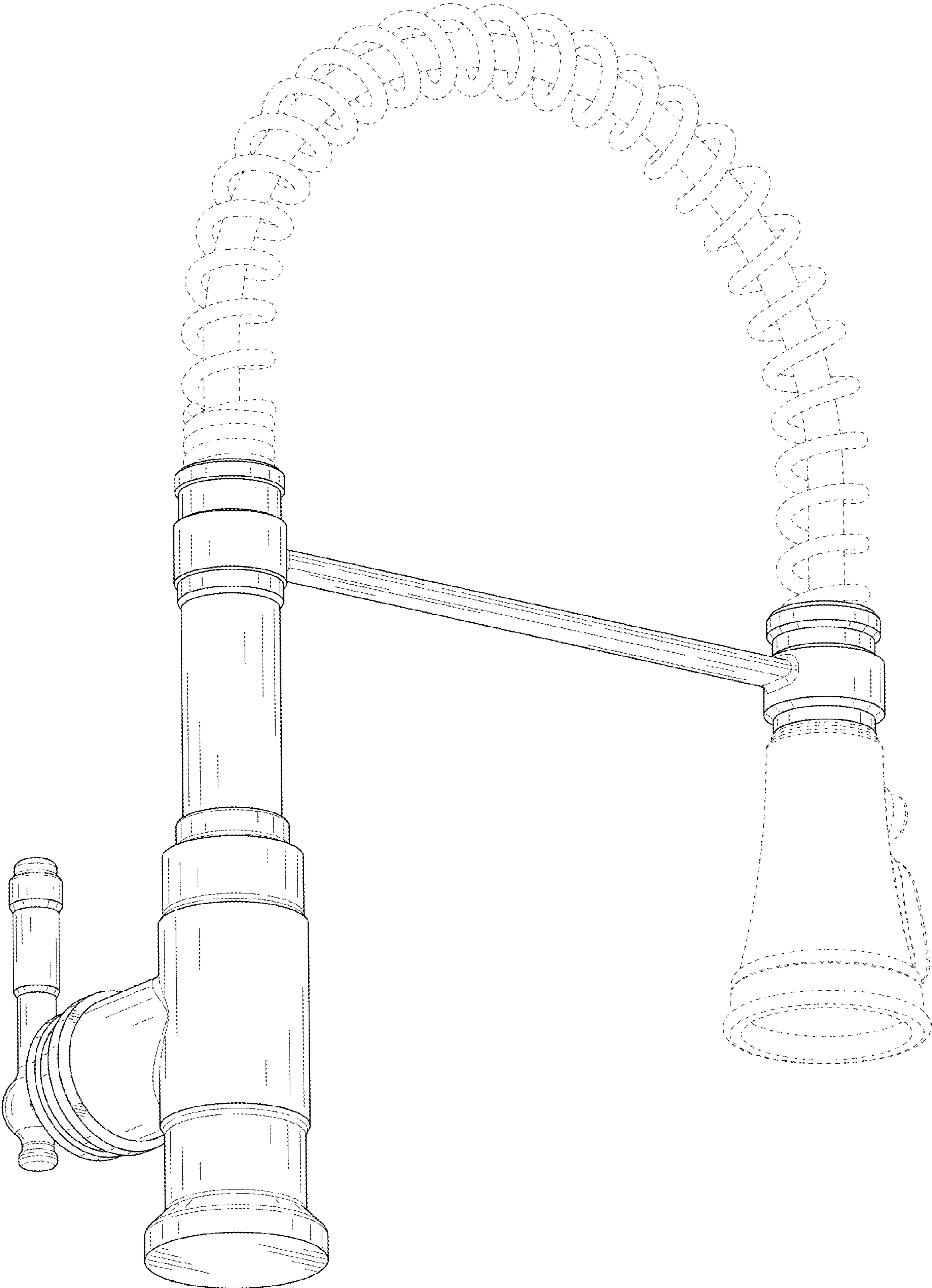

FIG. 2

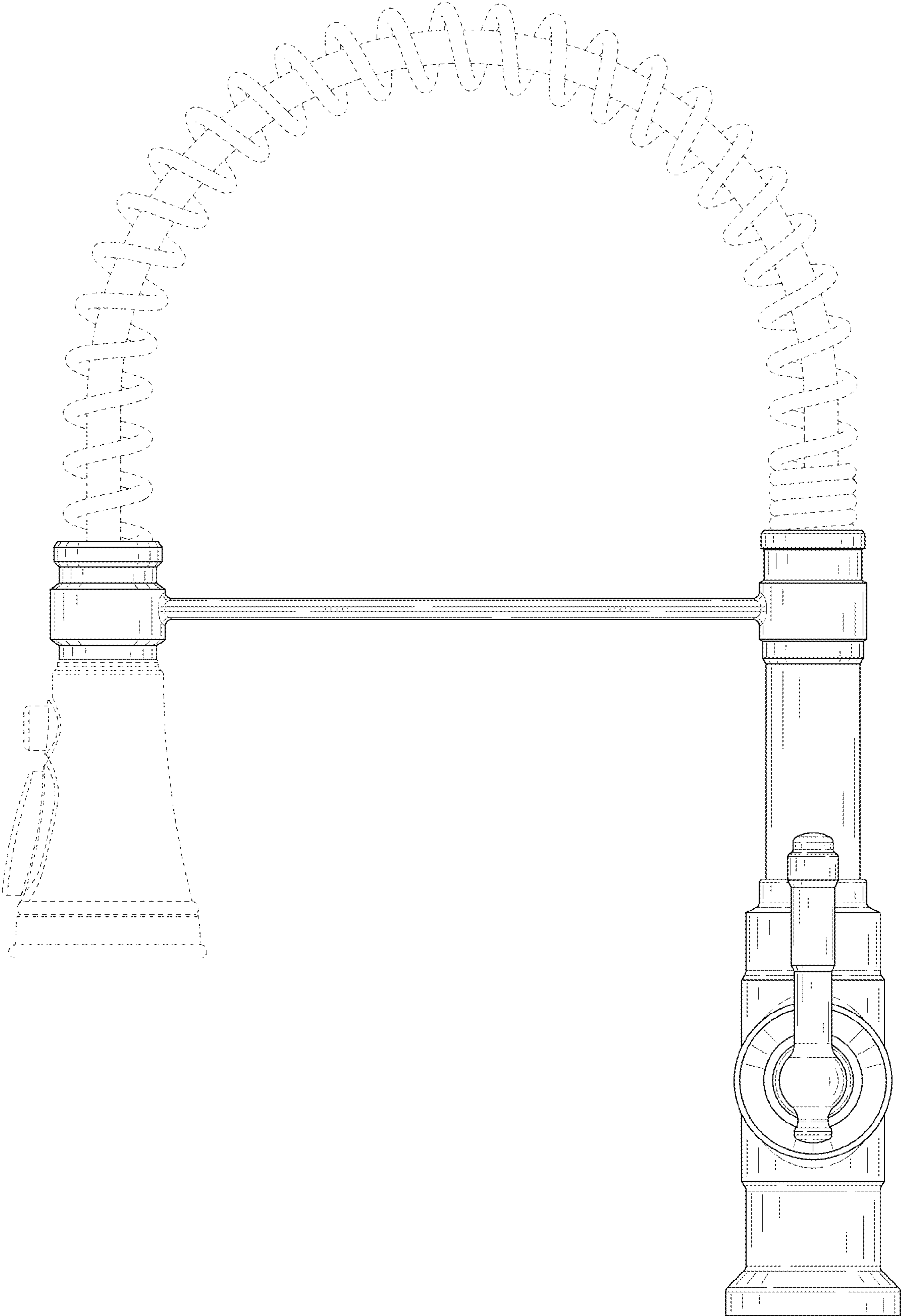

FIG. 3

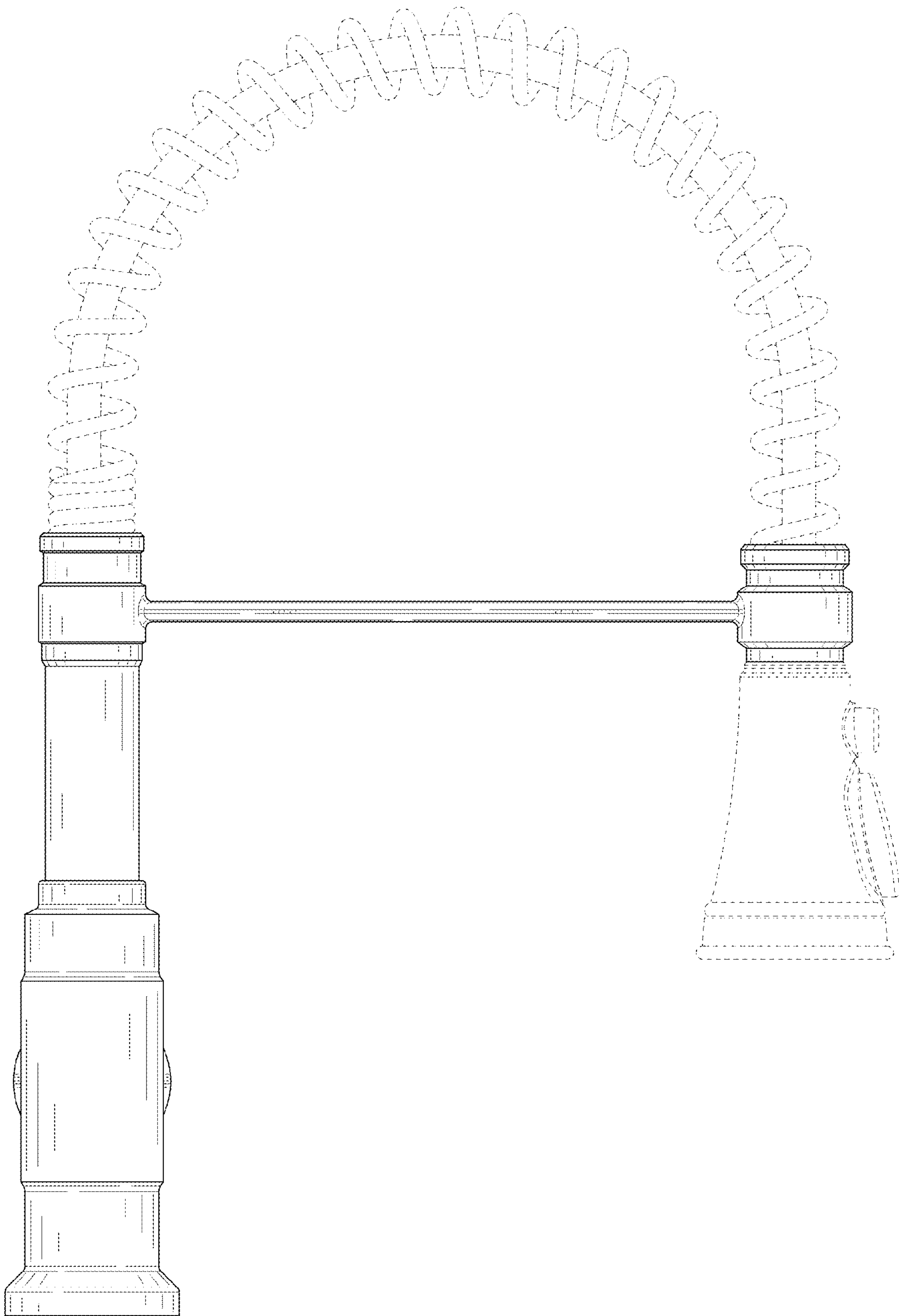

FIG. 4

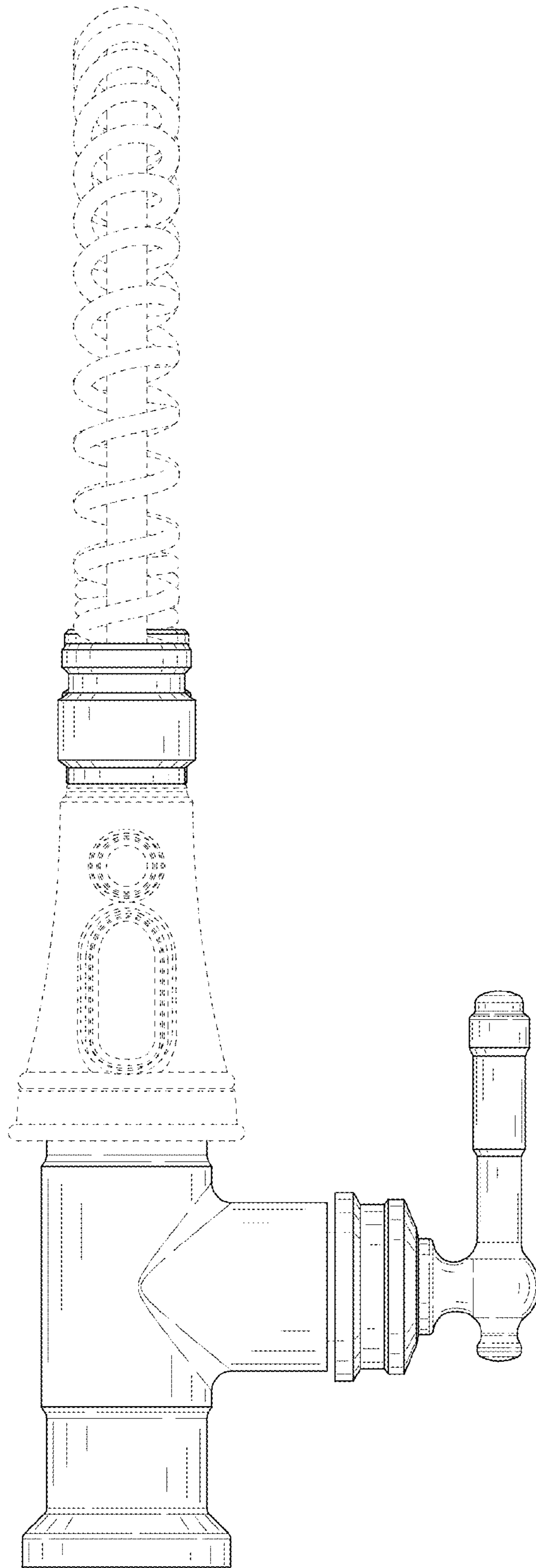

FIG. 5

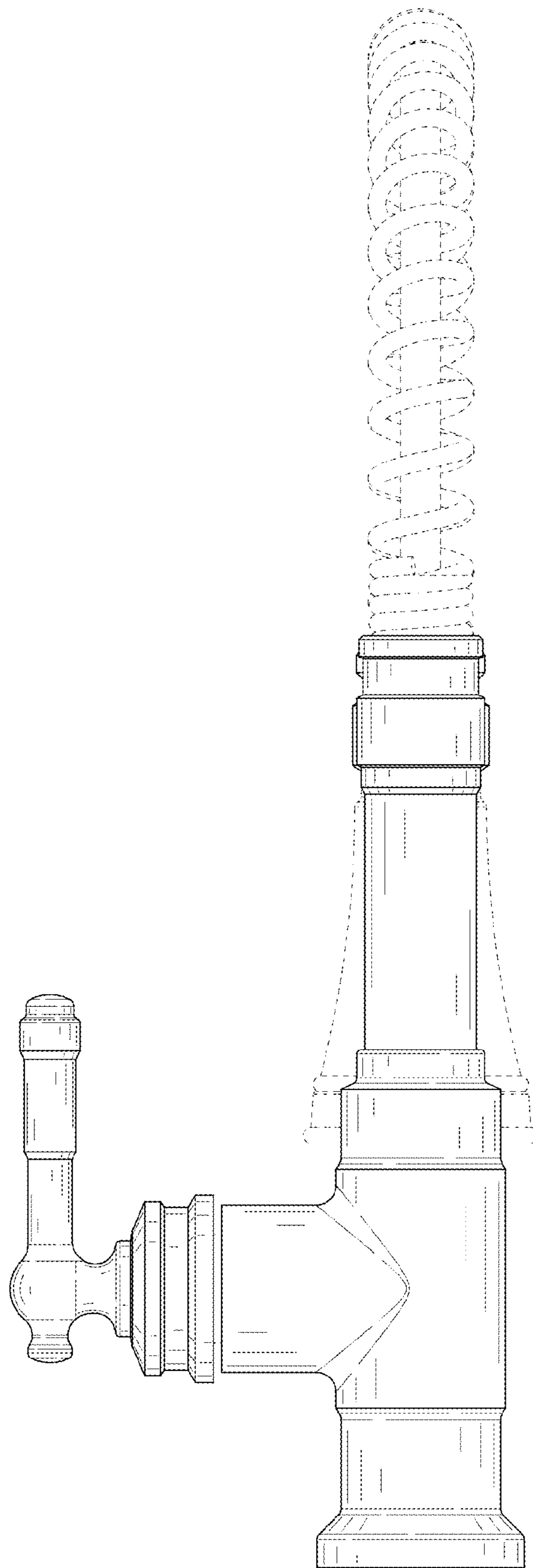

FIG. 6

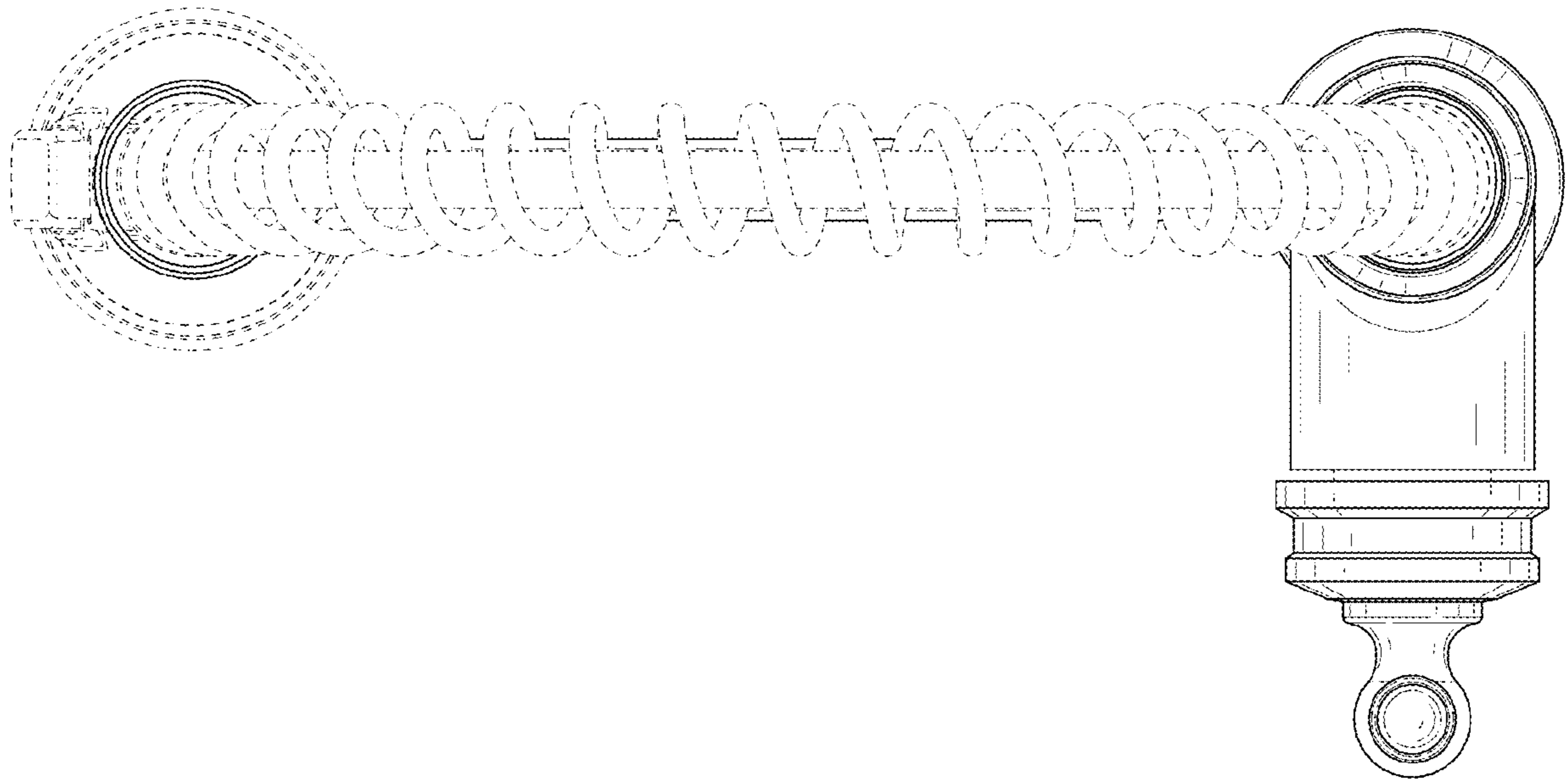

FIG. 7

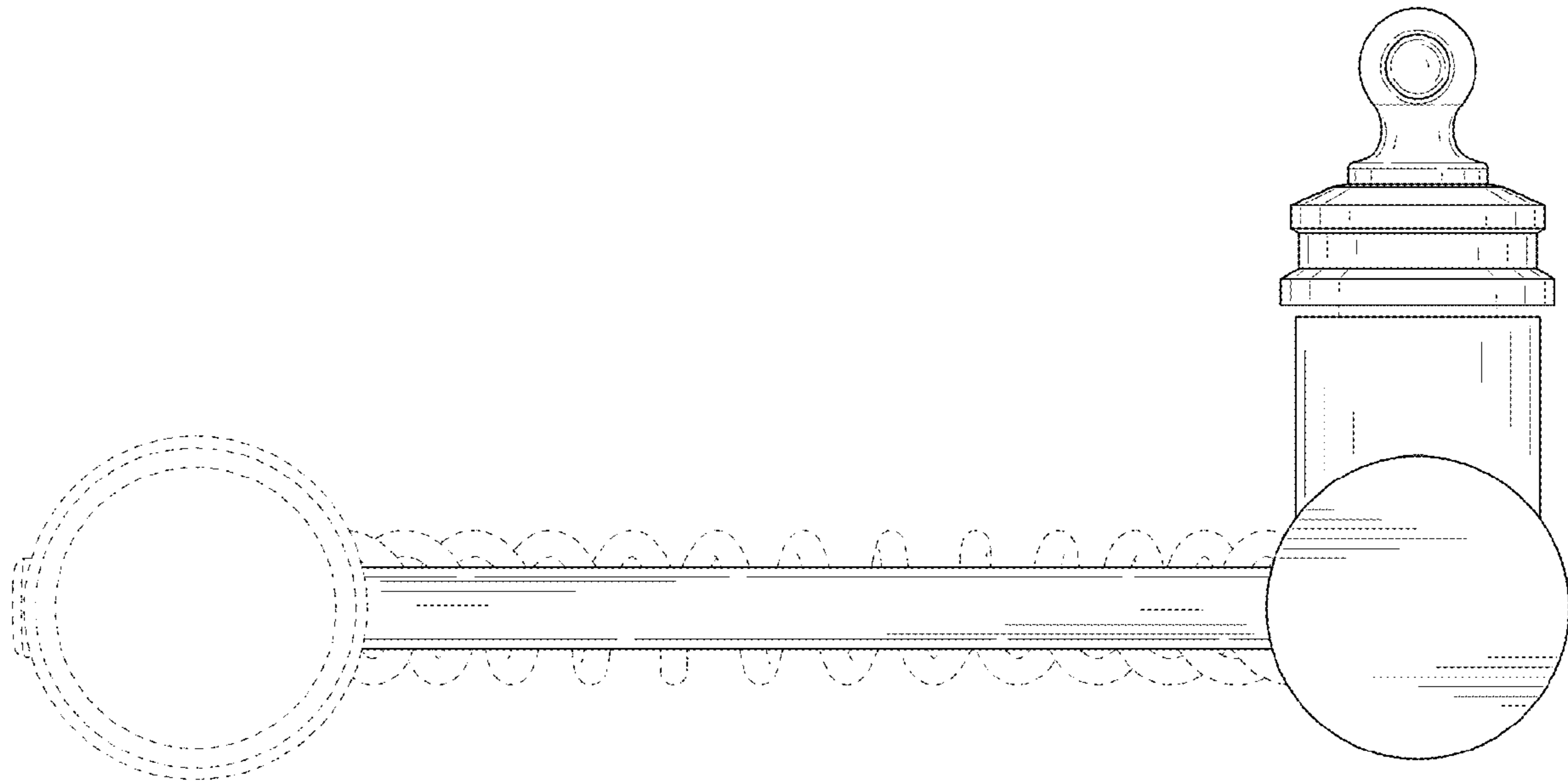

FIG. 8