



US00D975777S

(12) **United States Design Patent**
Imai et al.

(10) **Patent No.:** **US D975,777 S**
(45) **Date of Patent:** **** Jan. 17, 2023**

- (54) **FILE**
- (71) Applicant: **KENKOUSYA LTD.**, Tokyo (JP)
- (72) Inventors: **Yuhei Imai**, Tokyo (JP); **Yuzo Hayashi**, Tokyo (JP); **Hirozumi Fujiwara**, Tokyo (JP)
- (73) Assignee: **KENKOUSYA LTD.**, Tokyo (JP)
- (**) Term: **15 Years**
- (21) Appl. No.: **29/776,956**
- (22) Filed: **Apr. 1, 2021**

5,539,963 A * 7/1996 Fujiwara B42F 1/006
24/67.5
5,738,271 A * 4/1998 Hatano B42F 9/007
24/462
D400,578 S * 11/1998 Takemura D19/86
(Continued)

Primary Examiner — Calvin E Vansant
Assistant Examiner — Benjamin Lucas Gray
(74) *Attorney, Agent, or Firm* — Cermak Nakajima & McGowan LLP; Tomoko Nakajima

(57) **CLAIM**

The ornamental design for a file, as shown and described.

DESCRIPTION

- (30) **Foreign Application Priority Data**
Oct. 12, 2020 (JP) 2020-021900 D
- (51) **LOC (14) Cl.** **19-04**
- (52) **U.S. Cl.**
USPC **D19/86**; D19/26; D19/27; D19/90
- (58) **Field of Classification Search**
USPC D19/90, 26, 27, 99, 91, 33, 32, 1, 2, 65,
D19/75, 78, 86, 926
CPC B42F 1/02; B42F 1/00; B42F 13/36; B42F
13/12; B42F 15/026; B42F 9/00; B42F
9/007; B42F 11/00; B42F 21/04; B42P
2241/02; B42P 2241/08
See application file for complete search history.

FIG. 1 is a front elevational view of a file including a file main body, a slidable frame at an edge of the file main body, and a plurality of clips under the slidable frame at clip engaging portions, showing our new design;
FIG. 2 is a top plan view thereof;
FIG. 3 is a right side elevational view thereof;
FIG. 4 is a left side elevational view thereof;
FIG. 5 is a rear elevational view thereof;
FIG. 6 is a bottom plan view thereof; and
FIG. 7 is a front and top perspective view thereof.
FIG. 8 is a partially cross-sectional view thereof taken along the lines 8-8 and 8'-8' shown in FIG. 2.
FIG. 9 is an enlarged front and top perspective view of a clip of the plurality of the clips thereof;
FIG. 10 is an enlarged rear and bottom perspective view of the clip thereof;
FIG. 11 is a top view of the file main body thereof without the slidable frame and the plurality of the clips, showing the clip engaging portions and folding lines; and
FIG. 12 is a partially enlarged front and top perspective view of the edge of the main file body without the slidable frame and the clip, wherein the clip engaging portion is open along with a folding line.

(56) **References Cited**

U.S. PATENT DOCUMENTS

- 536 A * 12/1837 Ripley B42F 9/00
24/67.11
- 899,066 A * 9/1908 Pein B42F 13/12
402/64
- D159,645 S * 8/1950 Knorr D19/83
- 4,493,495 A * 1/1985 Linn B42F 9/00
24/535
- D310,098 S * 8/1990 Ristuccia, Sr. D19/1
- D314,977 S * 2/1991 Wyant D19/27

1 Claim, 12 Drawing Sheets

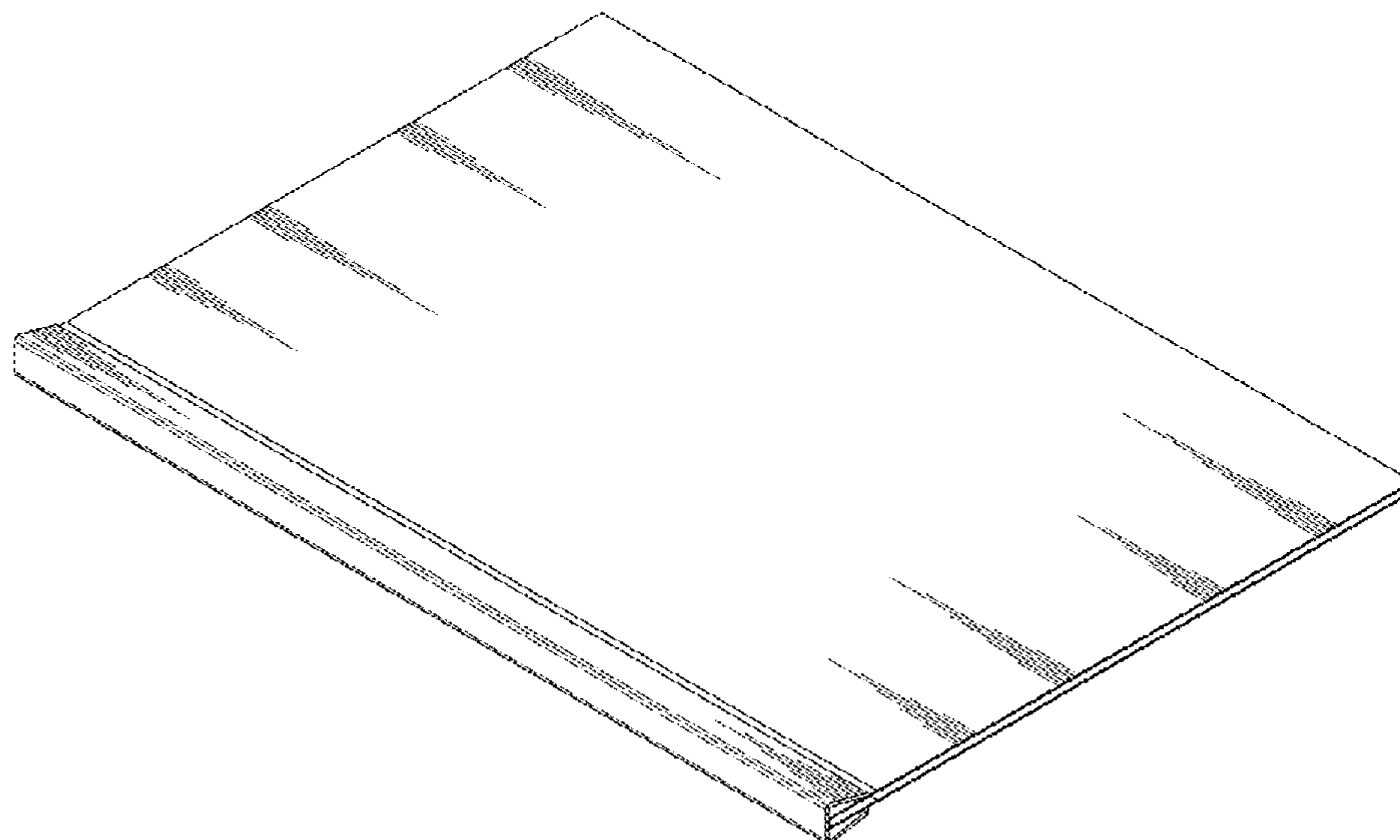

(56)

References Cited

U.S. PATENT DOCUMENTS

6,964,537 B1 * 11/2005 Ong B42F 9/007
402/80 R
D712,474 S * 9/2014 Gingell D19/86
D788,222 S * 5/2017 Klosky D19/26
2002/0113427 A1 * 8/2002 Nada B42F 9/00
281/45
2005/0047894 A1 * 3/2005 Merkli B31F 5/00
412/33
2016/0107470 A1 * 4/2016 Peleman B42D 3/002
281/21.1
2021/0379922 A1 * 12/2021 Vartak B42F 7/02

* cited by examiner

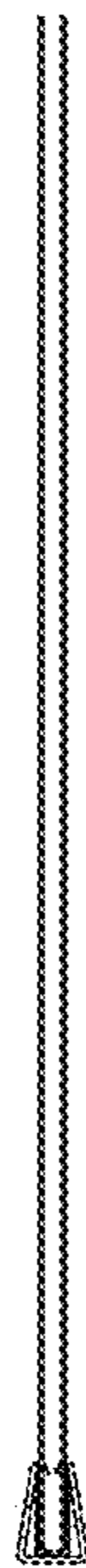

FIG.1

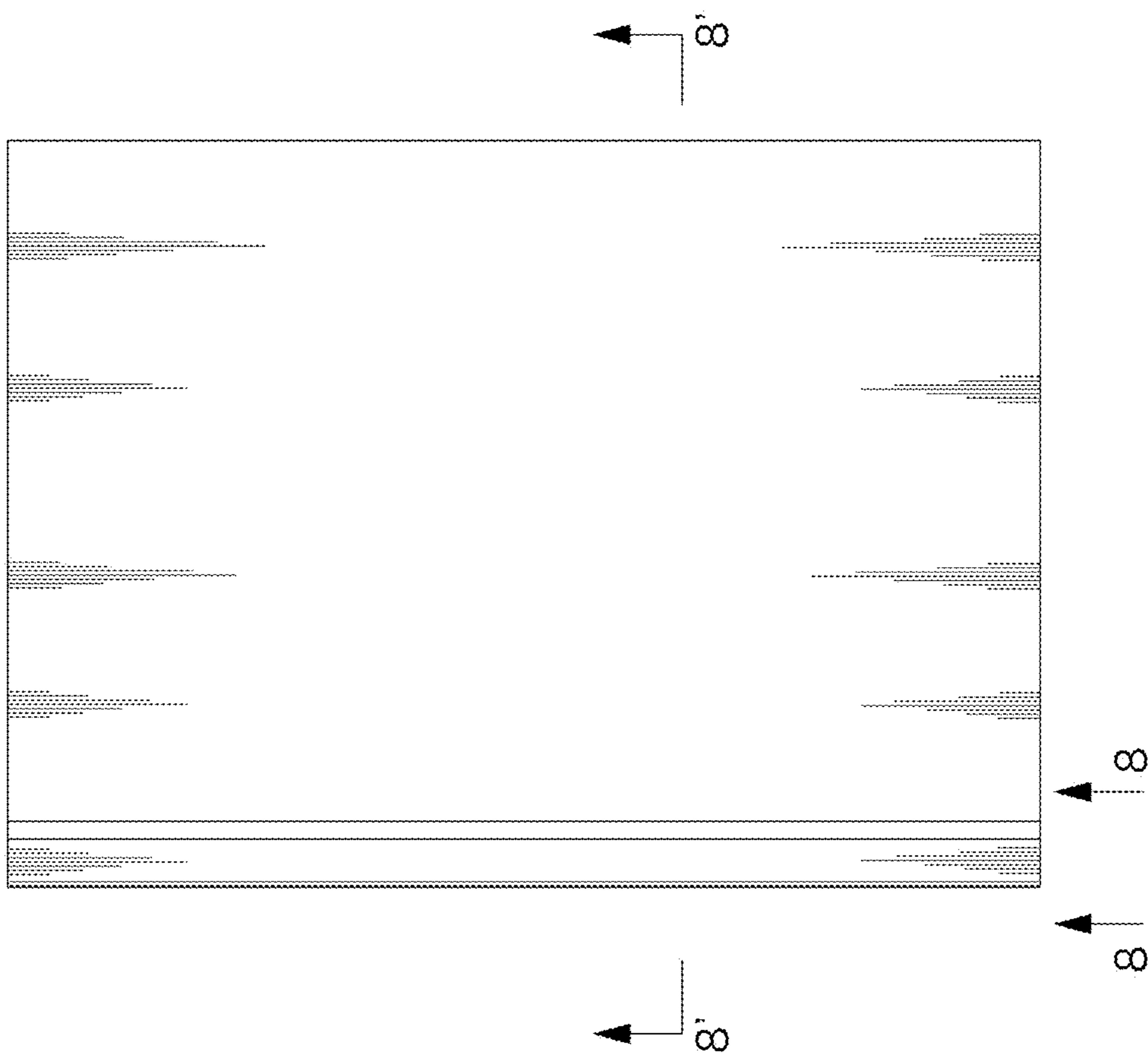

FIG. 2



FIG.3



FIG. 4

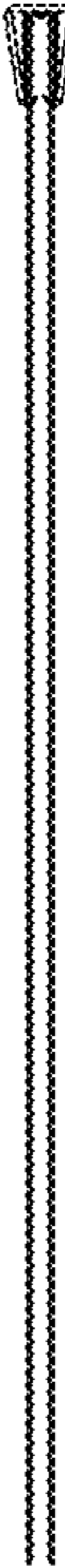

FIG.5

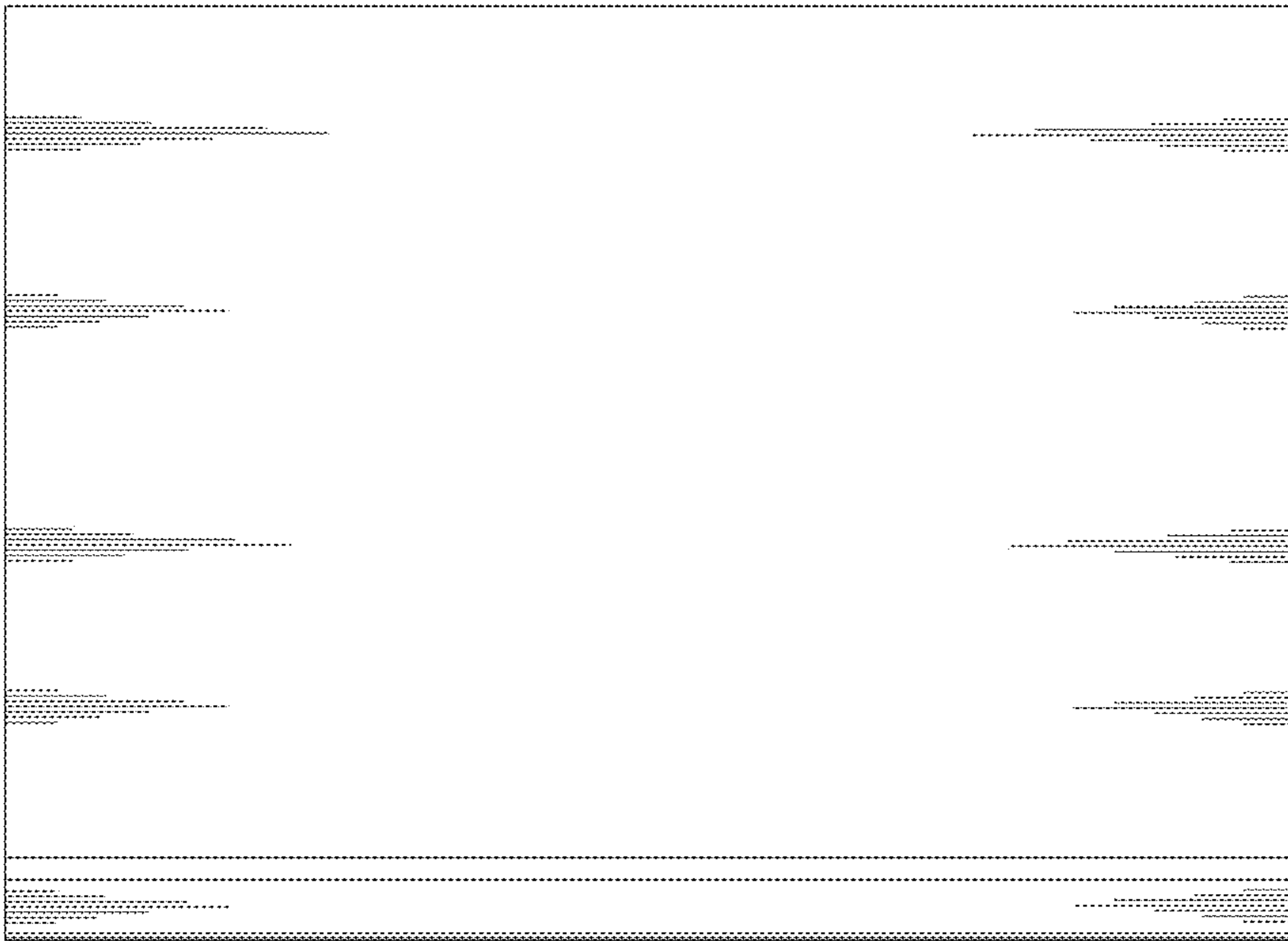

FIG.6

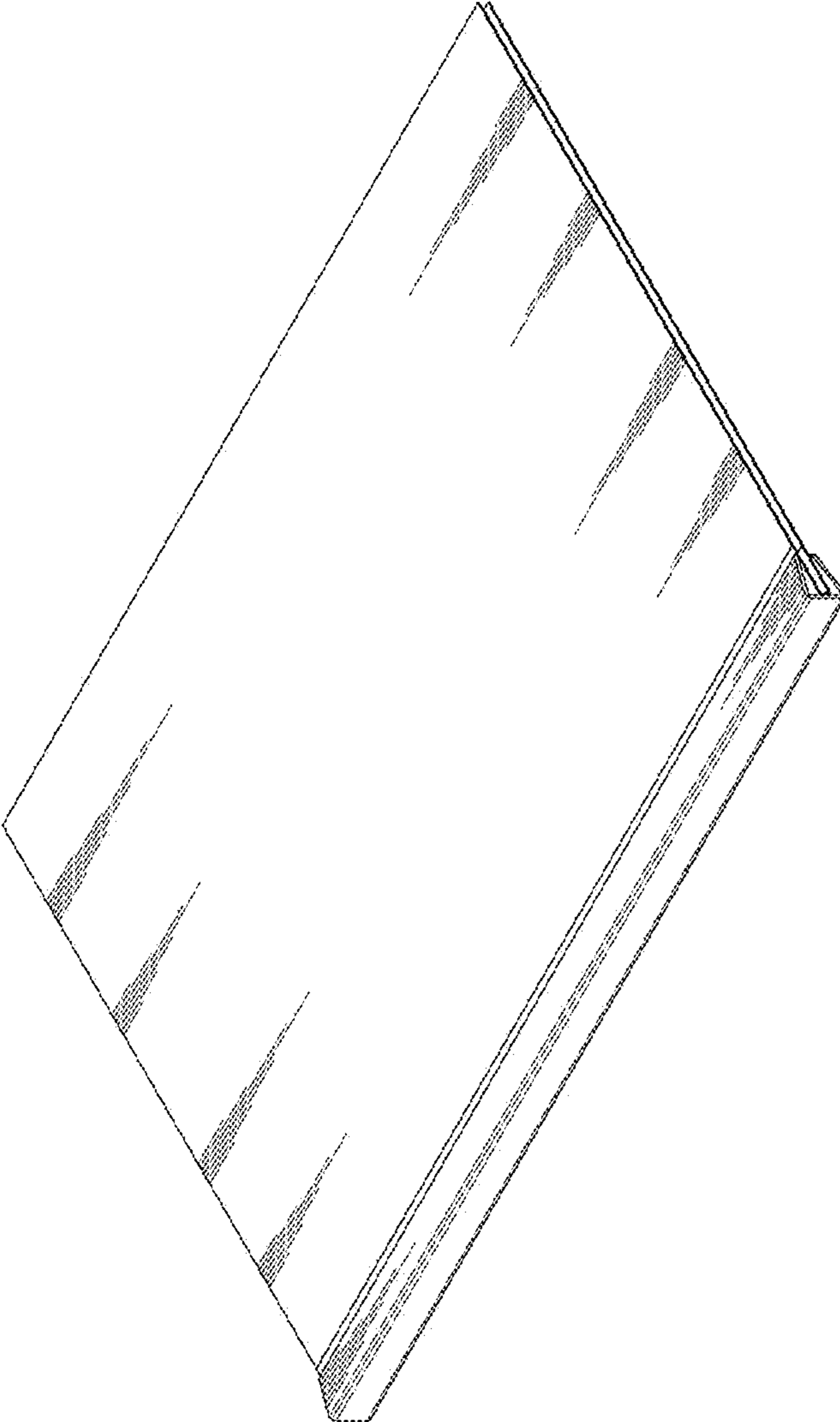

FIG.7

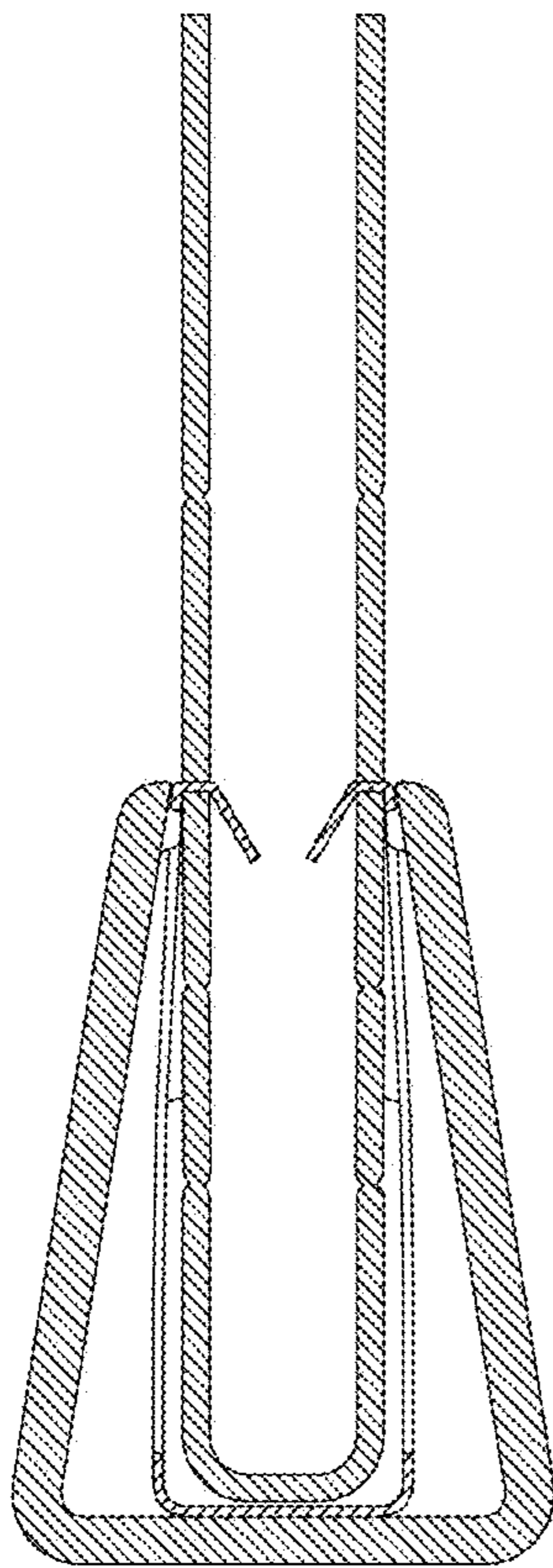

FIG.8

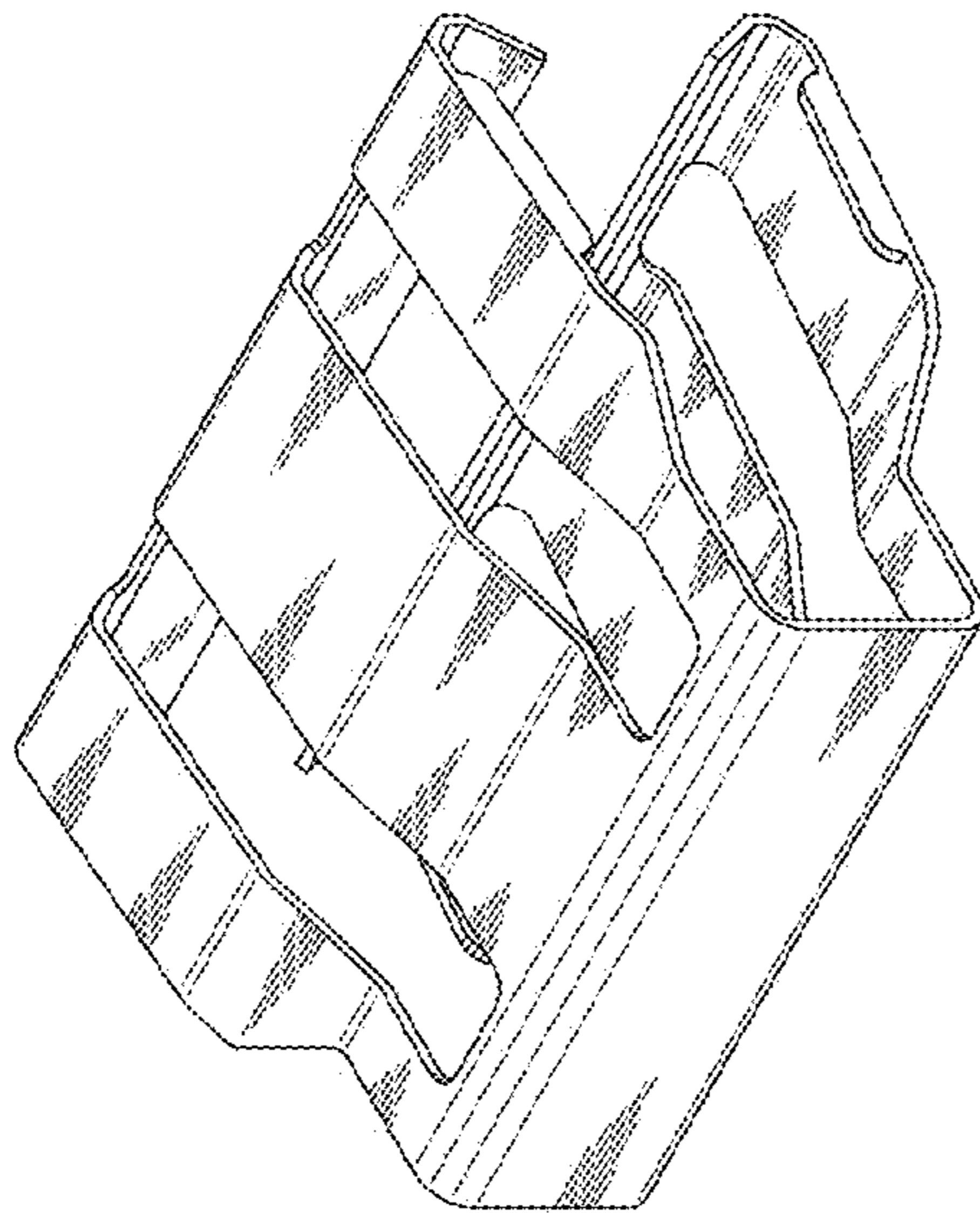

FIG.9

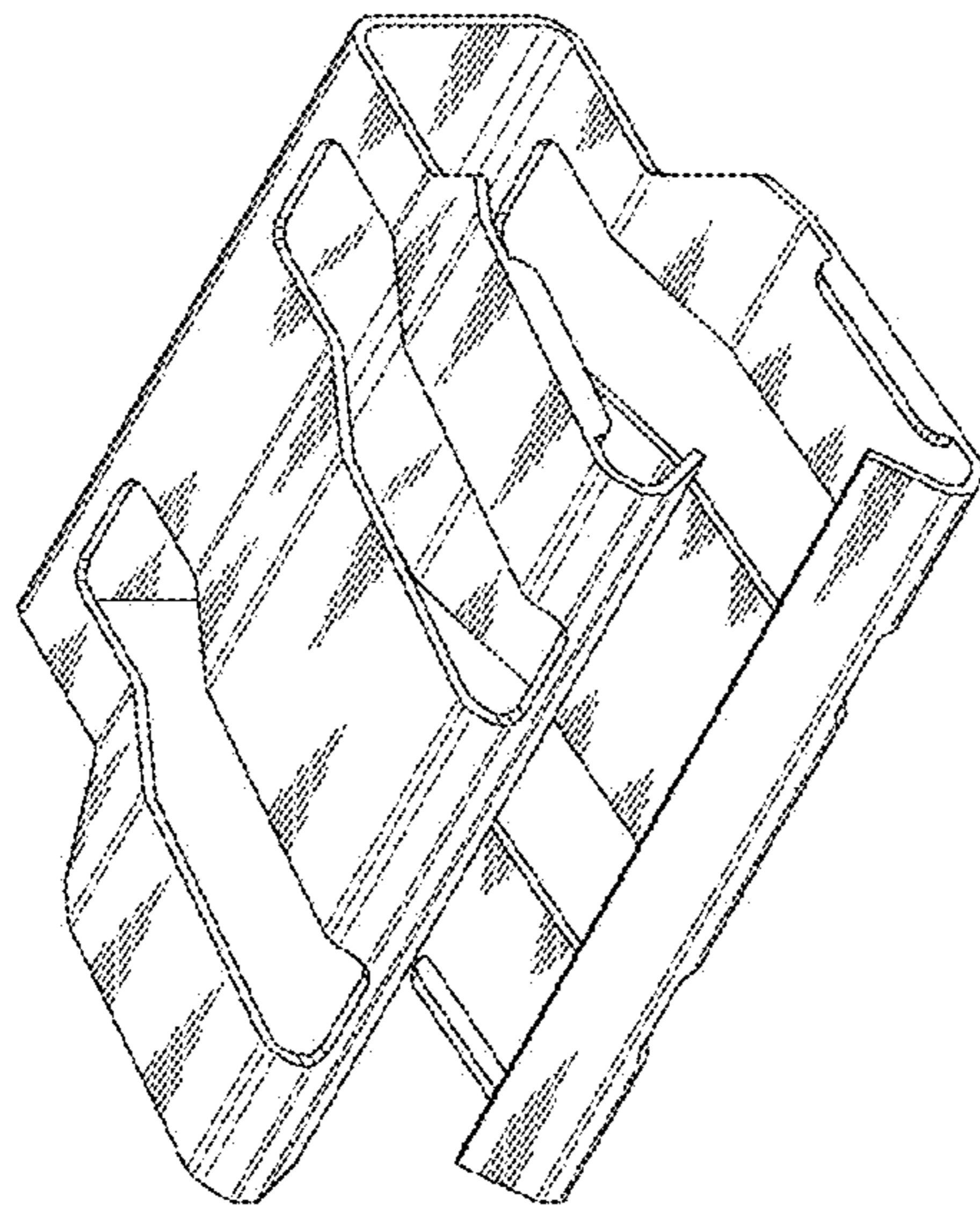

FIG.10

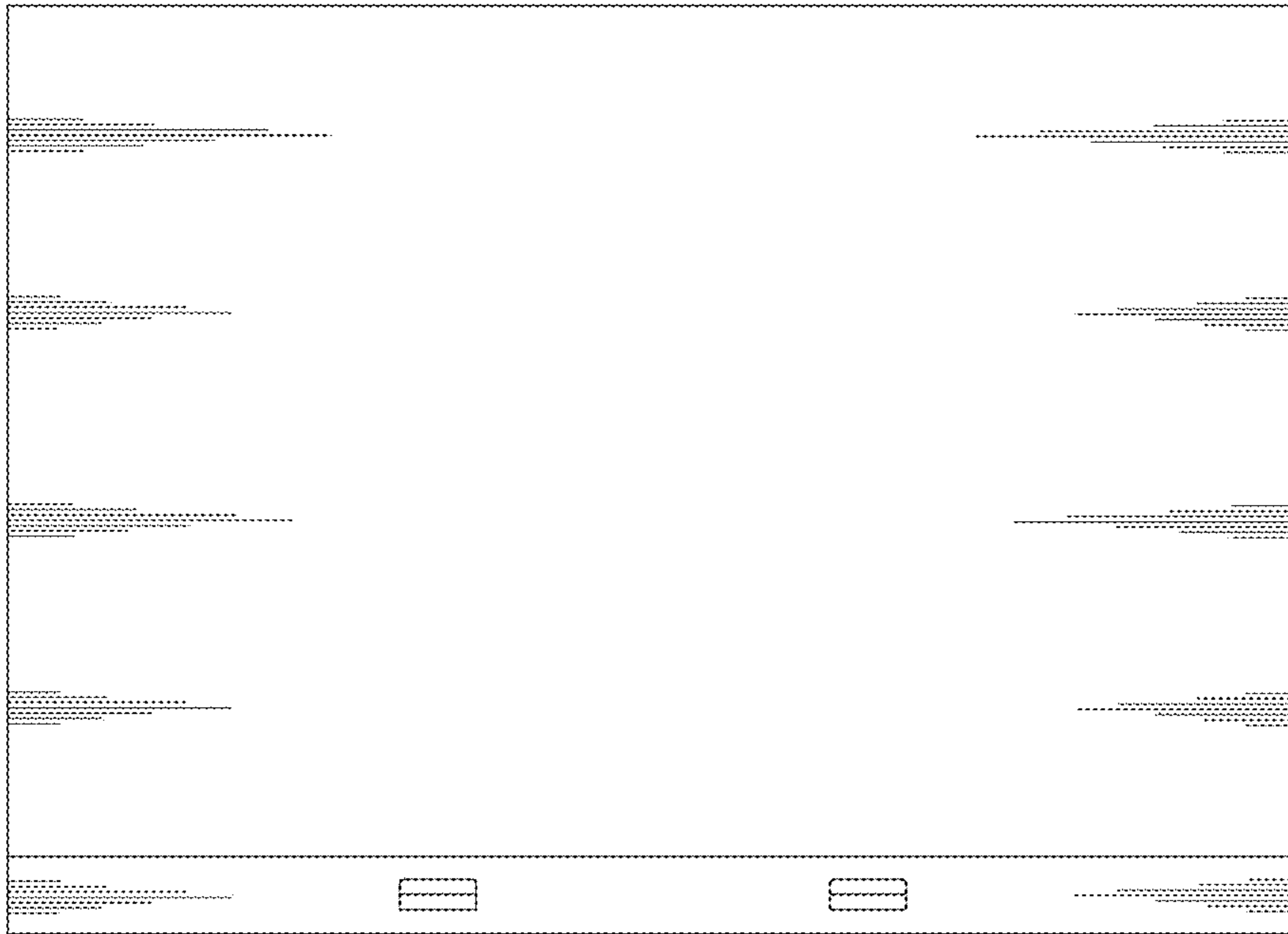

FIG.11

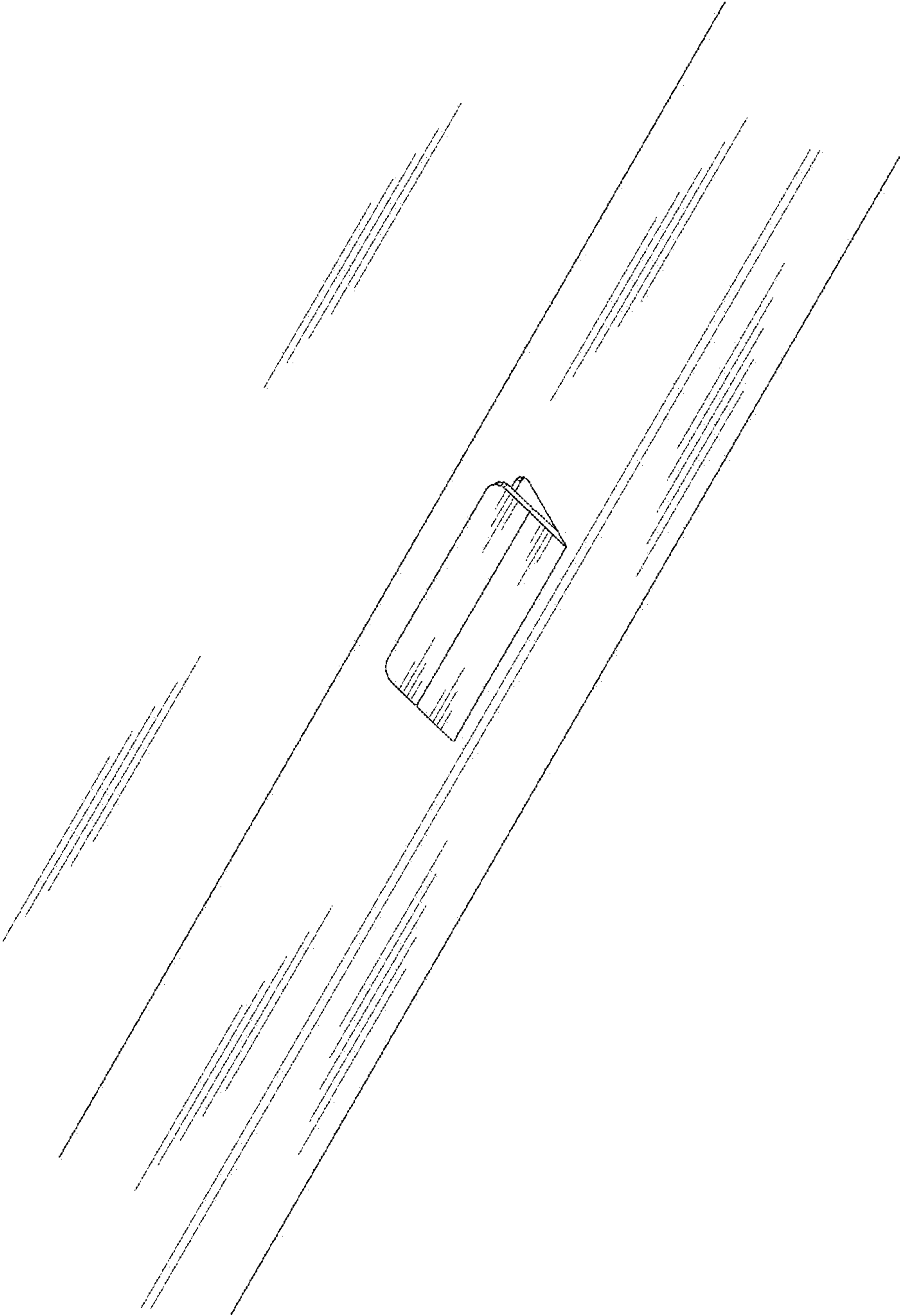

FIG.12