

US00D975772S

(12) **United States Design Patent**
Zhang

(10) **Patent No.:** **US D975,772 S**

(45) **Date of Patent:** **** Jan. 17, 2023**

(54) **DASHBOARD CAMERA**

(71) Applicant: **Shenzhen Linrui Trading Co., Ltd.**,
Guangdong (CN)

(72) Inventor: **Lin Zhang**, Jiangxi (CN)

(73) Assignee: **Shenzhen Linrui Trading Co., Ltd.**,
Shenzhen (CN)

(**) Term: **15 Years**

(21) Appl. No.: **29/854,431**

(22) Filed: **Sep. 23, 2022**

(51) **LOC (14) Cl.** **16-01**

(52) **U.S. Cl.**
USPC **D16/208**

(58) **Field of Classification Search**

USPC D16/200, 202-208, 218, 219, 242
CPC G03B 17/02; G03B 19/04; G03B 17/56;
G03B 17/04; G03B 15/03; H04N 5/2251;
H04N 5/2252; H04N 5/2253; H04N
5/2254; H04N 7/181; H04N 7/183; H04N
7/18

See application file for complete search history.

(56) **References Cited**

U.S. PATENT DOCUMENTS

D366,271 S * 1/1996 Hasegawa D16/203
D748,712 S * 2/2016 Tompkin D16/218

D782,560 S 3/2017 Li
D858,610 S * 9/2019 Fang D16/218
D861,764 S 10/2019 Zhao
D866,639 S * 11/2019 Fang D16/208
D875,803 S * 2/2020 Yuan D16/202
D875,812 S * 2/2020 Zhang D16/218
D888,126 S * 6/2020 Lee D16/202
D888,127 S * 6/2020 Lee D16/202
D896,295 S * 9/2020 Lee D16/202
D966,390 S * 10/2022 Zhang D16/202
D968,496 S * 11/2022 Long D16/208

* cited by examiner

Primary Examiner — Ramzi Almatrahi

(57) **CLAIM**

The ornamental design for a dashboard camera, as shown and described.

DESCRIPTION

FIG. 1 is a top, front and right side perspective view of a dashboard camera, showing my new design;
FIG. 2 is a bottom, back and left side perspective view thereof;
FIG. 3 is a front elevational view thereof;
FIG. 4 is a back elevational view thereof;
FIG. 5 is a left side elevational view thereof;
FIG. 6 is a right side elevational view thereof;
FIG. 7 is a top plan view thereof; and,
FIG. 8 is a bottom plan view thereof.

1 Claim, 8 Drawing Sheets

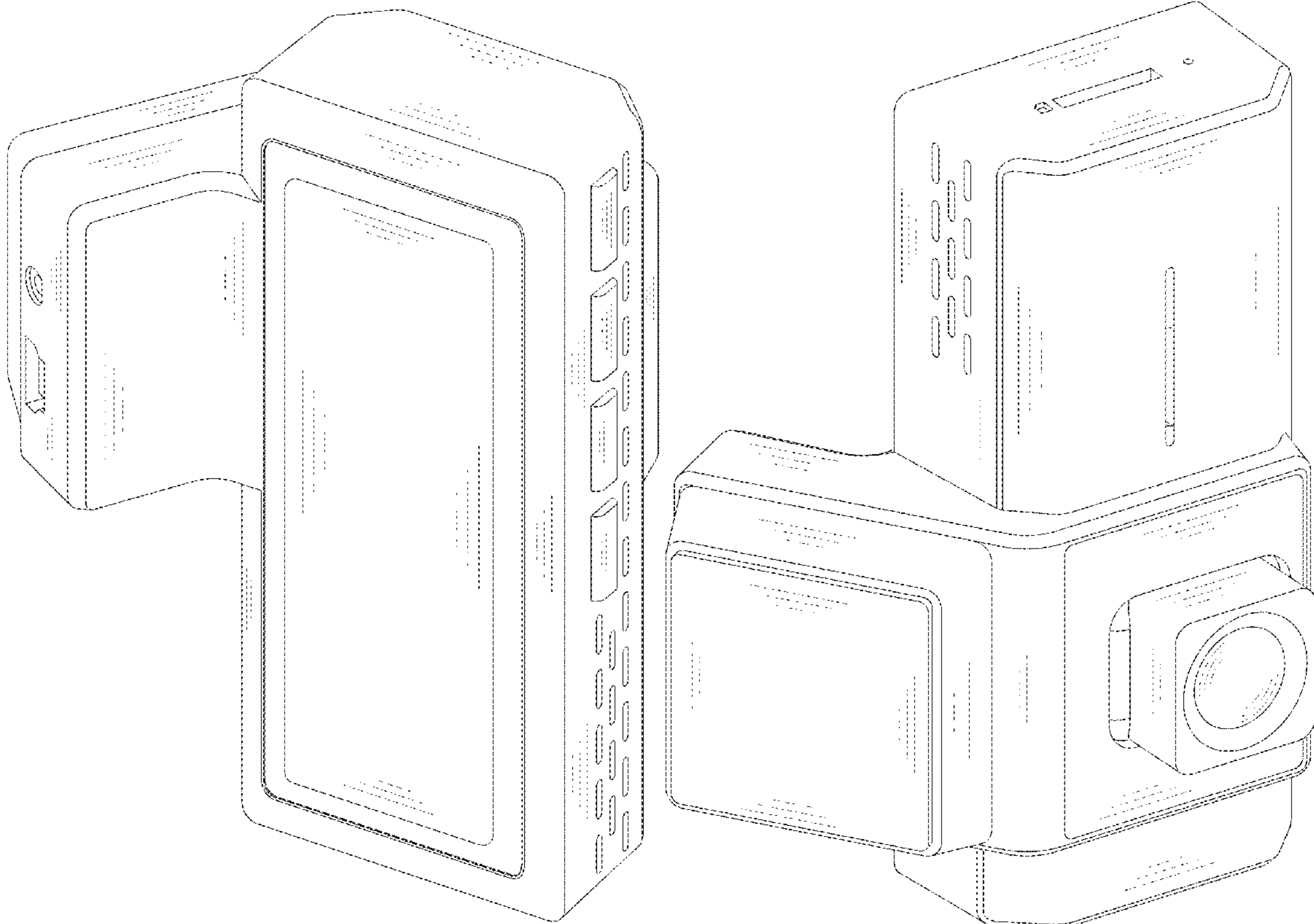

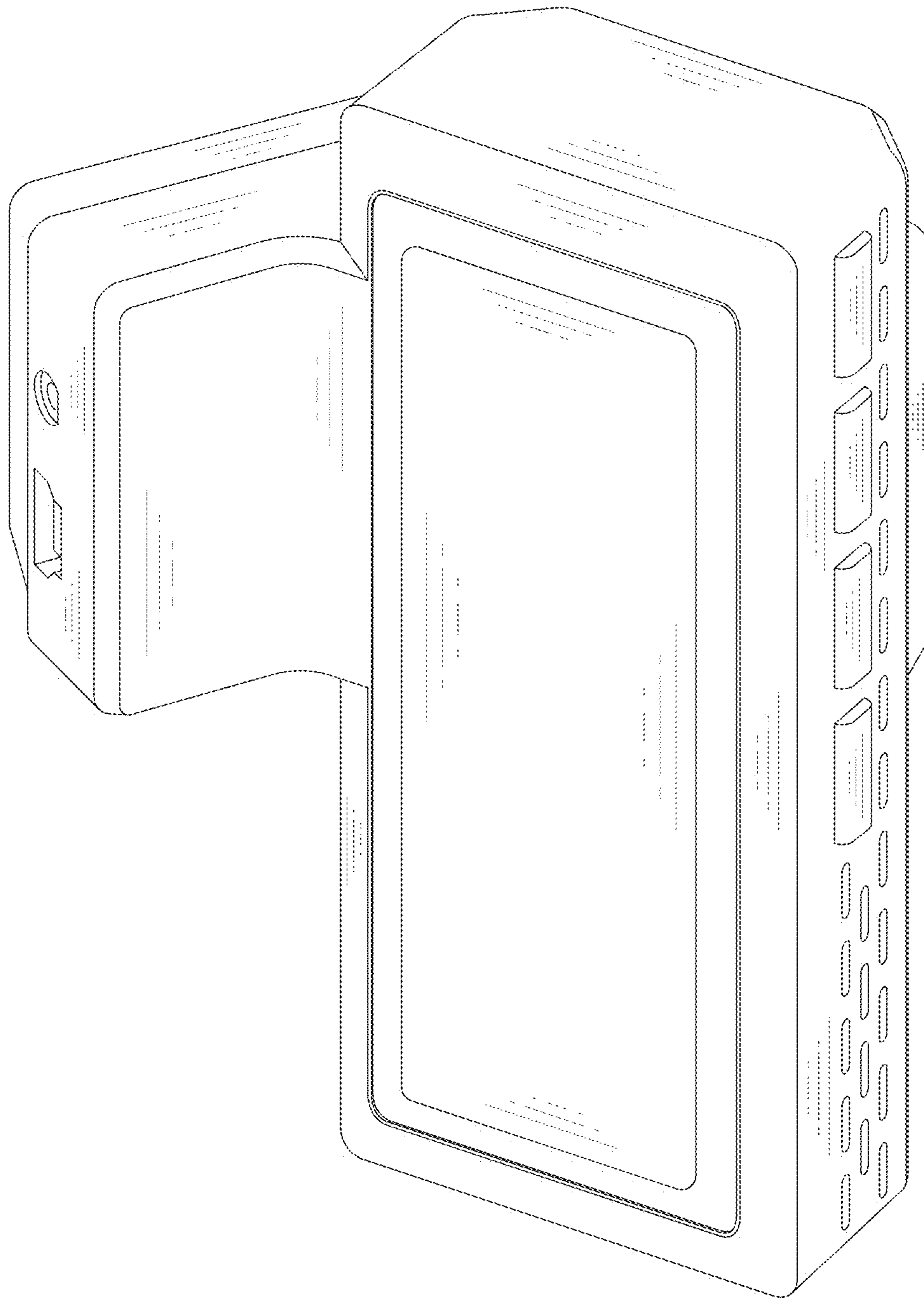

FIG. 1

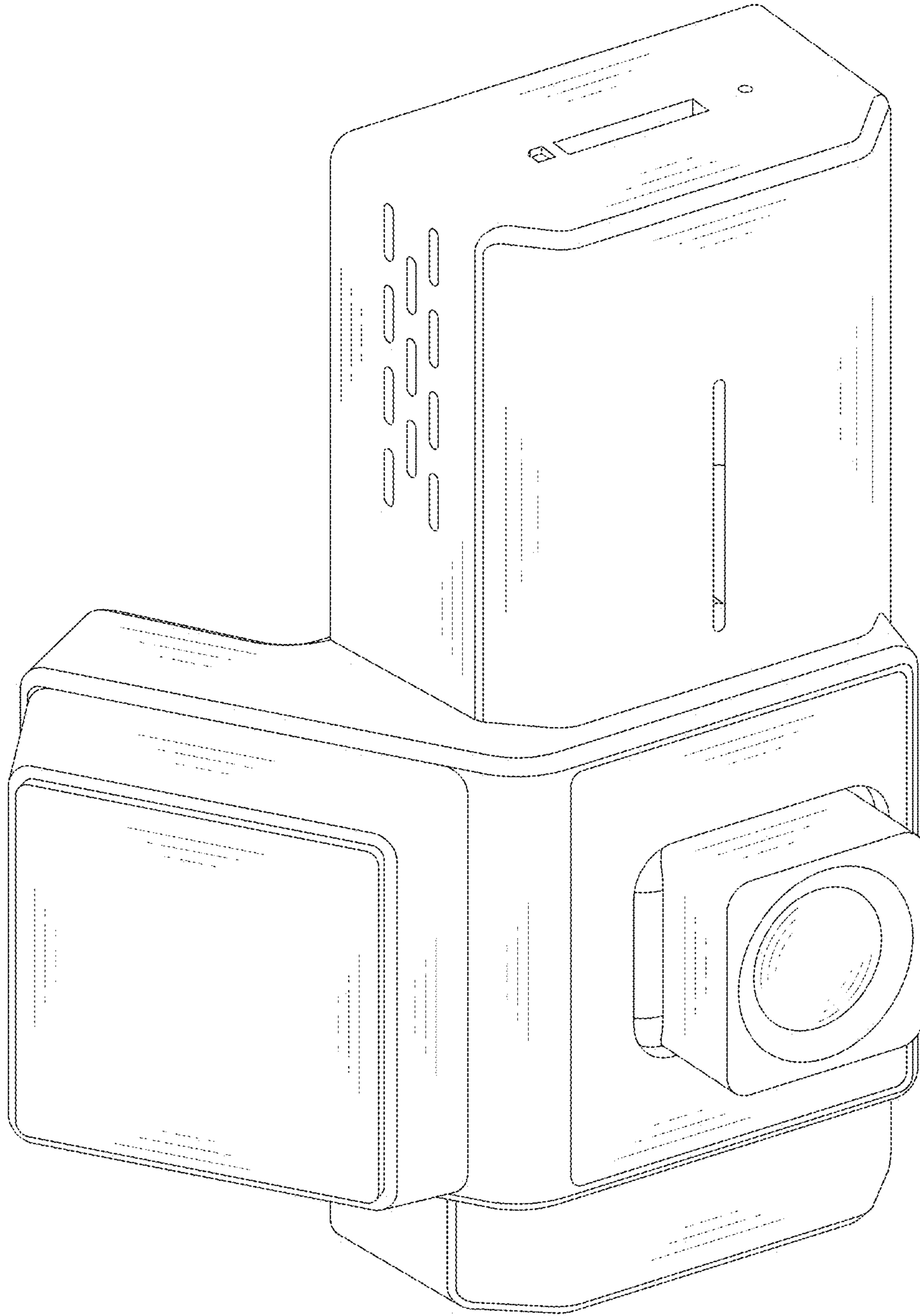

FIG. 2

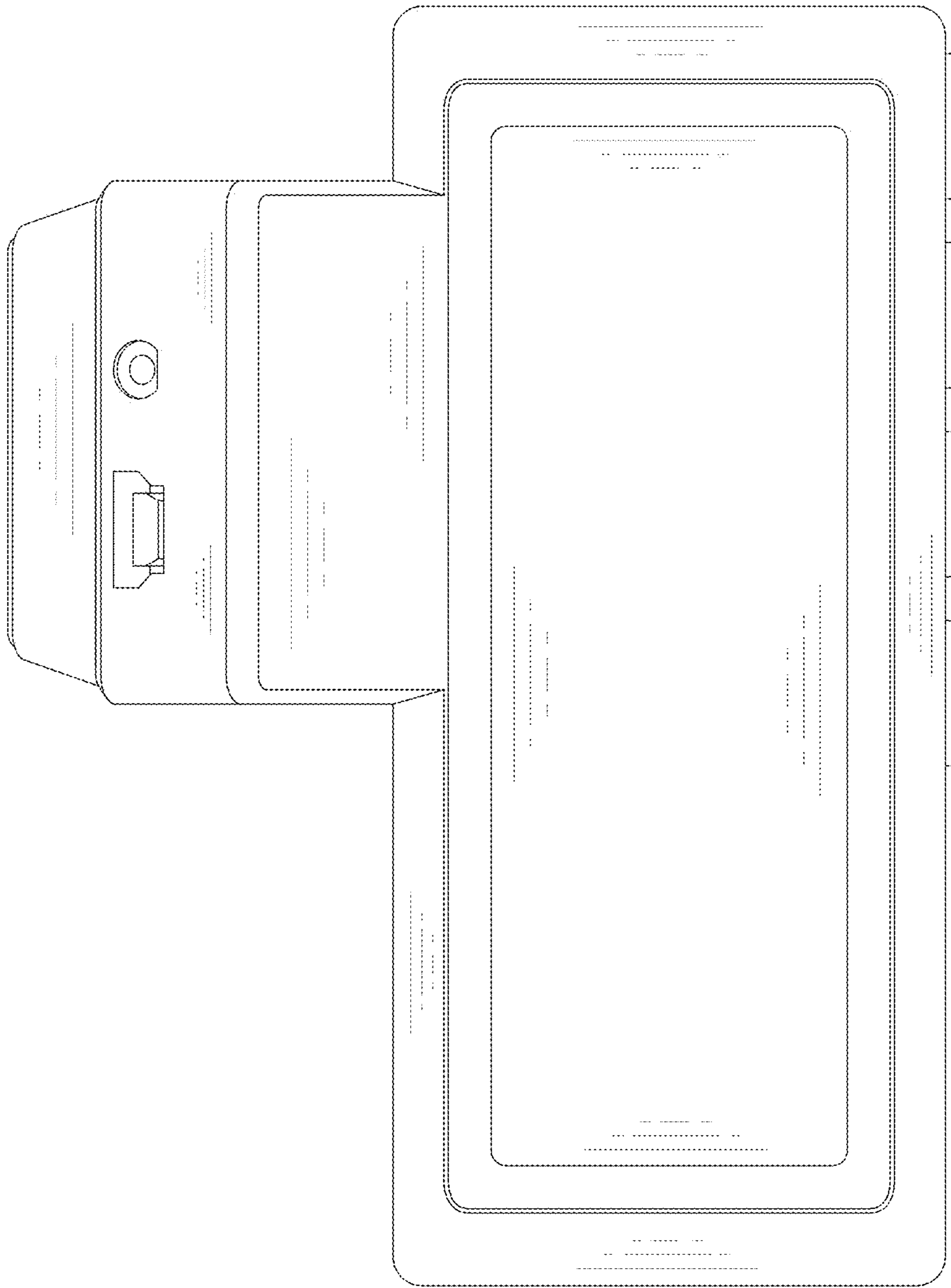

FIG. 3

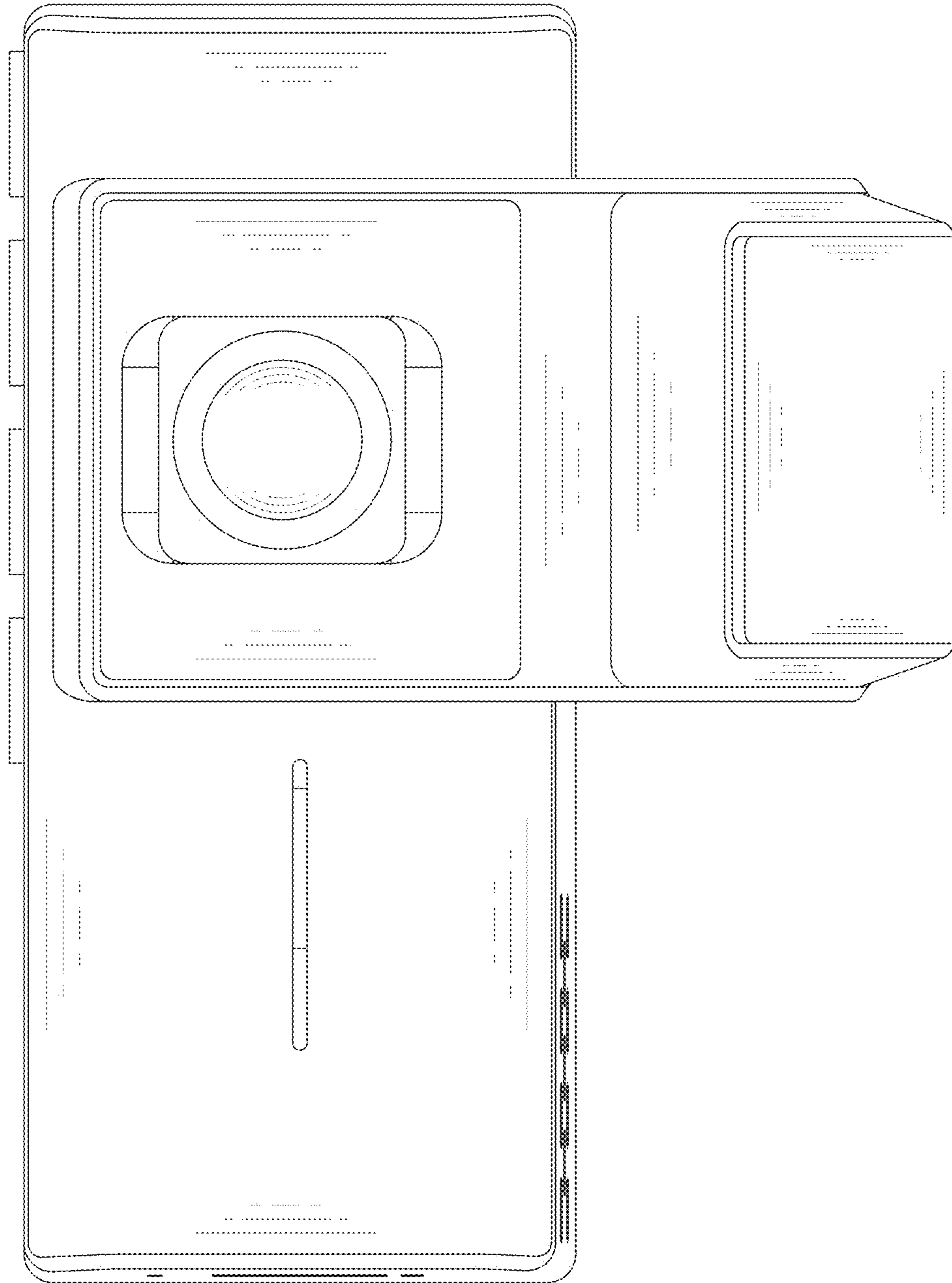

FIG. 4

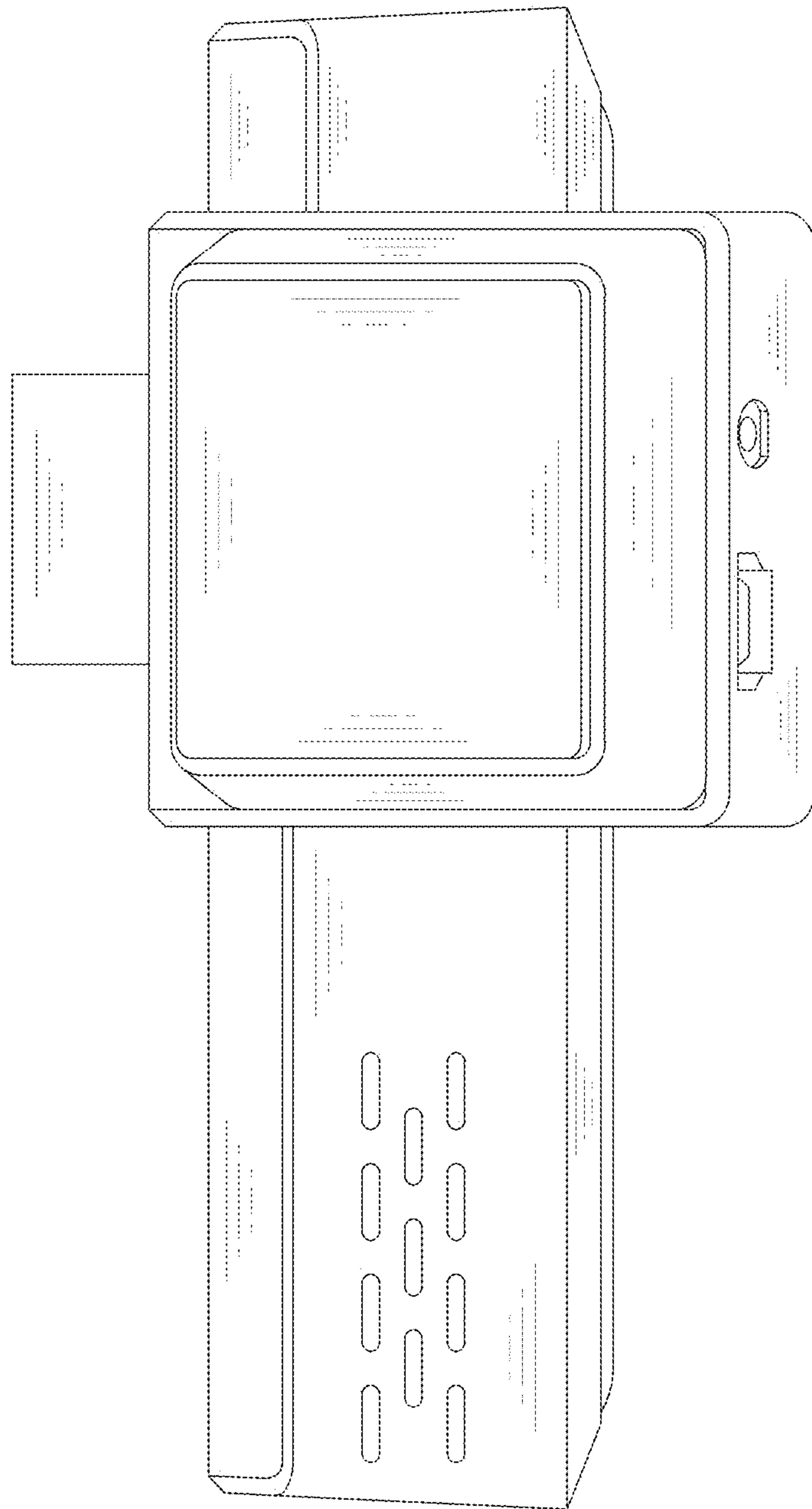

FIG. 5

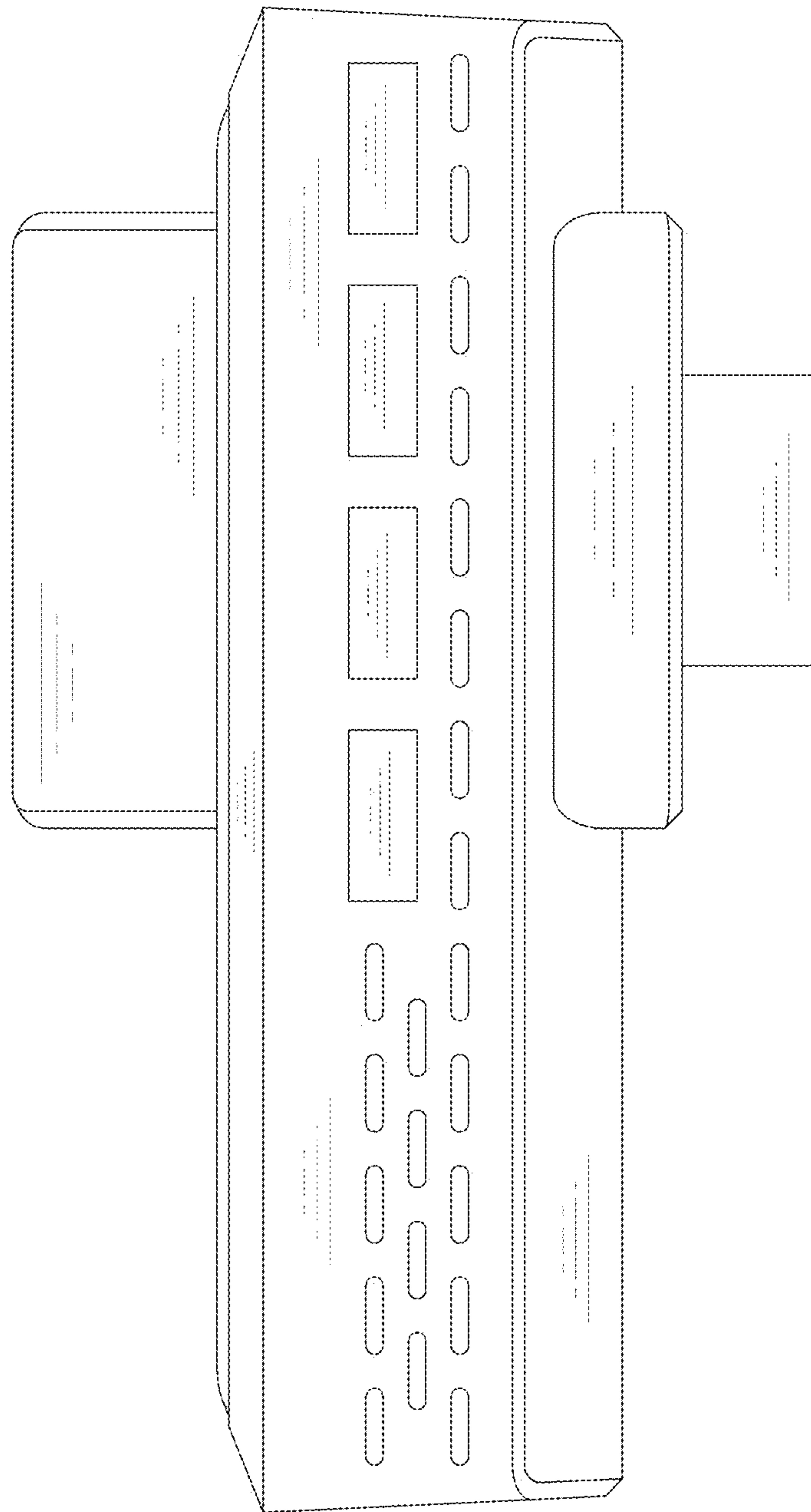

FIG. 6

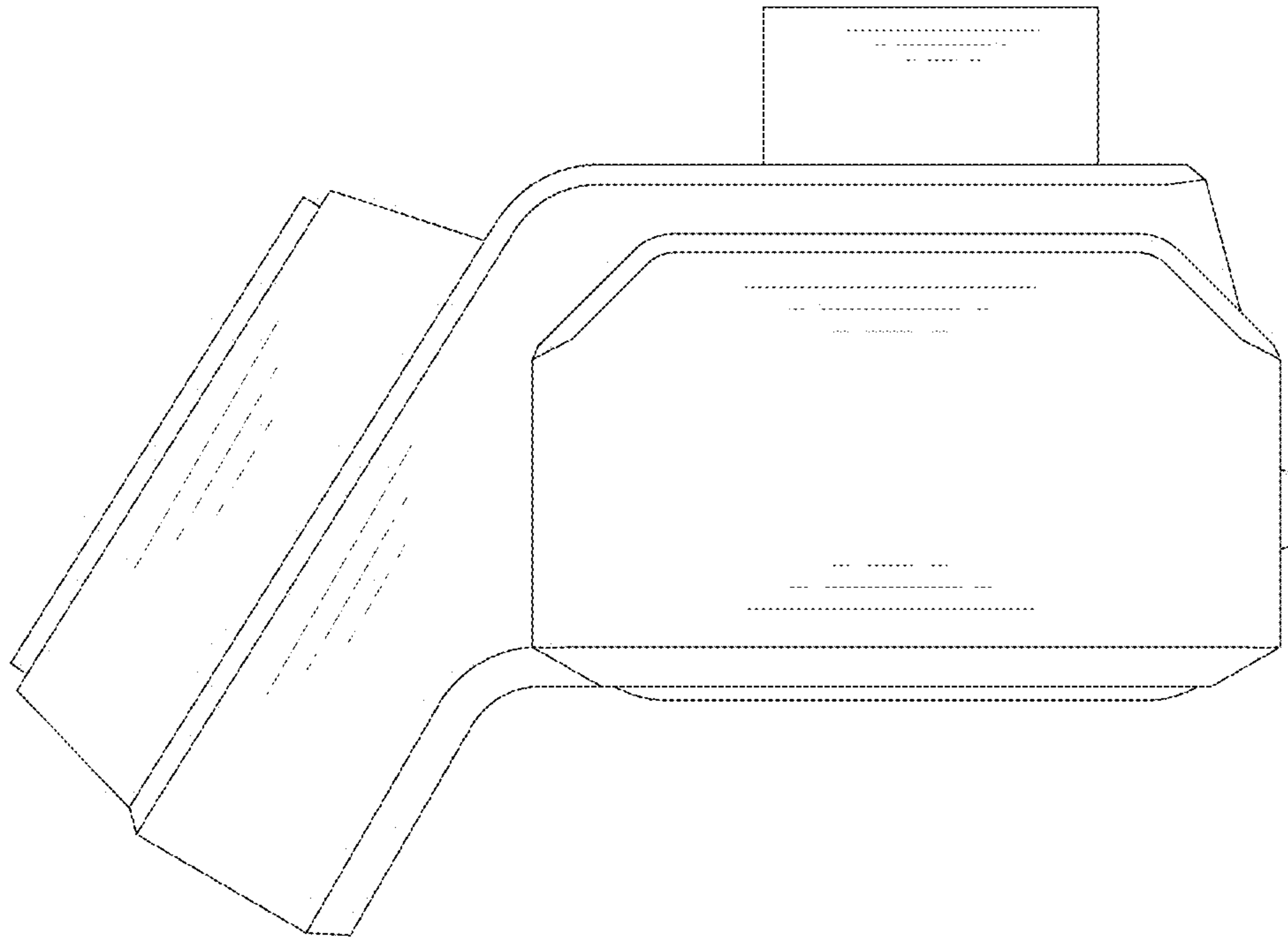

FIG. 7

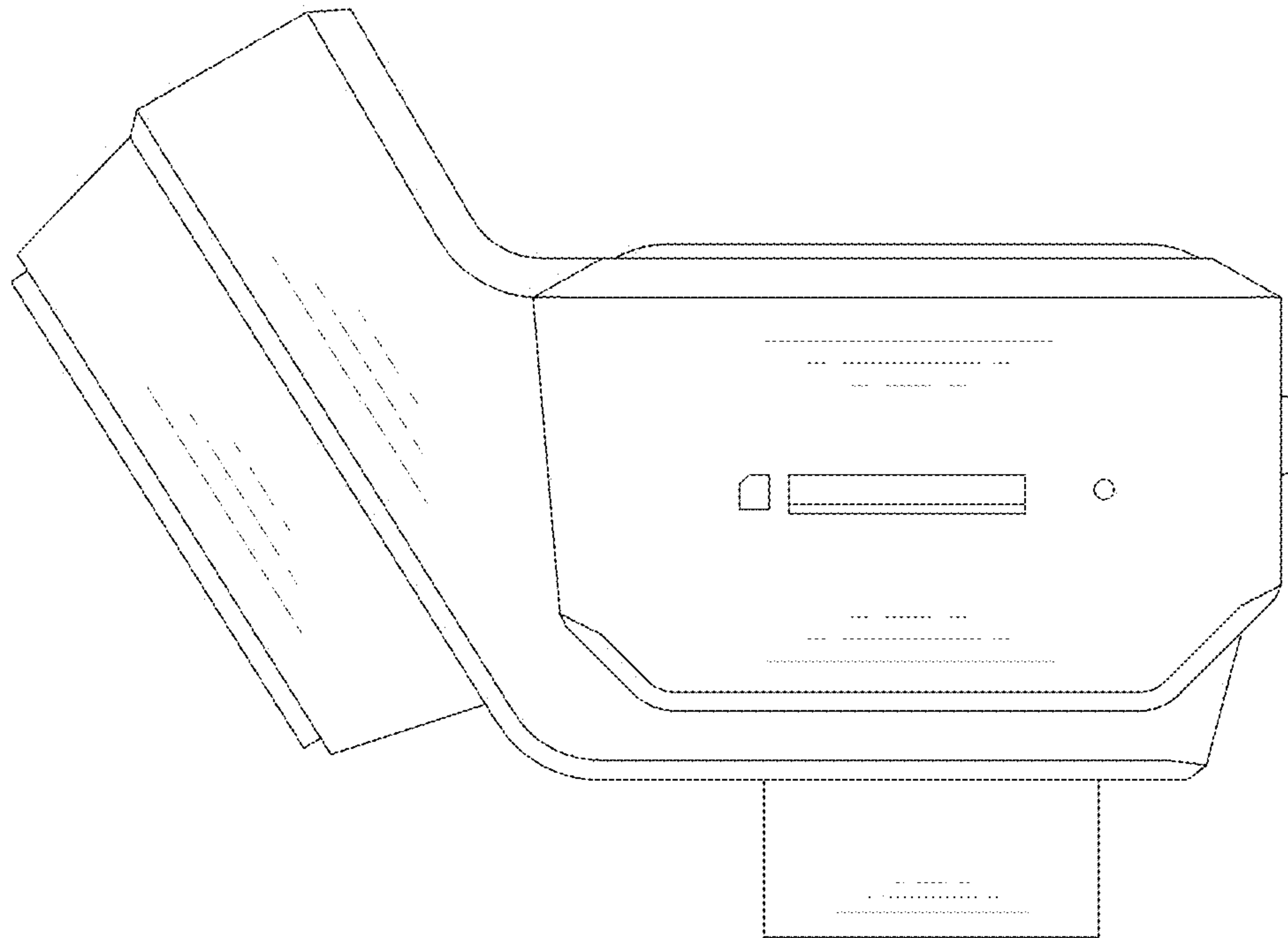

FIG. 8