



US00D975670S

(12) **United States Design Patent**
He

(10) **Patent No.:** **US D975,670 S**

(45) **Date of Patent:** **** Jan. 17, 2023**

(54) **HEADPHONE AMPLIFIER**

(56) **References Cited**

(71) Applicants: **Guangzhou Rantion Technology Co., Ltd.**, Guangzhou (CN); **Donner Technology LLC**, Charlotte, NC (US)

U.S. PATENT DOCUMENTS

(72) Inventor: **Naiyong He**, Guangzhou (CN)

| | | | |
|--------------|---------|----------------|-----------|
| D342,948 S * | 1/1994 | Furui | D14/210 |
| D398,304 S * | 9/1998 | Murray | D14/137 |
| D412,705 S * | 8/1999 | Laiacona | D14/214 |
| D429,717 S * | 8/2000 | Kizawa | D14/215 |
| D510,338 S * | 10/2005 | Brimhall | D14/214 |
| D532,425 S * | 11/2006 | Kim | D14/203.7 |
| D552,076 S * | 10/2007 | Griffin | D14/188 |
| D683,714 S * | 6/2013 | Ito | D14/167 |
| D746,254 S * | 12/2015 | Ito | D14/188 |
| D762,614 S * | 8/2016 | Matsui | D14/188 |
| D773,432 S * | 12/2016 | Rowan | D14/188 |
| D952,603 S * | 5/2022 | Wen | D14/225 |

(**) Term: **15 Years**

(21) Appl. No.: **29/794,291**

(22) Filed: **Jun. 11, 2021**

(51) **LOC (14) Cl.** **14-03**

* cited by examiner

(52) **U.S. Cl.**
USPC **D14/188**

Primary Examiner — Keli L Hill

(58) **Field of Classification Search**
 USPC D14/167, 168, 170–172, 188, 194–197,
 D14/203.1–203.8, 204, 209.1, 210–217,
 D14/219, 221, 222, 224, 239, 496
 CPC B60R 11/0217; G06F 1/1688; G10K 9/22;
 G10K 11/004; H03F 1/327; H04M 1/03;
 H04M 1/035; H04N 5/642; H04N
 21/4852; H04R 1/02; H04R 1/06; H04R
 1/021; H04R 1/025; H04R 1/026; H04R
 1/028; H04R 1/105; H04R 1/323; H04R
 1/403; H04R 1/2803; H04R 1/2834;
 H04R 5/02; H04R 7/20; H04R 9/06;
 H04R 9/025; H04R 2201/021; H04R
 2400/00; H04R 2400/07; H04R 2499/11;
 H04R 2499/13; H04R 2499/15; H04S
 3/00; H04S 7/30

(57) **CLAIM**

The ornamental design for a headphone amplifier, as shown and described.

DESCRIPTION

FIG. 1 is a front and top perspective view of a headphone amplifier, showing my new design;
 FIG. 2 is a rear and bottom perspective view thereof;
 FIG. 3 is a front elevation view thereof;
 FIG. 4 is a rear elevation view thereof;
 FIG. 5 is a left side elevation view thereof;
 FIG. 6 is a right side elevation view thereof;
 FIG. 7 is a top plan view thereof; and,
 FIG. 8 is a bottom plan view thereof.
 The broken lines in the figures illustrate portions of the headphone amplifier that form no part of the claimed design.

See application file for complete search history.

1 Claim, 8 Drawing Sheets

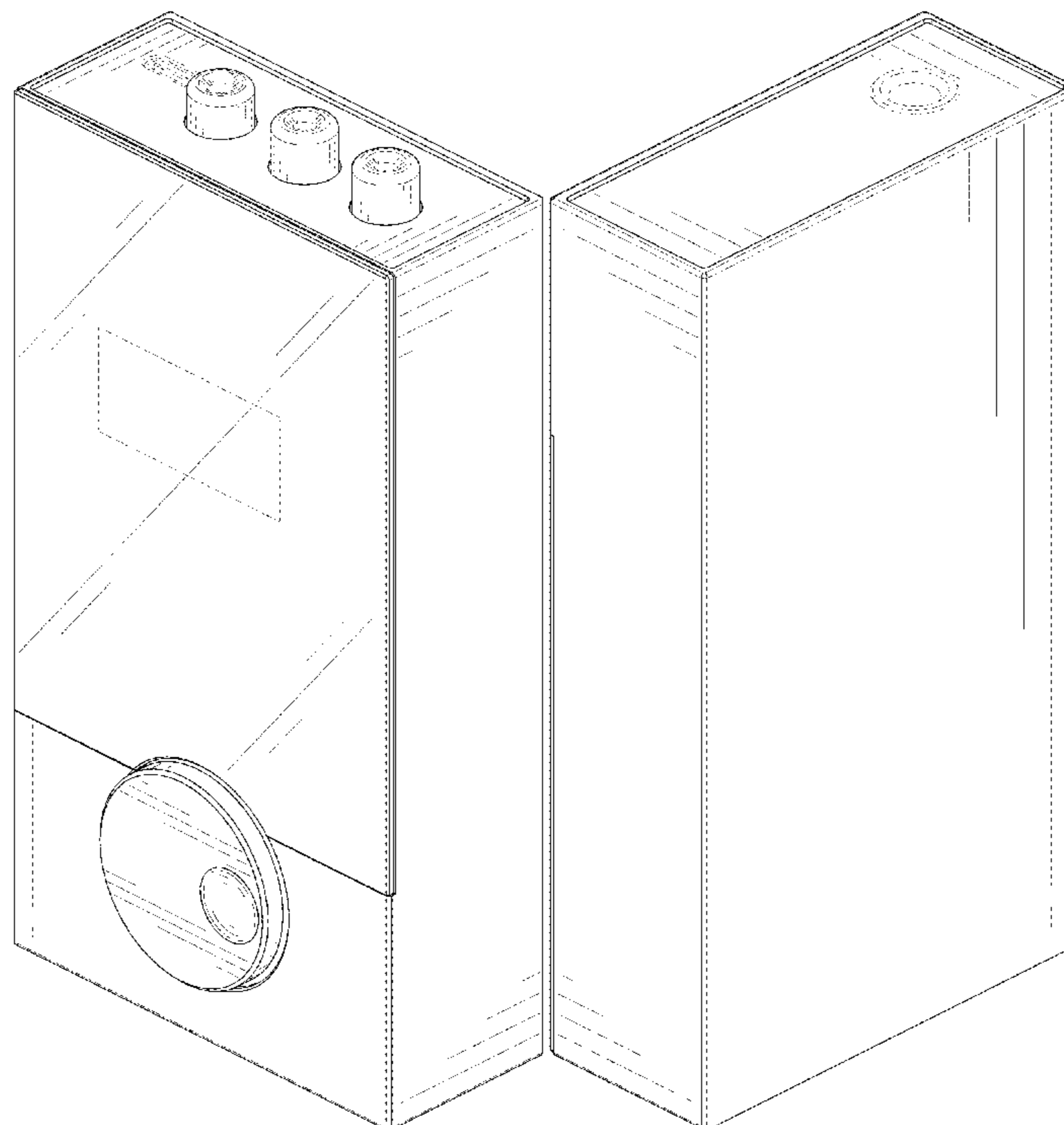

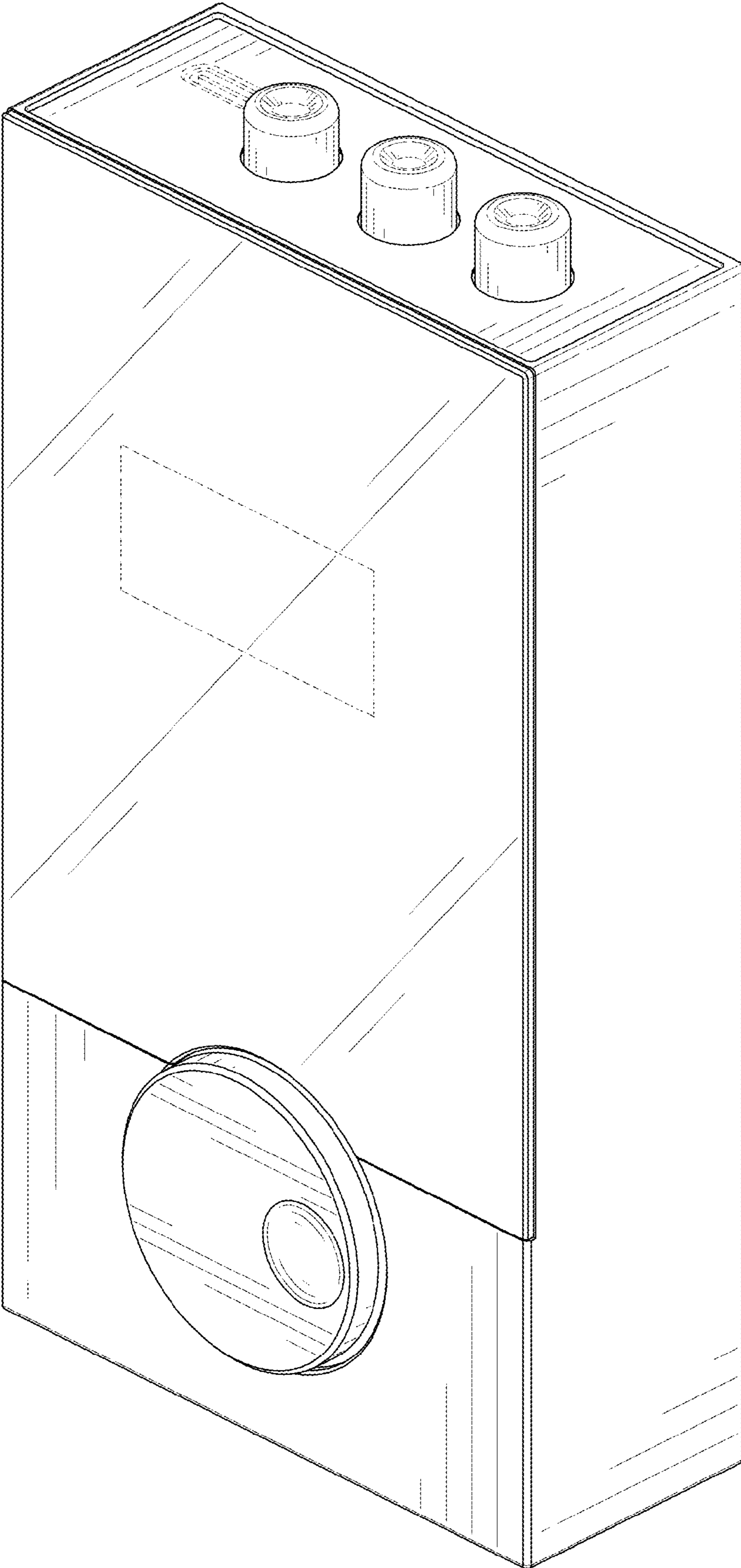

FIG. 1

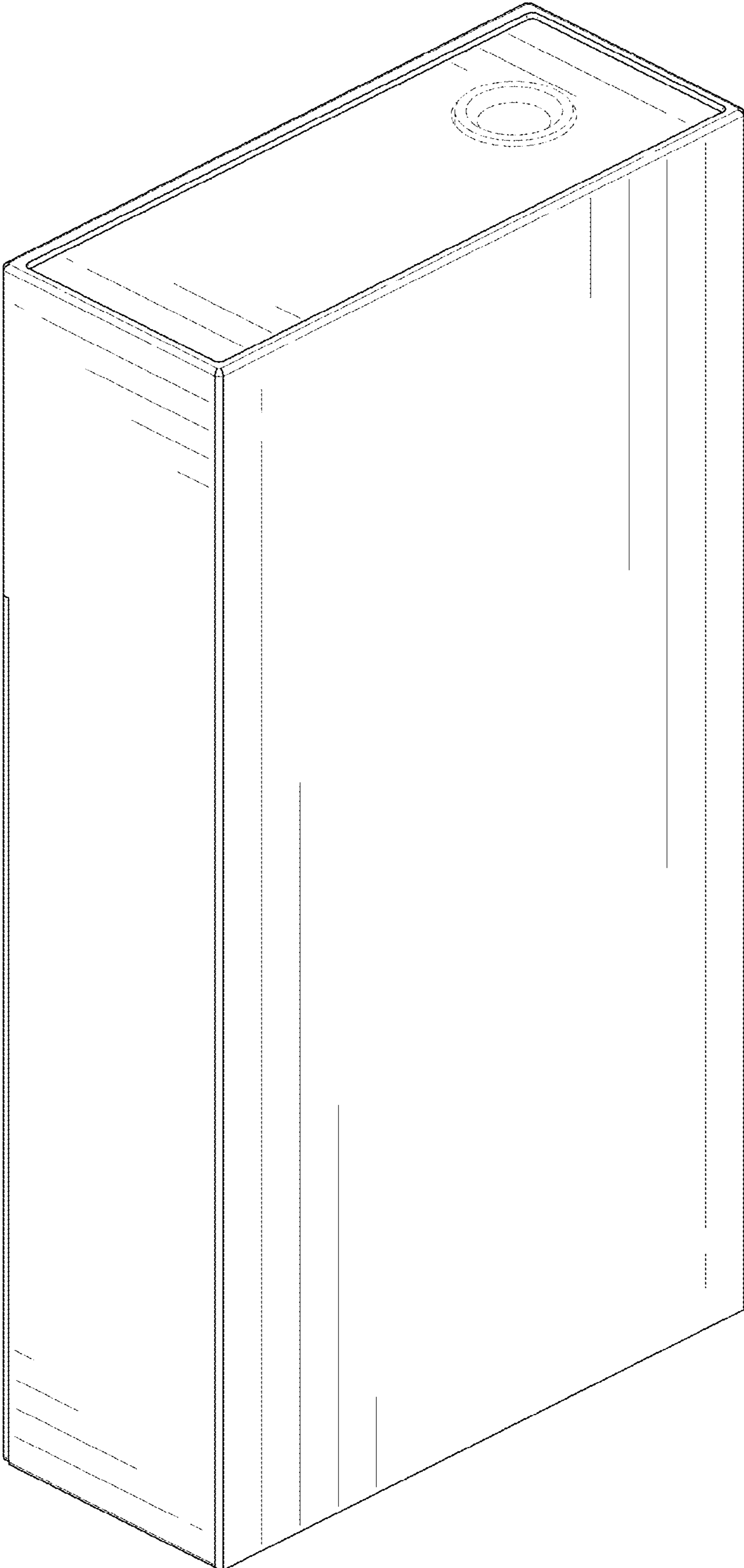

FIG. 2

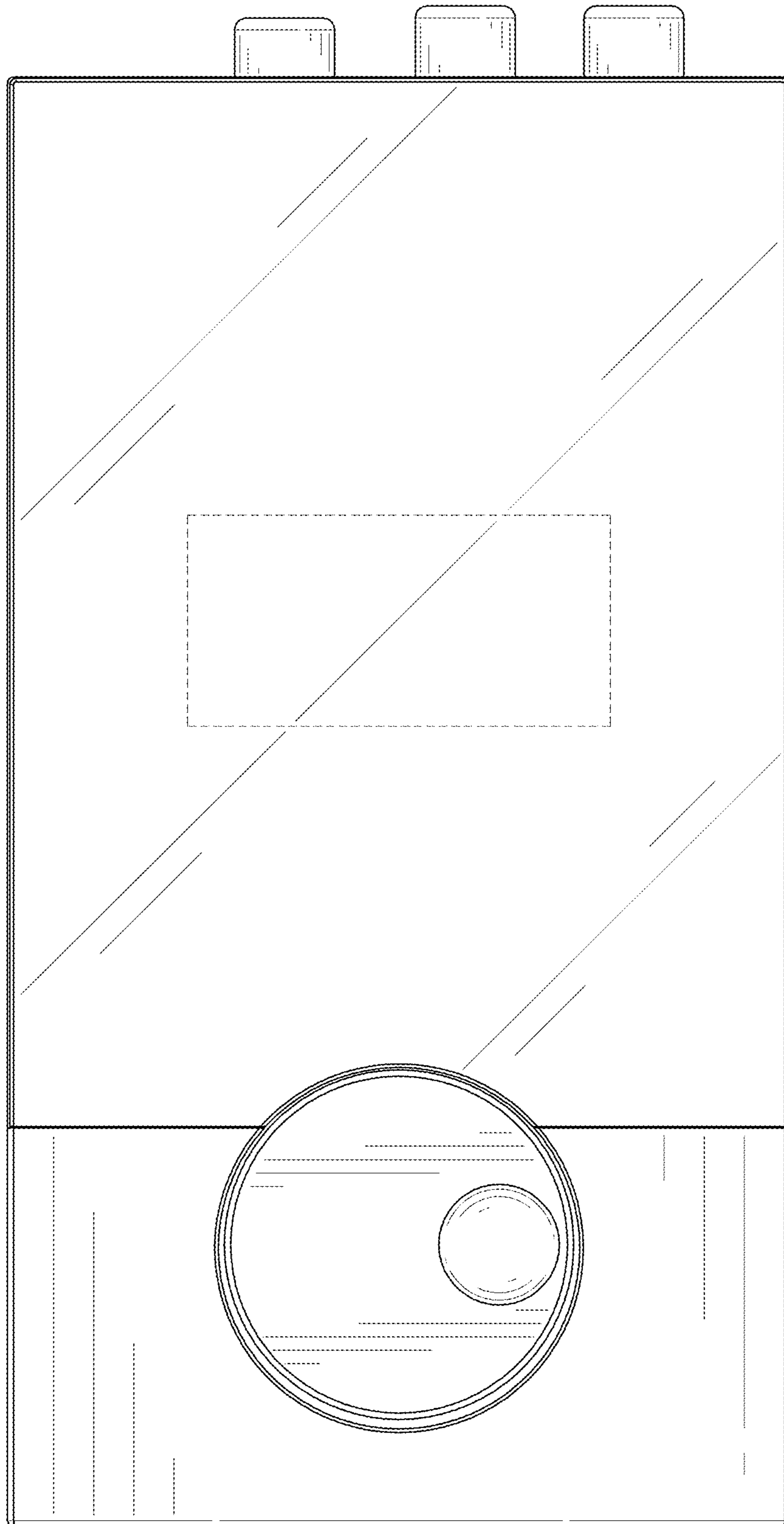

FIG. 3

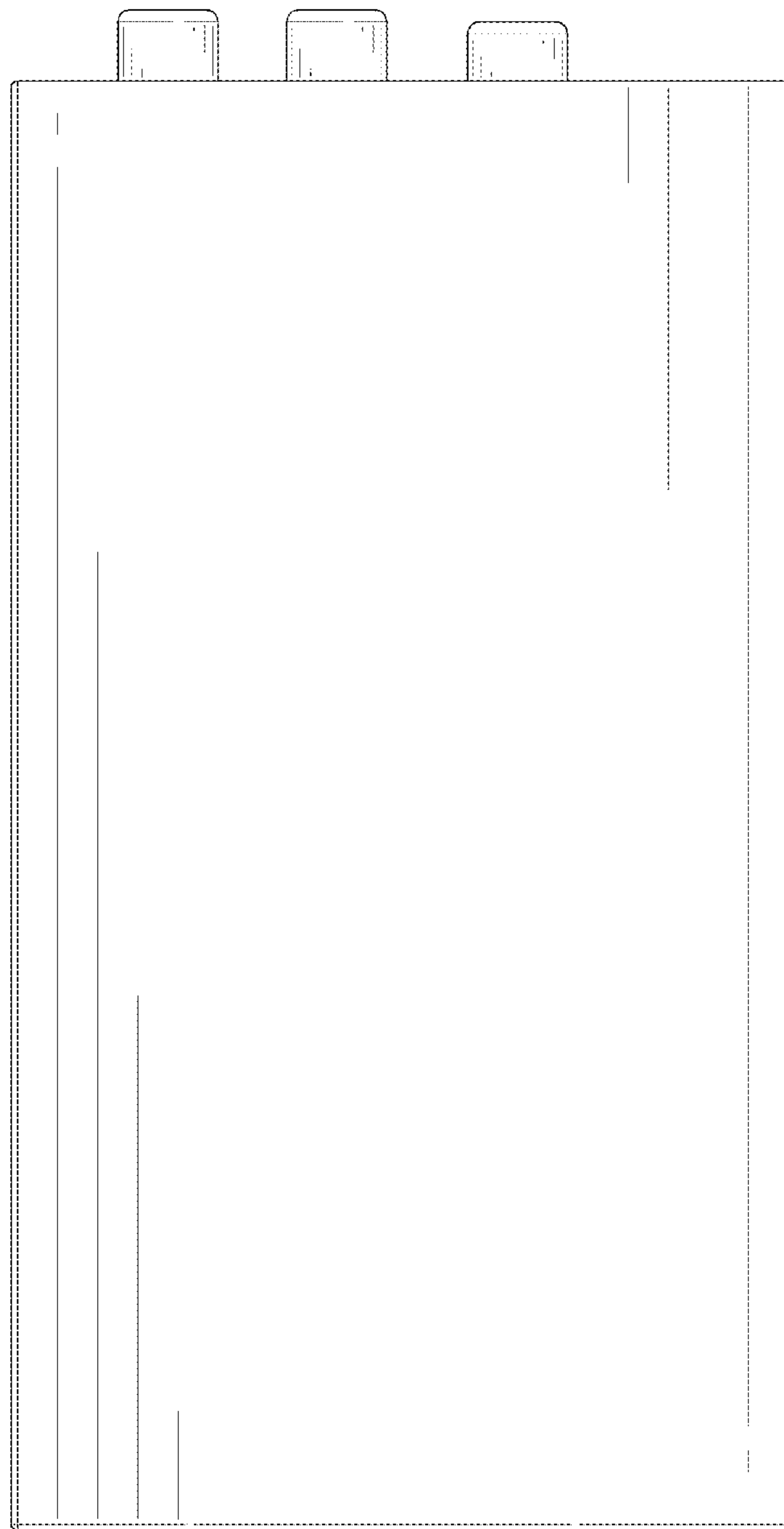

FIG. 4

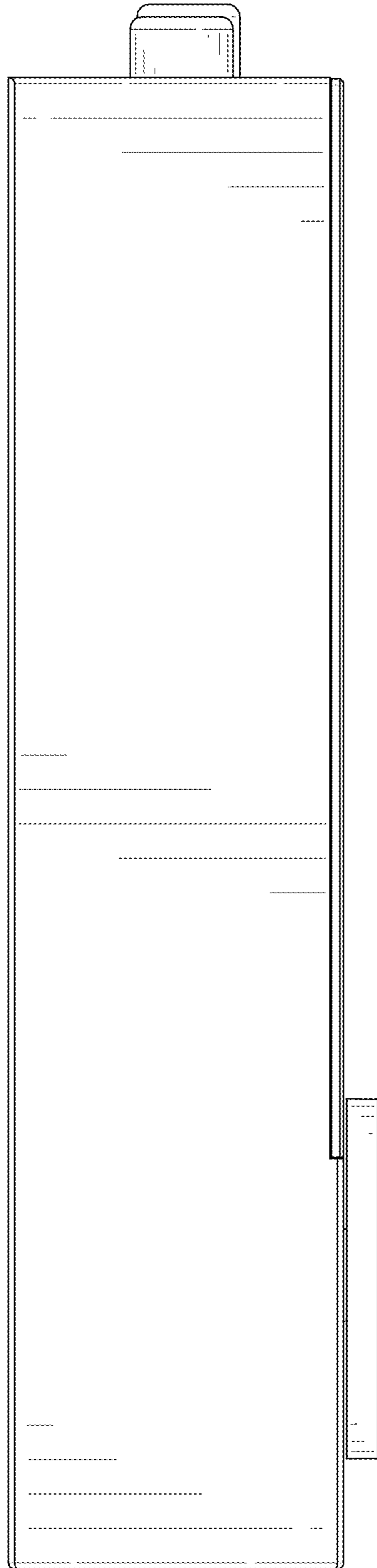

FIG. 5

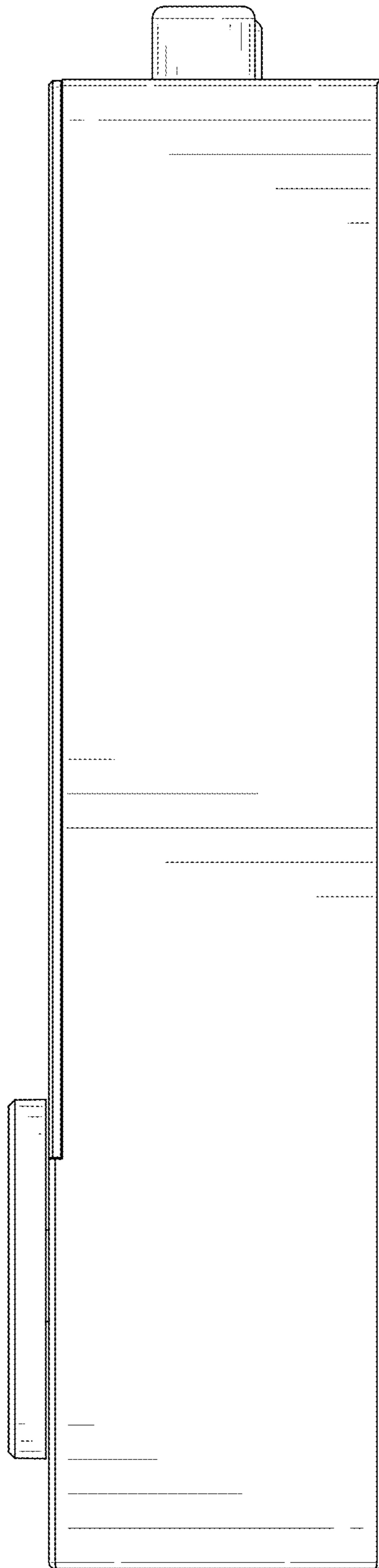

FIG. 6

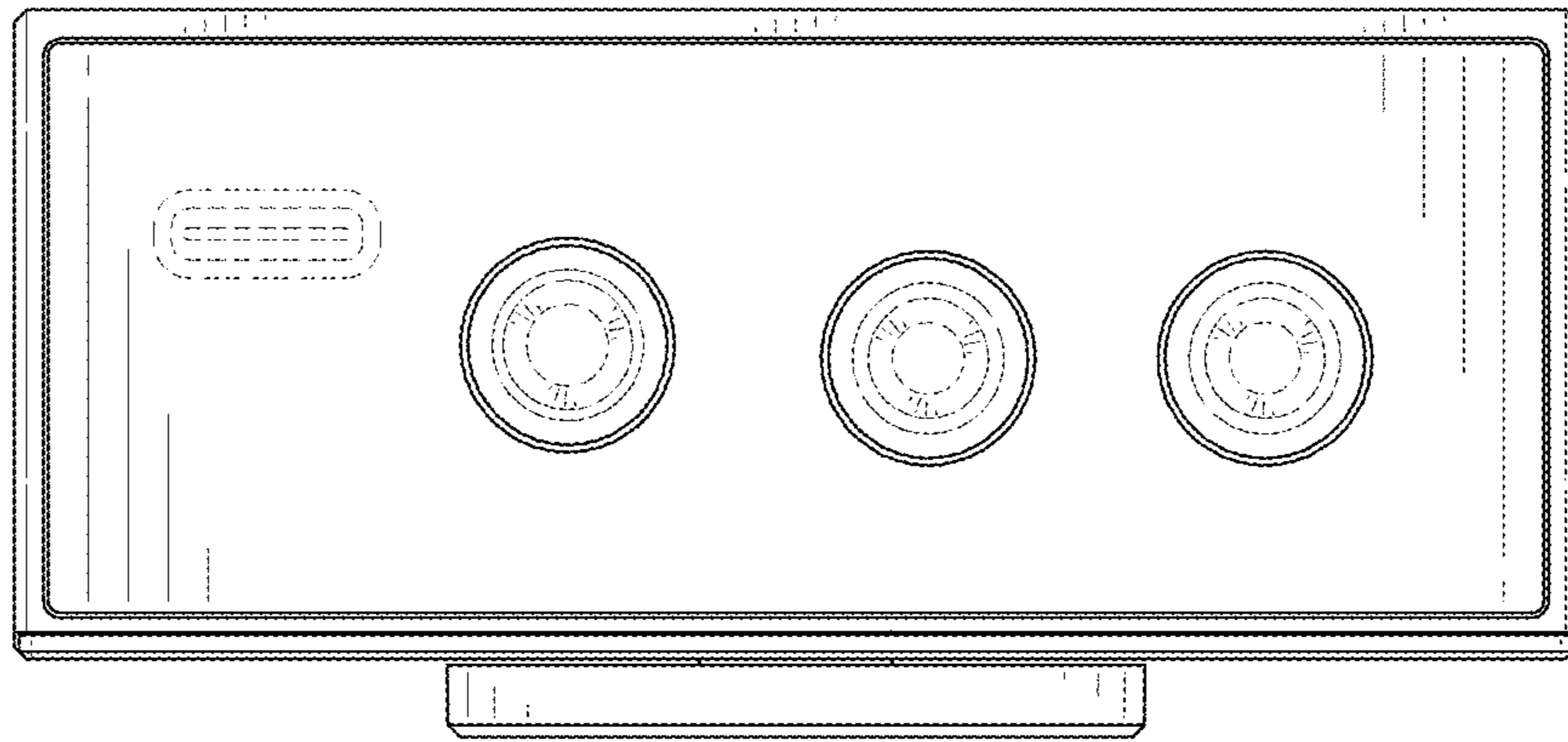

FIG. 7

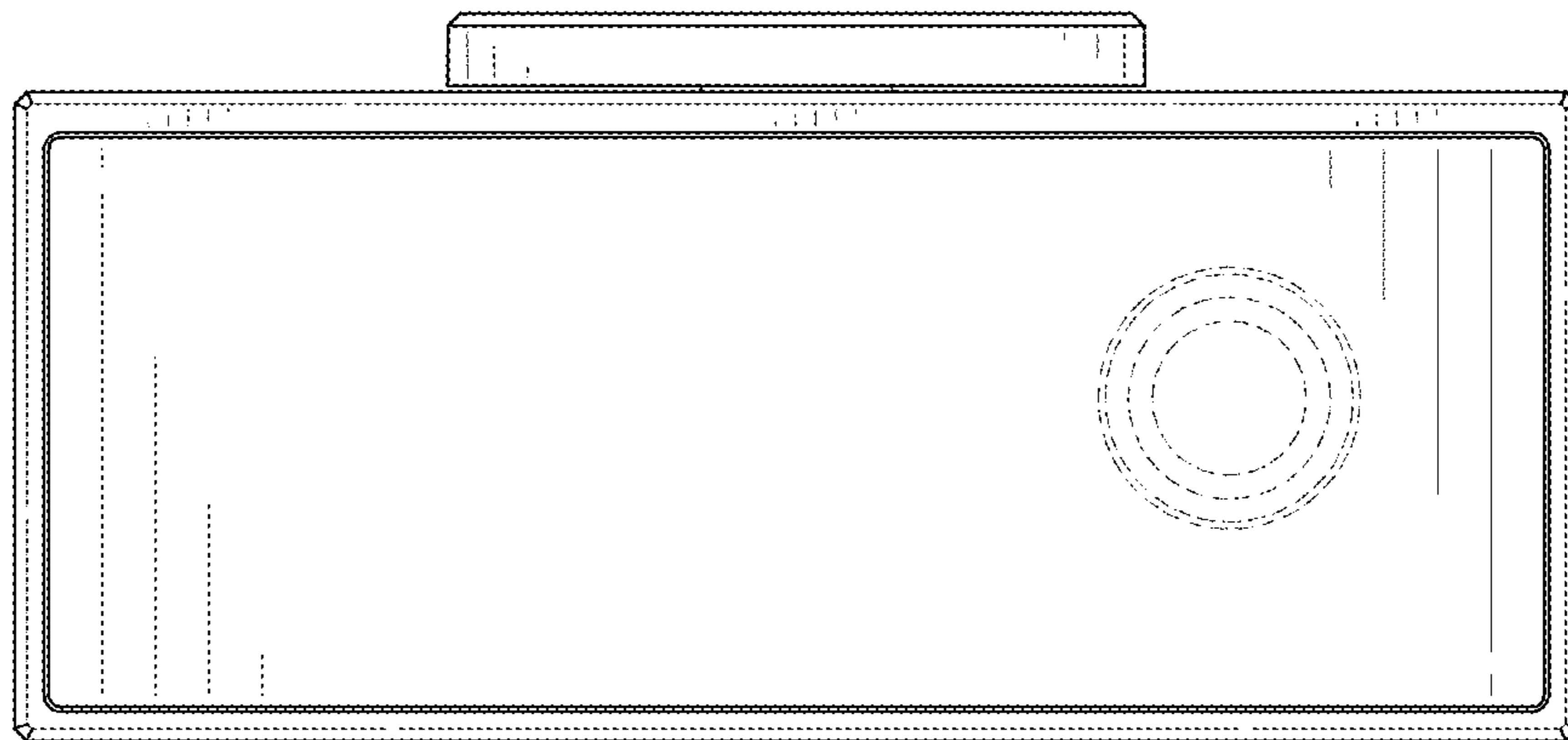

FIG. 8