

US00D975668S

(12) **United States Design Patent**  
**Park et al.**

(10) **Patent No.:** **US D975,668 S**  
(45) **Date of Patent:** **\*\* Jan. 17, 2023**

(54) **MOBILE PHONE**

- (71) Applicant: **LG ELECTRONICS INC.**, Seoul (KR)
- (72) Inventors: **Doyoung Park**, Seoul (KR); **Hongkyu Park**, Seoul (KR); **Sojin Kim**, Seoul (KR)
- (73) Assignee: **LG ELECTRONICS INC.**, Seoul (KR)
- (\*\*) Term: **15 Years**

- (21) Appl. No.: **29/749,041**
- (22) Filed: **Sep. 2, 2020**

(30) **Foreign Application Priority Data**

Mar. 5, 2020 (KR) ..... 30-2020-0010018

(51) **LOC (14) Cl.** ..... **14-03**

(52) **U.S. Cl.**  
USPC ..... **D14/138 AB**

(58) **Field of Classification Search**  
USPC ..... D14/138 AA, 138 AB, 138 AC, 138 AD, D14/138 C, 138 R, 138 G, 214, 248, 250, D14/330, 341, 345-347, 426  
CPC ... G06F 1/1652; H04M 1/027; H04M 1/0202; H04M 1/0279; H04M 1/0235; H04M 1/0237; H04M 1/0239; H04M 1/0266; H04M 1/0268; H04M 1/0295  
See application file for complete search history.

(56) **References Cited**

**U.S. PATENT DOCUMENTS**

- D716,253 S \* 10/2014 Lee ..... D14/138 AB
- D746,285 S \* 12/2015 Okabe ..... D14/345
- D754,657 S \* 4/2016 Kim ..... D14/345
- D766,891 S \* 9/2016 Hong ..... D14/341
- D768,128 S \* 10/2016 Cho ..... D14/341

(Continued)

**OTHER PUBLICATIONS**

Why go foldable—New Huawei patent reveals phones with sliding display, first available Apr. 16, 2020 [online], retrieved Aug. 9, 2022, available at URL: <https://www.androidauthority.com/huawei-sliding-display-1107115/> (Year: 2020).\*

(Continued)

*Primary Examiner* — Wendy L Arminio

*Assistant Examiner* — Carrie S Gelula

(74) *Attorney, Agent, or Firm* — Birch, Stewart, Kolasch & Birch, LLP

(57) **CLAIM**

The ornamental design for a mobile phone, as shown and described.

**DESCRIPTION**

FIG. 1 is a front perspective view of the mobile phone showing our new design;  
FIG. 2 is a front view thereof;  
FIG. 3 is a back view thereof;  
FIG. 4 is a left side view thereof;  
FIG. 5 is a right side view thereof;  
FIG. 6 is a top plan view thereof;  
FIG. 7 is a bottom plan view thereof;  
FIG. 8 is a back perspective view thereof;  
FIG. 9 is a front perspective view in a condition that the claimed design has not been folded;  
FIG. 10 is a front view of FIG. 9;  
FIG. 11 is a back view of FIG. 9;  
FIG. 12 is a left side view of FIG. 9;  
FIG. 13 is a right side view of FIG. 9;  
FIG. 14 is a top plan view of FIG. 9;  
FIG. 15 is a bottom plan view of FIG. 9; and,  
FIG. 16 is a back perspective view of FIG. 9.  
The broken lines depict portions of the mobile phone that form no part of the claimed design.

**1 Claim, 16 Drawing Sheets**

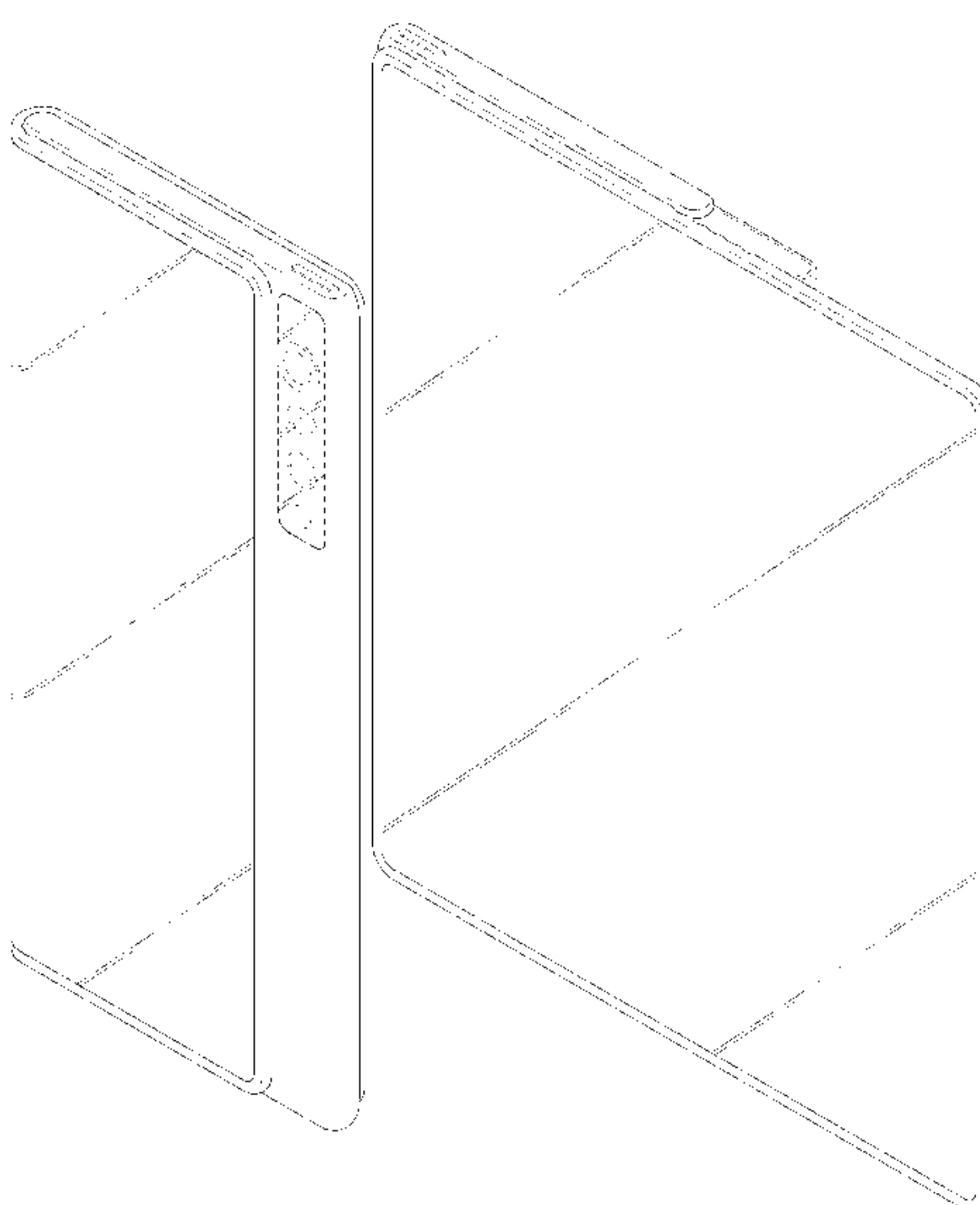

(56)

**References Cited**

U.S. PATENT DOCUMENTS

D801,294	S	*	10/2017	Kim	.....	D14/138	G
D820,801	S	*	6/2018	Yeom	.....	D14/138	AB
D830,325	S	*	10/2018	Han	.....	G06F 1/1616	
						D14/138	AB
D890,714	S	*	7/2020	Ma	.....	D14/138	AB
D894,145	S	*	8/2020	Lee	.....	D14/138	AB
D897,301	S	*	9/2020	Lee	.....	D14/138	AB
D915,334	S	*	4/2021	Lee	.....	D14/138	AD
D915,335	S	*	4/2021	Lee	.....	D14/138	AD
D915,336	S	*	4/2021	Lee	.....	D14/138	AD
D917,412	S	*	4/2021	Seo	.....	D14/138	AB
D923,598	S	*	6/2021	Lee	.....	H04M 1/0268	
						D14/138	AD
D923,620	S	*	6/2021	Kim	.....	D14/342	
D928,108	S	*	8/2021	Huang	.....	D14/138	AB
D956,040	S	*	6/2022	Min	.....	D14/341	
D956,740	S	*	7/2022	Min	.....	D14/341	
2021/0058502	A1	*	2/2021	Liao	.....	H04M 1/0268	

OTHER PUBLICATIONS

HP foldable smartphone with clamshell design—LetsGoDigital, first available Sep. 17, 2020 [online], retrieved Aug. 9, 2022, available at URL: <https://en.letsgodigital.org/smartphones/hp-foldable-smartphone/> (Year: 2020).\*

\* cited by examiner

FIG. 1

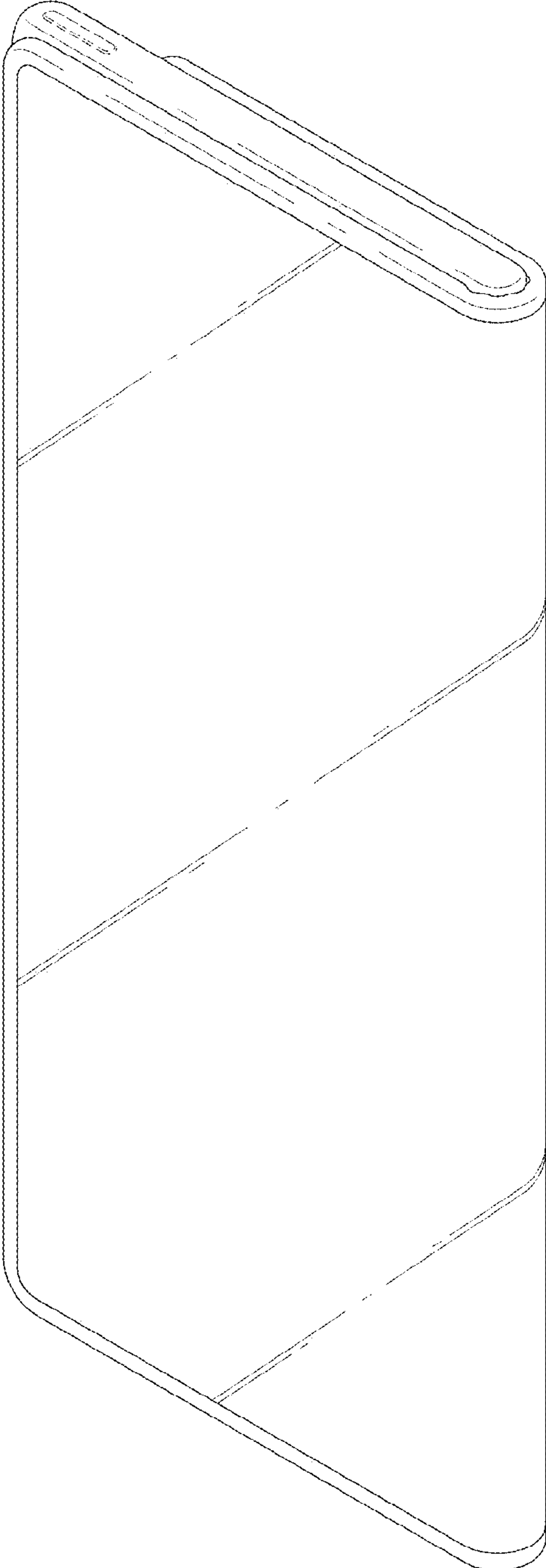

FIG. 2

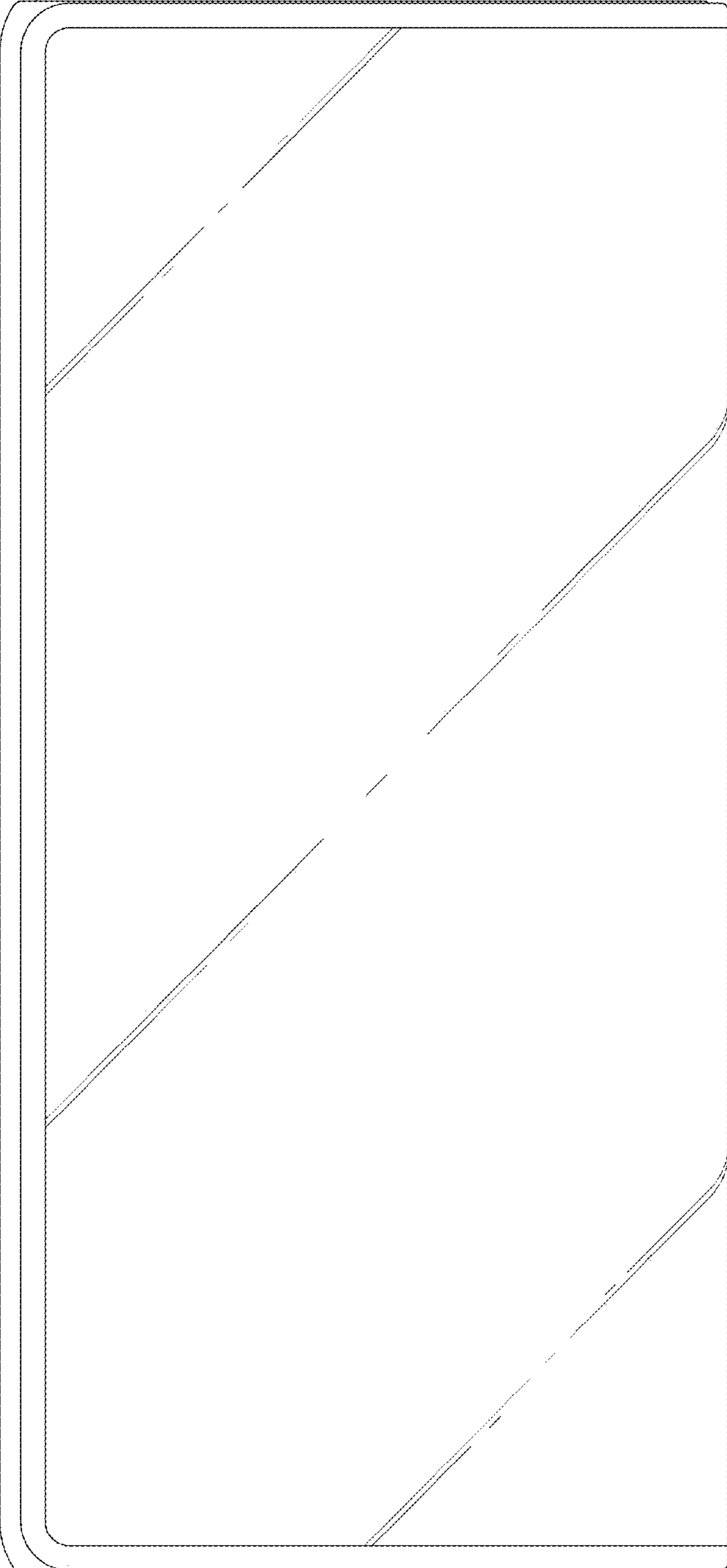

FIG. 3

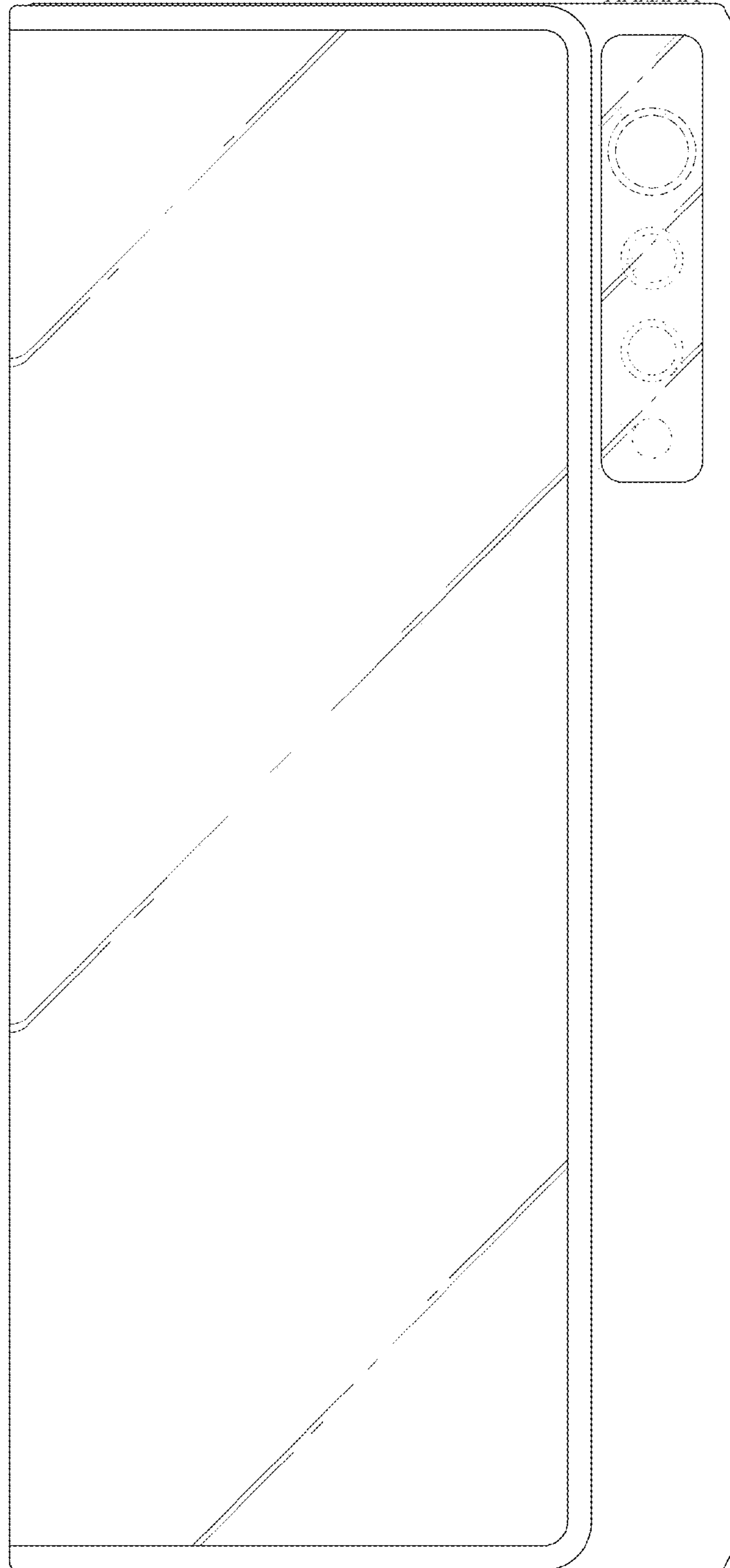

FIG. 4

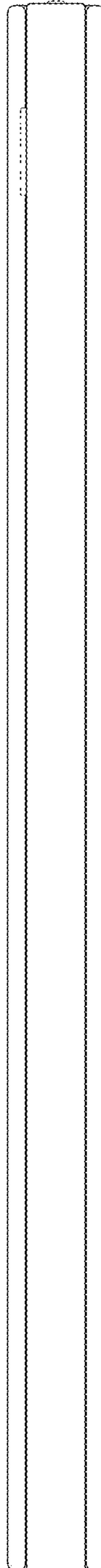

FIG. 5



FIG. 6

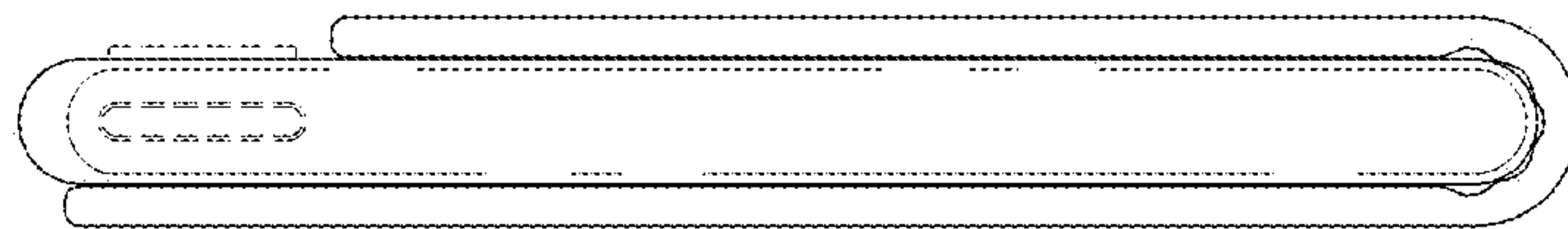



FIG. 7

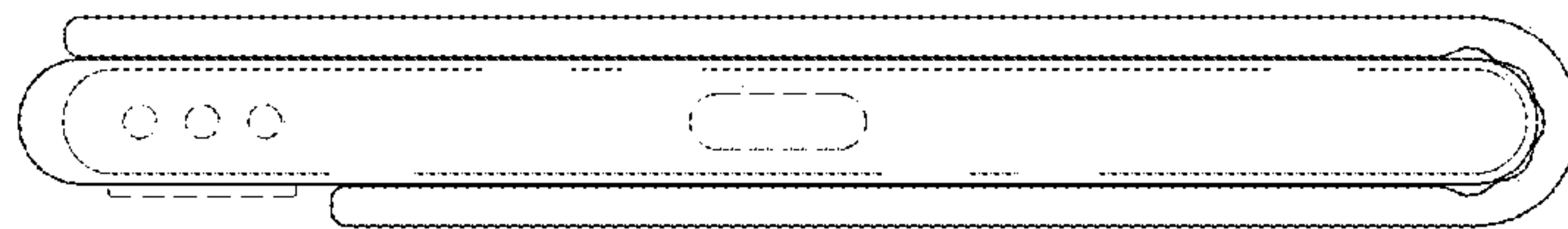

FIG. 8

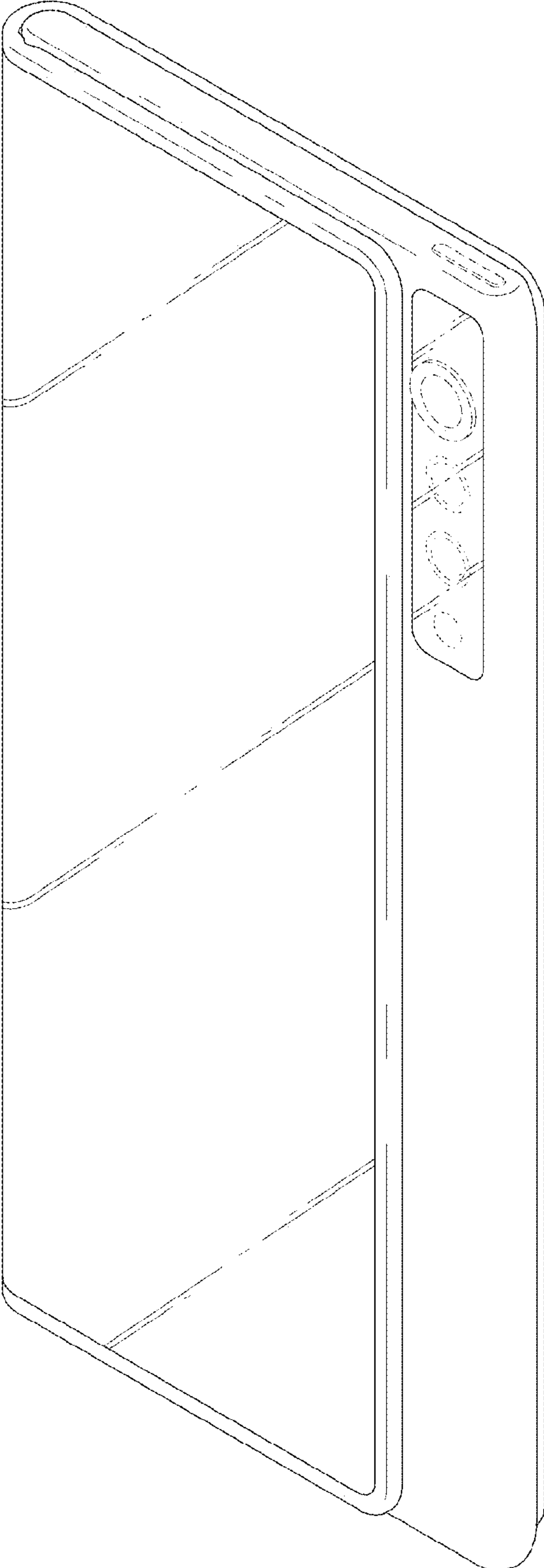

FIG. 9

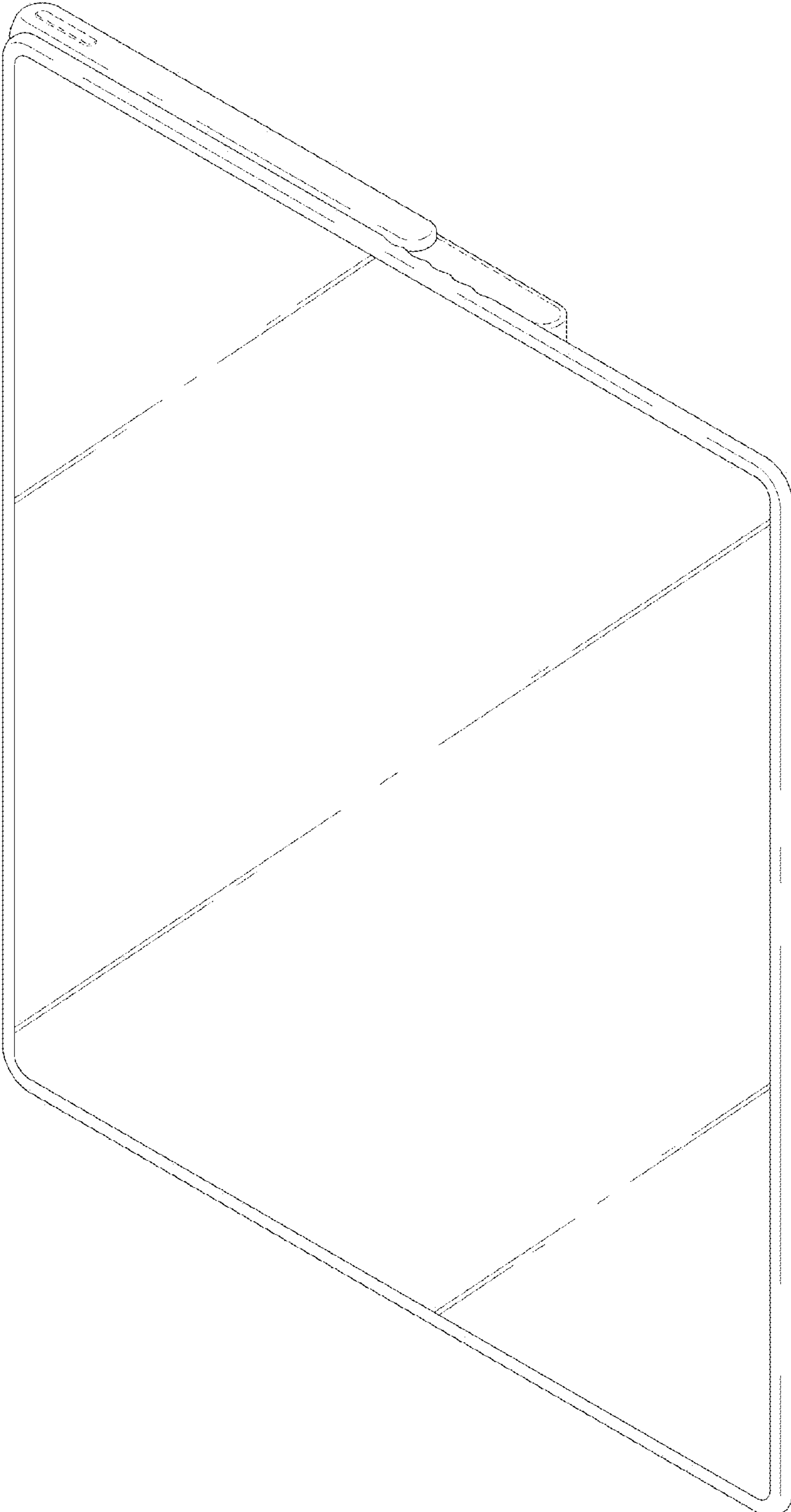

FIG. 10

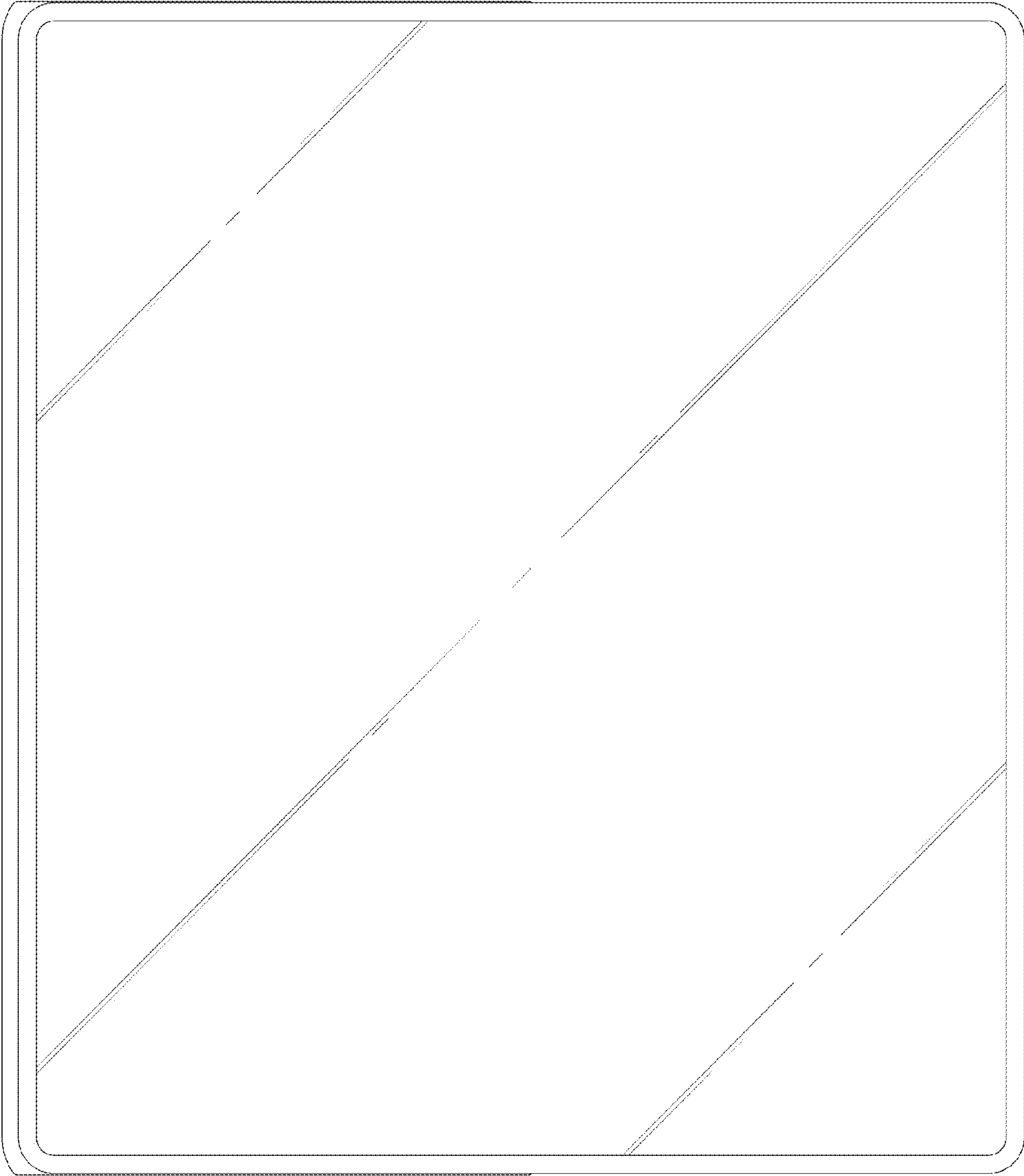

FIG. 11

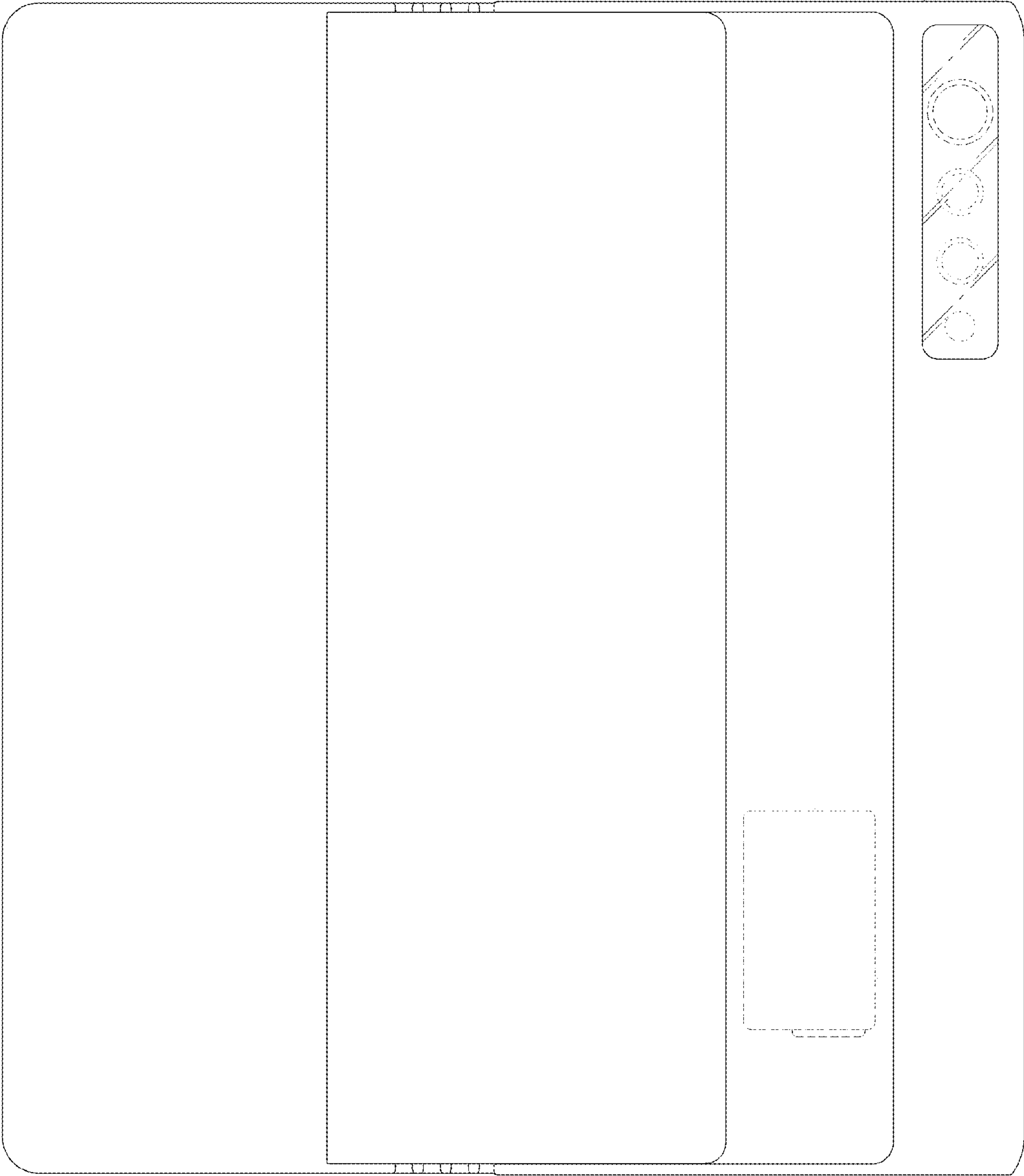

FIG. 12



FIG. 13

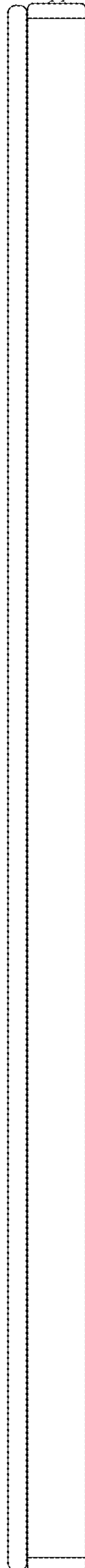

FIG. 14

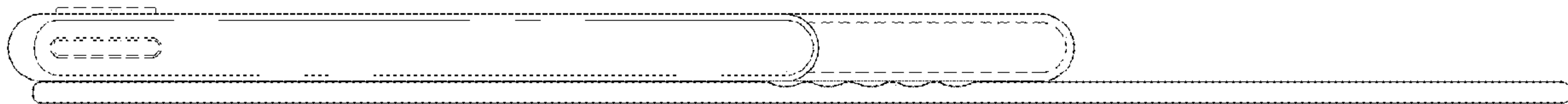



FIG. 15

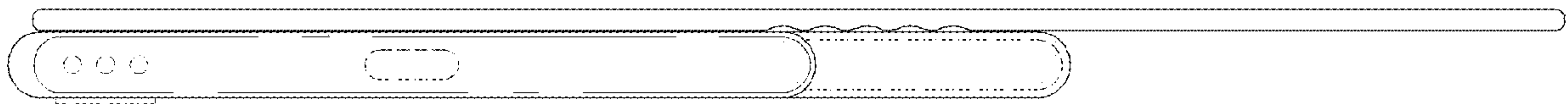

FIG. 16

