



US00D975490S

(12) **United States Design Patent** (10) **Patent No.:** **US D975,490 S**
Shen (45) **Date of Patent:** **** Jan. 17, 2023**

(54) **BARBECUE GRILL**
(71) Applicant: **Nelson Shen**, Dongguan (CN)
(72) Inventor: **Nelson Shen**, Dongguan (CN)
(**) Term: **15 Years**
(21) Appl. No.: **29/752,701**
(22) Filed: **Sep. 29, 2020**
(51) **LOC (14) Cl.** **07-02**
(52) **U.S. Cl.**
USPC **D7/334**
(58) **Field of Classification Search**
USPC D7/323, 332-339, 387, 402-406, 408,
D7/409; D21/523, 524; D23/335, 337,
D23/339, 343, 345
CPC A47J 37/00; A47J 37/06; A47J 37/0647;
A47J 37/0658; A47J 37/07-0754; A47J
37/0763; A47J 37/0781; A47J 37/0786;
A47J 2037/0777; A47J 2037/0795
See application file for complete search history.

(56) **References Cited**
U.S. PATENT DOCUMENTS
D266,050 S * 9/1982 Best D7/334
D560,417 S * 1/2008 Ho D7/334
D805,343 S * 12/2017 Magee D7/334
D886,509 S * 6/2020 Caroen A47J 37/0704
D7/338
2015/0027432 A1* 1/2015 Contarino, Jr. A47J 37/0704
126/25 R

2020/0375395 A1* 12/2020 Pai A47J 37/074
2022/0071444 A1* 3/2022 Springer A47J 37/0786
2022/0071446 A1* 3/2022 Liu A47J 37/0704
2022/0142404 A1* 5/2022 Conrad F24C 15/327

OTHER PUBLICATIONS

Nuke Delta Outdoor Charcoal Grill in Black with Cover, Home Depot, [online], [site visited May 27, 2022], Available from internet URL: <https://www.homedepot.com/p/Delta-Outdoor-Charcoal-Grill-in-Black-with-Cover-DELTA/317041851> (Year: 2022).*

* cited by examiner

Primary Examiner — Mary Ann Calabrese
Assistant Examiner — Natalya M Rapundalo
(74) *Attorney, Agent, or Firm* — Bruce Stone LLP;
Joseph A. Bruce

(57) **CLAIM**
The ornamental design for a barbecue grill, as shown and described.

DESCRIPTION

FIG. 1 is a front, left side perspective view of my new ornamental design for a barbecue grill;
FIG. 2 is a front elevation view thereof;
FIG. 3 is a rear elevation view thereof;
FIG. 4 is a left, side elevation view thereof;
FIG. 5 is a right, side elevation view thereof;
FIG. 6 is a top plan view thereof; and,
FIG. 7 is a bottom plan view thereof.
The broken lines in the drawings show portions of the barbecue grill and form no part of the claimed design.

1 Claim, 7 Drawing Sheets

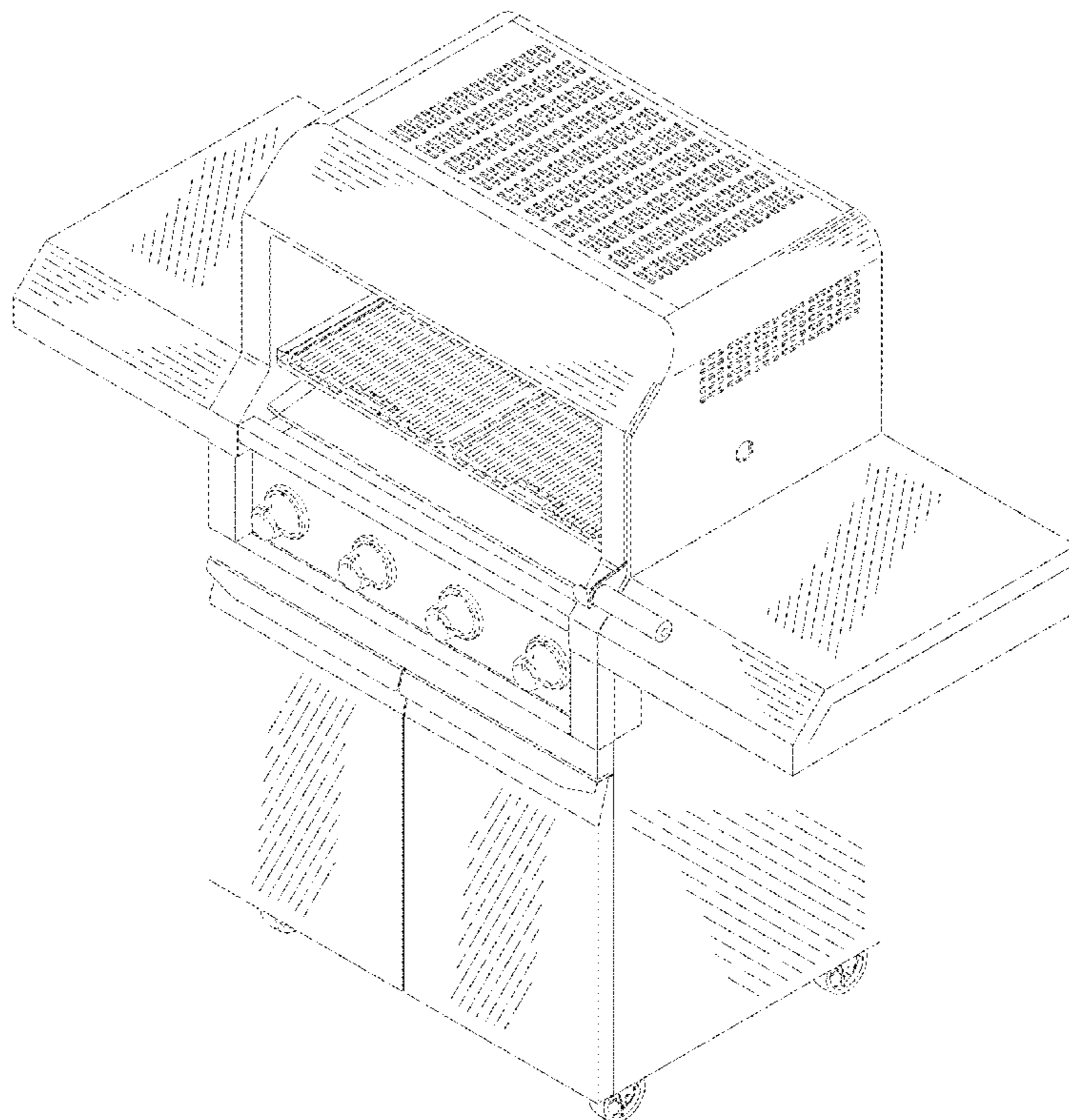

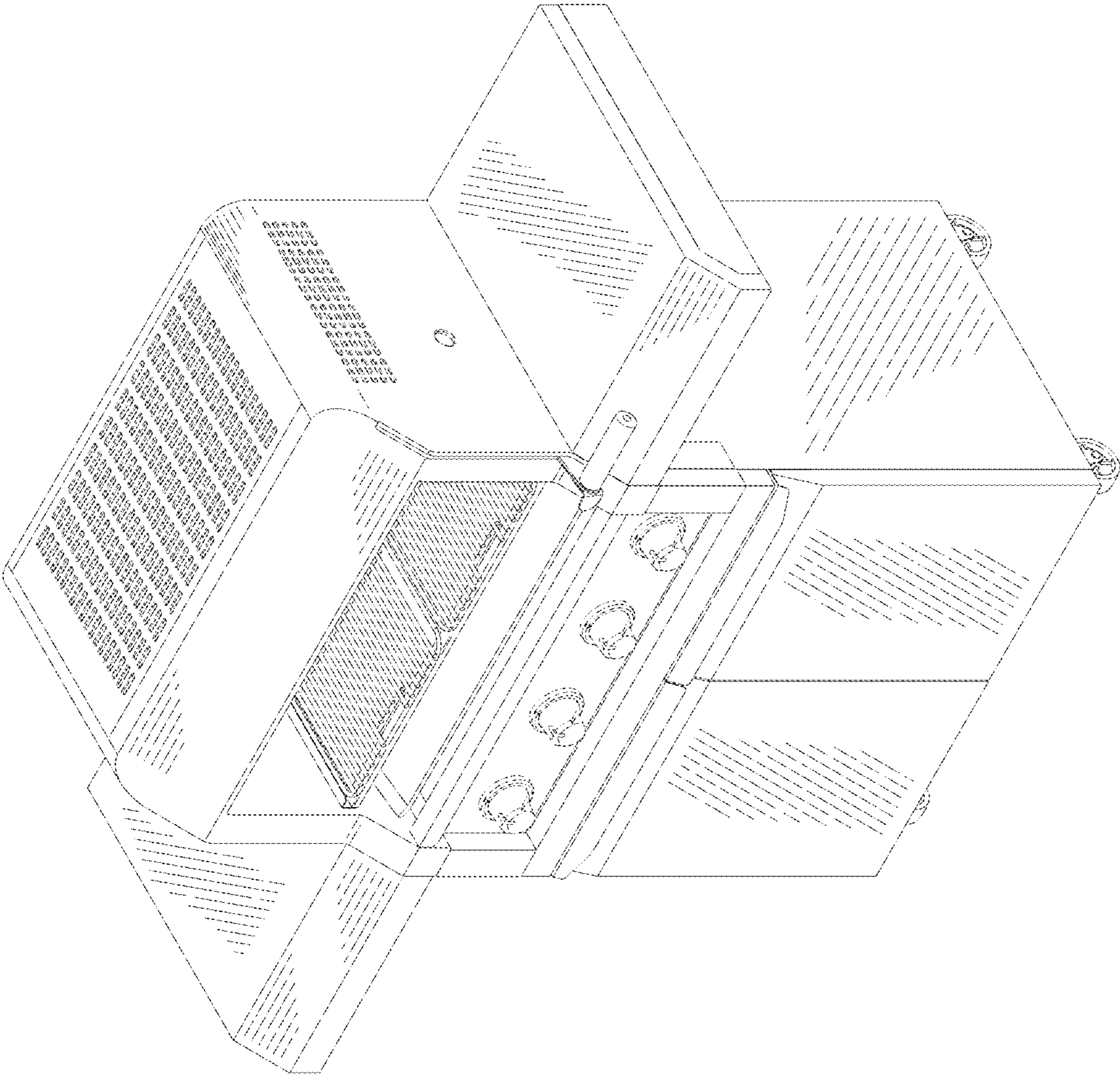

FIG. 1

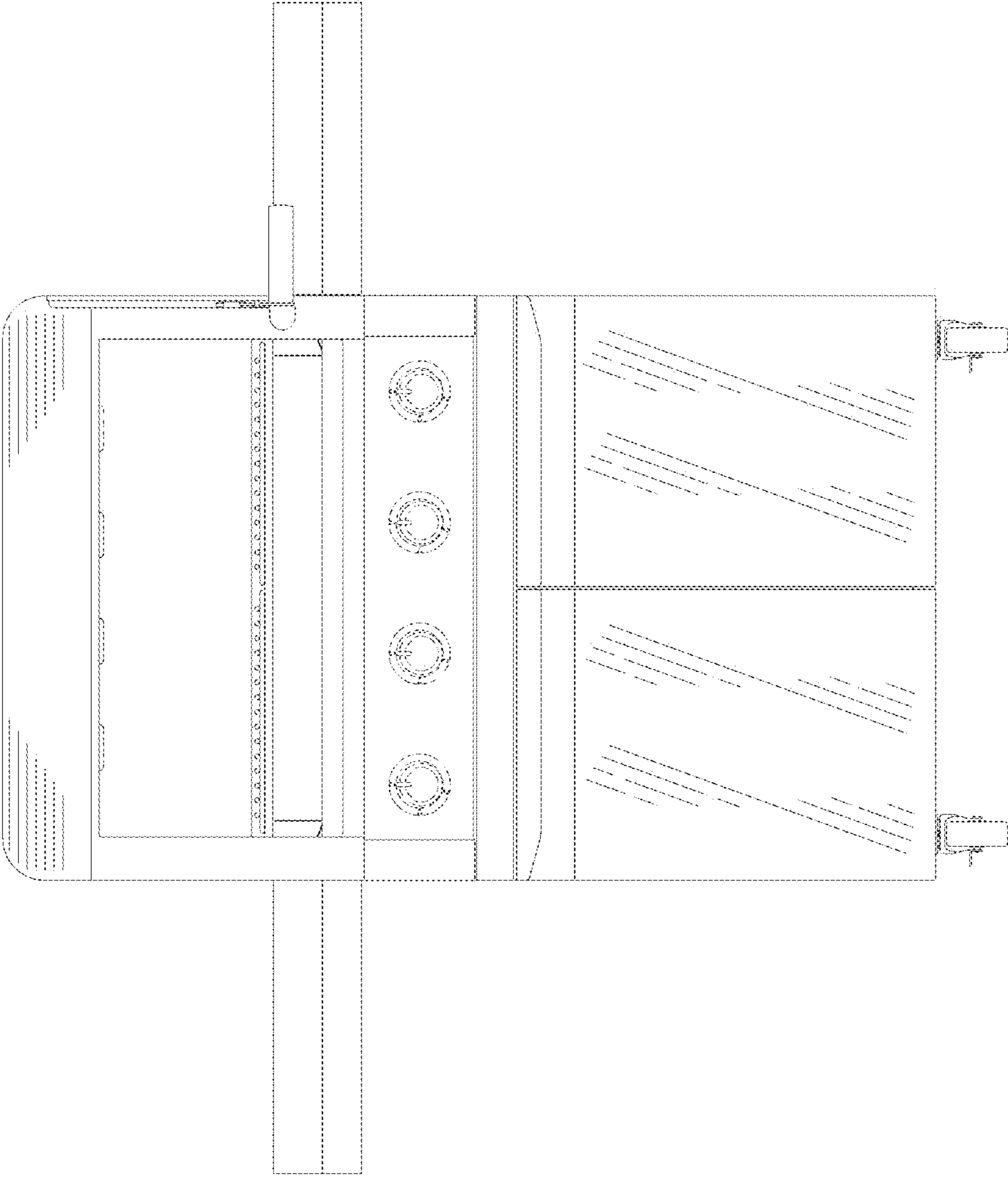

FIG. 2

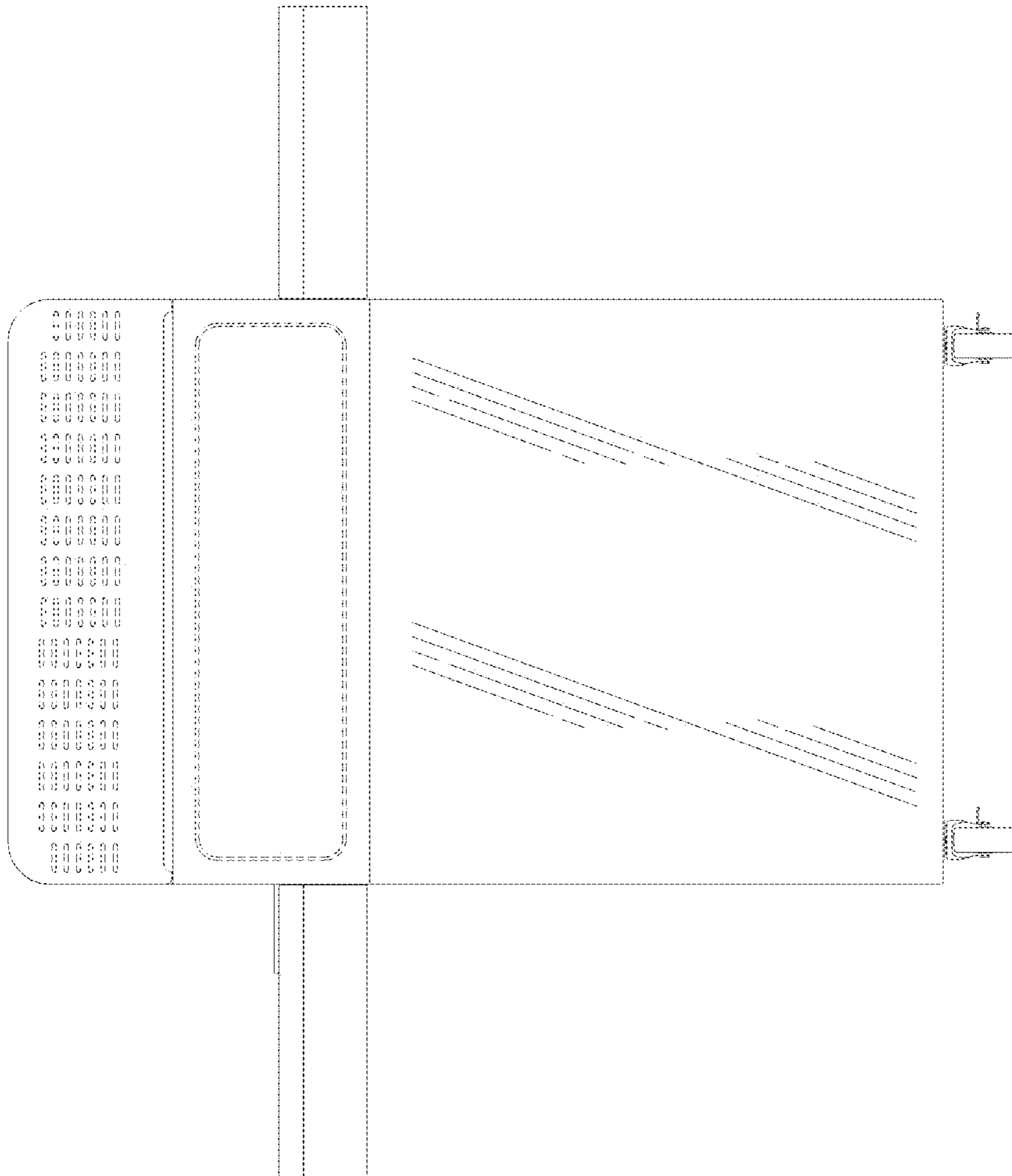

FIG. 3

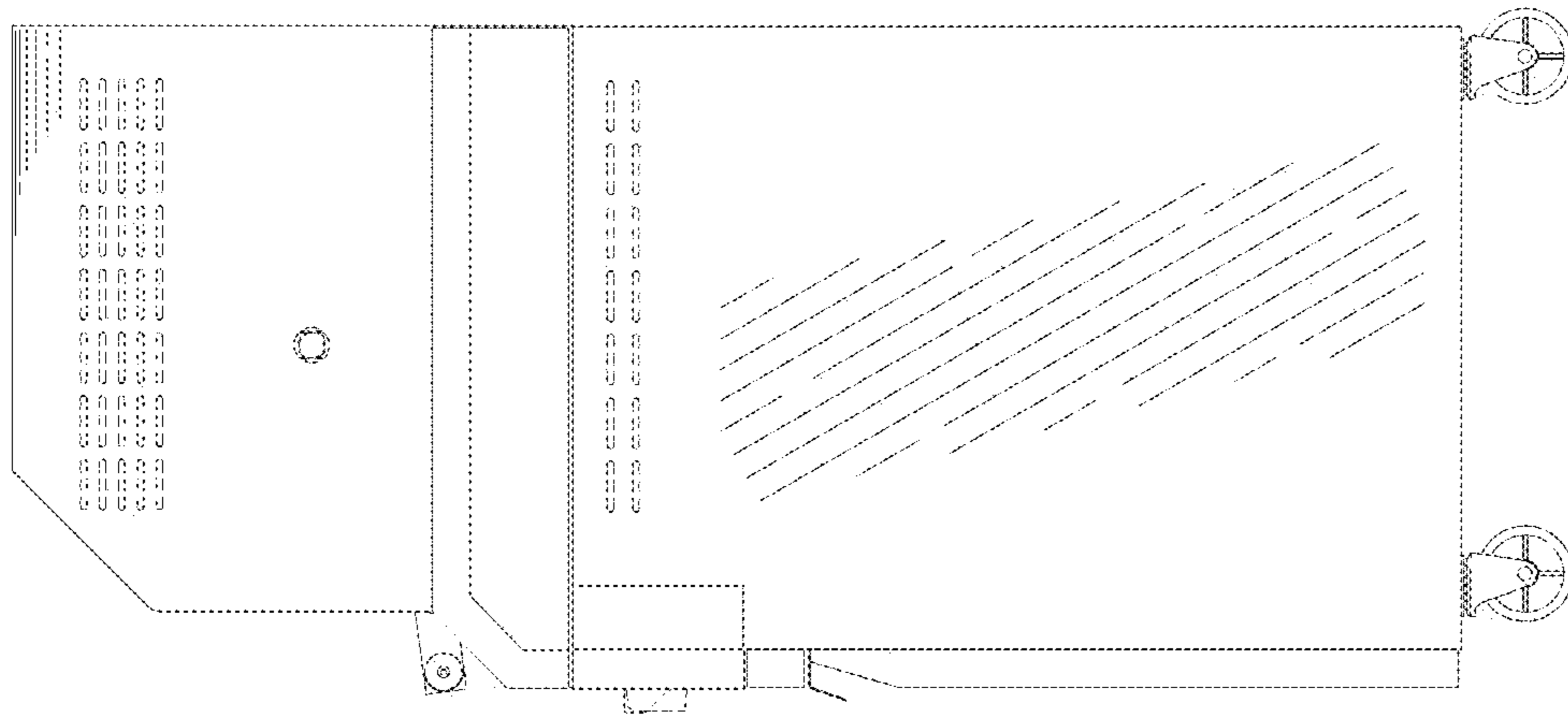

FIG. 4

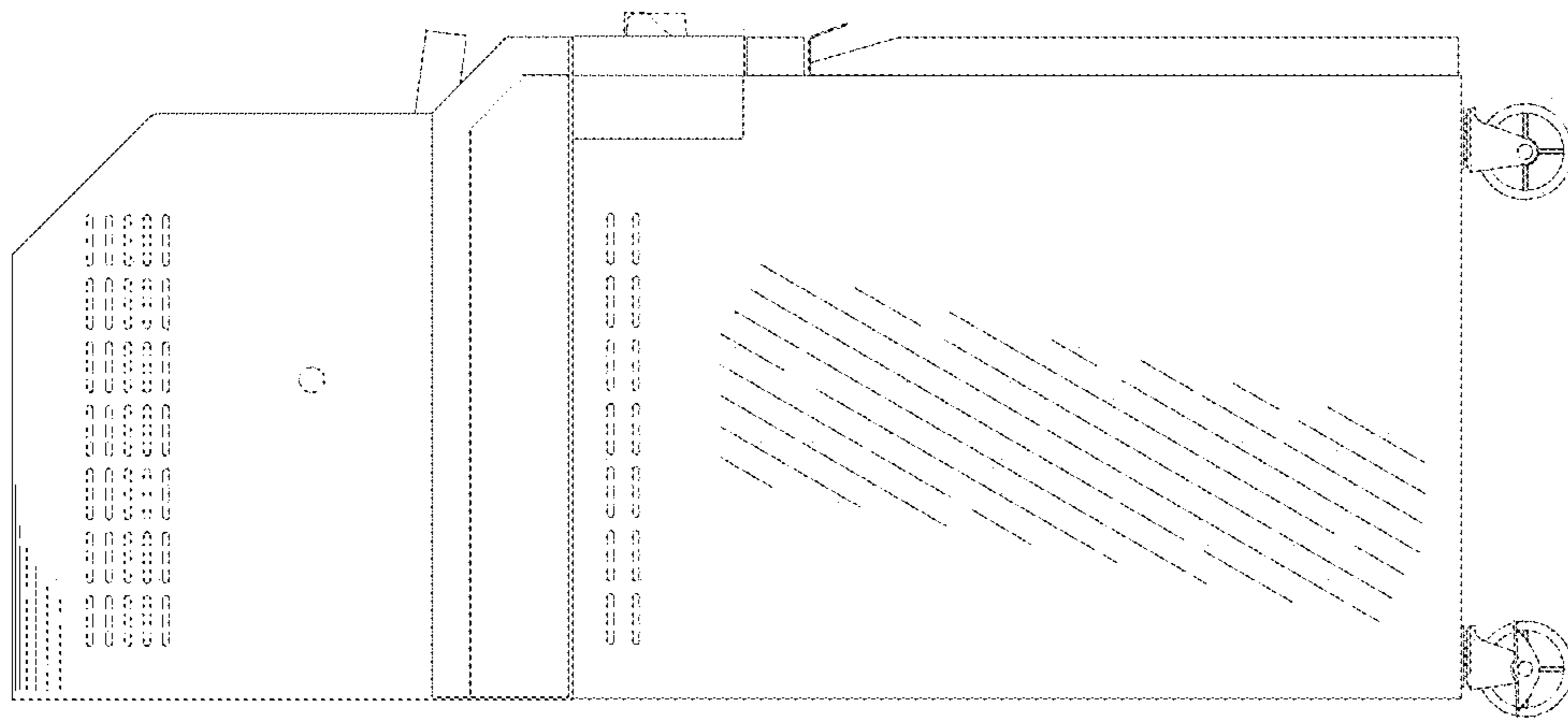

FIG. 5

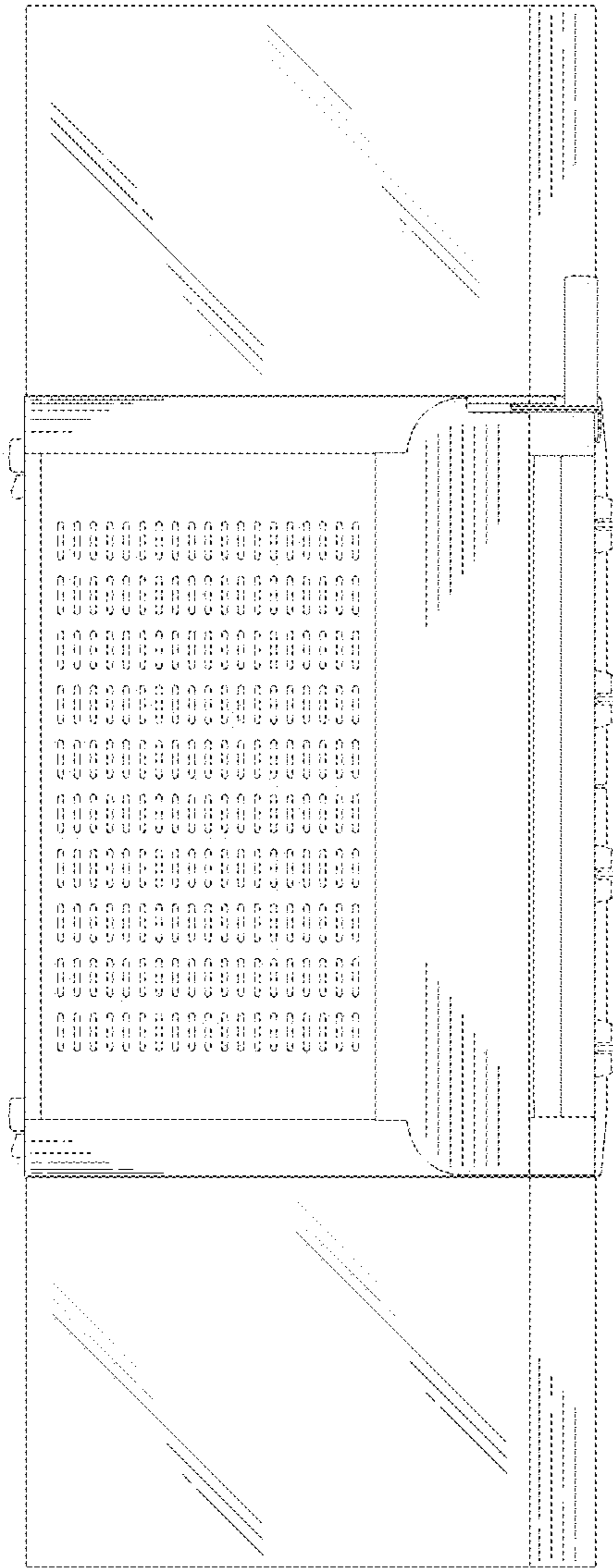

FIG. 6

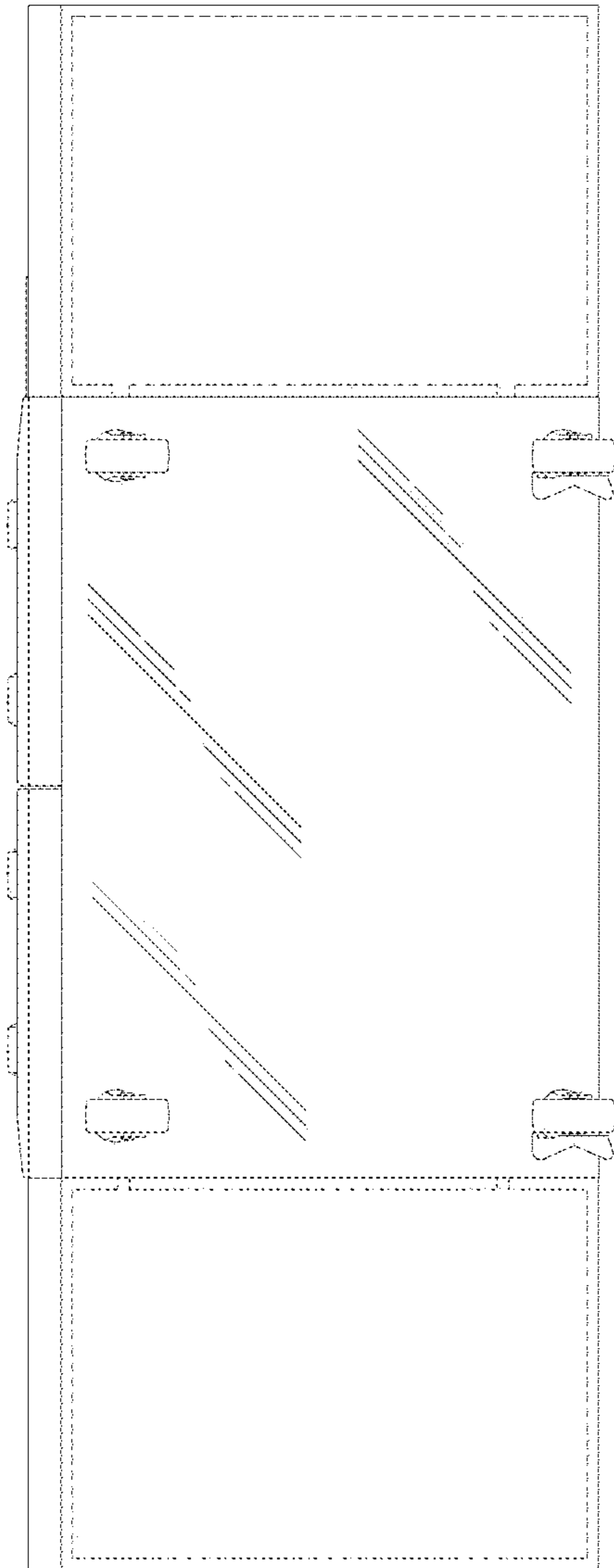

FIG. 7