



US00D975445S

(12) **United States Design Patent**
Baumgart

(10) **Patent No.:** **US D975,445 S**
(45) **Date of Patent:** **** Jan. 17, 2023**

(54) **TOOLBOX**

(71) Applicant: **Mark Baumgart**, Humphrey, NE (US)

(72) Inventor: **Mark Baumgart**, Humphrey, NE (US)

(**) Term: **15 Years**

(21) Appl. No.: **29/703,299**

(22) Filed: **Aug. 26, 2019**

(51) **LOC (14) Cl.** **03-01**

(52) **U.S. Cl.**

USPC **D3/294**

(58) **Field of Classification Search**

USPC D3/294–299, 905; D6/663, 664, 667,
D6/670; D7/601, 602, 609, 619.1,
D7/631–633, 635, 637, 638; D9/414,
D9/420–423, 434, 435, 499, 700, 701
CPC B25H 3/00; B25H 3/003; B25H 3/006;
B25H 3/02; B25H 3/021; B25H 3/022;
B25H 3/023; B25H 3/025; B25H 3/026;
B25H 3/027; B25H 3/028; B25H 3/04;
B25H 3/06; B25H 5/00

See application file for complete search history.

(56) **References Cited**

U.S. PATENT DOCUMENTS

D8,860 S * 12/1875 Tim D3/296
1,369,439 A * 2/1921 Johnson A45C 11/34
312/231
D116,229 S * 8/1939 Garten D7/609
D178,604 S * 8/1956 Heil D3/274
D242,451 S * 11/1976 Zamora D19/60
4,266,835 A * 5/1981 Schmidt B25H 3/02
D3/905
D275,012 S * 8/1984 Sonnek D3/905
D278,894 S * 5/1985 James D12/408
D283,271 S * 4/1986 Bannigan D13/139.7
D324,085 S * 2/1992 Morton D3/276
D325,930 S * 5/1992 Breen D19/76
D332,524 S * 1/1993 Gray D3/905

D356,904 S * 4/1995 Wolff D24/185
D362,924 S * 10/1995 Mers D28/61
D365,208 S * 12/1995 Laib D3/294
D371,918 S * 7/1996 Brunner D6/670
D378,671 S * 4/1997 Herrs D12/423

(Continued)

FOREIGN PATENT DOCUMENTS

CN 305540277 * 1/2020
CN 305719680 * 4/2020

(Continued)

OTHER PUBLICATIONS

Tweet, available at twitter.com, posted Sep. 28, 2019 [online], site visited Feb. 18, 2022, available from the internet URL: https://twitter.com/mark_baumgart/status/1178125714085879808?cxt=HHwWglC9jYrGxdkgAAAA (Year: 2019).*

(Continued)

Primary Examiner — Messina L Smith

Assistant Examiner — Jillian Mazzola

(74) *Attorney, Agent, or Firm* — Suiter Swantz pc llo

(57) **CLAIM**

The ornamental design for a toolbox, as shown and described.

DESCRIPTION

FIG. 1 is a perspective view of a toolbox showing our new design;

FIG. 2 is a top plan view thereof;

FIG. 3 is a front elevation view thereof;

FIG. 4 is a right side elevation view thereof;

FIG. 5 is a rear elevation view thereof;

FIG. 6 is a left side elevation view thereof; and,

FIG. 7 is a bottom plan view thereof.

The broken lines shown in the drawings depict portions of the toolbox that form no part of the claimed design.

1 Claim, 7 Drawing Sheets

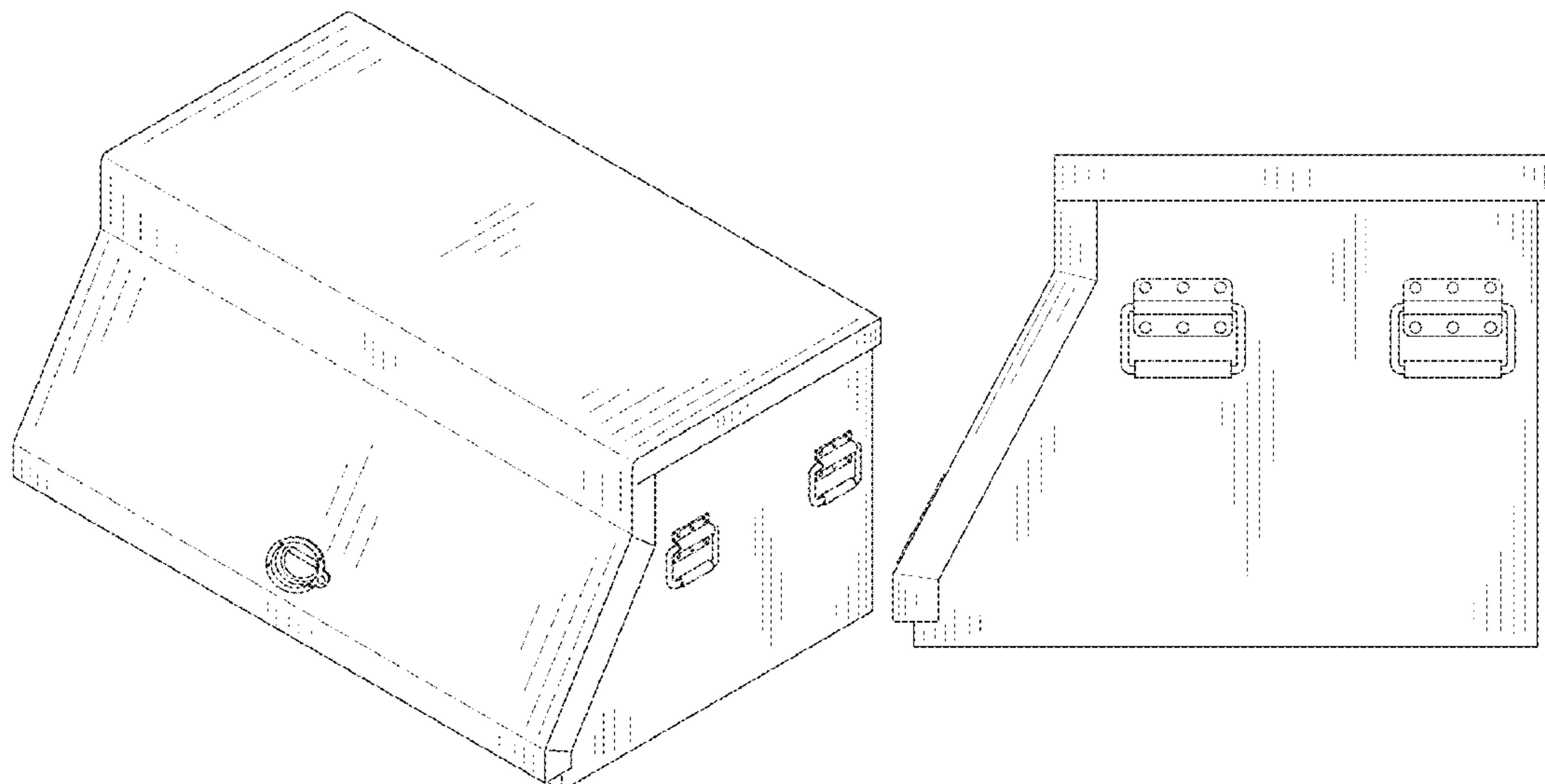

(56)

References Cited

U.S. PATENT DOCUMENTS

5,660,299 A * 8/1997 Harvey A45C 11/20
 220/524
 D384,934 S * 10/1997 Grisel D12/424
 D386,904 S * 12/1997 Bradshaw, Jr. D3/273
 D412,057 S * 7/1999 Brown D3/206
 D486,306 S * 2/2004 Wolf D3/903
 D515,313 S * 2/2006 Uffner D3/273
 D524,541 S * 7/2006 Cauley D3/905
 D587,898 S * 3/2009 Cetera D3/203.2
 D590,325 S * 4/2009 Hall D12/423
 D630,015 S * 1/2011 Weng D3/276
 D634,561 S * 3/2011 Preussner-Pfaff D6/663
 D649,377 S * 11/2011 Manalang D6/670
 D677,934 S * 3/2013 Grela D6/670
 D740,360 S * 10/2015 Chen D18/99
 D777,428 S * 1/2017 Hsu D3/273
 D779,200 S * 2/2017 Caglar D3/276
 D838,479 S * 1/2019 Felsenthal D3/294
 D845,038 S * 4/2019 Waldner D6/670
 D929,735 S * 9/2021 Cruice D27/189
 2005/0285489 A1 * 12/2005 Brother A47L 23/16
 312/235.5
 2016/0144502 A1 * 5/2016 Perkins B25H 3/028
 206/349

FOREIGN PATENT DOCUMENTS

CN 305865651 * 6/2020
 CN 306931943 * 11/2021

OTHER PUBLICATIONS

Facebook Post, available at facebook.com, posted Oct. 2, 2019 [online], site visited Feb. 18, 2022, available from the internet URL: <https://www.facebook.com/BaumBox-Toolboxes-LLC-1939502973027995/photos/2298986117079677> (Year: 2019).*

Montezuma, available at amazon.com, earliest customer review date Nov. 8, 2008 [online], site visited Feb. 18, 2022, available from the internet URL: <https://www.strictlytoolboxes.com/best-selling-tool-boxes/best-sellers/montezuma-professional-portable-tool-box-sm200b-small-22-1-2-x-13.html?> (Year: 2008).*

Toolbox, available at johndeerestore.com [online], site visited Feb. 18, 2022, available from internet URL: <https://www.johndeerestore.com/jdb2cstorefront/JohnDeereStore/en/John-Deere-products/Workshop/Tools/Tool-Storage-%26-Safes/Portable-Triangle-Toolbox---Green-%28AC-2313TB-G%29/p/MTMAC2313TBG> (Year: 2022).*

36" Diamond Plate Aluminum Saddle Tool Box With Step, available at raneystruckparts.com, earliest customer review date Feb. 27, 2021 [online], site visited Feb. 18, 2022, available from the internet URL: <https://www.raneystruckparts.com/36-diamond-plate-aluminum-saddle-tool-box-with-step/?>.*

* cited by examiner

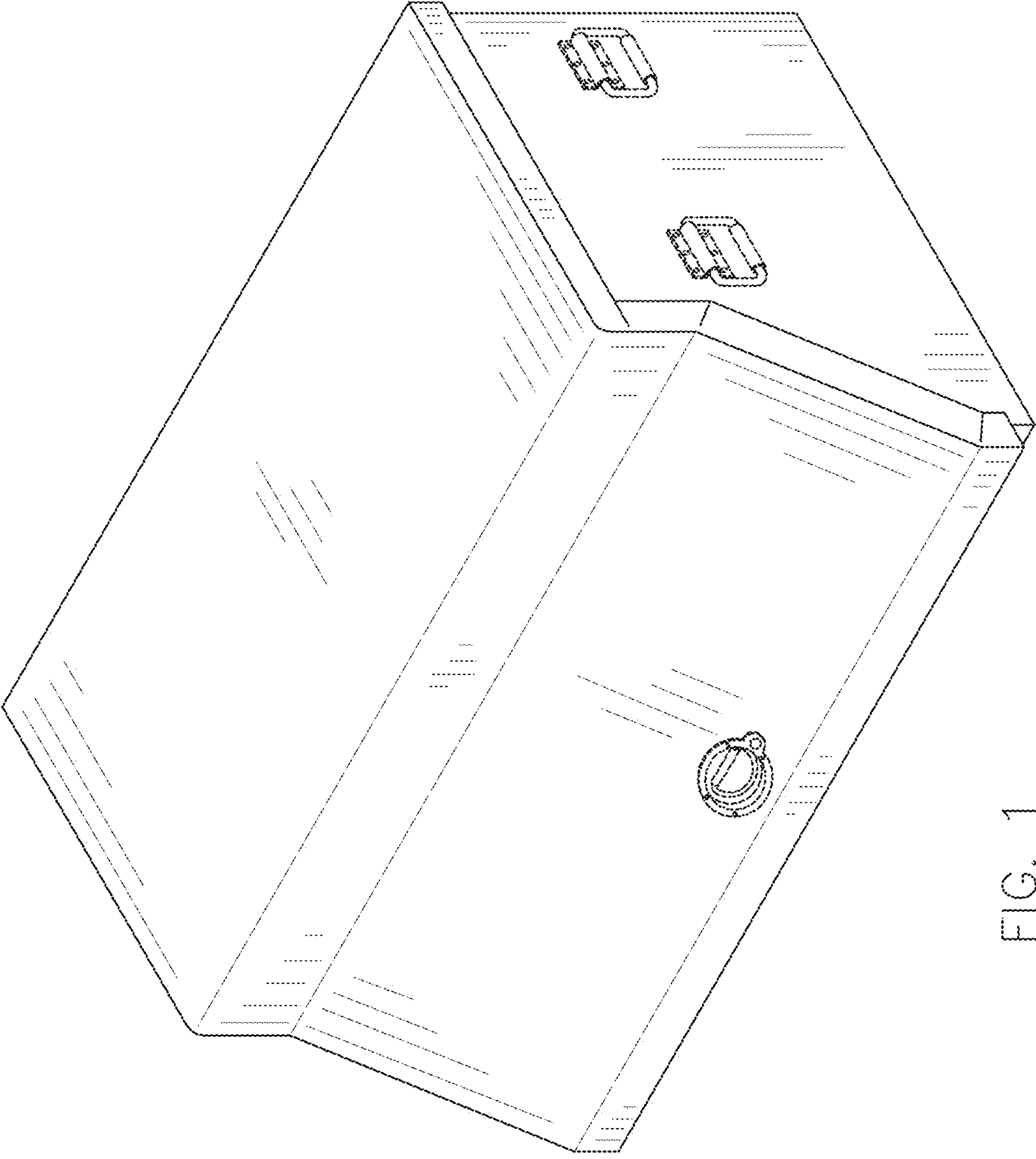

FIG. 1

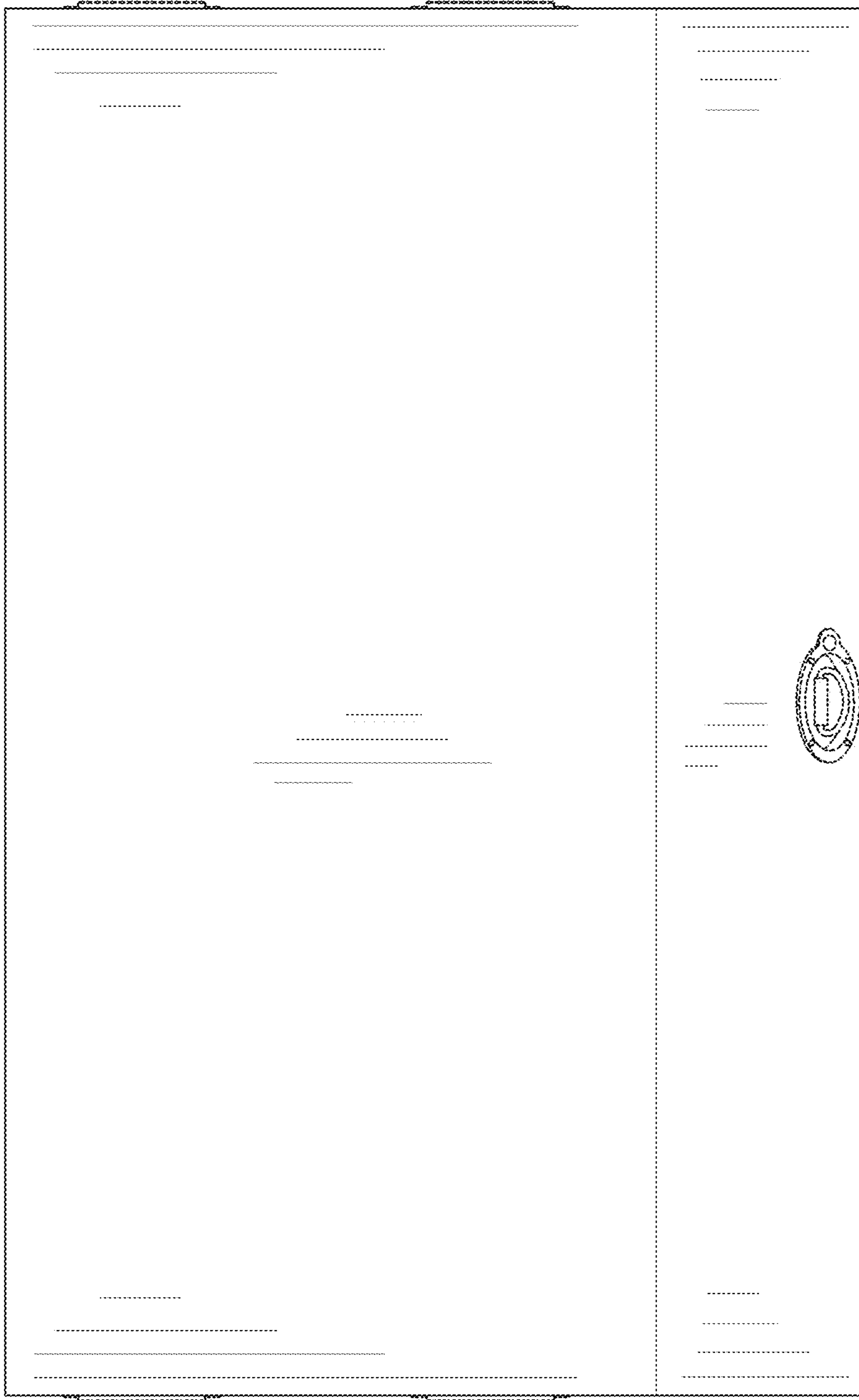

FIG. 2

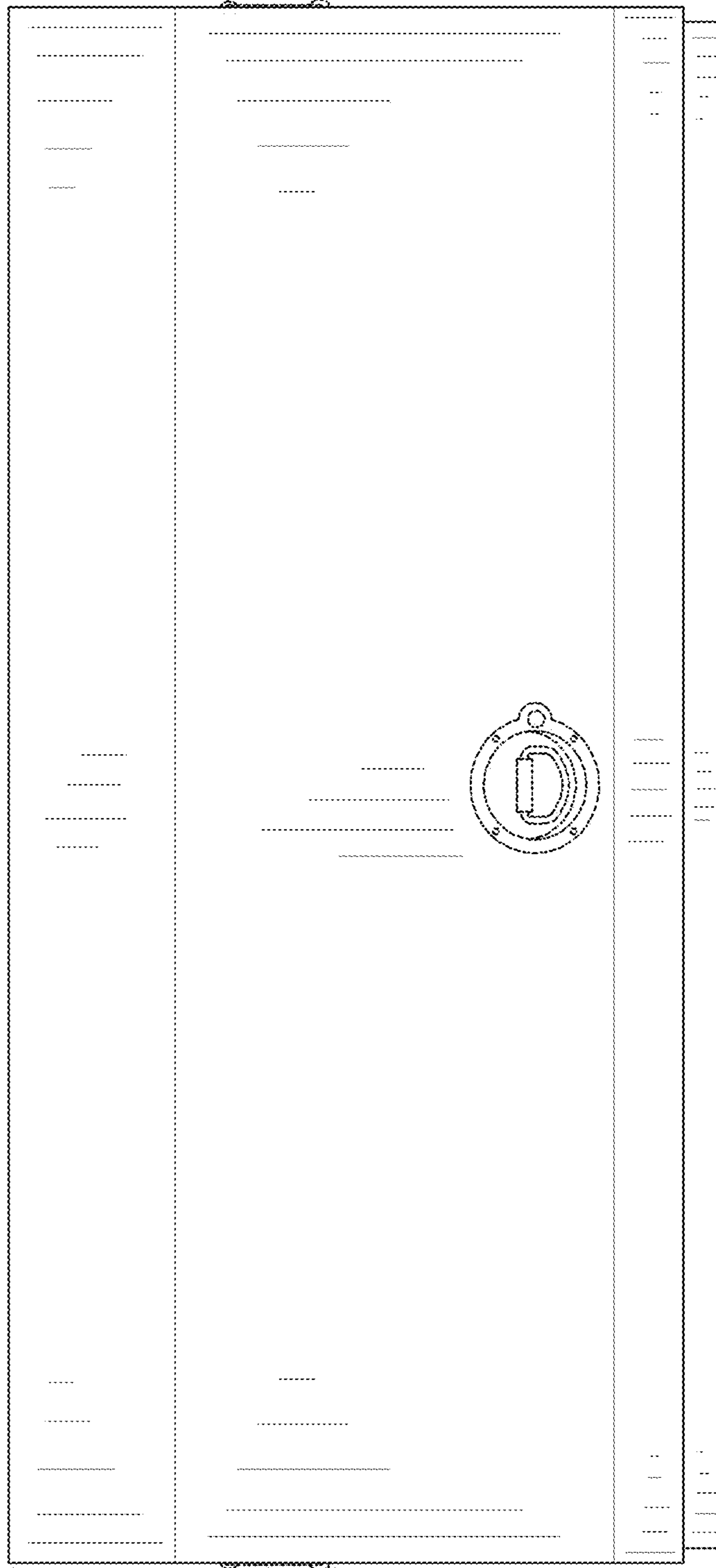

FIG. 3

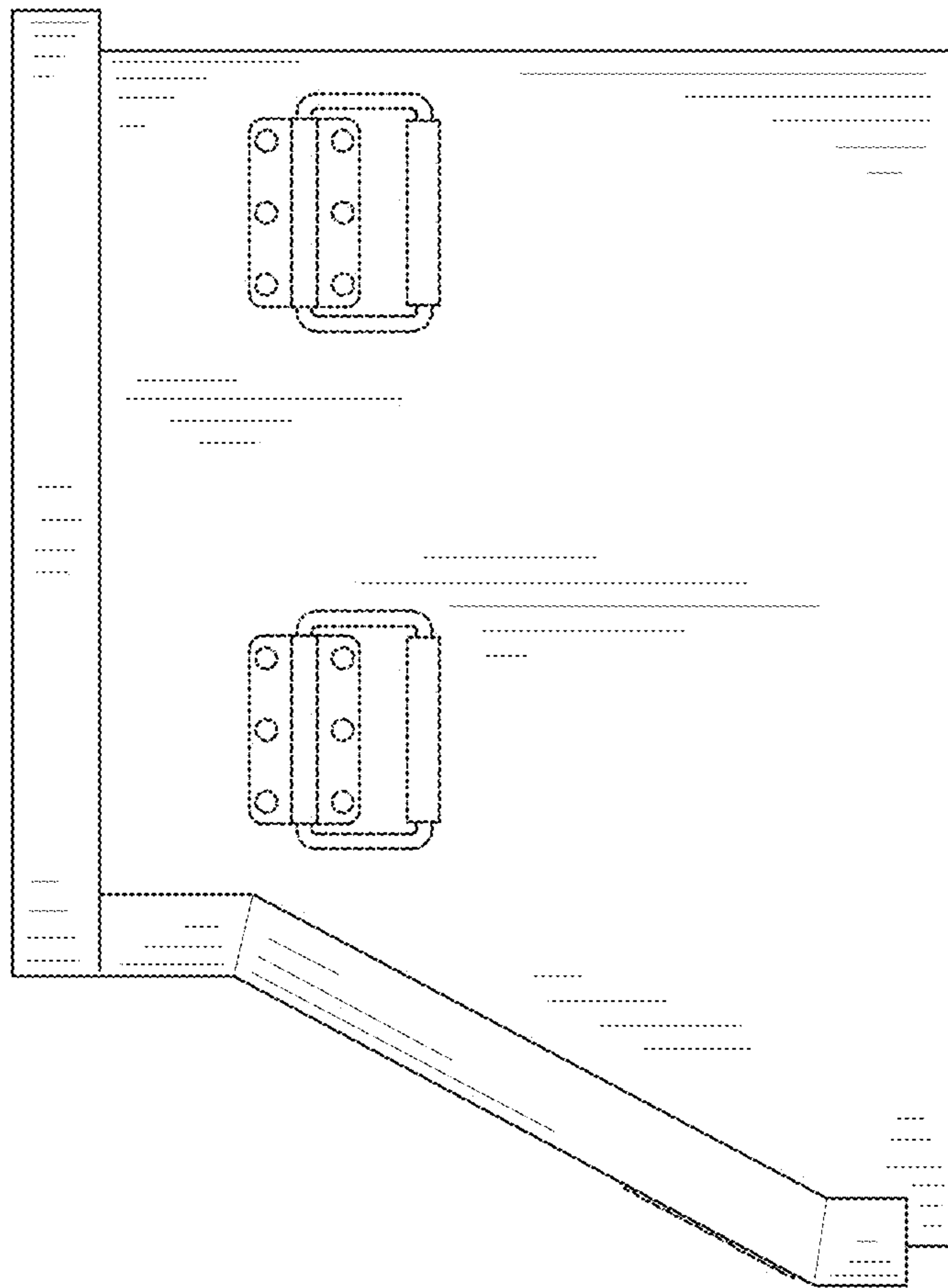

FIG. 4

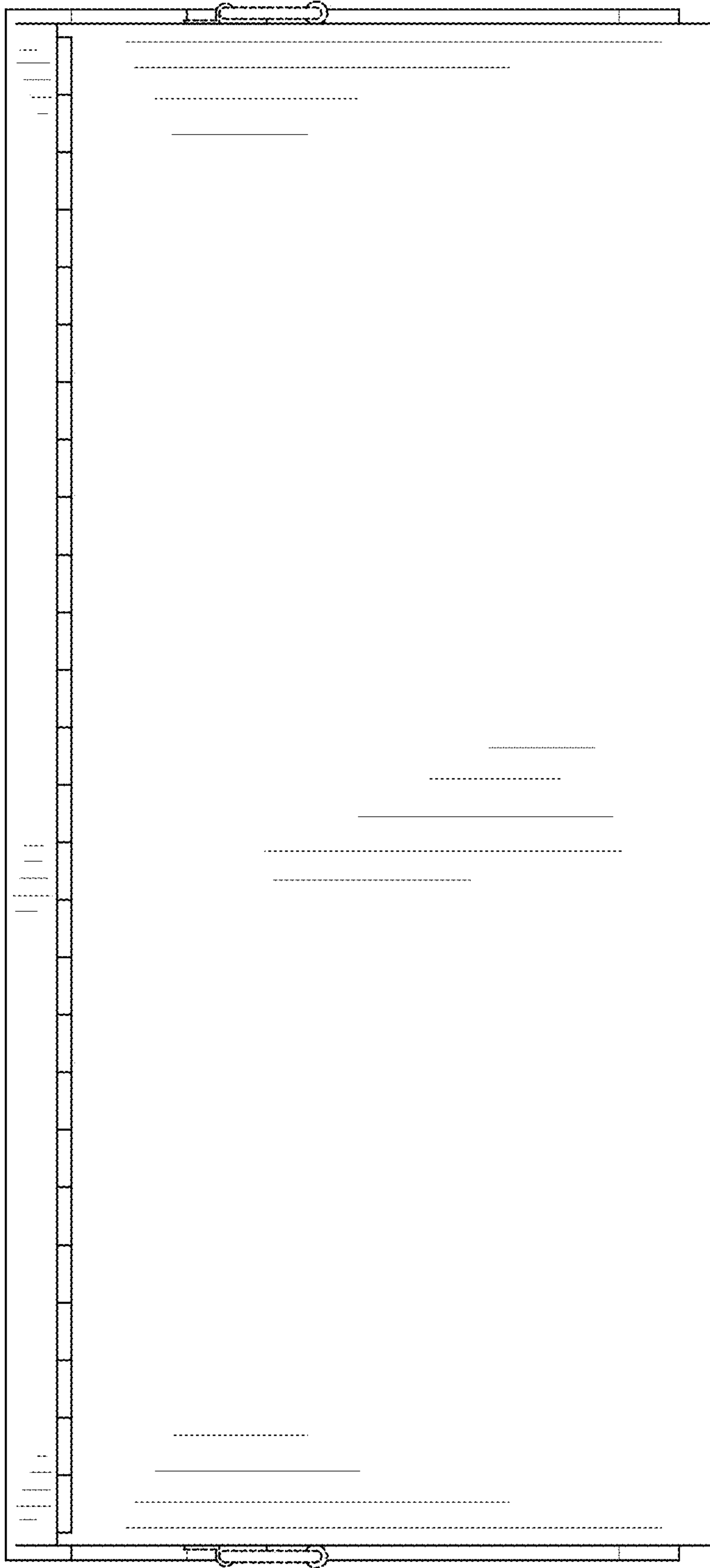

FIG. 5

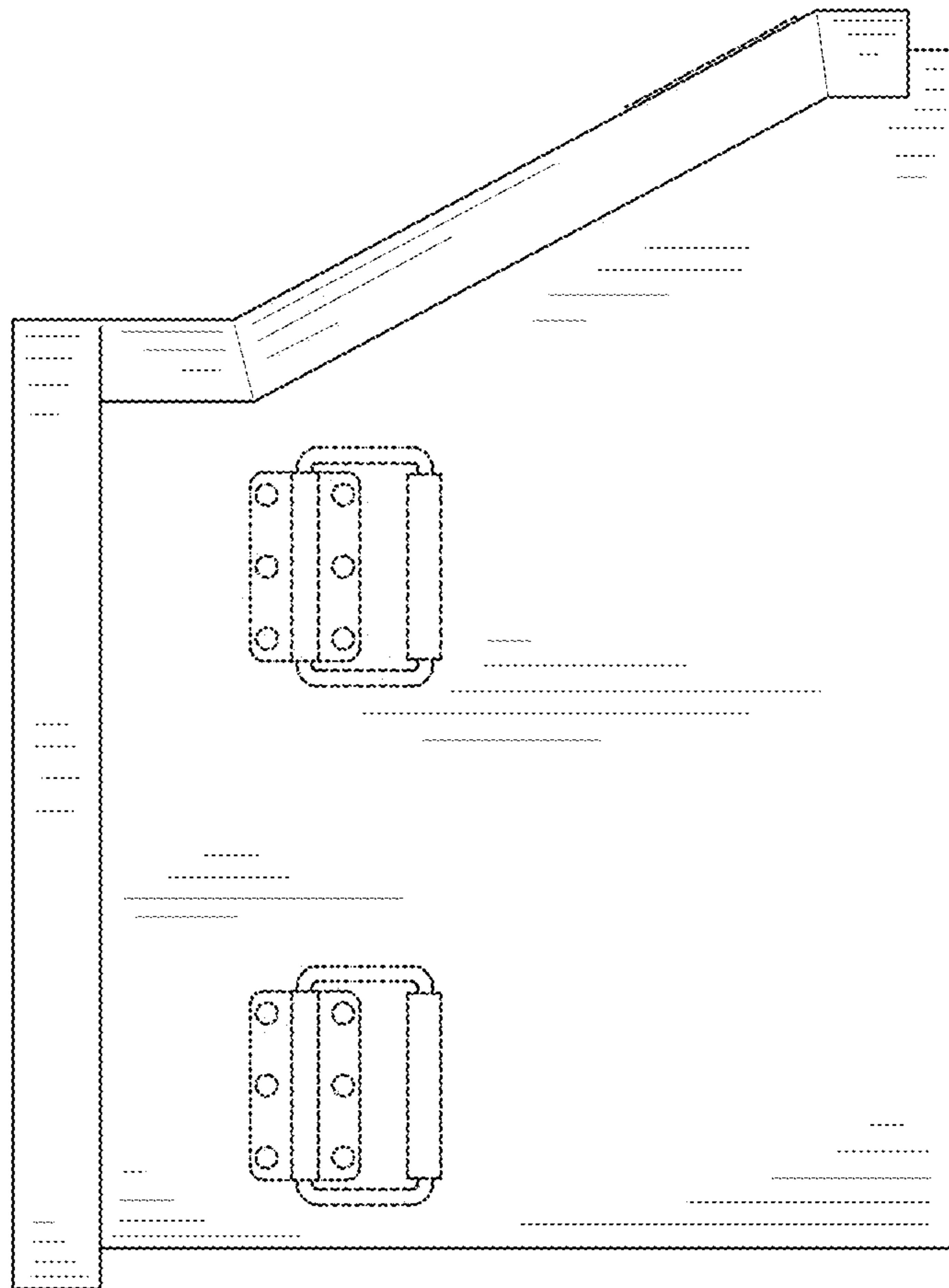

FIG. 6

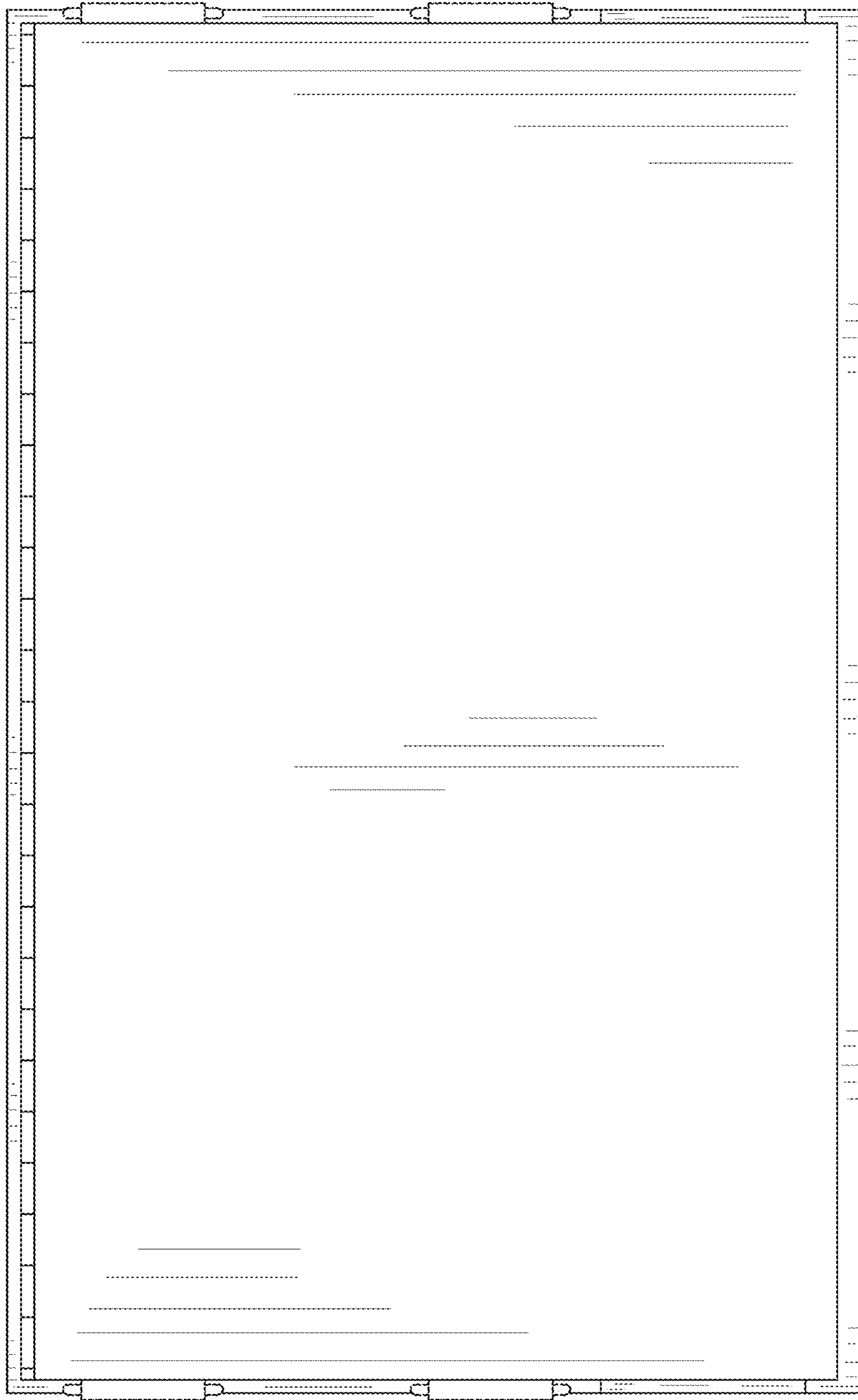

FIG. 7