



US00D975404S

(12) **United States Design Patent** (10) **Patent No.:** **US D975,404 S**  
**Guo** (45) **Date of Patent:** **\*\* Jan. 17, 2023**

(54) **HAT WITH LIGHT**

- (71) Applicant: **Guanghuo Guo**, Ganzhou (CN)
- (72) Inventor: **Guanghuo Guo**, Ganzhou (CN)
- (73) Assignee: **Guanghuo Guo**, Ganzhou (CN)
- (\*\*) Term: **15 Years**

(21) Appl. No.: **29/806,763**

(22) Filed: **Sep. 7, 2021**

(51) **LOC (14) Cl.** ..... **02-03**

(52) **U.S. Cl.**

USPC ..... **D2/866; D2/882**

(58) **Field of Classification Search**

USPC ..... D2/865, 866, 875, 876, 877, 878, 879,  
D2/880, 881, 882, 883, 884, 885, 886,  
D2/887, 888, 891, 893

CPC ..... A42B 1/00; A42B 1/002; A42B 1/004;  
A42B 1/006; A42B 1/02; A42B 1/062;  
A42B 1/063; A42B 1/201; A42B 1/225;  
A42C 5/00; A42C 5/04; H04R 1/02;  
H04R 1/105

See application file for complete search history.

(56) **References Cited**

**U.S. PATENT DOCUMENTS**

6,175,963	B1 *	1/2001	Loeffelholz	.....	A42B 1/248 2/200.1
6,240,568	B1 *	6/2001	Lee	.....	A41D 27/08 40/329
6,302,570	B1 *	10/2001	Petell	.....	G09F 9/305 362/570
D460,604	S *	7/2002	Sullivan, Jr.	.....	D2/882
D501,979	S *	2/2005	Lundgren	.....	D2/866
D517,283	S *	3/2006	Shin	.....	D2/865
8,009,847	B2 *	8/2011	Planansky	.....	A42B 1/245 381/301
8,121,335	B2 *	2/2012	Sharpe	.....	A42B 1/248 381/376

(Continued)

**OTHER PUBLICATIONS**

Touch Two Baseball Cap with Light 125 Lumens . . . [online]; [date first available to the internet on Oct. 19, 2021]; [retrieved from the internet on Sep. 30, 2022]; URL: [https://www.amazon.com/dp/B09JSHRYSQ/ref=sspa\\_dk\\_detail\\_1?psc=1&pd\\_rd\\_i=B09JSHRYSQ&pd\\_rd\\_w=DgLf2&content-id=amzn1.sym.46bad5f6-1f0a-4167-9a8b-c8a82fa48a54&pf\\_rd\\_p=46bad5f6-1f0a-4167-9a8b-c8a82fa48a54&pf\\_rd\\_r=SRMVCM16PY258BW7PWYQ&pd\\_rd\\_wg=pZ3cX&pd\\_rd\\_r=dbc2ec33-0ada-4def-b6b0-2f448bdd0805&s=home-garden&sp\\_csd=d2lkZ](https://www.amazon.com/dp/B09JSHRYSQ/ref=sspa_dk_detail_1?psc=1&pd_rd_i=B09JSHRYSQ&pd_rd_w=DgLf2&content-id=amzn1.sym.46bad5f6-1f0a-4167-9a8b-c8a82fa48a54&pf_rd_p=46bad5f6-1f0a-4167-9a8b-c8a82fa48a54&pf_rd_r=SRMVCM16PY258BW7PWYQ&pd_rd_wg=pZ3cX&pd_rd_r=dbc2ec33-0ada-4def-b6b0-2f448bdd0805&s=home-garden&sp_csd=d2lkZ) (4 pages). (Year: 2021).\*

*Primary Examiner* — Jasmine Mlinarcik

(74) *Attorney, Agent, or Firm* — Nitin Kaushik

(57) **CLAIM**

The ornamental design for a hat with light, as shown and described.

**DESCRIPTION**

FIG. 1 is a perspective view of a hat with light showing my new design;  
FIG. 2 is another perspective view thereof;  
FIG. 3 is a front elevational view thereof;  
FIG. 4 is a rear elevational view thereof;  
FIG. 5 is a left side elevational view thereof;  
FIG. 6 is a right side elevational view thereof;  
FIG. 7 is a top plan view thereof;  
FIG. 8 is a bottom plan view thereof;  
FIG. 9 is an enlarged view of portion 9 shown in FIG. 1;  
FIG. 10 is an enlarged view of portion 10 shown in FIG. 2;  
FIG. 11 is an enlarged view of portion 11 shown in FIG. 2;  
FIG. 12 is an enlarged view of portion 12 shown in FIG. 2;  
and,  
FIG. 13 is an enlarged view of portion 13 shown in FIG. 2.  
The dash-dash broken lines in the drawings depict portions of the hat with light that form no part of the claimed design. The dot-dash broken lines represent boundaries of the enlarged portions and form no part of the claimed design.

**1 Claim, 13 Drawing Sheets**

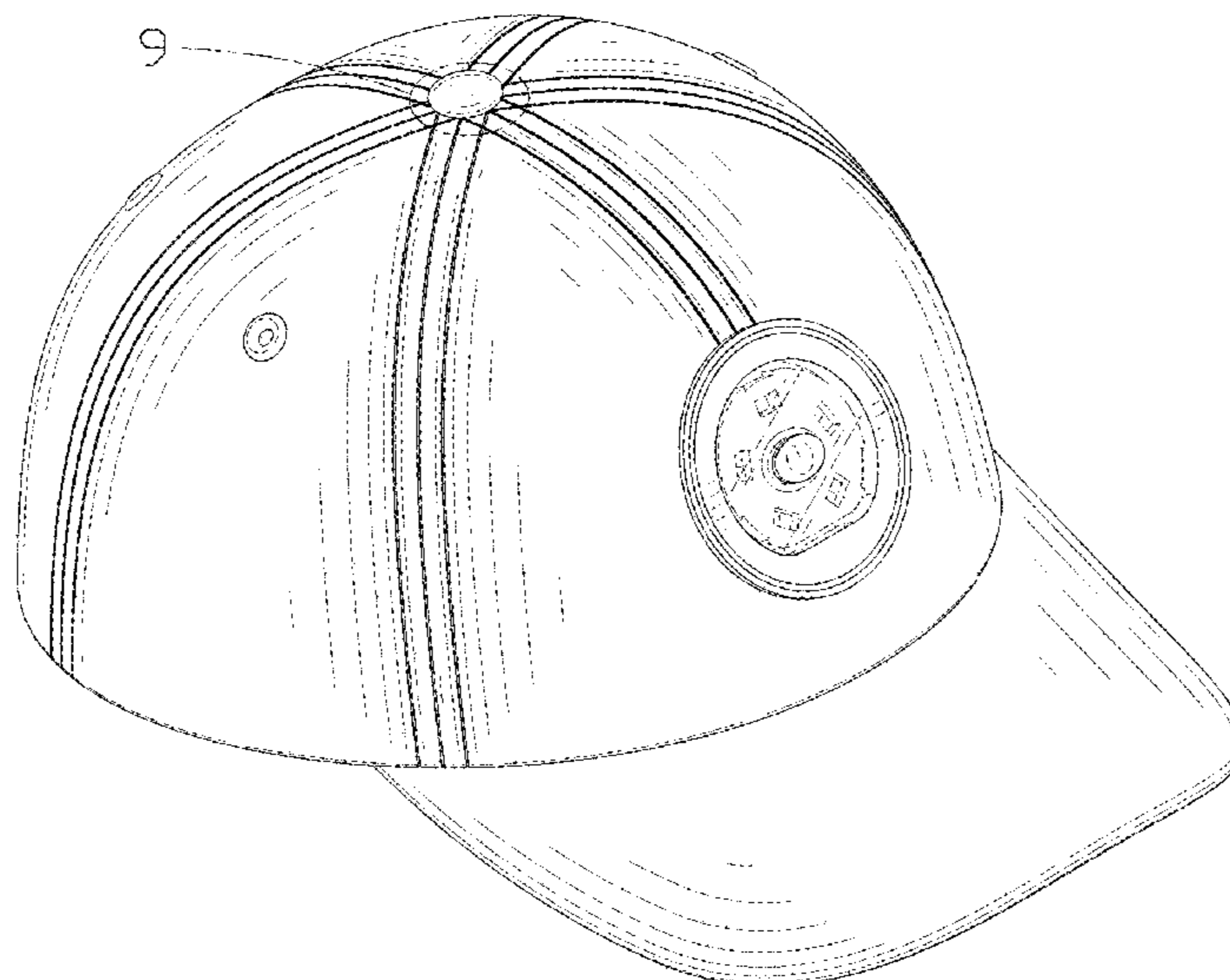

(56)

**References Cited**

U.S. PATENT DOCUMENTS

D788,413 S	6/2017	Moore	
D808,623 S	1/2018	Scartezini	
10,492,554 B2 *	12/2019	Sears .....	A42B 1/248
D917,135 S *	4/2021	Hickenbotham .....	D2/882
2010/0299979 A1 *	12/2010	LaMere .....	G09F 21/02 40/329

\* cited by examiner

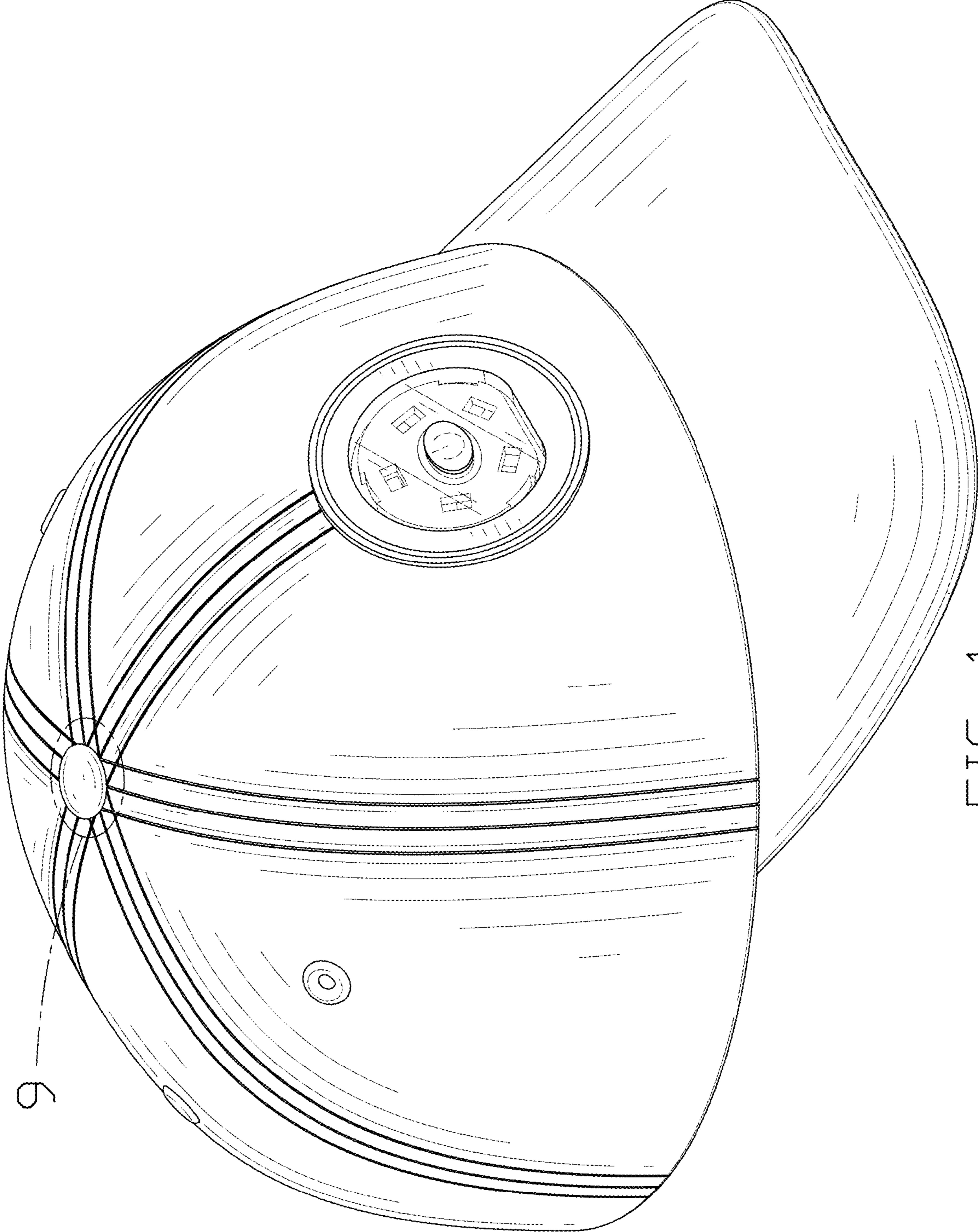

FIG. 1

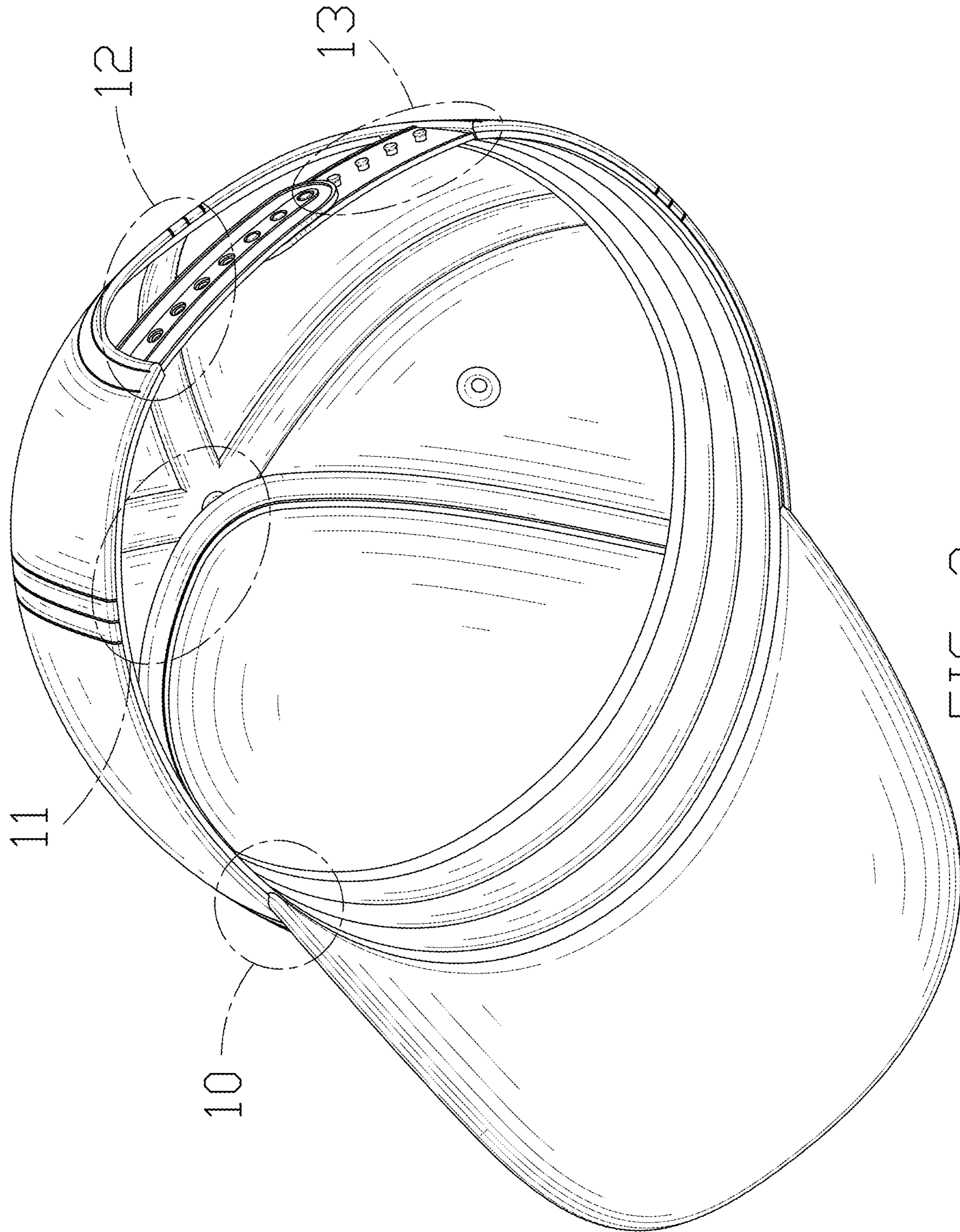

FIG. 2

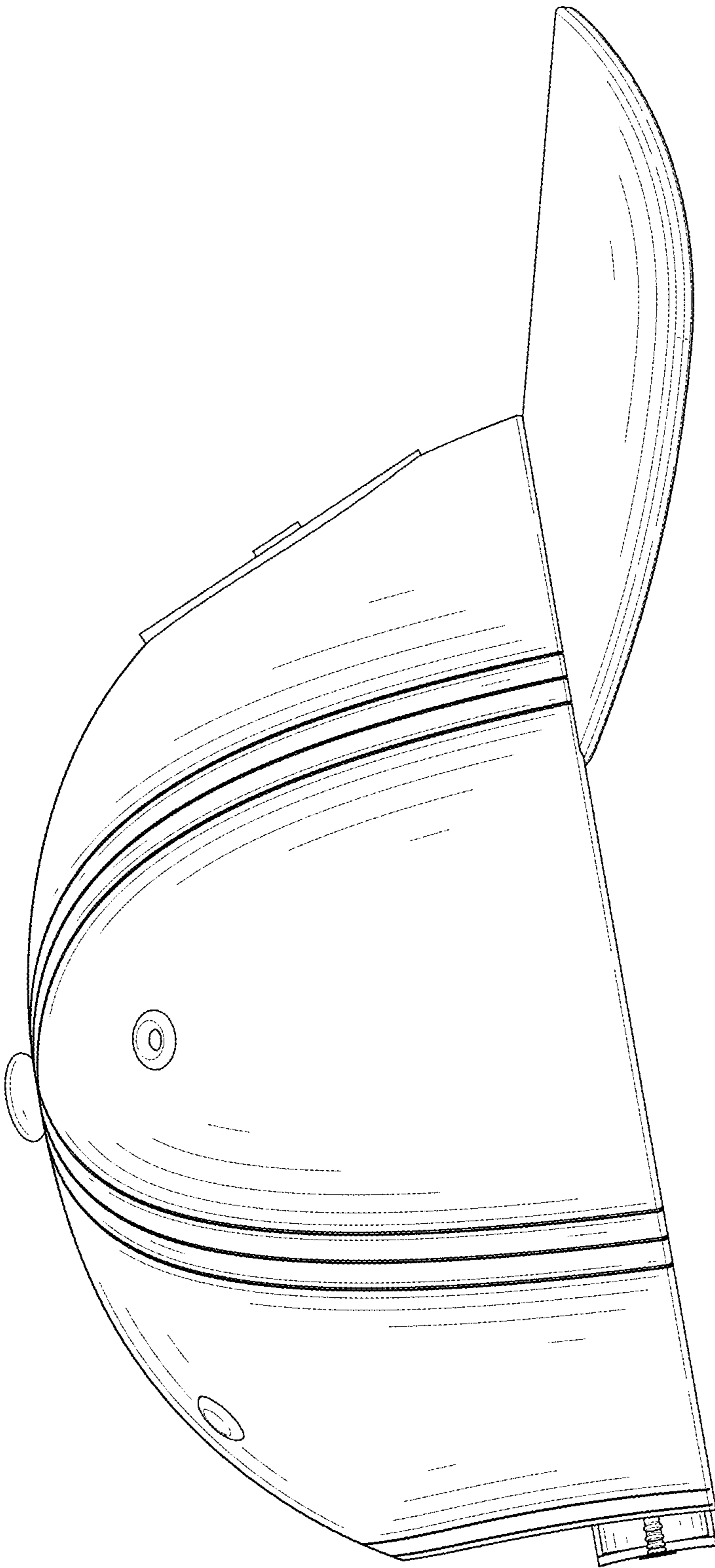

FIG. 3

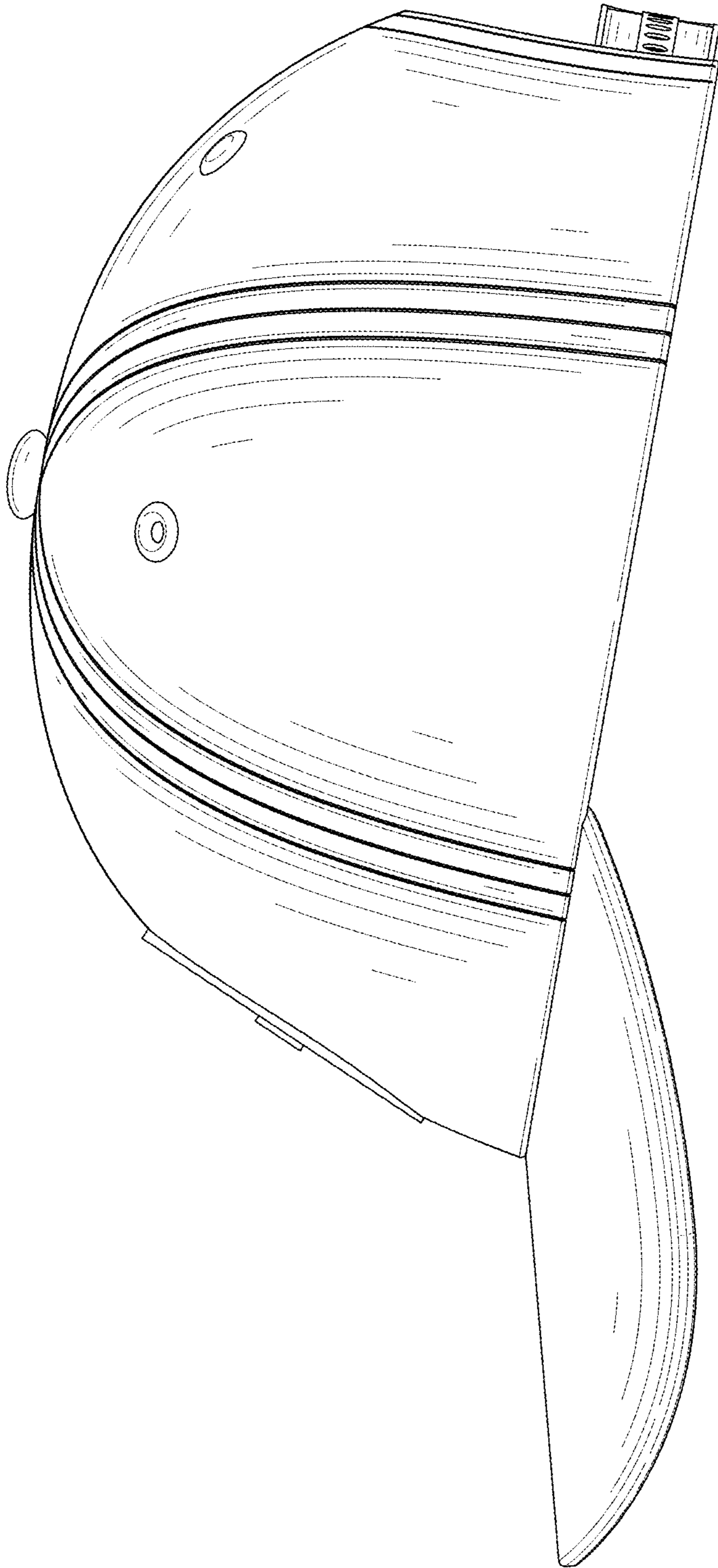

FIG. 4

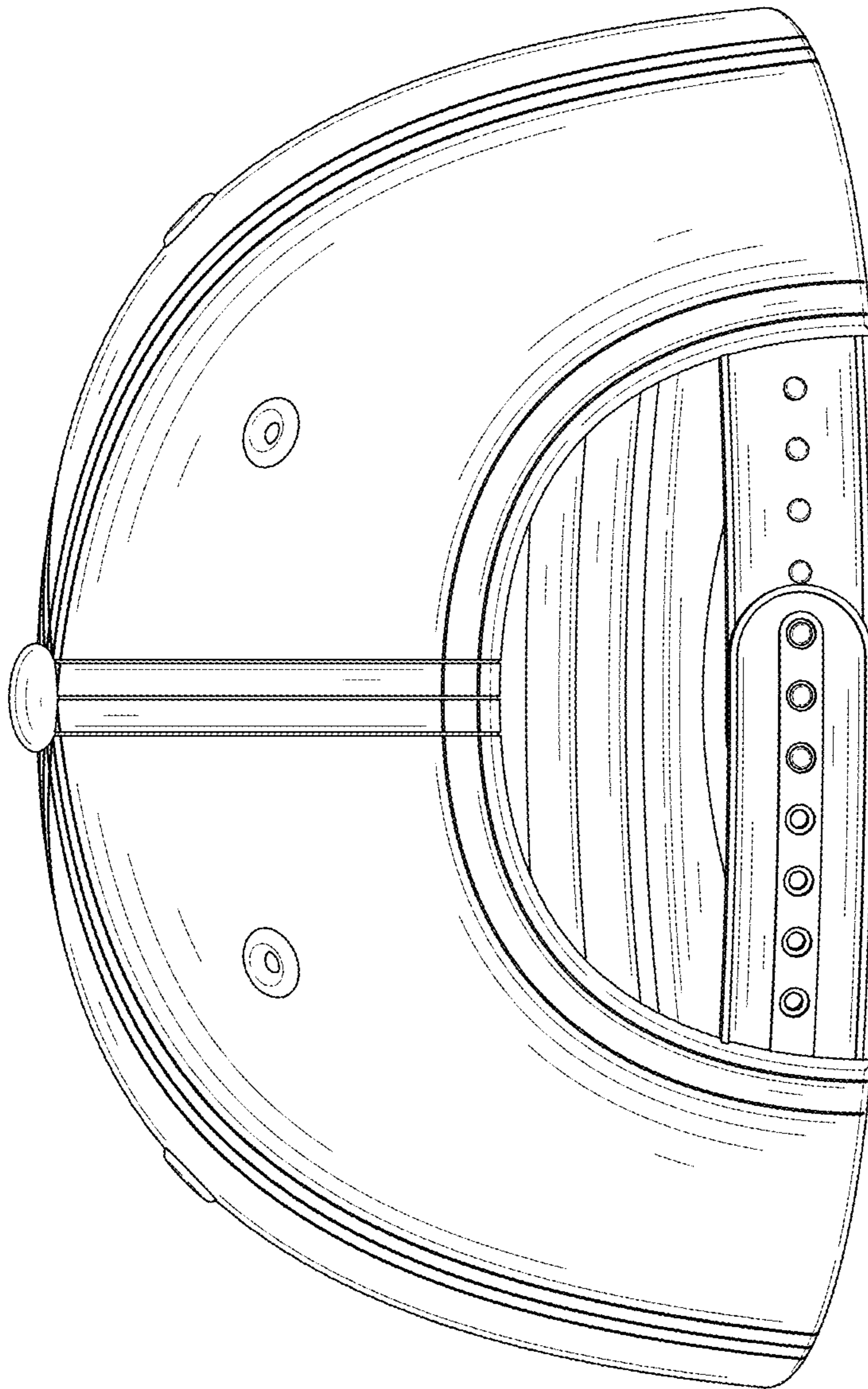

FIG. 5

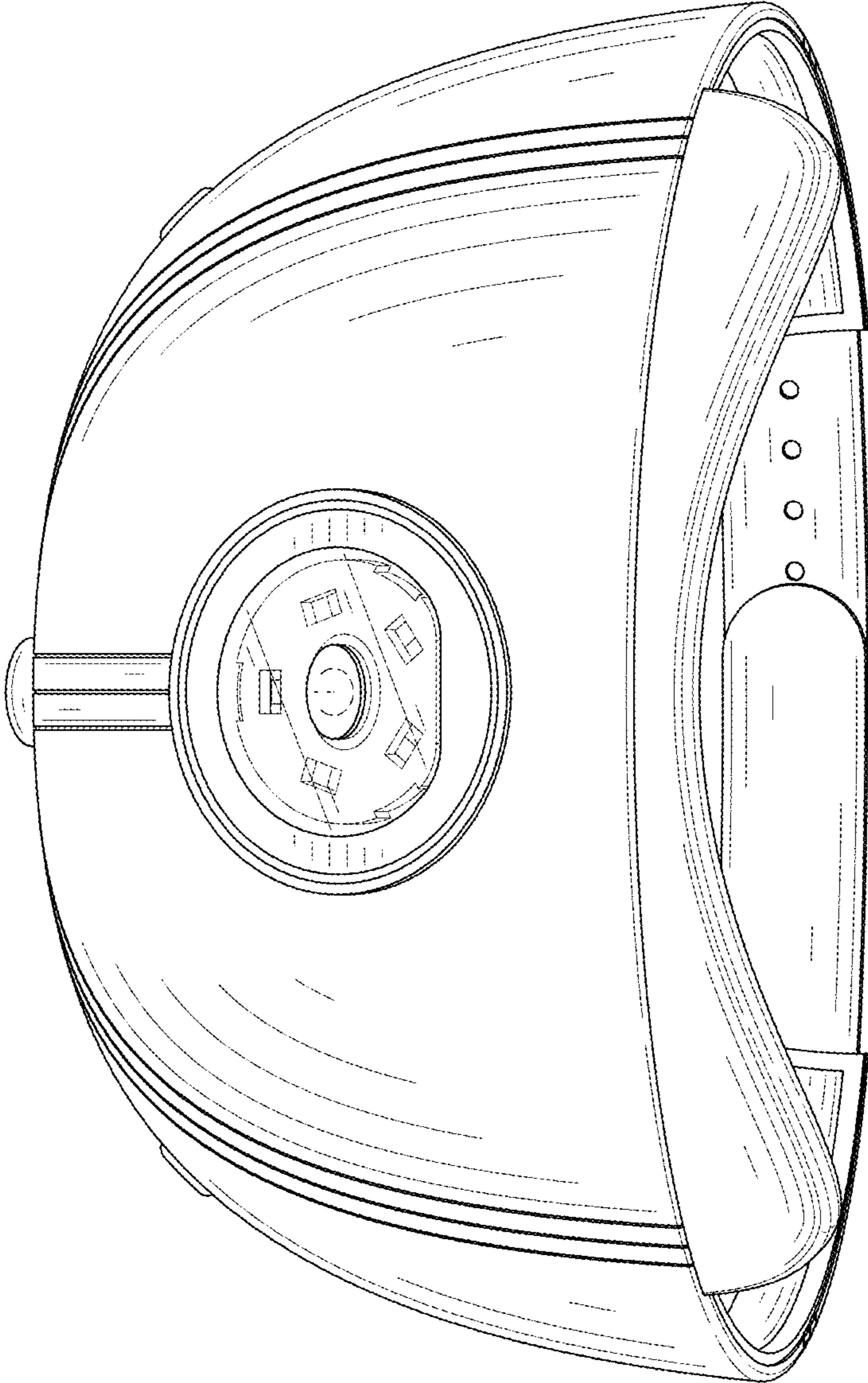

FIG. 6



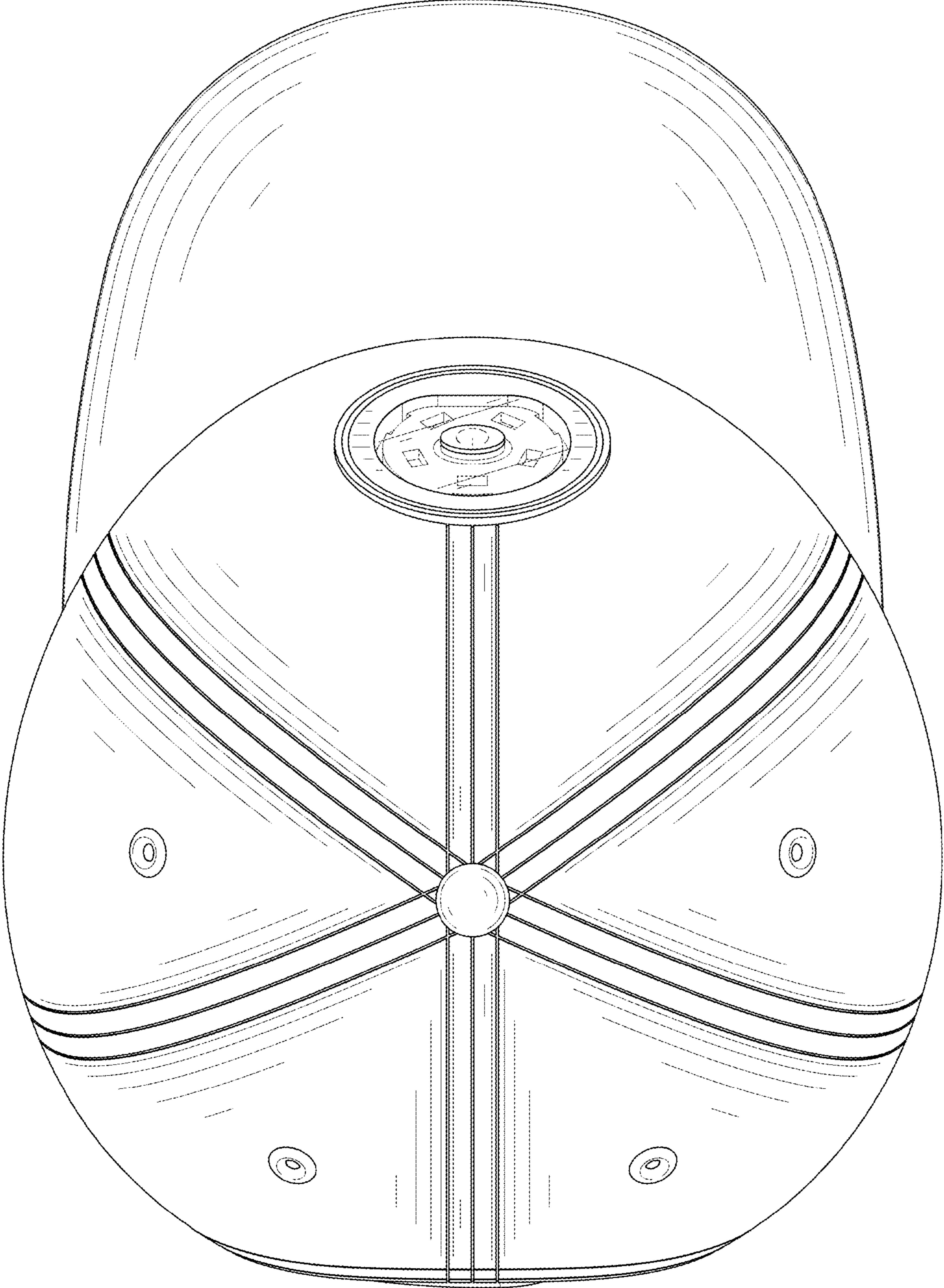

FIG. 7

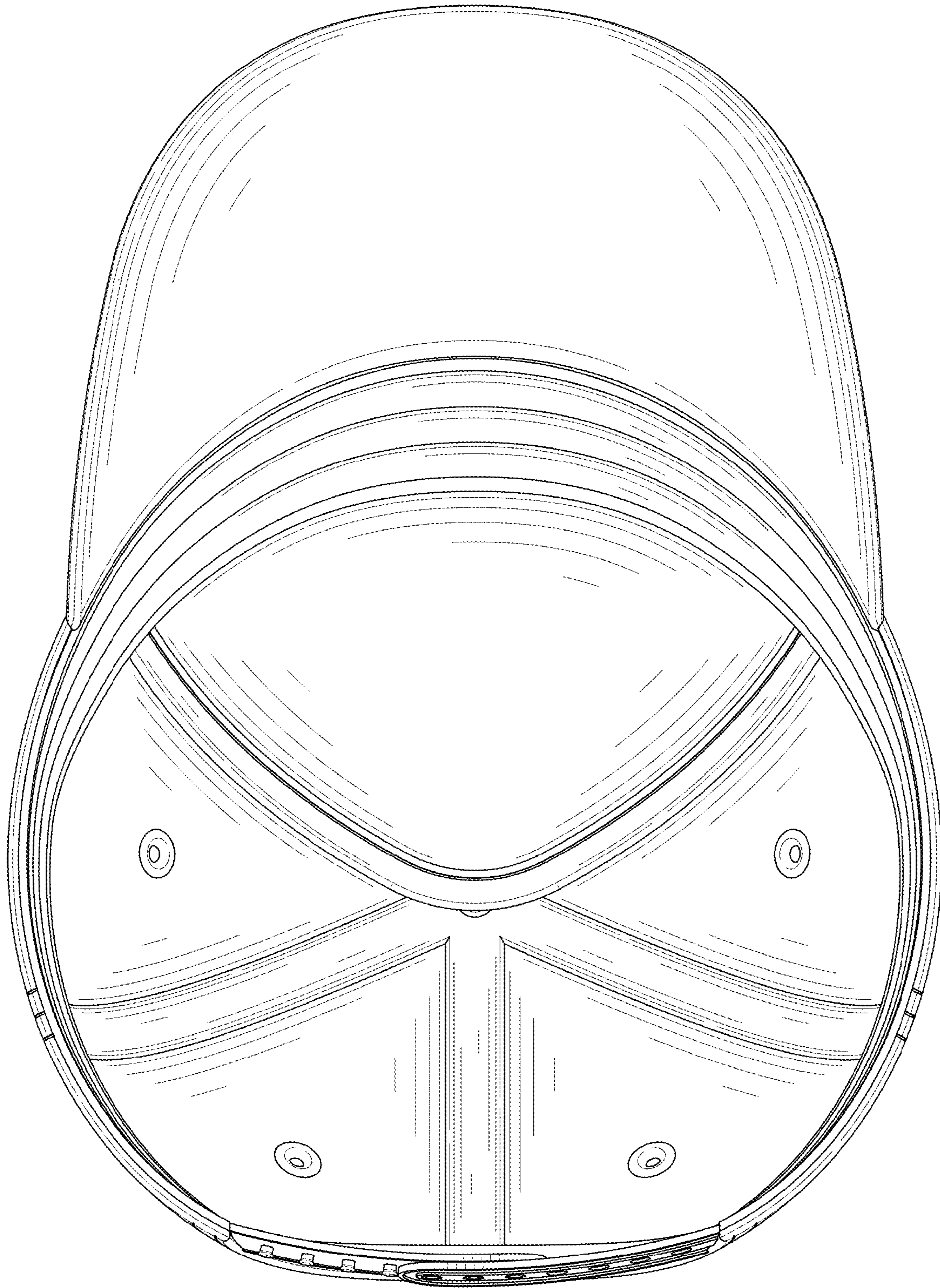

FIG. 8

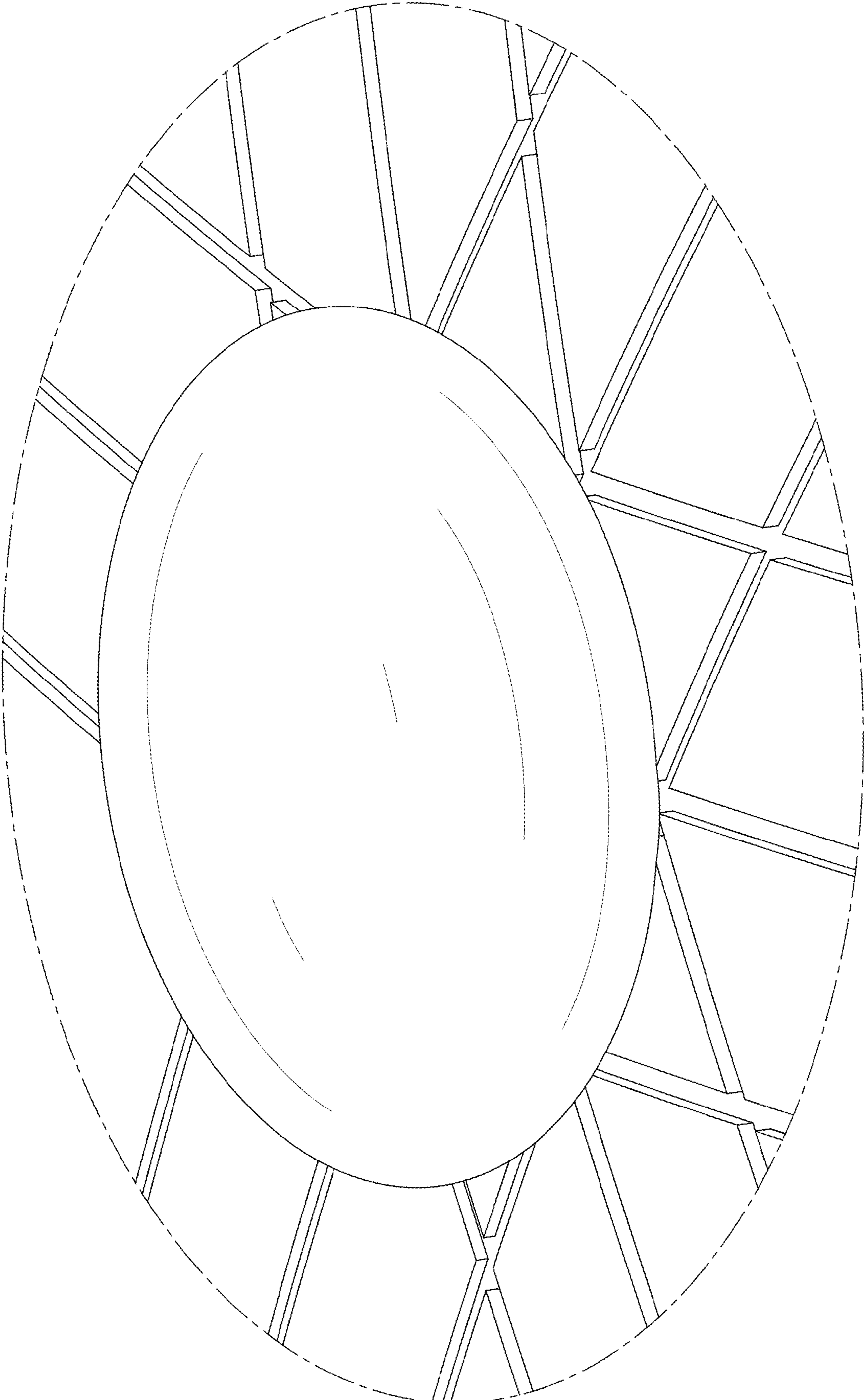

FIG. 9

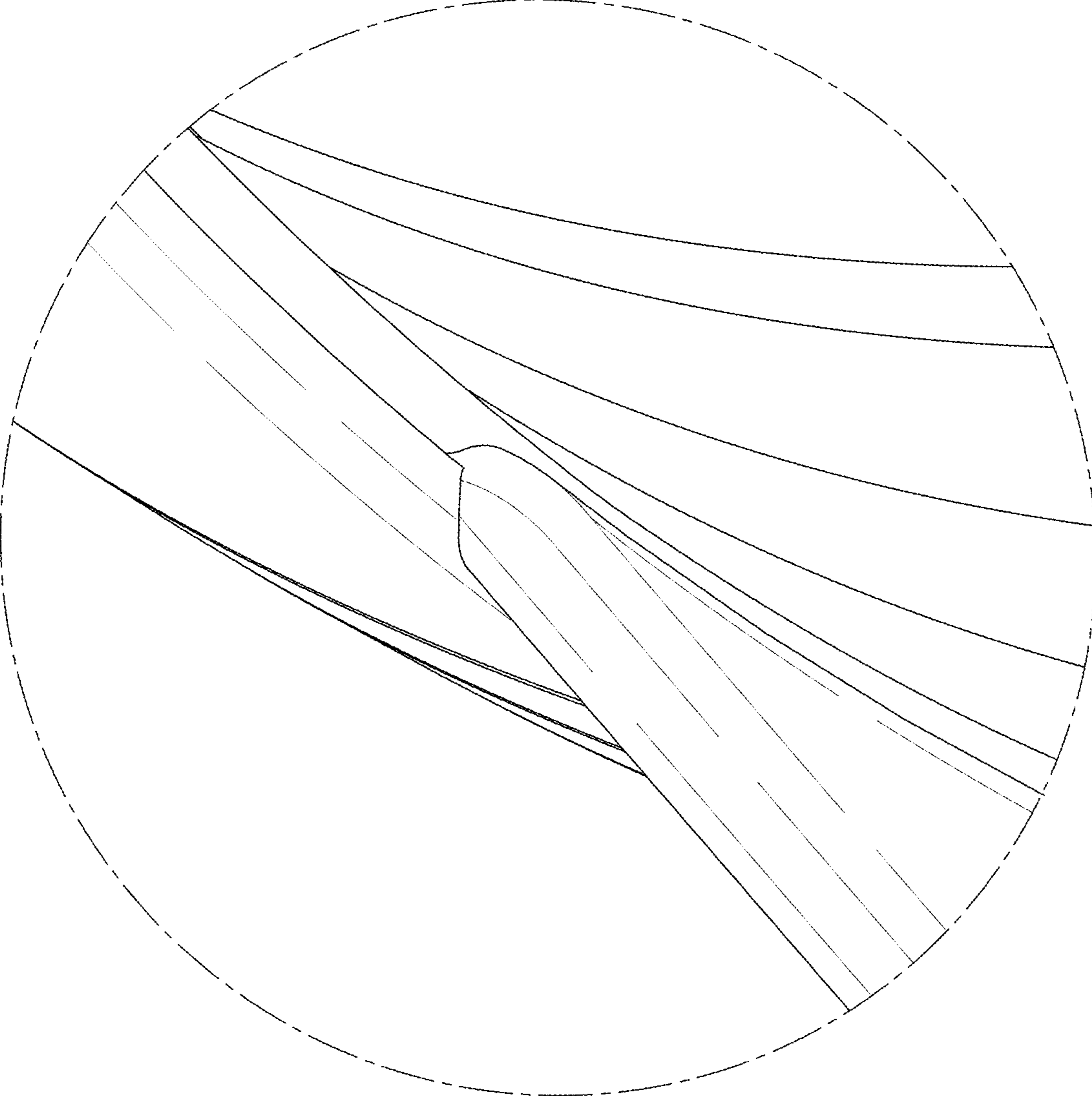

FIG. 10

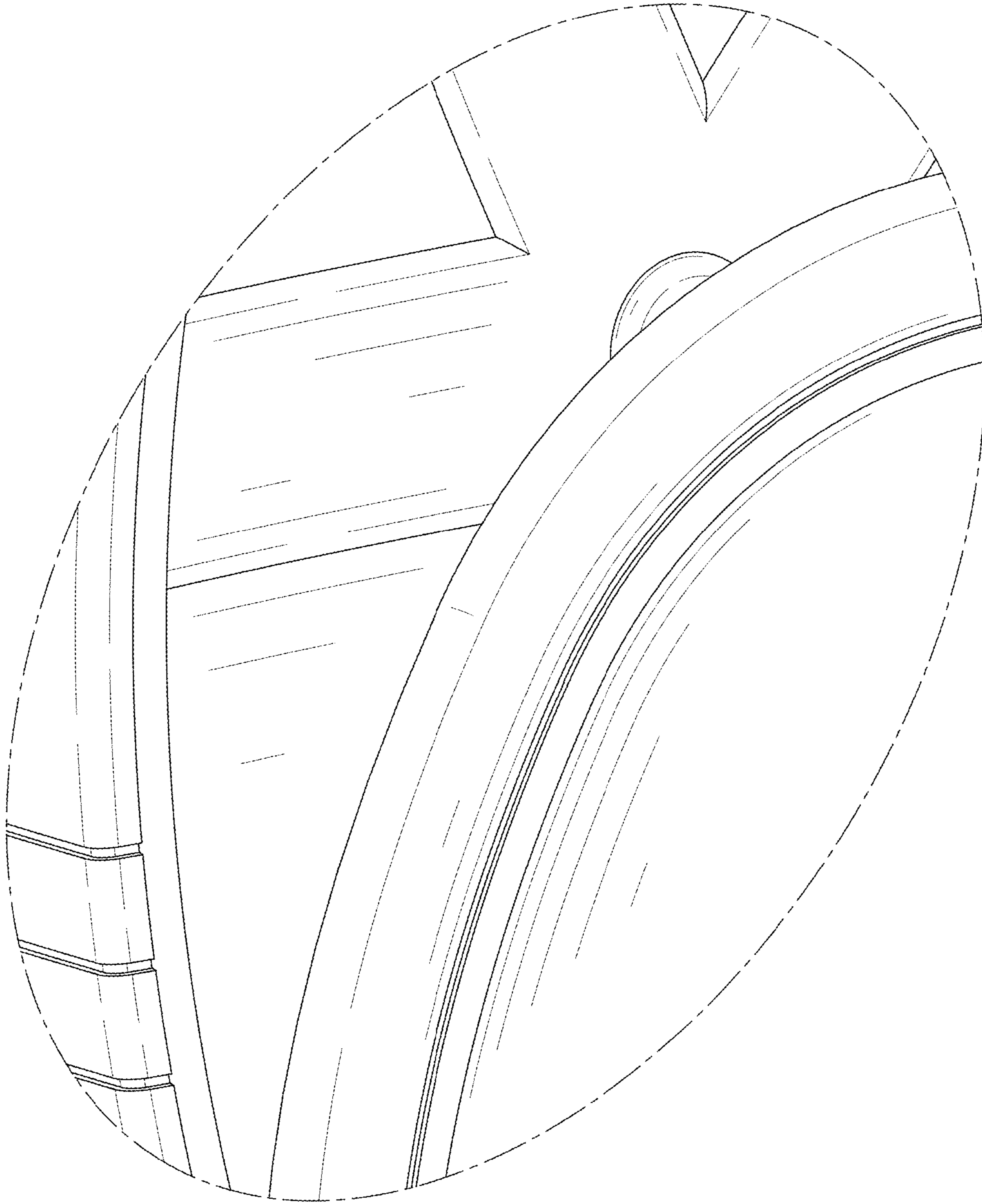

FIG. 11

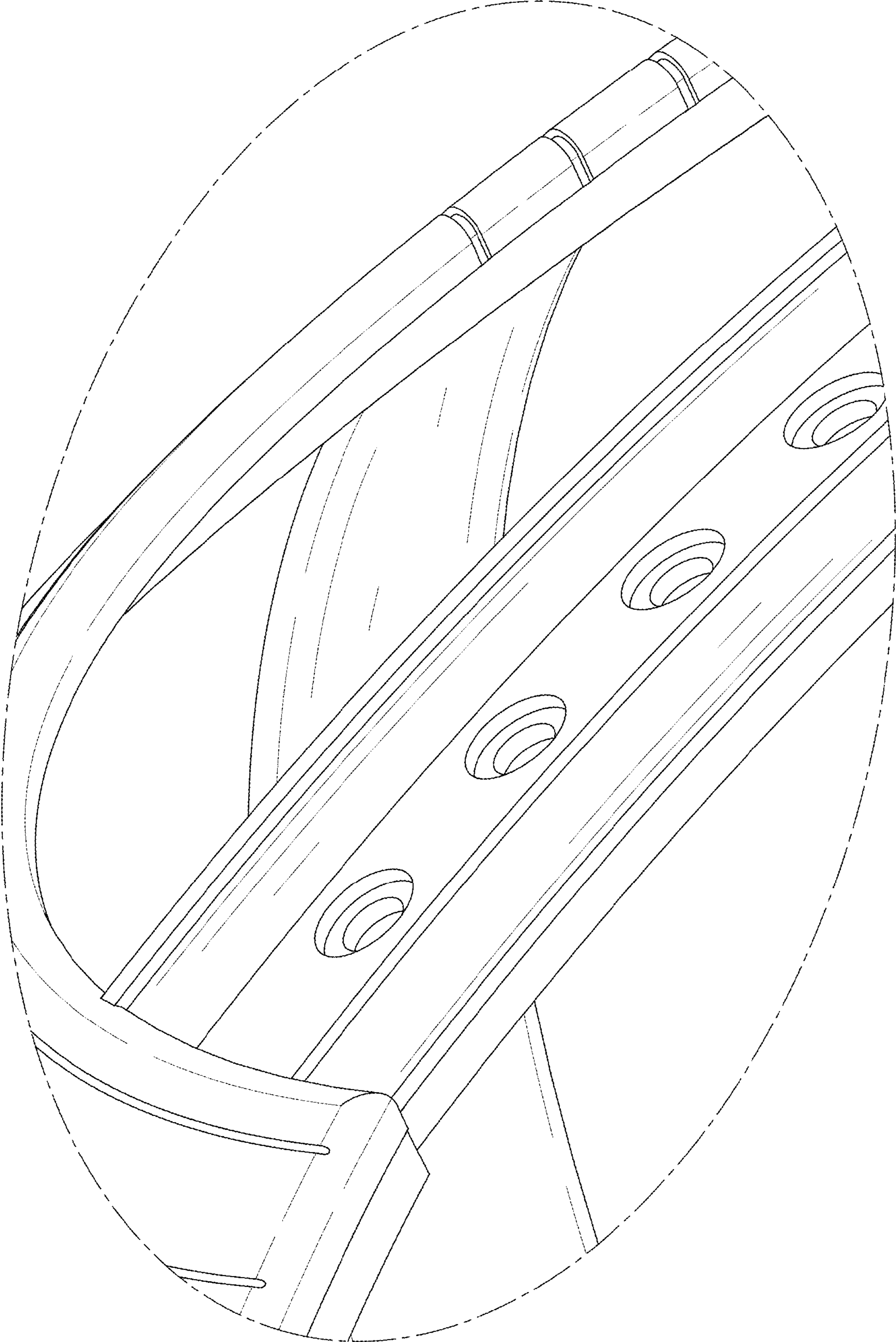

FIG. 12

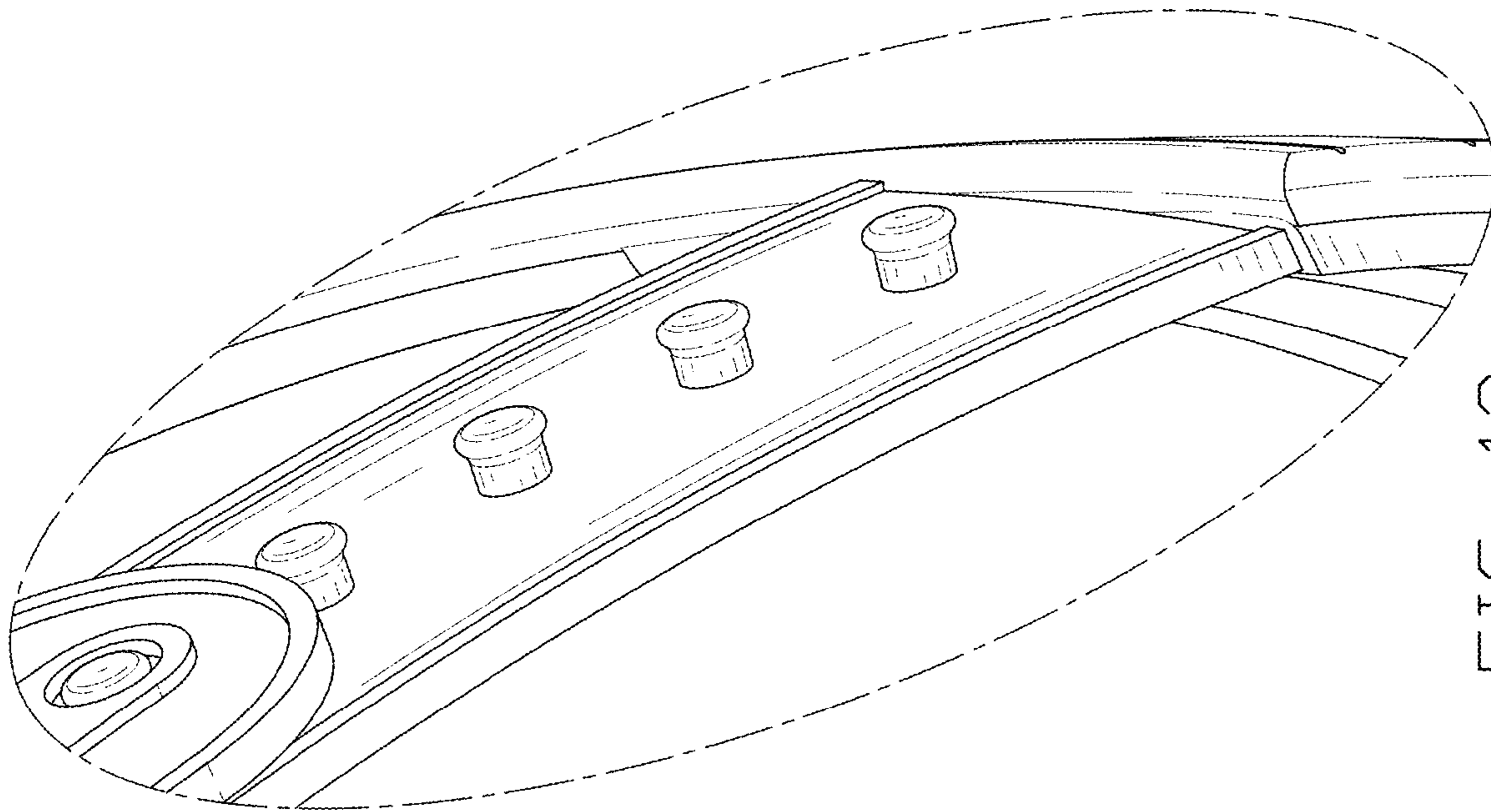

FIG. 13