



US00D975307S

(12) **United States Design Patent**
Takahori

(10) **Patent No.:** **US D975,307 S**
(45) **Date of Patent:** **** Jan. 10, 2023**

(54) **EJACULATION PROMOTION APPARATUS**

(71) Applicant: **TENGA Co., Ltd.**, Tokyo (JP)

(72) Inventor: **Kyohei Takahori**, Tokyo (JP)

(73) Assignee: **TENGA CO., LTD.**, Tokyo (JP)

(**) Term: **15 Years**

(21) Appl. No.: **35/511,686**

(22) Filed: **Oct. 15, 2020**

(80) **Hague Agreement Data**

Int. Filing Date: **Oct. 15, 2020**

Int. Reg. No.: **DM/210966**

Int. Reg. Date: **Oct. 15, 2020**

Int. Reg. Pub. Date: **Apr. 16, 2021**

(30) **Foreign Application Priority Data**

Jul. 6, 2020 (JP) 2020-013753

(51) **LOC (14) Cl.** **24-01**

(52) **U.S. Cl.**
USPC **D24/215**

(58) **Field of Classification Search**

USPC D24/127, 130, 133, 146, 147, 215, 107,
D24/108, 111, 121, 122, 123, 144, 216,
(Continued)

(56) **References Cited**

U.S. PATENT DOCUMENTS

D552,249 S * 10/2007 Matsuura D24/216

D559,395 S * 1/2008 Matsuura D24/216

(Continued)

FOREIGN PATENT DOCUMENTS

WO WO-2016067333 A1 * 5/2016 A61B 10/0058

WO WO-2017046903 A1 * 3/2017 A61F 5/41

(Continued)

Primary Examiner — Richard E Chilcot

(74) *Attorney, Agent, or Firm* — Masuvalley & Partners

(57) **CLAIM**

The ornamental design for an ejaculation promotion apparatus, as shown and described.

DESCRIPTION

1. Ejaculation promotion apparatus

1.1 : Front

1.2 : Back

1.3 : Left

1.4 : Right

1.5 : Top

1.6 : Bottom

1.7 : Central longitudinal sectional view

1.8 : Perspective

1.9 : Front view with the cap separated from the ejaculation promotion apparatus;

1.10 : Top view of the cap of the ejaculation promotion apparatus;

1.11 : Cross sectional view of the ejaculation promotion apparatus;

1.12 : Front view of the cap and stand of the ejaculation promotion apparatus;

1.13 : Top view of the cap and stand of the ejaculation promotion apparatus;

1.14 : Cross sectional view of the cap and stand of the ejaculation promotion apparatus;

1.15 : Front view of the cap and central portion of the ejaculation promotion apparatus;

1.16 : Top view of the cap and central portion of the ejaculation promotion apparatus;

1.17 : Cross sectional view of the cap and stand of the ejaculation promotion apparatus; and

1.18 : Exploded perspective view of the ejaculation promotion apparatus.

1 Claim, 18 Drawing Sheets

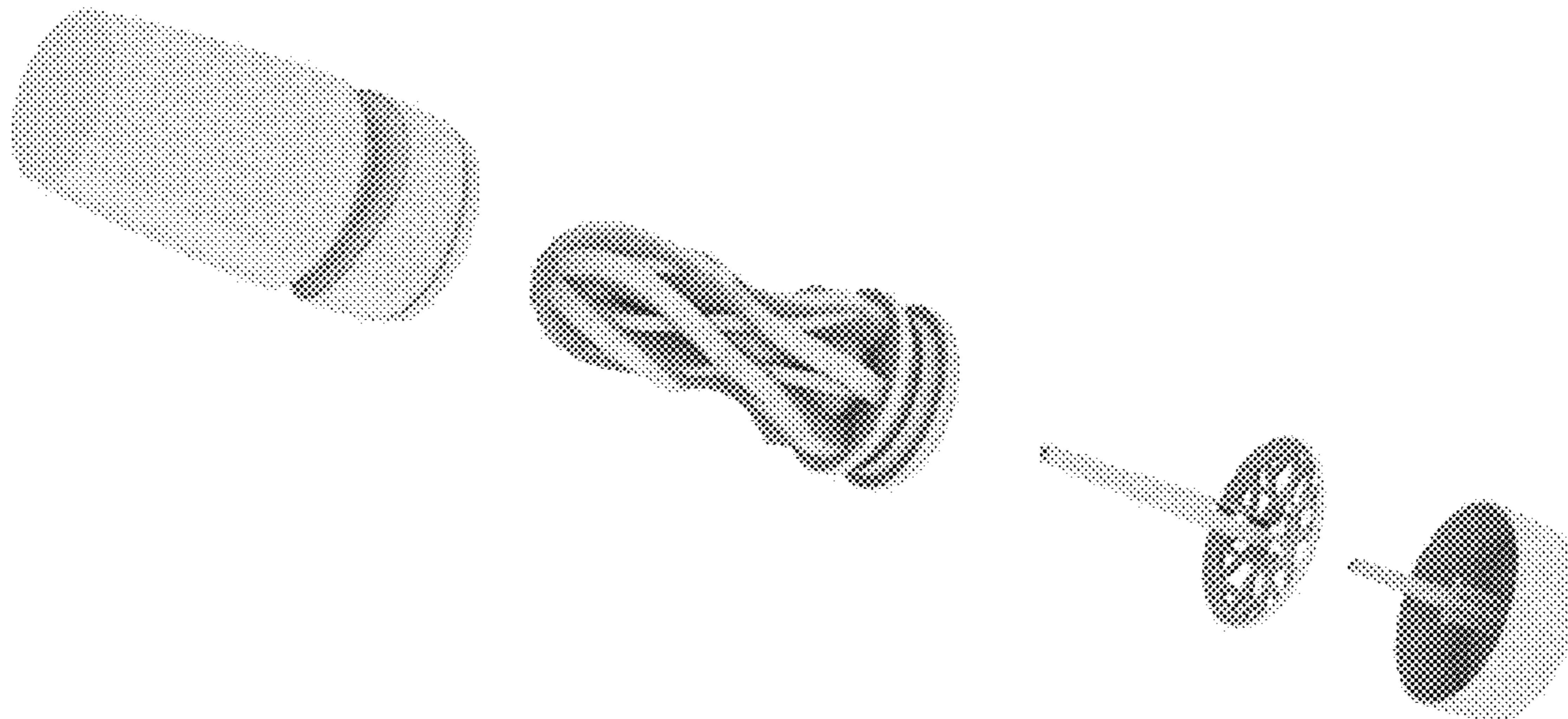

US D975,307 S

Page 2

(52) **U.S. Cl.**
CPC *A61F 5/41* (2013.01)

(58) **Field of Classification Search**
USPC D24/224, 193, 194, 195, 196, 197, 198,
D24/199, 207
CPC A61B 10/0058; A61F 5/451; A61F 5/453;
A61F 5/41; A61H 19/32; A61H
2201/1207; A61H 2201/1215; A61H
2201/1253; A61H 2201/1261; A61H
2201/1671; A61H 2201/5079; A61H
2205/087

See application file for complete search history.

(56) **References Cited**

U.S. PATENT DOCUMENTS

D560,282 S * 1/2008 Matsuura D24/216
D560,813 S * 1/2008 Matsuura D24/216
D580,067 S * 11/2008 Matsuura D24/216
D674,906 S * 1/2013 Matsuura D24/215
D675,331 S * 1/2013 Matsuura D24/215

D688,795 S * 8/2013 Matsuura D24/121
D695,414 S * 12/2013 Matsuura D24/215
D736,400 S * 8/2015 Matsuura D24/215
D736,401 S * 8/2015 Matsuura D24/215
D789,549 S * 6/2017 Matsuura D24/214
D823,462 S * 7/2018 Okamura D24/121
D843,592 S * 3/2019 Tsuyama D24/215
D886,318 S * 6/2020 Tsuyama D9/428
D888,980 S * 6/2020 Tsuyama D24/215
D890,947 S * 7/2020 Takahori D24/215
D898,215 S * 10/2020 Endo D24/215
D902,427 S * 11/2020 Okamura D24/215
D930,847 S * 9/2021 Endo D24/215
D950,097 S * 4/2022 Takahori D24/215
2020/0178943 A1 * 6/2020 Nakamura A61H 19/32
2021/0353269 A1 * 11/2021 Takahori A61B 10/0058
2021/0401409 A1 * 12/2021 Nakamura A61B 10/0058

FOREIGN PATENT DOCUMENTS

WO WO-2017068635 A1 * 4/2017
WO WO-2018025413 A1 * 2/2018 A61F 5/41

* cited by examiner

1.1

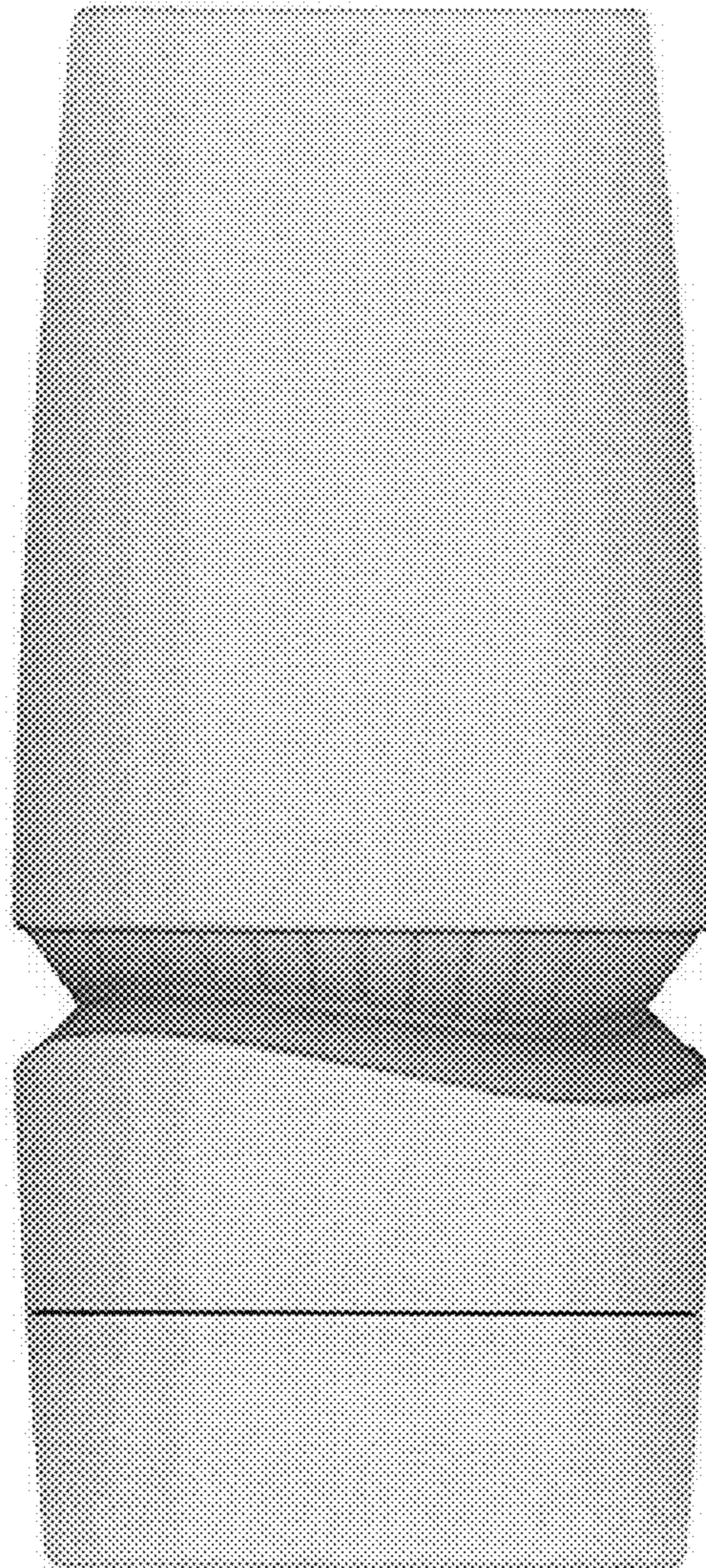

1.2

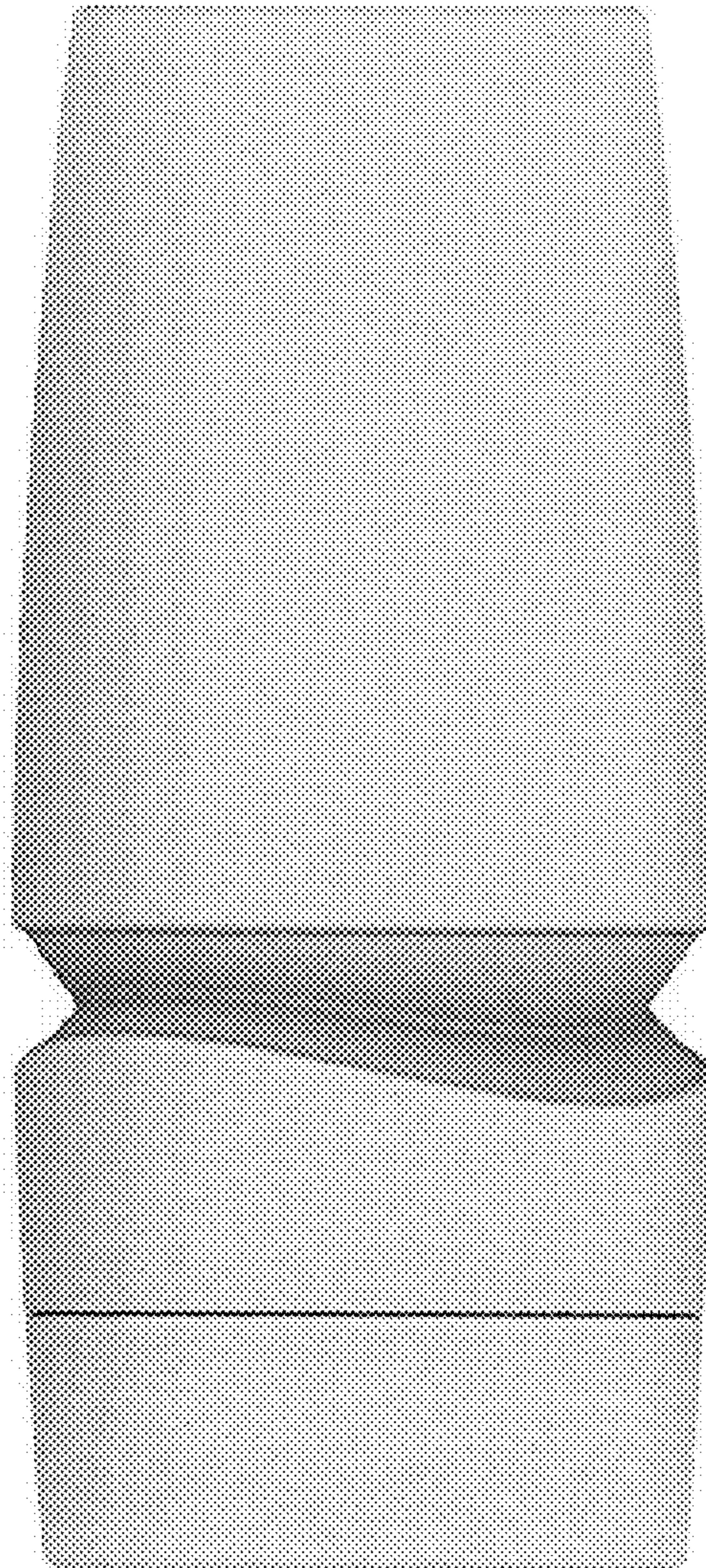

1.3



1.4



1.5

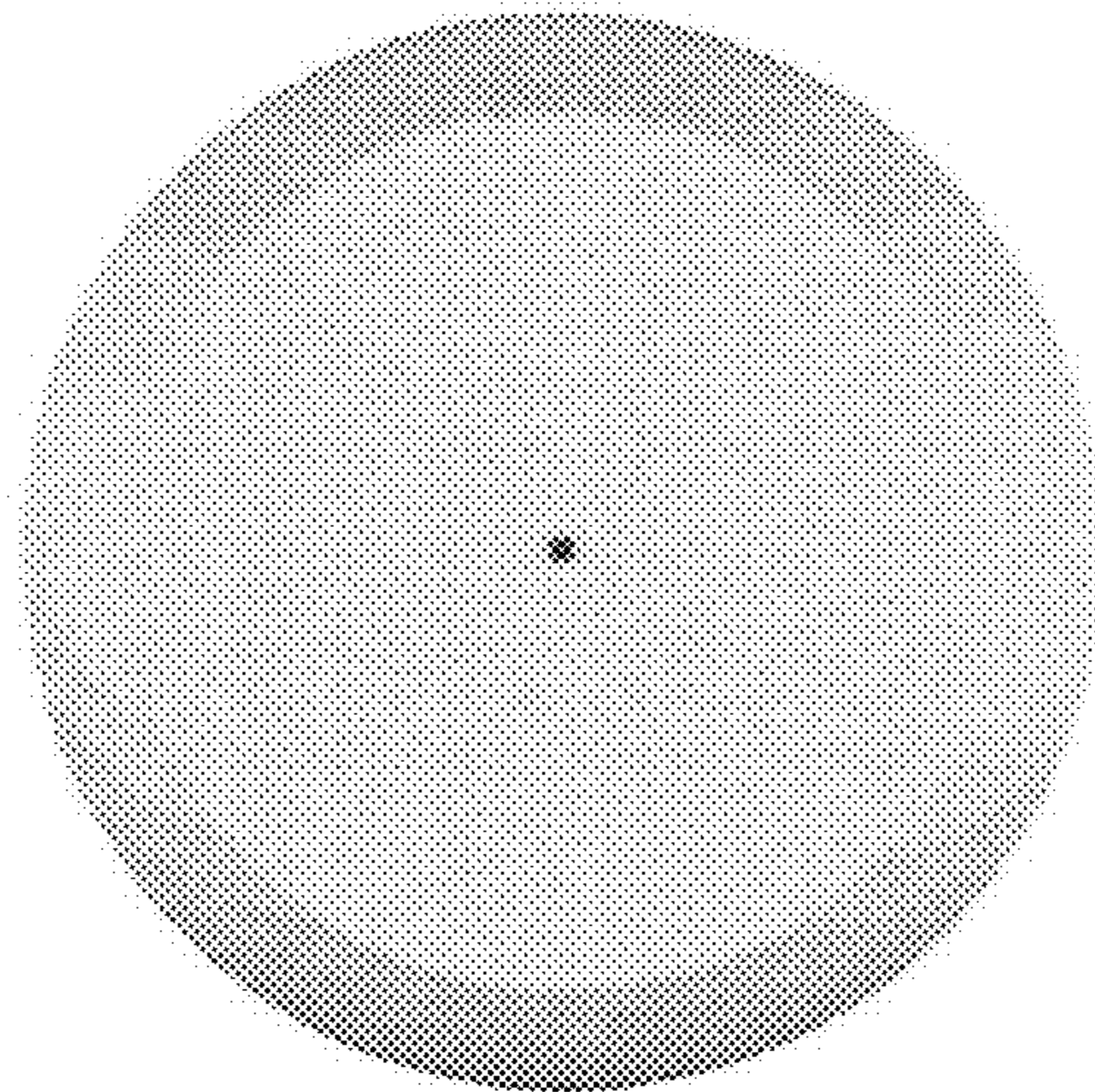

1.6

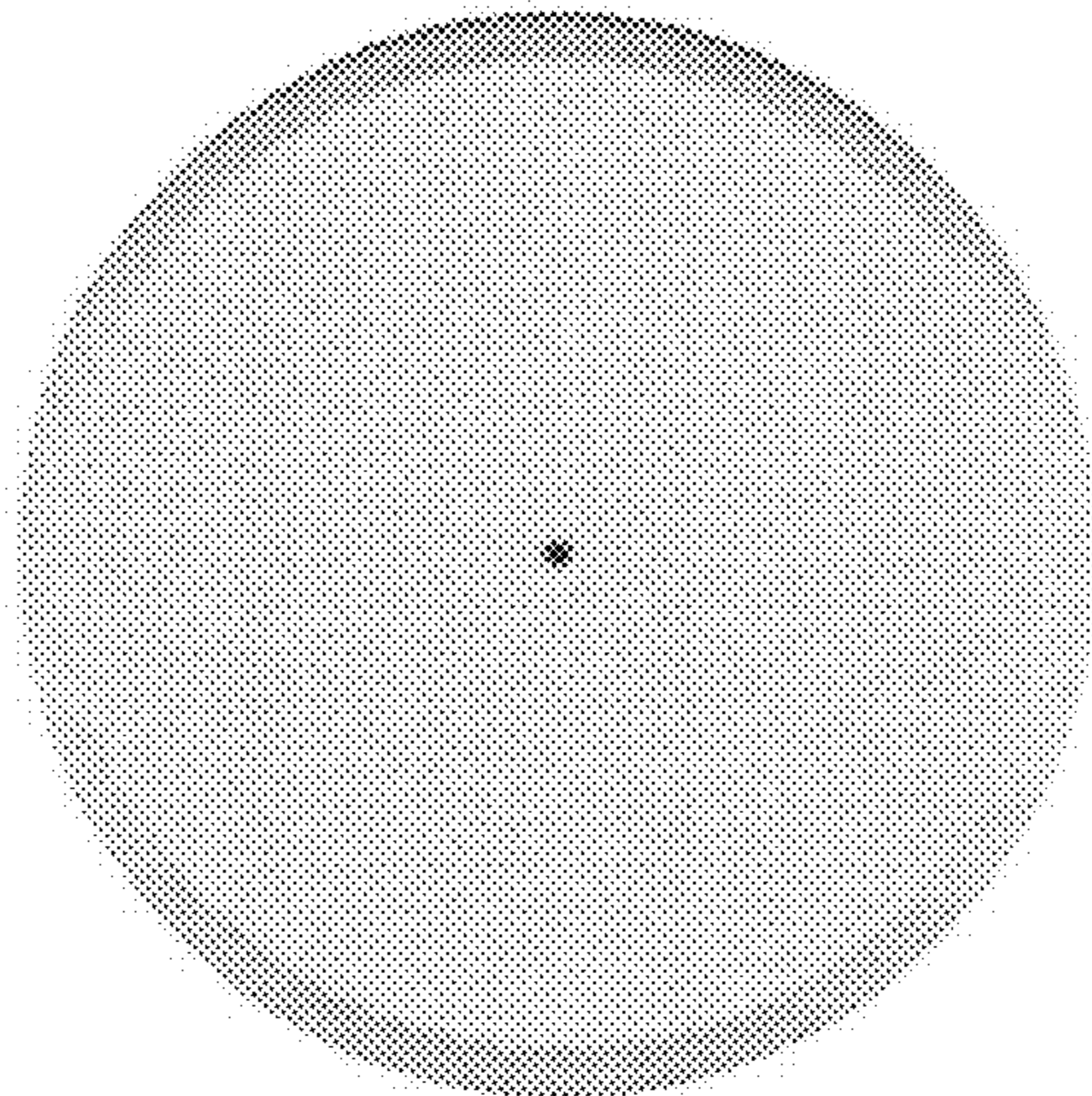

1.7

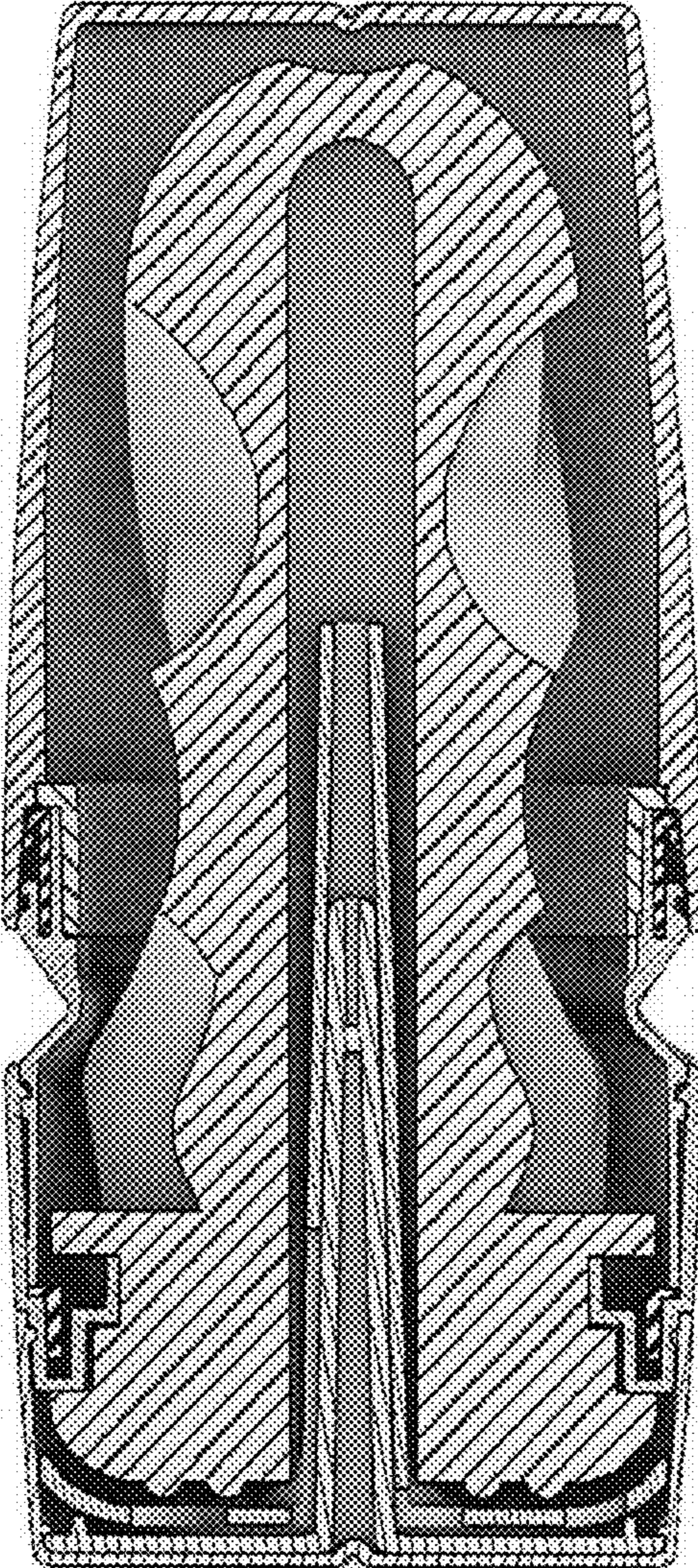

1.8

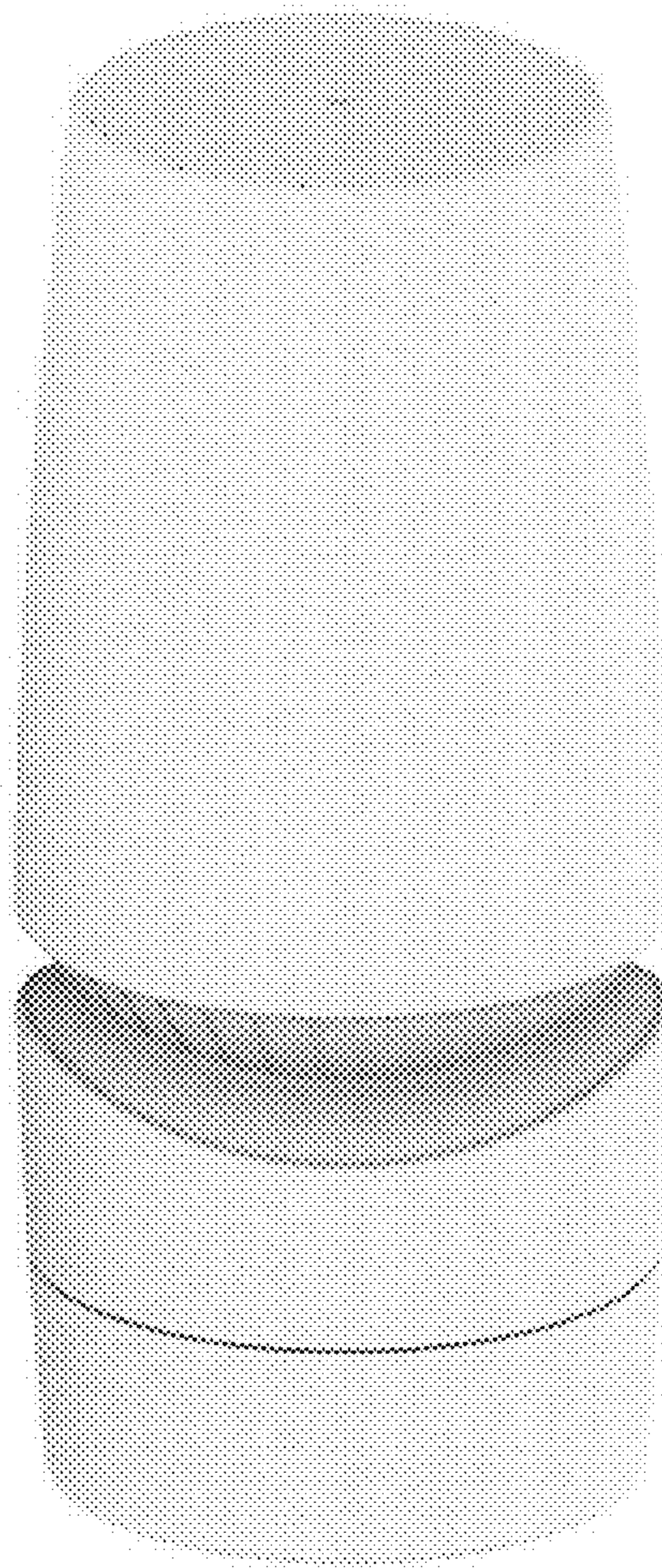

1.9

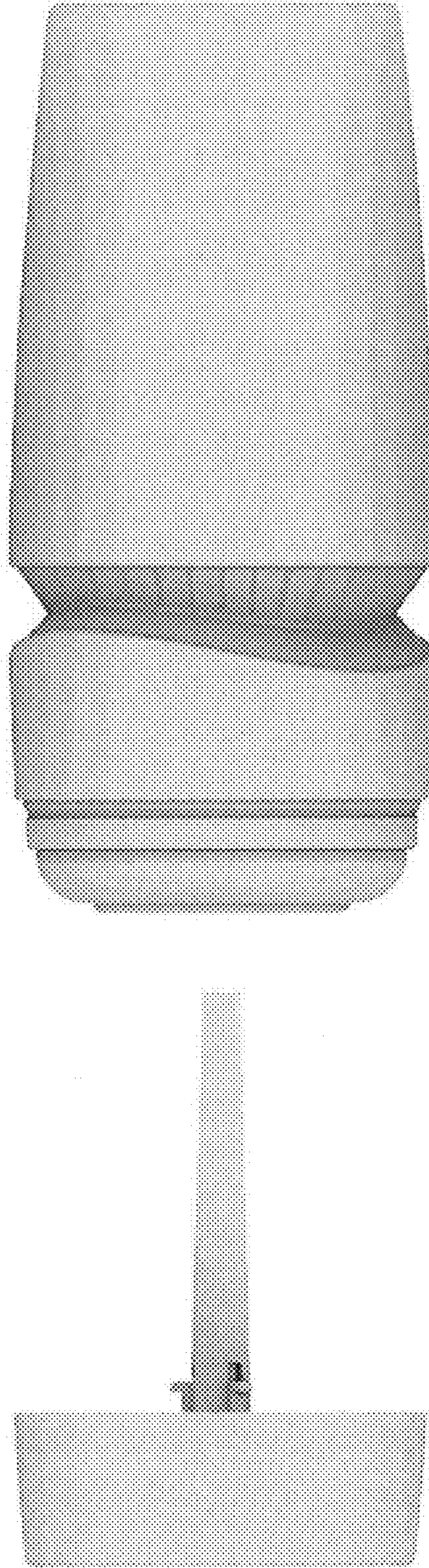

1.10

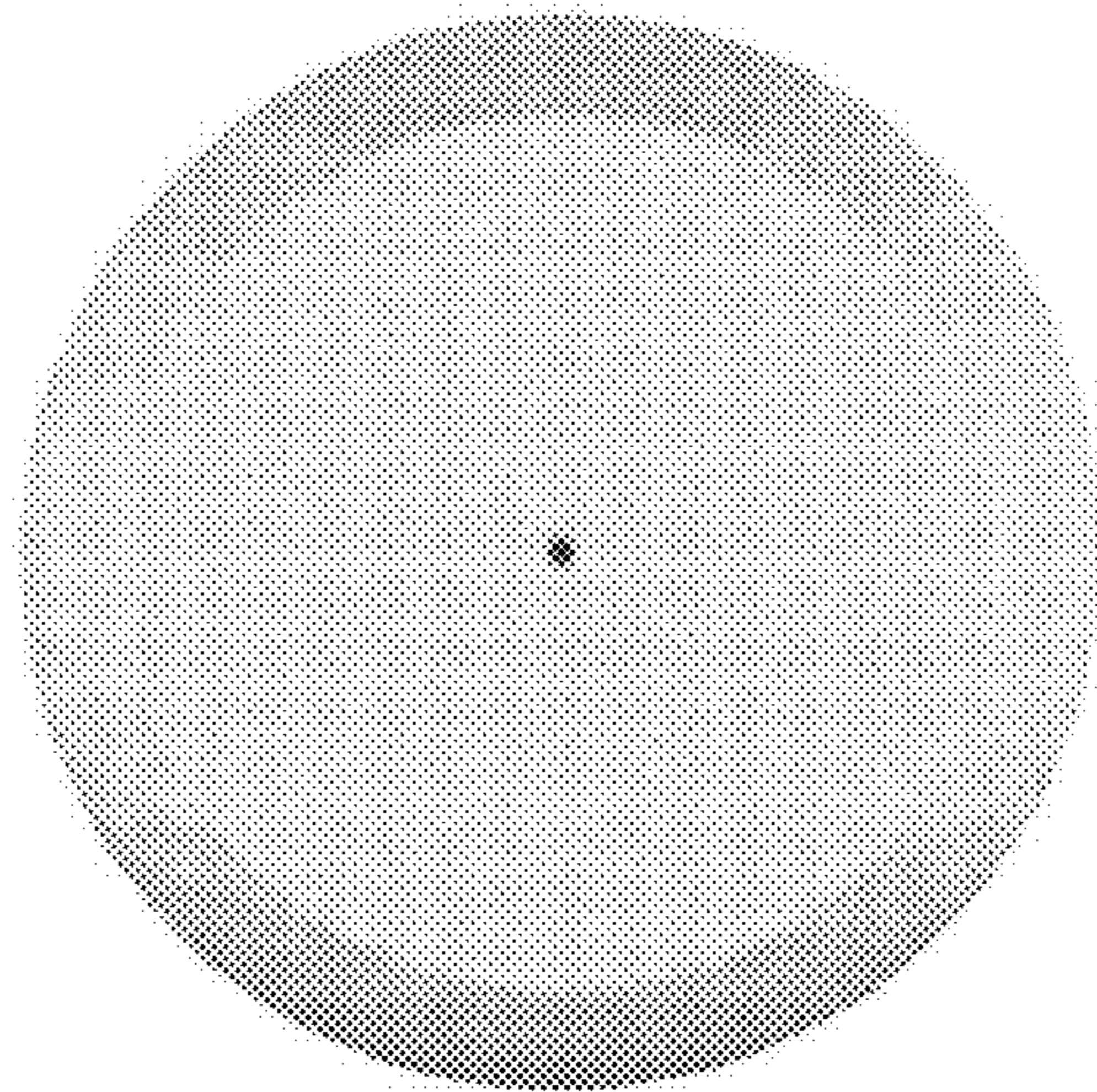

1.11

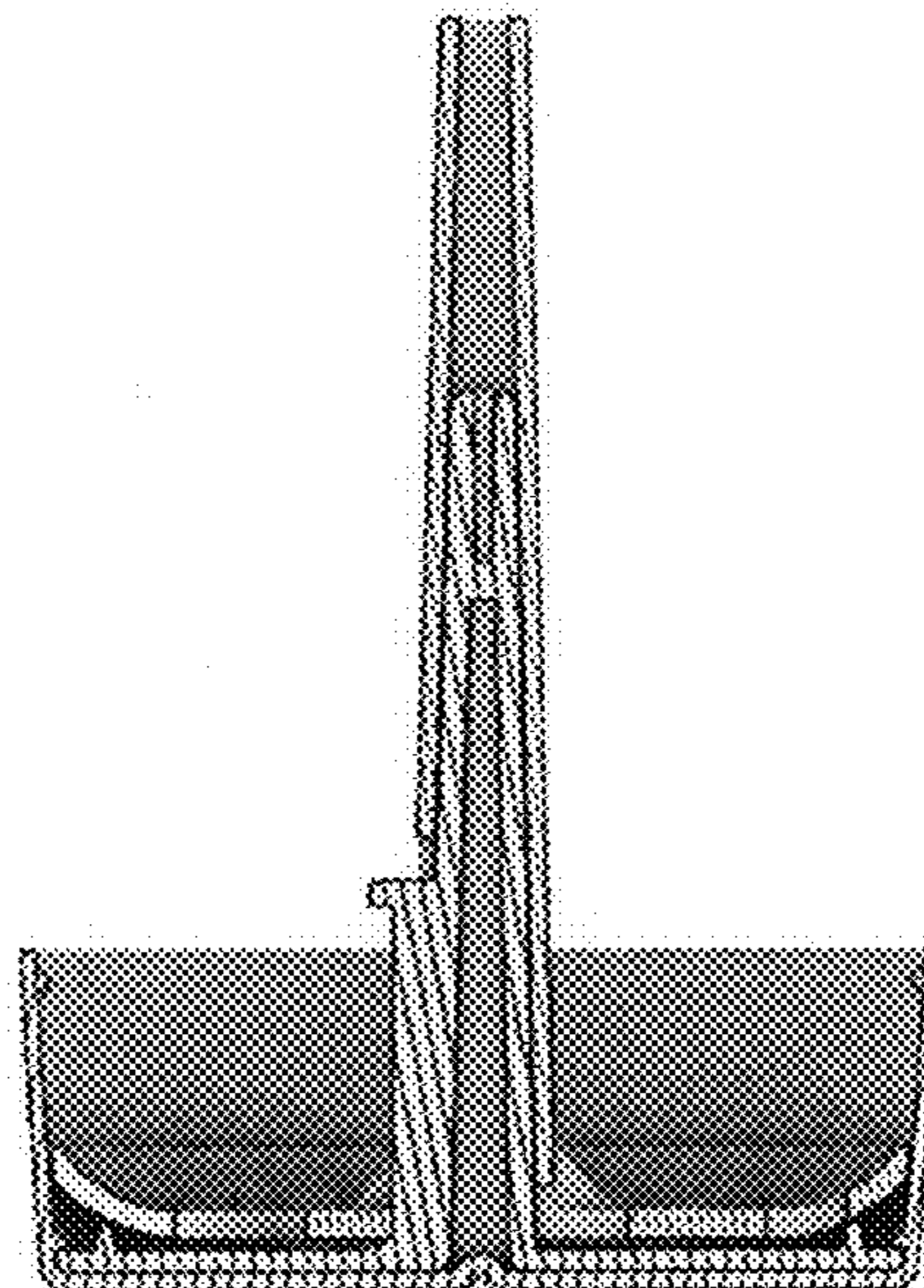
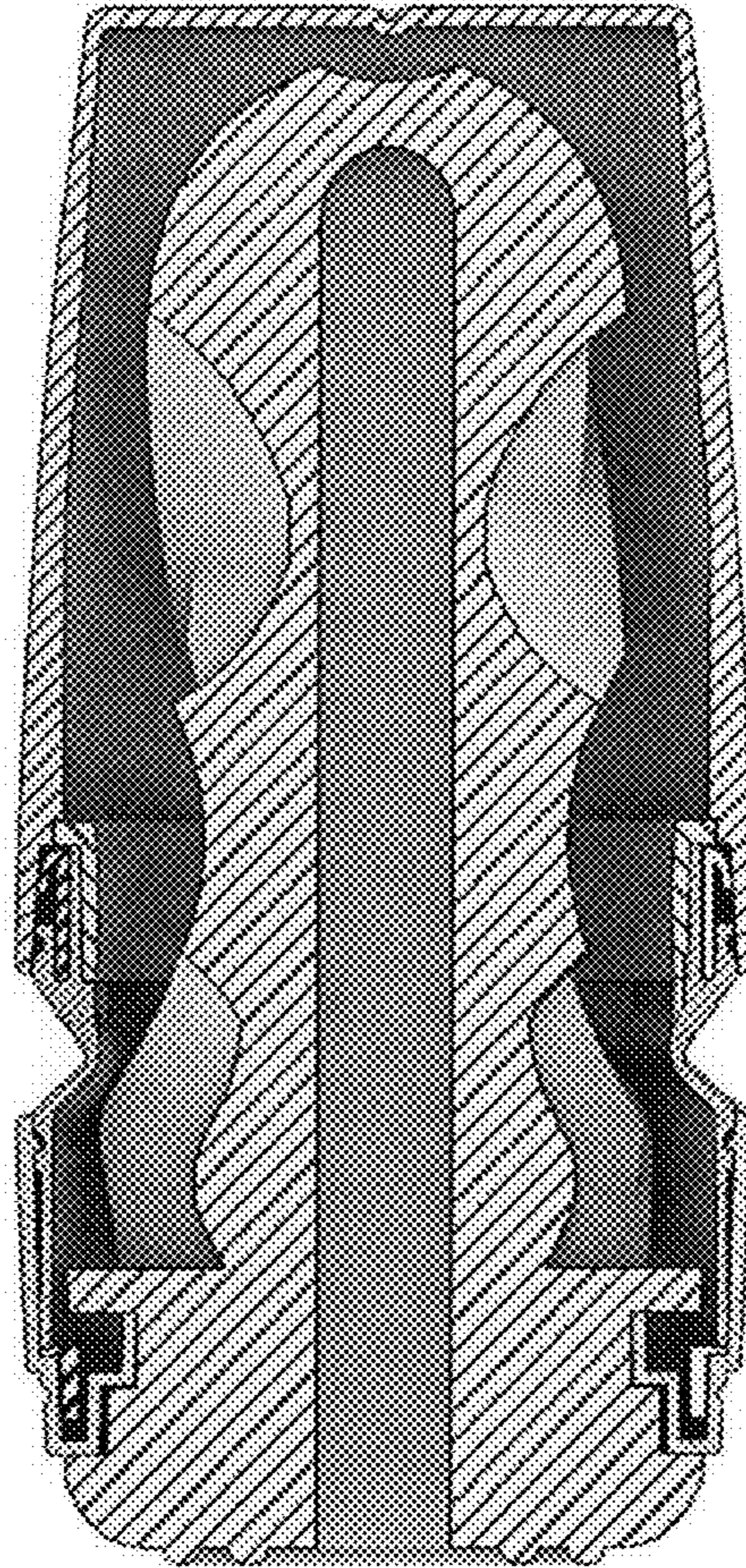

1.12

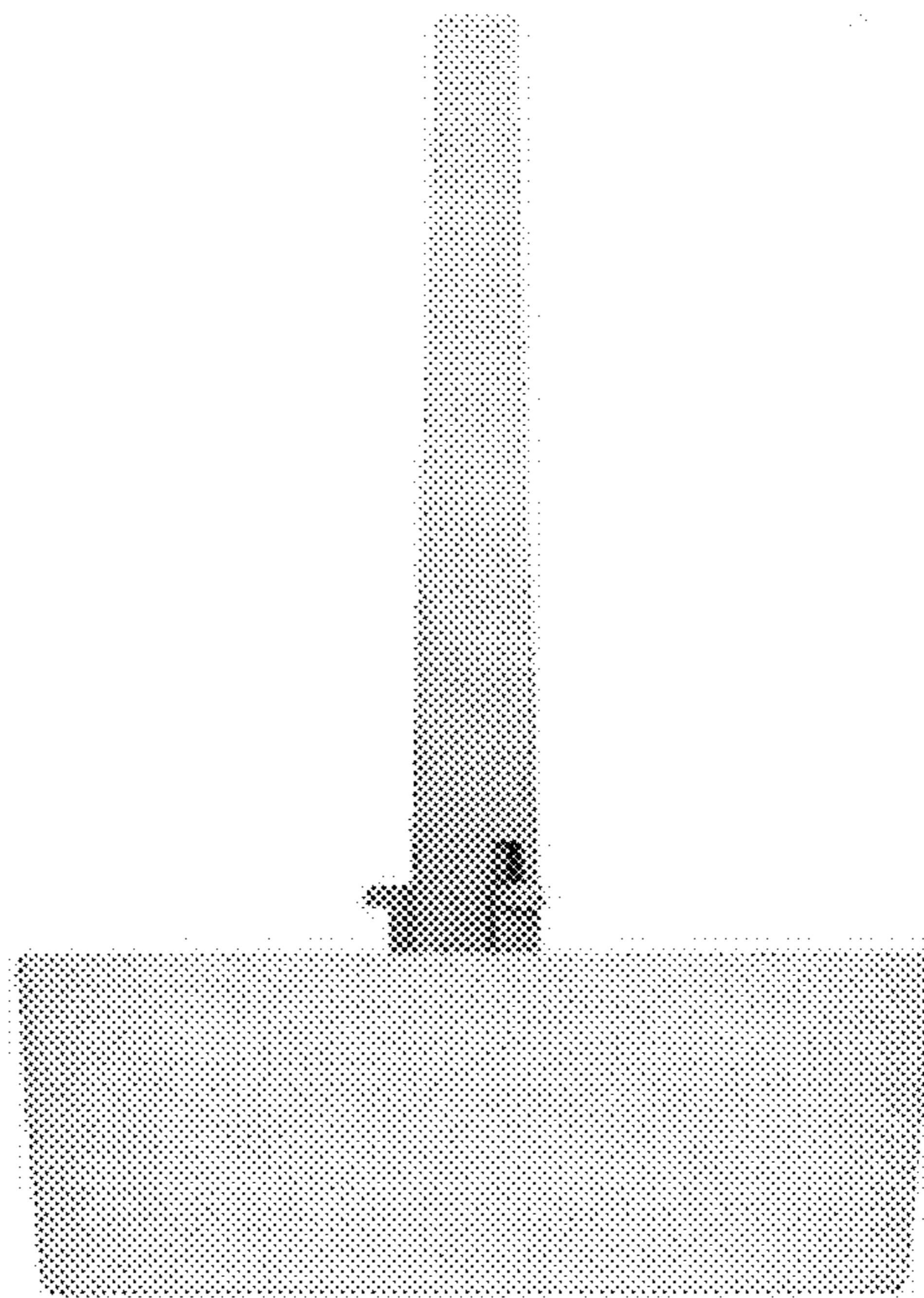

1.13

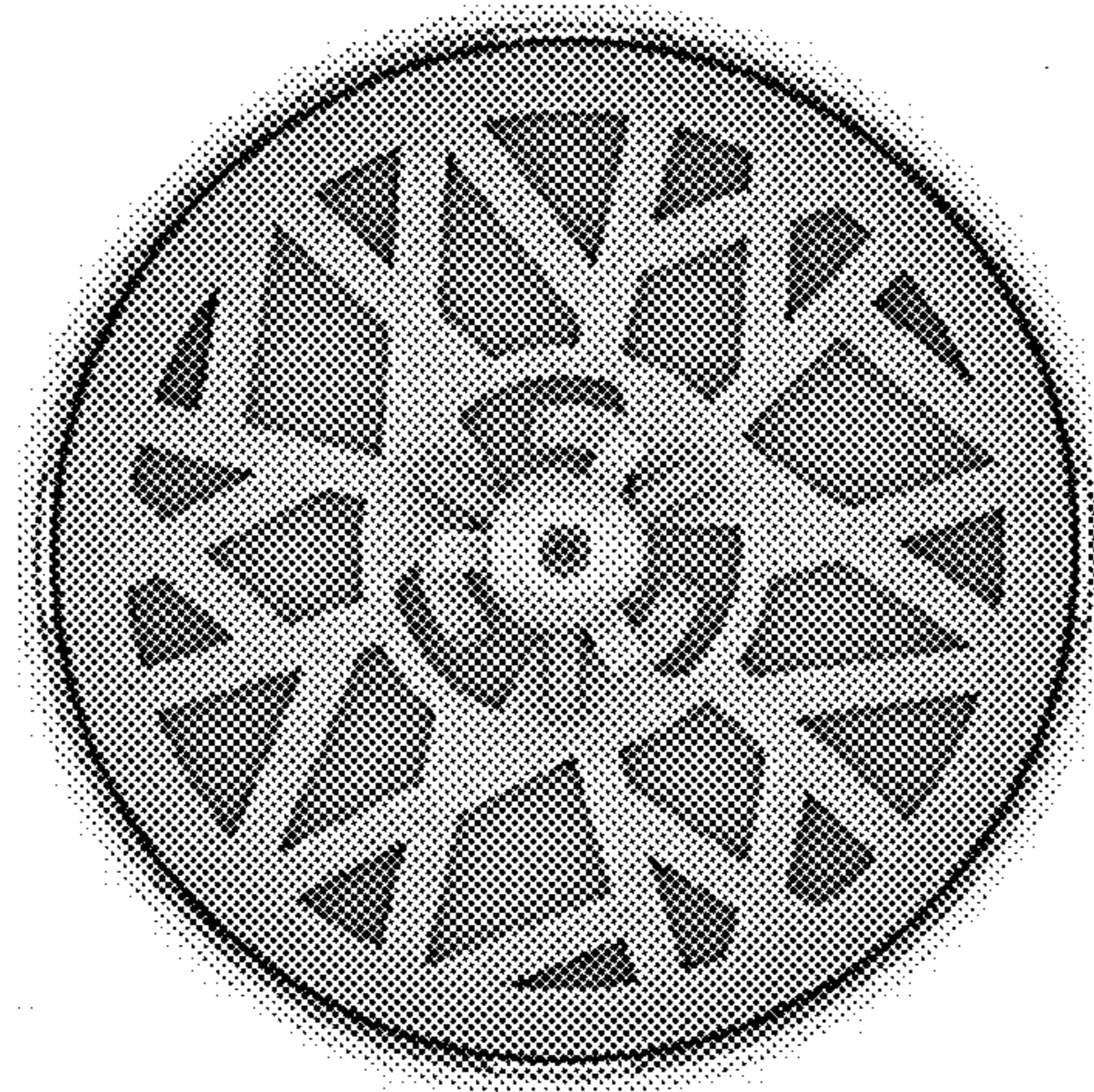

1.14

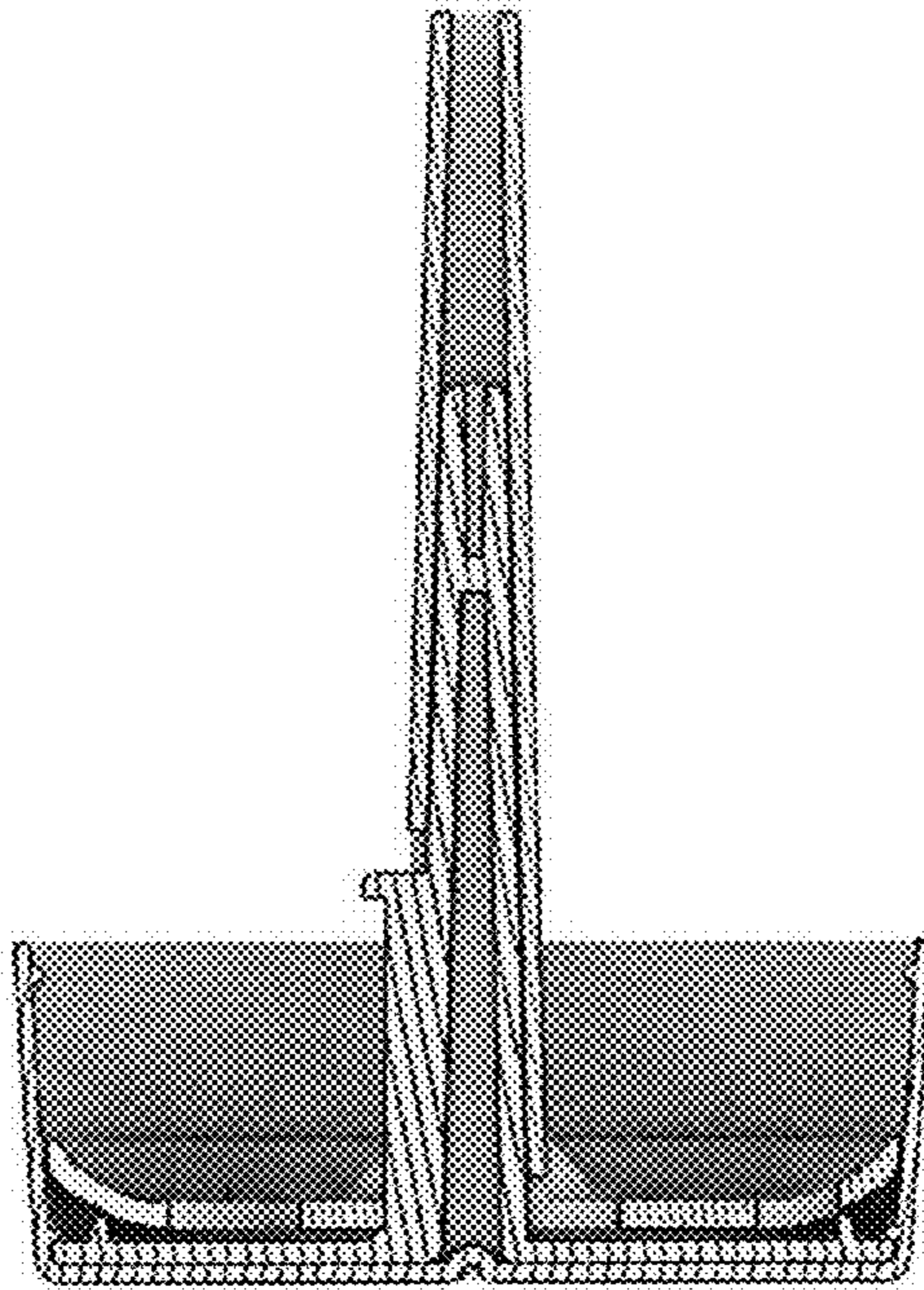

1.15

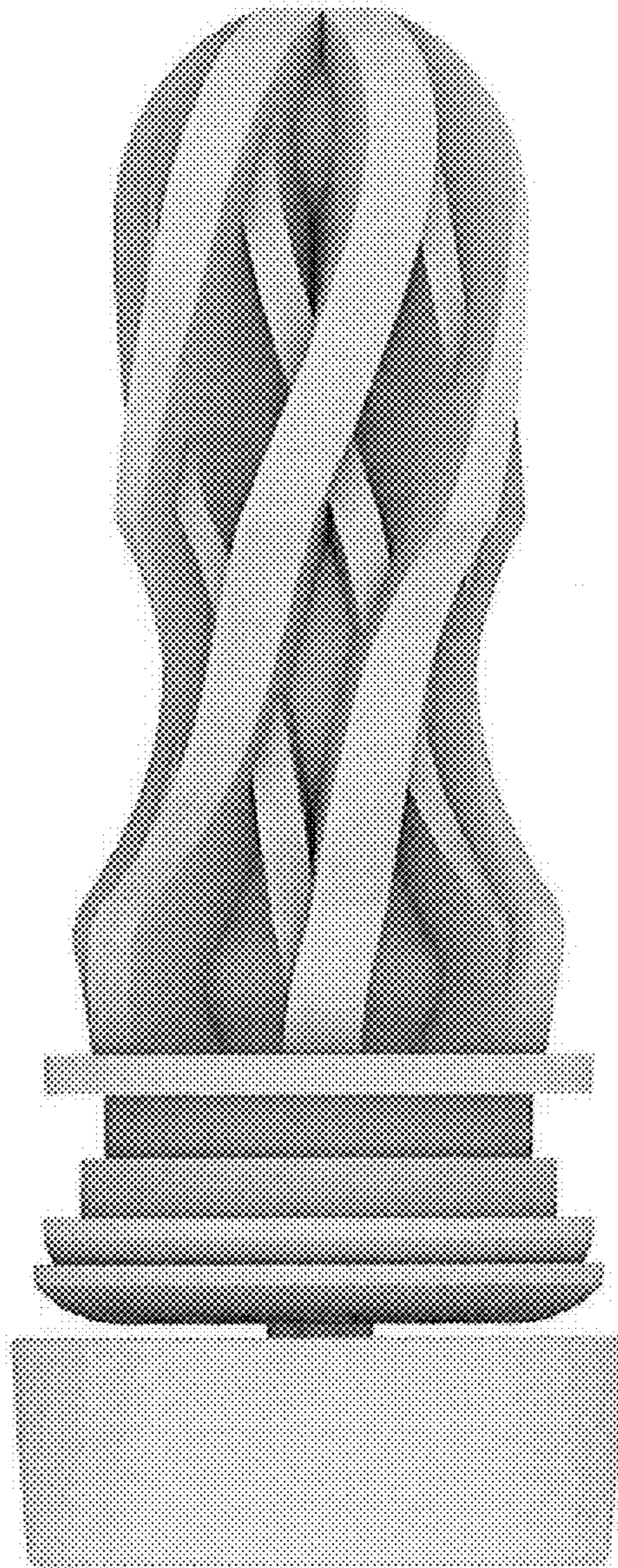

1.16

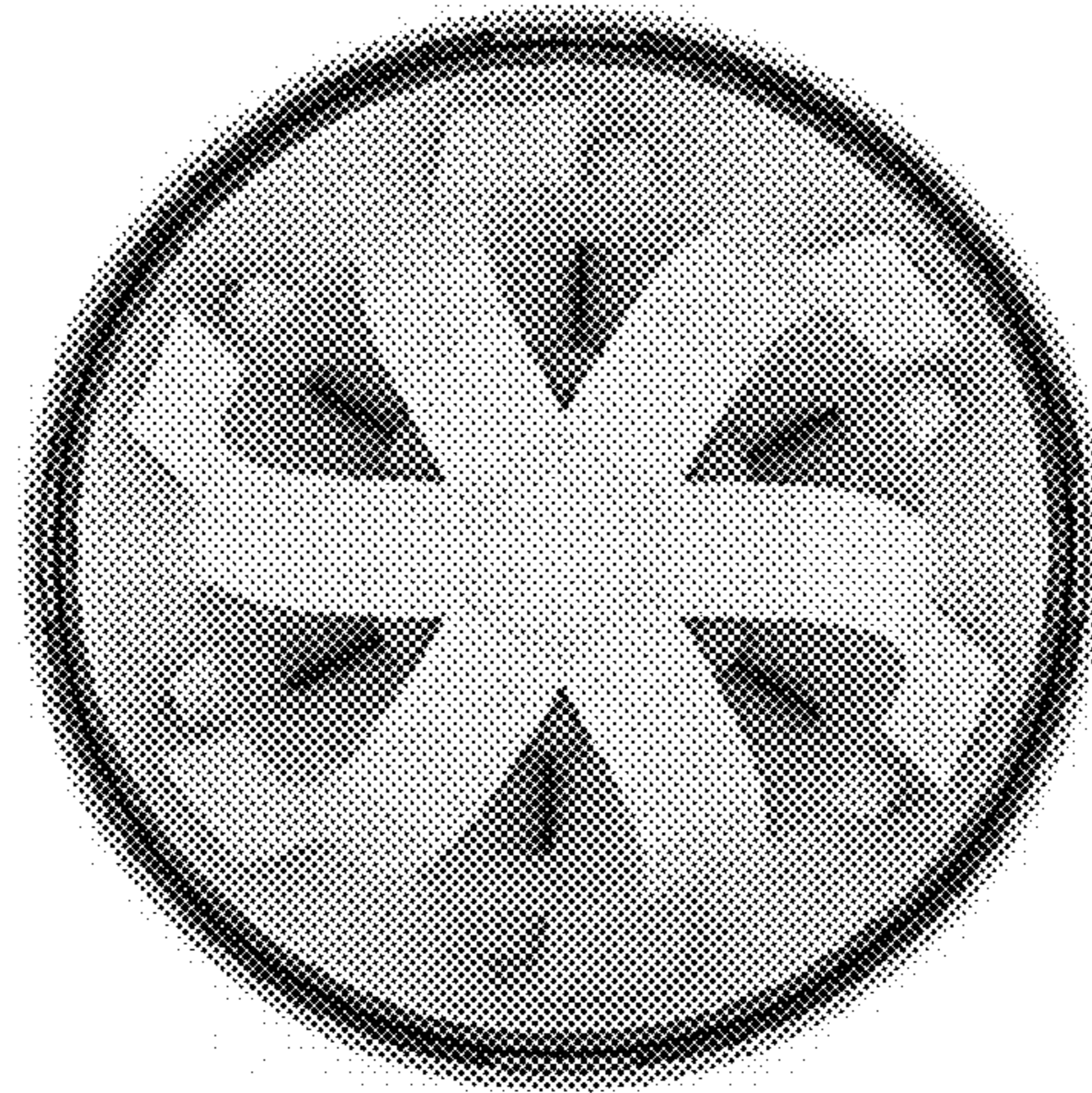

1.17

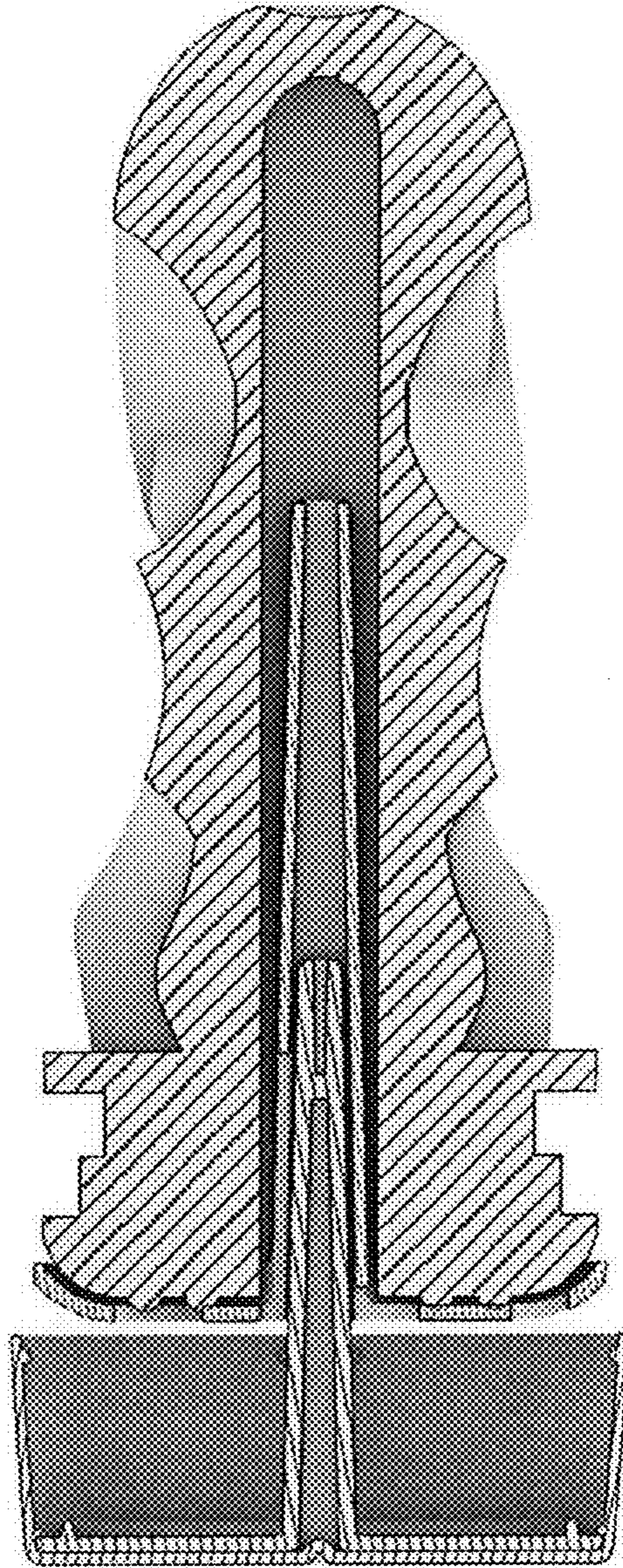

1.18

