



US00D975184S

(12) **United States Design Patent**
Valentine

(10) **Patent No.:** **US D975,184 S**
(45) **Date of Patent:** **** Jan. 10, 2023**

(54) **ROLLING WHEEL GAME**
(71) Applicant: **Katrina Valentine**, Warwickshire (GB)
(72) Inventor: **Katrina Valentine**, Warwickshire (GB)
(**) Term: **15 Years**
(21) Appl. No.: **29/851,255**
(22) Filed: **Aug. 26, 2022**

(51) **LOC (14) Cl.** **21-01**
(52) **U.S. Cl.**
USPC **D21/300**

(58) **Field of Classification Search**
USPC D21/300, 301, 302, 303, 304, 305, 309,
D21/310, 312, 313, 314, 315, 698, 699,
D21/701, 702, 703, 704, 705, 706, 707,
D21/708, 759, 781, 788, 789, 799.1, 800;
D25/38, 39, 50, 53, 100; D6/329, 332
CPC A63B 65/00; A63B 1/00; A63B 67/00;
A63B 63/00; A63B 63/04; A63B 63/045;
A63B 63/08; A63B 67/06; A63F 1/067;
A47B 25/00
See application file for complete search history.

(56) **References Cited**

U.S. PATENT DOCUMENTS

D77,683 S * 2/1929 Fritch D21/300
D244,873 S * 6/1977 Halapin D21/300
4,072,295 A * 2/1978 Roberts A63B 71/022
473/421
D250,283 S * 11/1978 Norton D21/699
D271,116 S * 10/1983 Burke D21/310
4,646,807 A * 3/1987 Doublet E01F 13/022
160/351
4,905,996 A * 3/1990 Tallent A63B 63/00
473/197
D358,849 S * 5/1995 McClellan D21/300
D375,325 S * 11/1996 McClellan D21/396
D384,109 S * 9/1997 Sirotic D21/300
D385,967 S * 11/1997 Junell D25/38.1

D391,996 S * 3/1998 McClellan D21/300
5,820,110 A * 10/1998 Beu E04H 3/123
52/9
D524,379 S * 7/2006 Law D21/302
D532,840 S * 11/2006 Krlin D21/698
D578,166 S * 10/2008 Wiroll D21/302
D646,334 S * 10/2011 Ingram D21/303
D656,995 S * 4/2012 Otey D21/337
D690,368 S * 9/2013 Wojdyla-Gray et al.
D703,774 S * 4/2014 Riccardella D21/699
D731,013 S * 6/2015 Jackowiak D21/699

(Continued)

Primary Examiner — Mehri F Bajoul

(57) **CLAIM**

The ornamental design for a rolling wheel game, as shown and described.

DESCRIPTION

FIG. 1 is a front and top perspective view of a rolling wheel game, showing my new design;
FIG. 2 is a rear and bottom perspective view thereof;
FIG. 3 is a front elevation view thereof;
FIG. 4 is a rear elevation view thereof;
FIG. 5 is a left side elevation view thereof;
FIG. 6 is a right side elevation view thereof;
FIG. 7 is a top plan view thereof;
FIG. 8 is a bottom plan view thereof;
FIG. 9 is a perspective view of an enlarged portion as designated in FIG. 2; and,
FIG. 10 is another perspective view of FIG. 1 thereof, showing the claimed design in a using position.
The long short broken lines in FIGS. 2 and 9 illustrate the bounds of the enlarged portion and form no part of the claimed design. The broken lines showing of a wheel, in FIG. 10, depict environmental structure that form no part of the claimed design. The remaining broken lines in the drawings depict portions of the rolling wheel game that form no part of the claimed design.

1 Claim, 10 Drawing Sheets

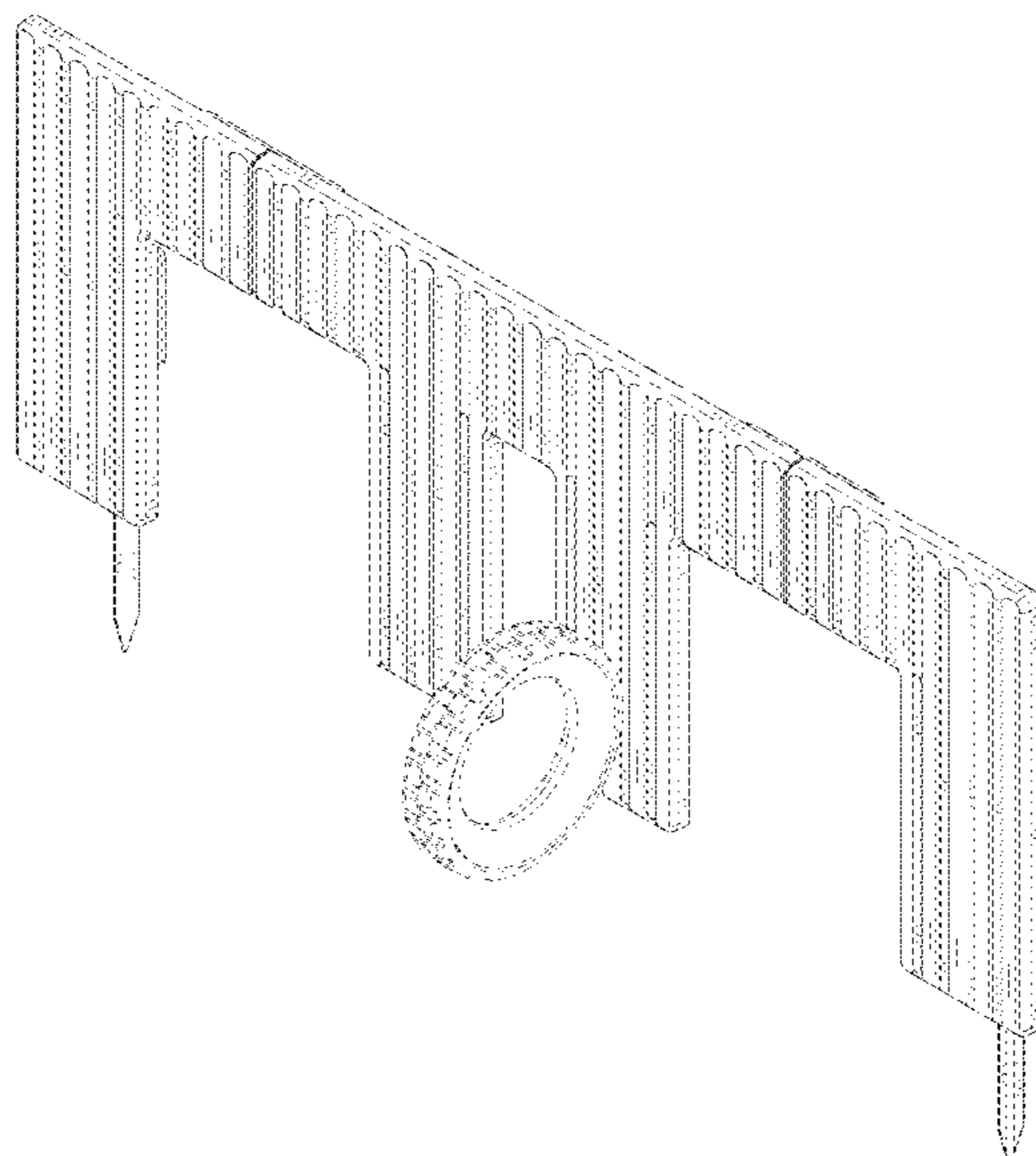

(56)

References Cited

U.S. PATENT DOCUMENTS

D761,622 S * 7/2016 Kushner D21/300
D786,380 S * 5/2017 Chang D21/800
D817,429 S * 5/2018 Adkisson D21/698
D870,317 S * 12/2019 King D25/48.5

* cited by examiner

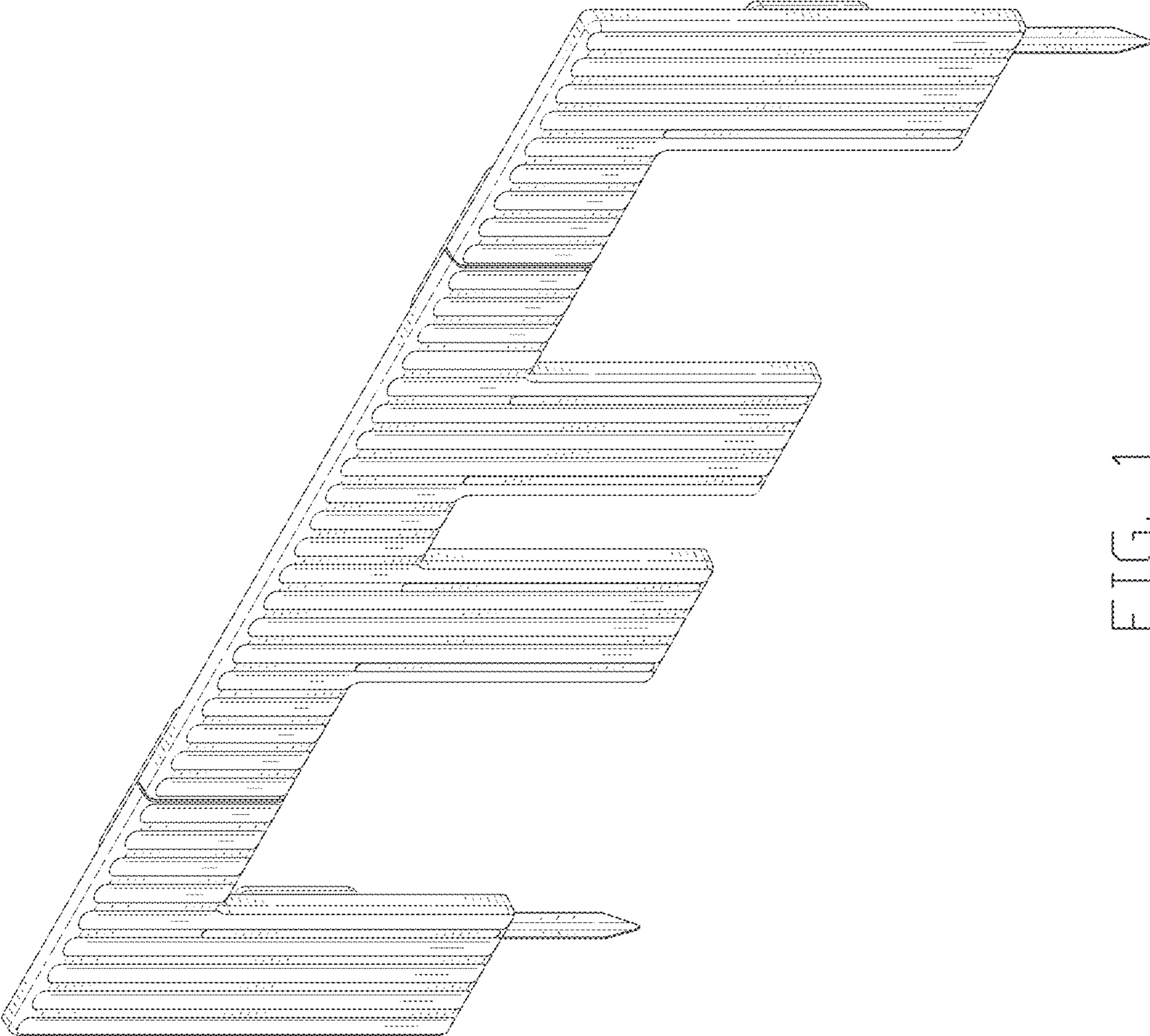

FIG. 1

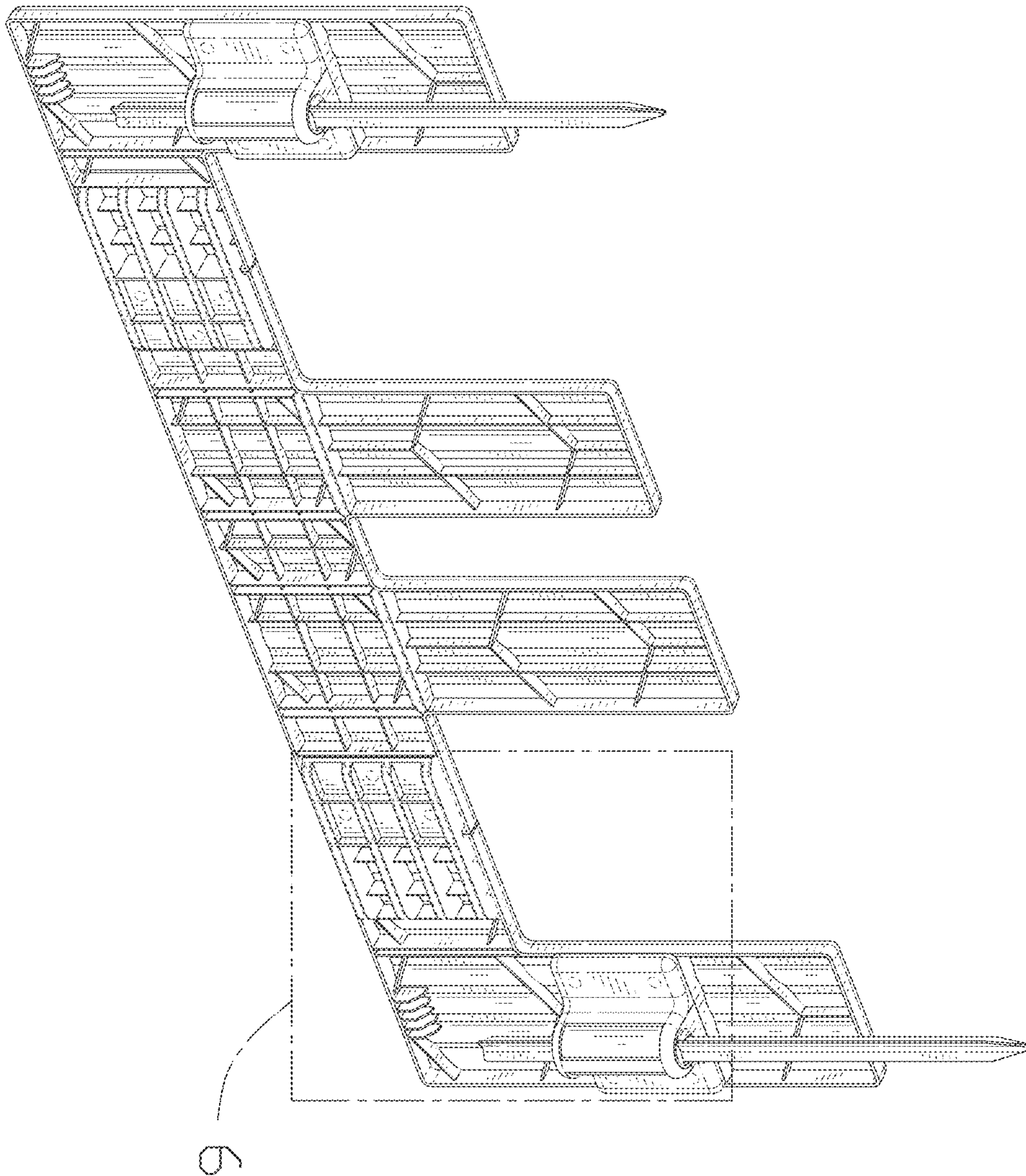

FIG. 2

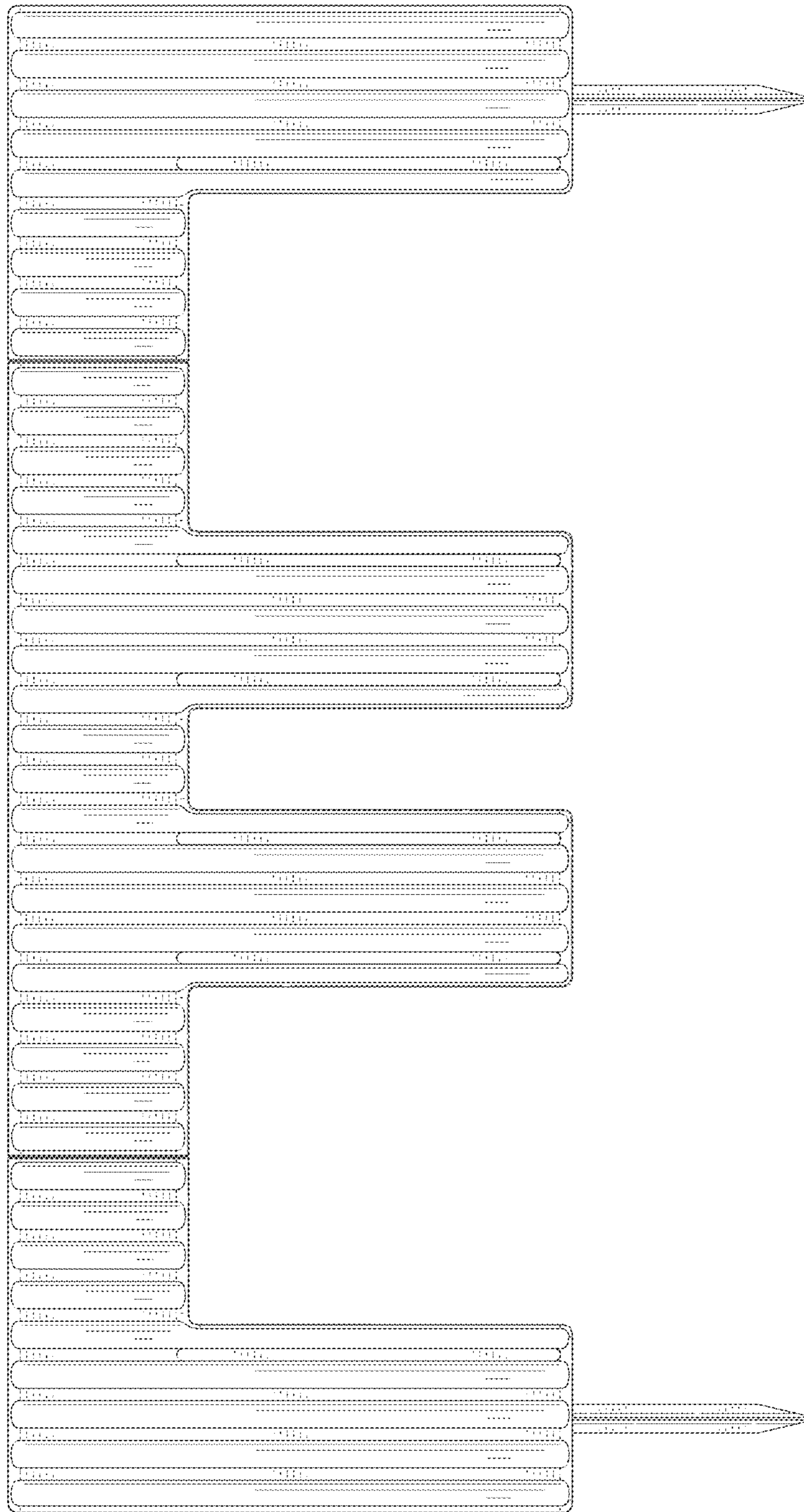

FIG. 3

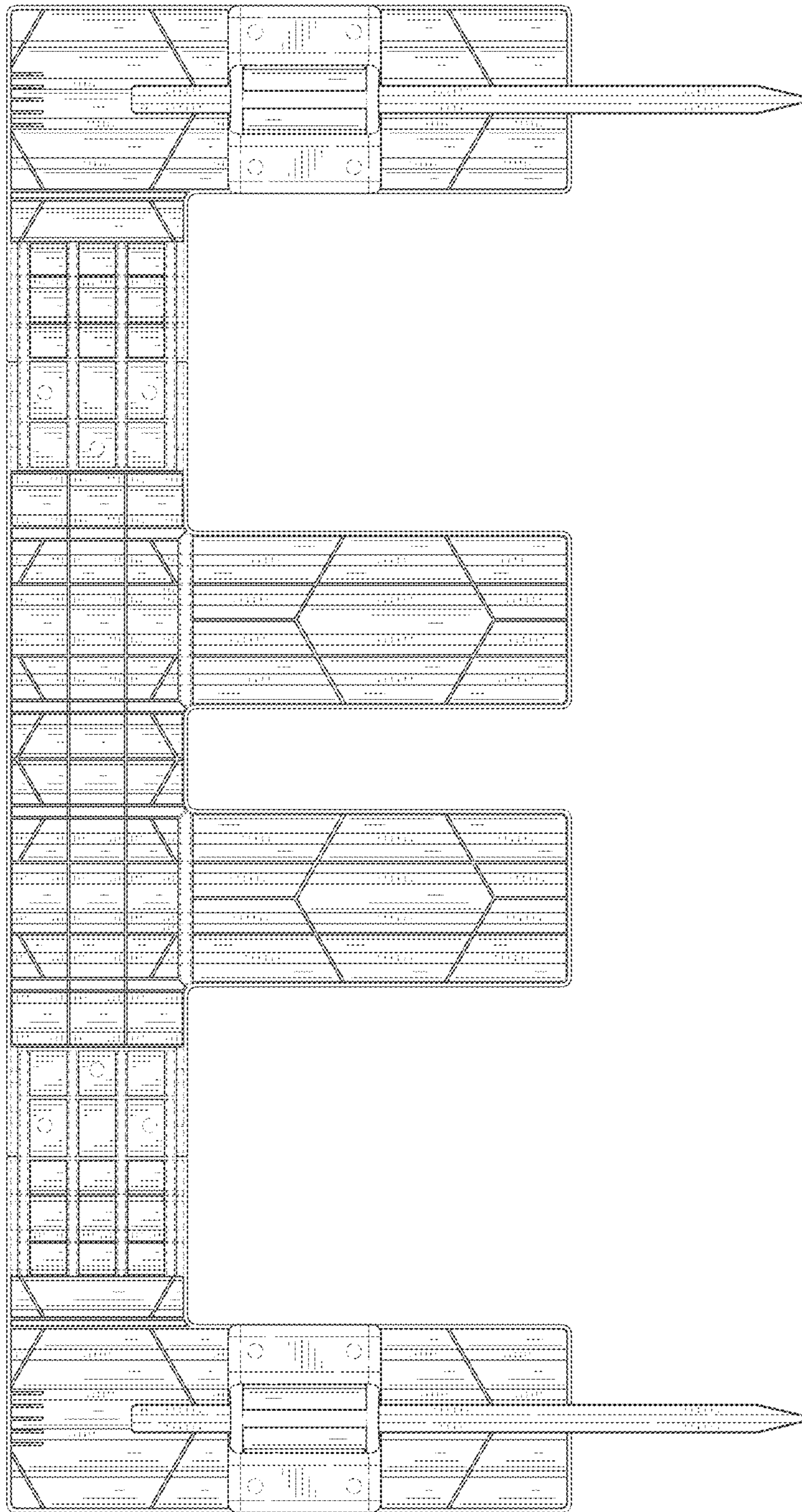

FIG. 4

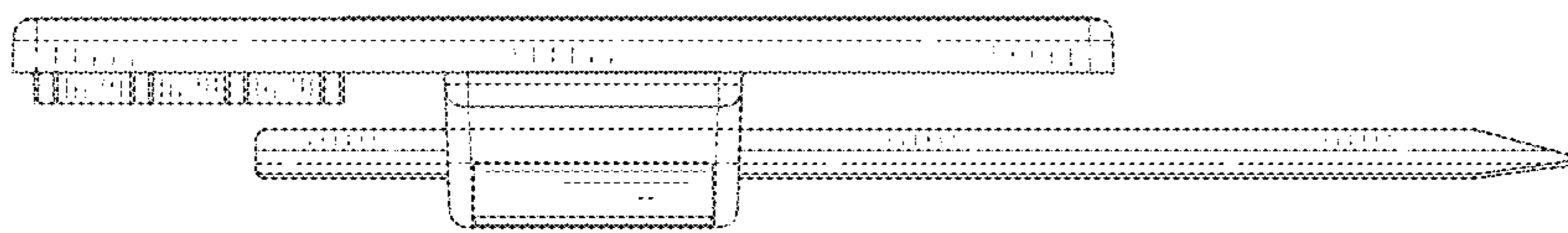

FIG. 5

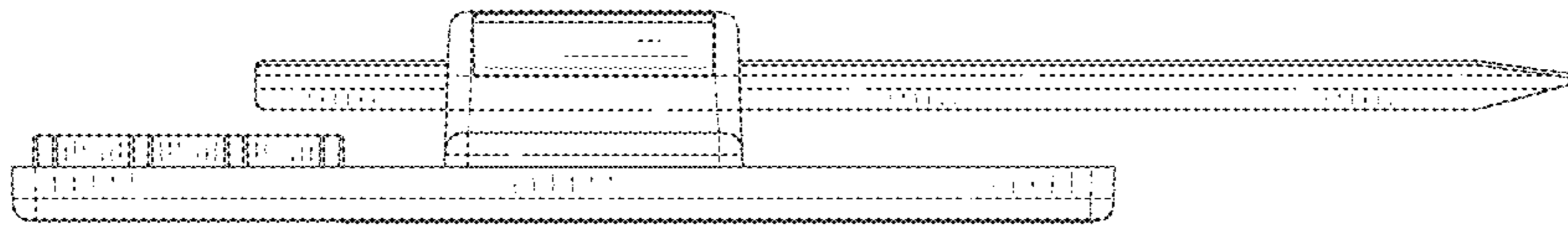

FIG. 6

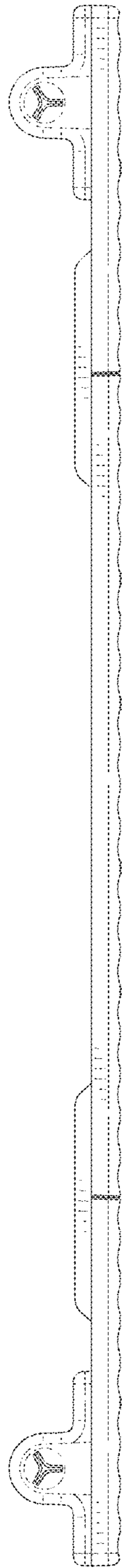

FIG. 7

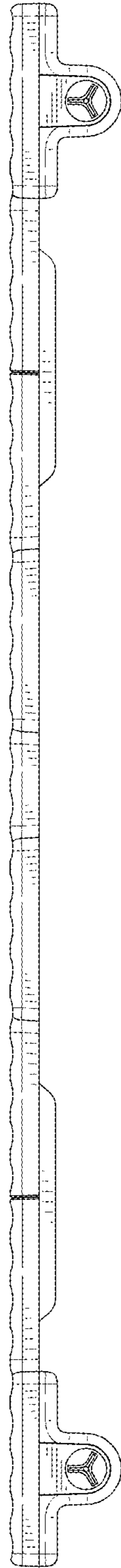

FIG. 8

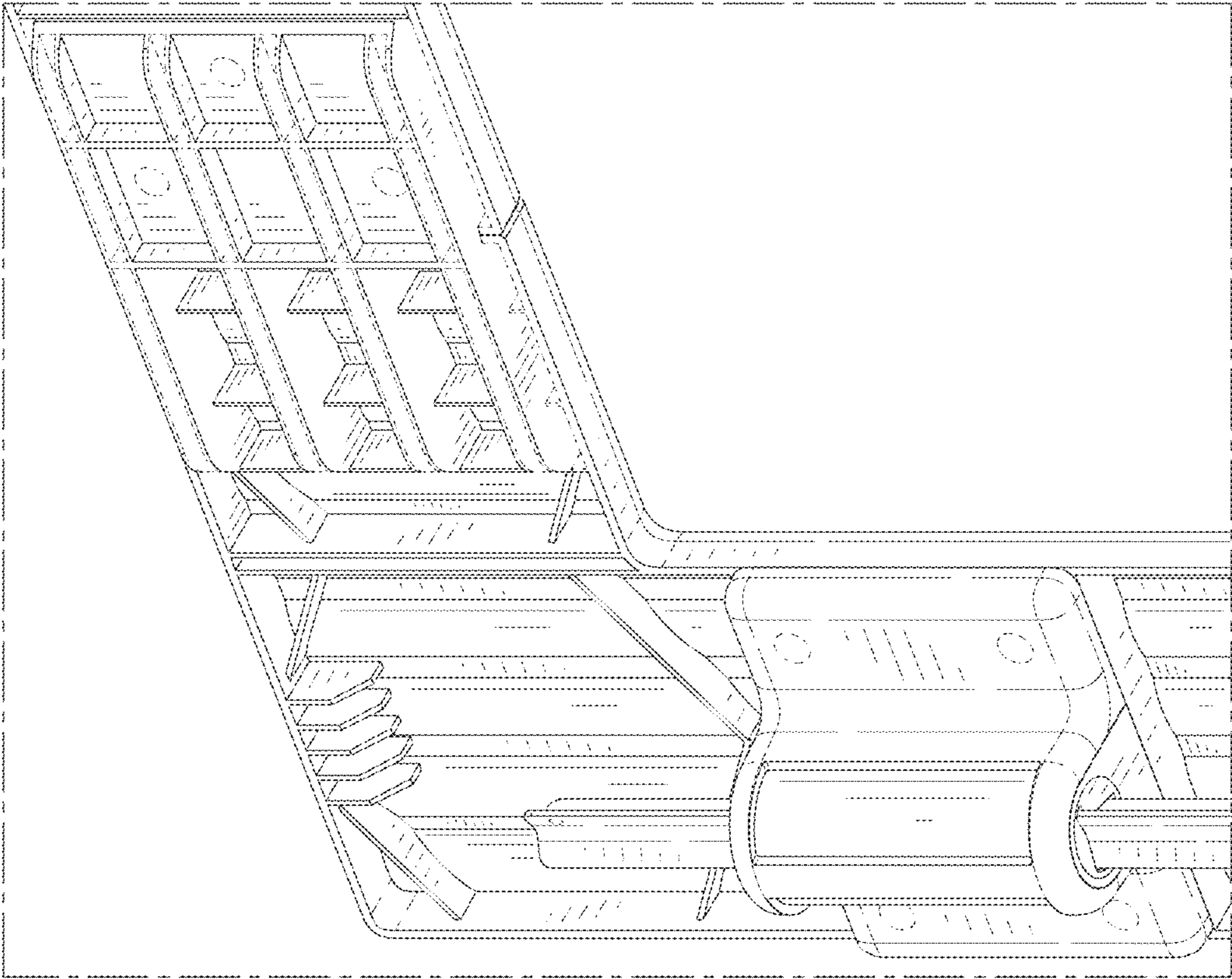

FIG. 9

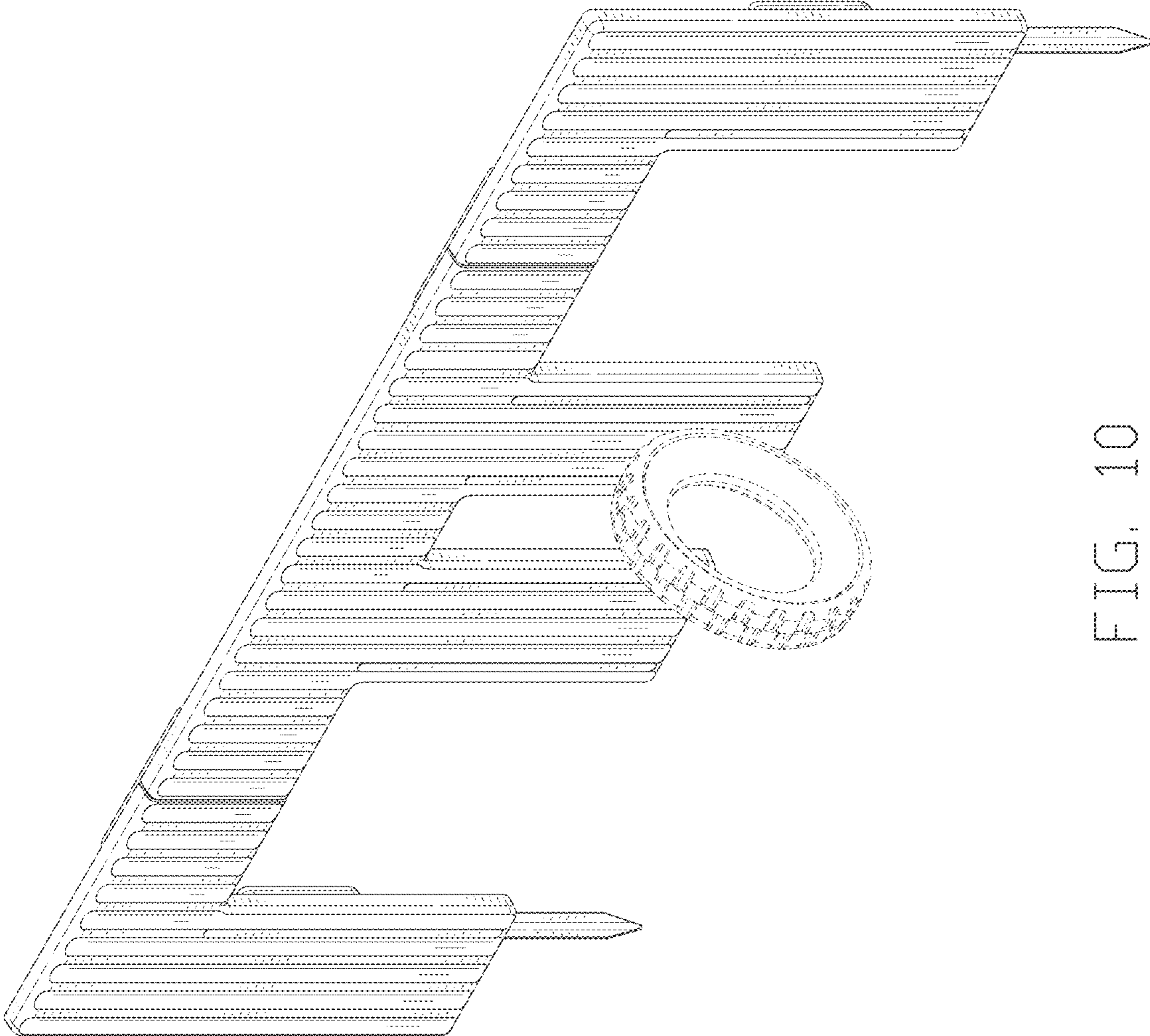

FIG. 10