



US00D975066S

(12) **United States Design Patent**
Akana et al.

(10) **Patent No.:** **US D975,066 S**
(45) **Date of Patent:** **** Jan. 10, 2023**

(54) **EARPHONE**

(71) Applicant: **Apple Inc.**, Cupertino, CA (US)

(72) Inventors: **Jody Akana**, San Francisco, CA (US); **Molly Anderson**, San Francisco, CA (US); **Bartley K. Andre**, Palo Alto, CA (US); **Shota Aoyagi**, San Francisco, CA (US); **Anthony Michael Ashcroft**, San Francisco, CA (US); **Marine C. Bataille**, San Francisco, CA (US); **Jeremy Bataillou**, San Francisco, CA (US); **Markus Diebel**, San Francisco, CA (US); **M. Evans Hankey**, San Francisco, CA (US); **Julian Hoenig**, San Francisco, CA (US); **Richard P. Howarth**, San Francisco, CA (US); **Jonathan P. Ive**, San Francisco, CA (US); **Julian Jaede**, San Francisco, CA (US); **Duncan Robert Kerr**, San Francisco, CA (US); **Peter Russell-Clarke**, San Francisco, CA (US); **Benjamin Andrew Shaffer**, San Jose, CA (US); **Sung-Ho Tan**, Vienna (AT); **Clement Tissandier**, San Francisco, CA (US); **Eugene Antony Whang**, San Francisco, CA (US); **Rico Zörkendörfer**, San Francisco, CA (US)

(73) Assignee: **Apple Inc.**, Cupertino, CA (US)

(**) Term: **15 Years**

(21) Appl. No.: **29/837,465**

(22) Filed: **May 5, 2022**

Related U.S. Application Data

(63) Continuation of application No. 29/805,722, filed on Aug. 30, 2021, now Pat. No. Des. 951,234, which is a continuation of application No. 29/768,810, filed on Feb. 1, 2021, now Pat. No. Des. 929,376, and a continuation of application No. 29/768,818, filed on Feb. 1, 2021, now Pat. No. Des. 929,972, and a

continuation of application No. 29/706,556, filed on Sep. 20, 2019, now Pat. No. Des. 909,347, which is a continuation of application No. 29/706,556, filed on Sep. 20, 2019, now Pat. No. Des. 909,347.

(51) **LOC (14) Cl.** **14-01**

(52) **U.S. Cl.**
USPC **D14/223**

(58) **Field of Classification Search**
USPC D14/223, 205; D24/174; 128/864-866; 381/380-381
CPC H04R 1/10; H04R 25/00; H04R 25/02; H04R 1/1066; H04R 1/1016; H04R 5/033; H04R 5/0335; H04R 1/105; H04R 1/1091

See application file for complete search history.

(56) **References Cited**

U.S. PATENT DOCUMENTS

2,148,477 A	2/1939	Koch
2,595,489 A	5/1952	Rutter et al.
3,368,644 A	2/1968	Henderson
3,459,902 A	8/1969	Warning
3,588,384 A	6/1971	Negley et al.
3,781,492 A	12/1973	Cragg et al.
4,532,649 A	7/1985	Bellafiore
4,672,672 A	6/1987	Eggert et al.
4,677,675 A	6/1987	Killion et al.
4,736,430 A	4/1988	Schroeder
4,742,887 A	5/1988	Yamagishi et al.
D296,435 S	6/1988	Kubota
4,889,303 A	12/1989	Wolf et al.
4,893,344 A	1/1990	Traegardh et al.
4,965,838 A	10/1990	Kamon et al.
4,972,492 A	11/1990	Tanaka et al.
D316,550 S	4/1991	Sogabe
D331,057 S	11/1992	Isonaga
D331,061 S	11/1992	Hyohgo
D337,118 S	7/1993	Seikita
D337,589 S	7/1993	Wada
D344,800 S	3/1994	Lamby
D353,379 S	12/1994	Nakamura et al.
5,420,935 A	5/1995	Shinohara et al.
D410,079 S	5/1999	Falco et al.
6,122,369 A	9/2000	Hwang et al.
D463,789 S	10/2002	DeKalb et al.
D469,753 S	2/2003	Andre et al.
6,574,345 B1	6/2003	Huang

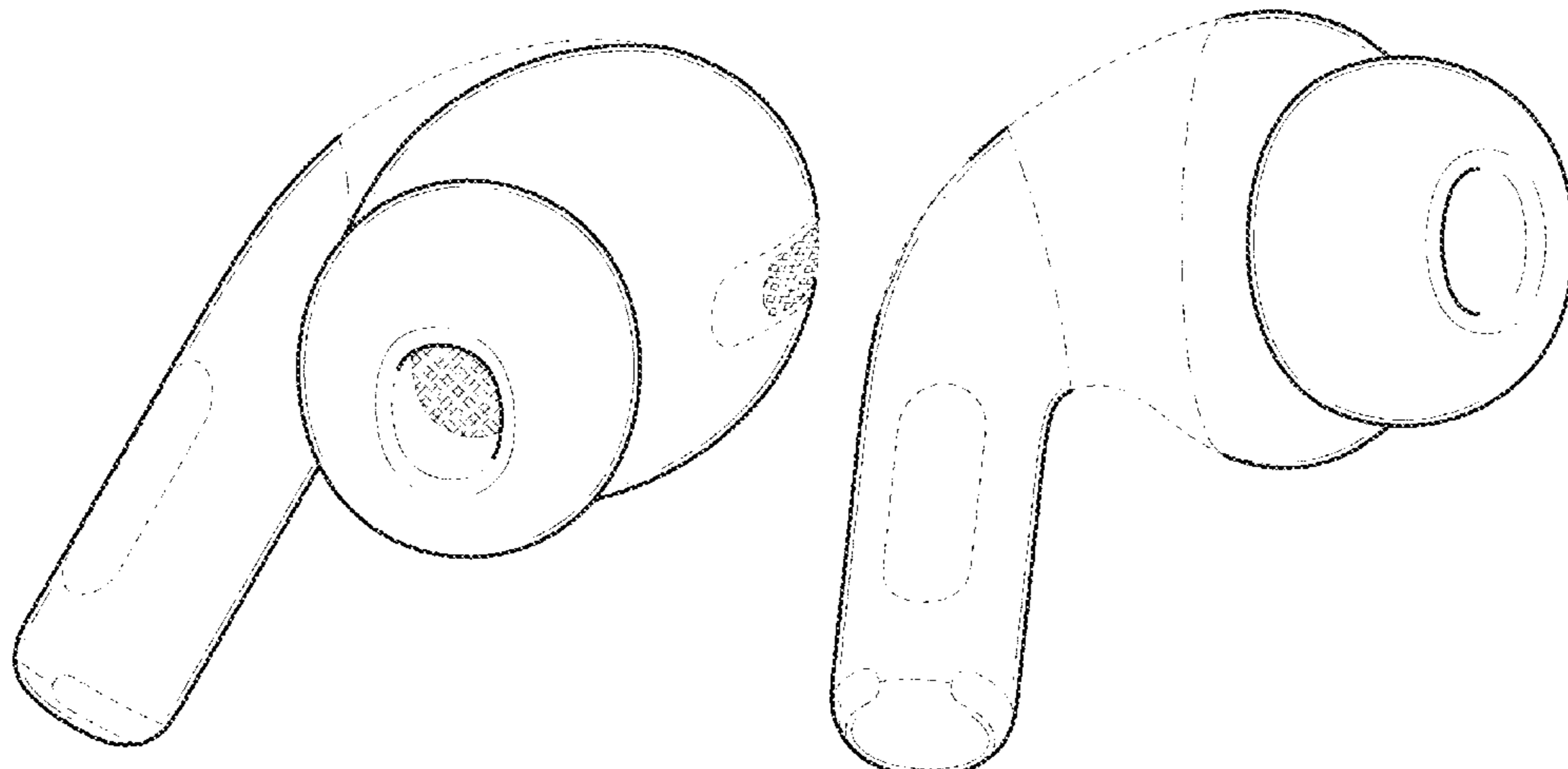

JP D1667778 8/2020
JP D1667780 8/2020
JP D1667781 8/2020
JP D1667782 8/2020
TW 219087-0001 * 11/2020

OTHER PUBLICATIONS

IBlink WLP3 Earbuds—100Hz-10kHz, Noise Isolation, 3.5mm Jack, LED Light (Pink), White, TigerDirect.com, http://www.tigerdirect.com/applications/SearchTools/item-details.asp?EdpNo=3988300&csid=_61, dated Jan. 31, 2013; 4 pages.
Japanese Patent Office Document HJ 21000610, dated Jul. 26, 2017.
Japanese Patent Office Document HJ 27054573, dated Jul. 26, 2017.
Philips SHE2650/37 In-Ear Earbuds with Twin Vents, ShoppingNexus.com, <http://www.shoppingnexus.com/electronics/pr/philips-she265037-in-ear-earbuds-with-twin-vents1.html>, dated Jan. 31, 2013; 1 page.

* cited by examiner

Primary Examiner — Paula Allen Greene
(74) *Attorney, Agent, or Firm* — Sterne, Kessler,
Goldstein & Fox P.L.L.C.

(57) **CLAIM**

The ornamental design for an earphone, as shown and described.

DESCRIPTION

FIG. 1 is a front perspective view of an earphone showing the claimed design;
FIG. 2 is a bottom perspective view thereof;
FIG. 3 is a front view thereof;
FIG. 4 is a rear view thereof;
FIG. 5 is a left side view thereof;
FIG. 6 is a right side view thereof;
FIG. 7 is a top view thereof; and,
FIG. 8 is a bottom view thereof.

The dashed broken lines in the figures show portions of the earphone that form no part of the claimed design.

The dot-dash broken lines in the figures show boundaries that form no part of the claimed design.

1 Claim, 4 Drawing Sheets

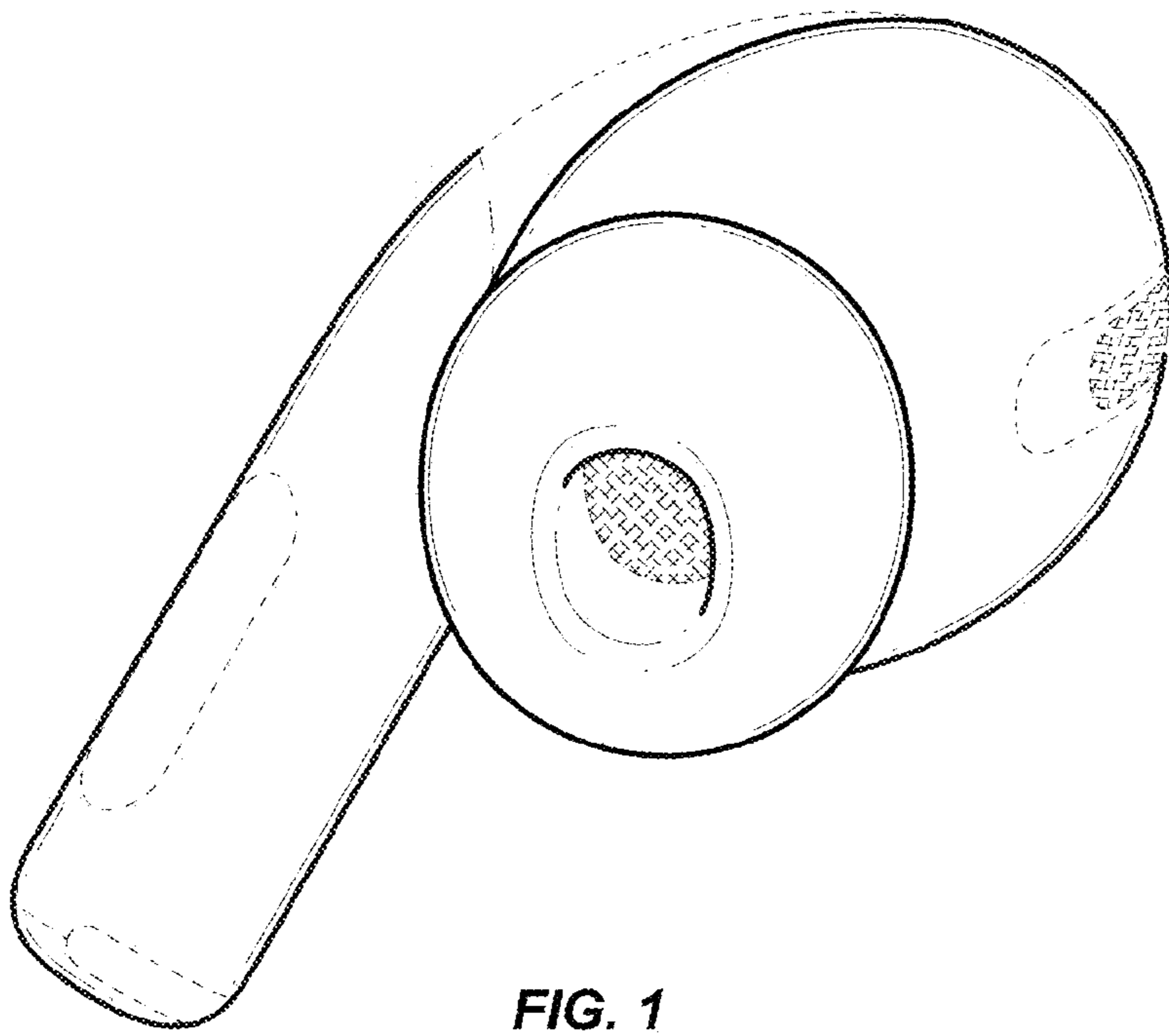

FIG. 1

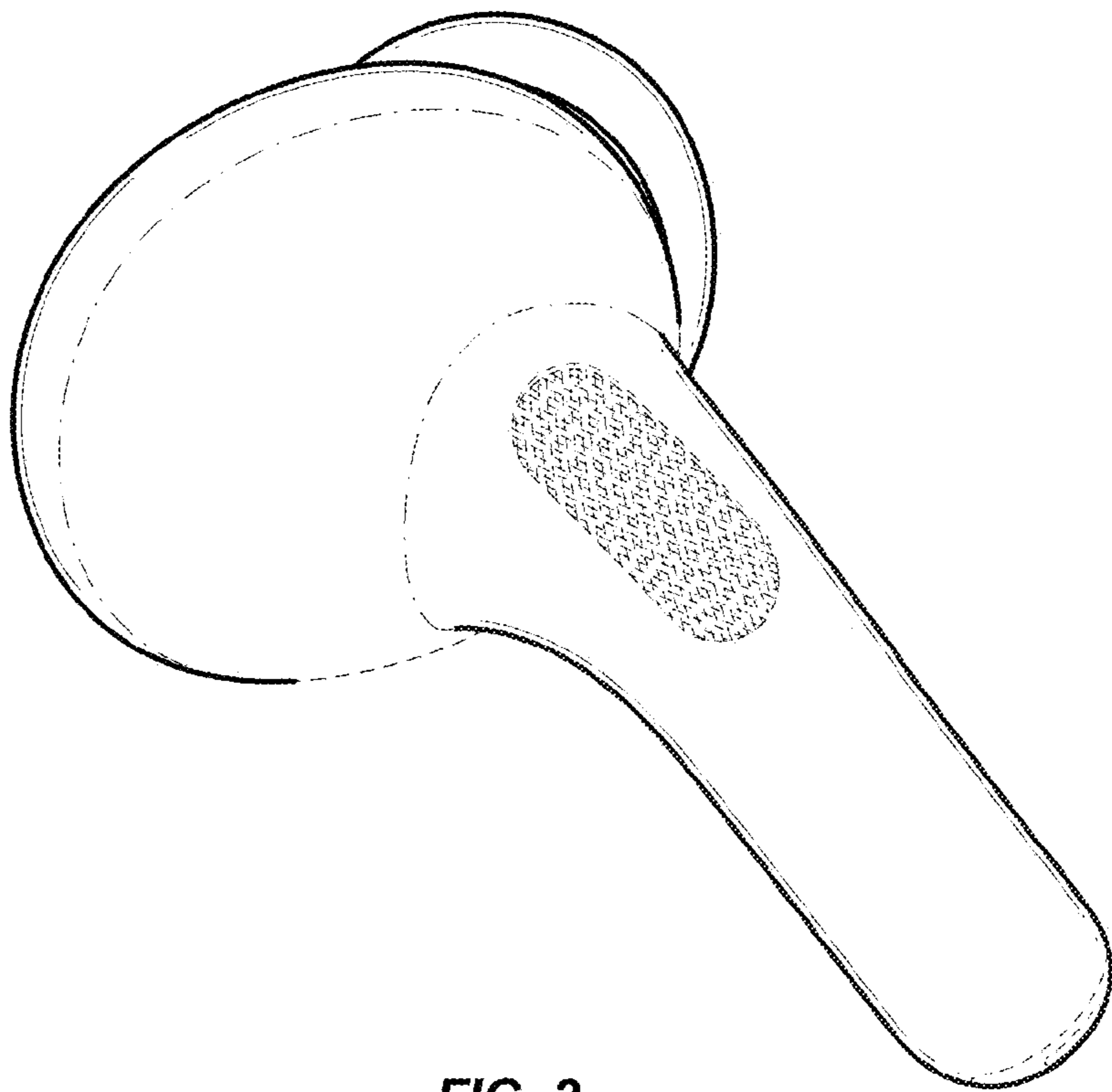

FIG. 2

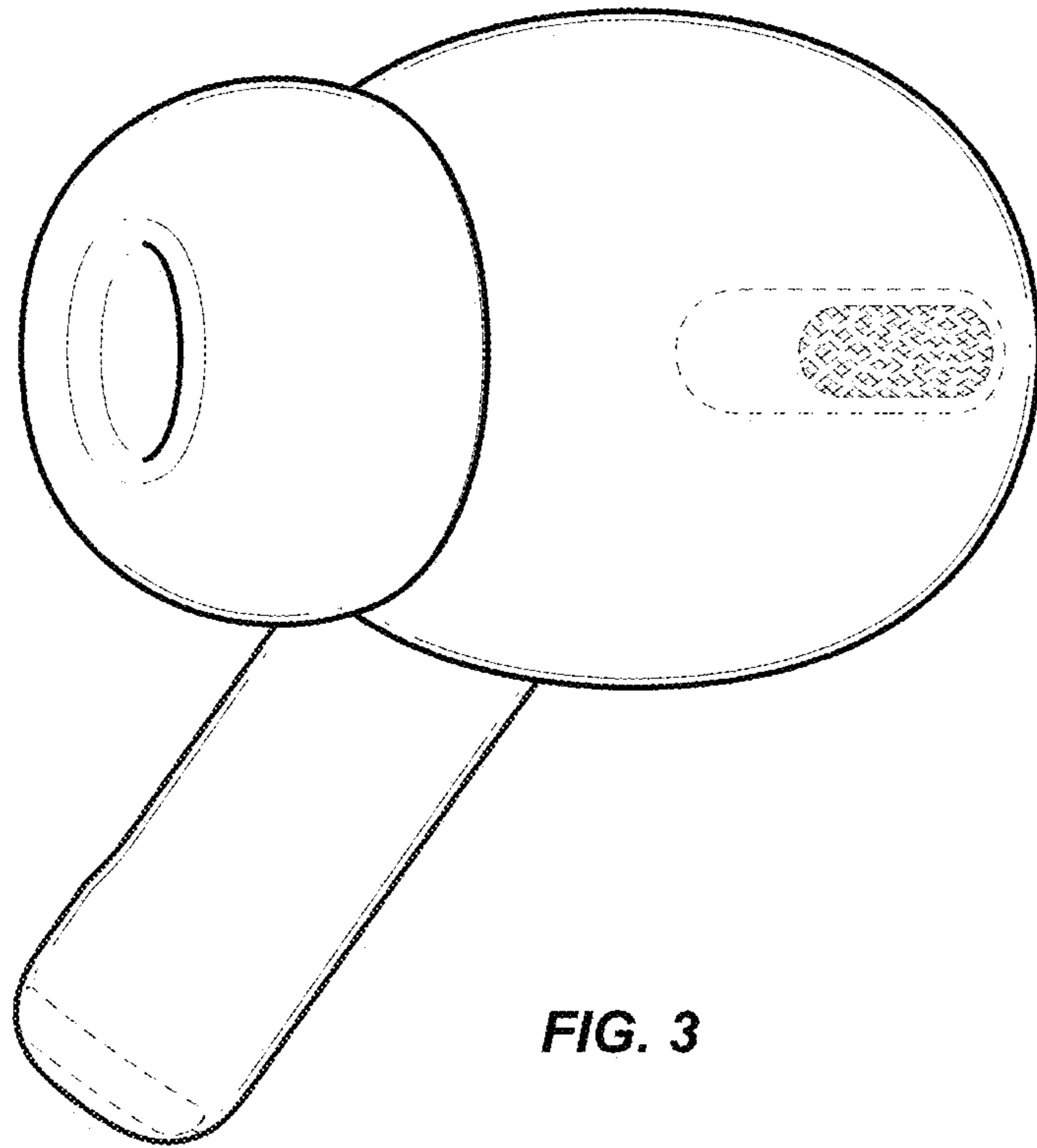

FIG. 3

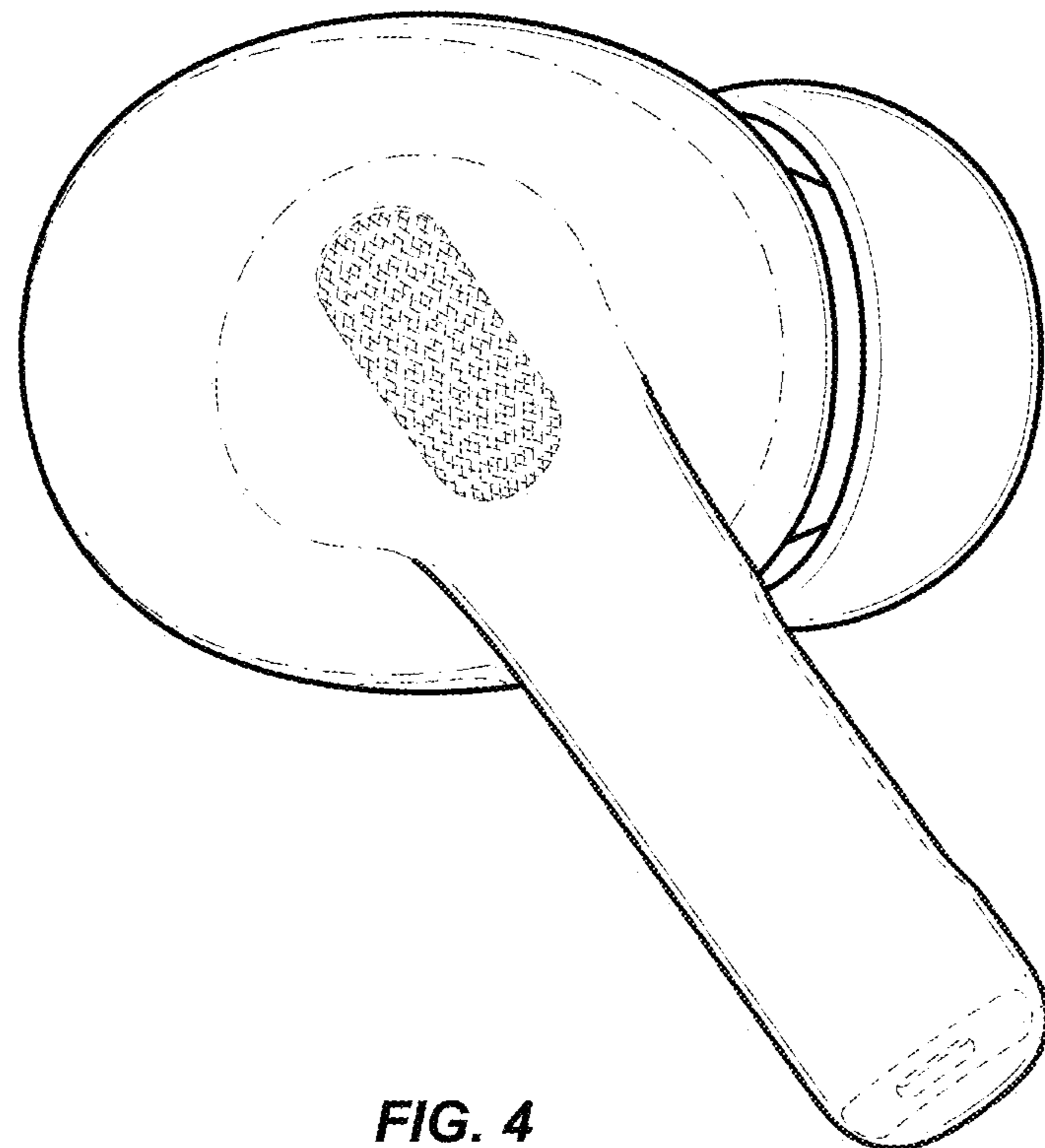

FIG. 4

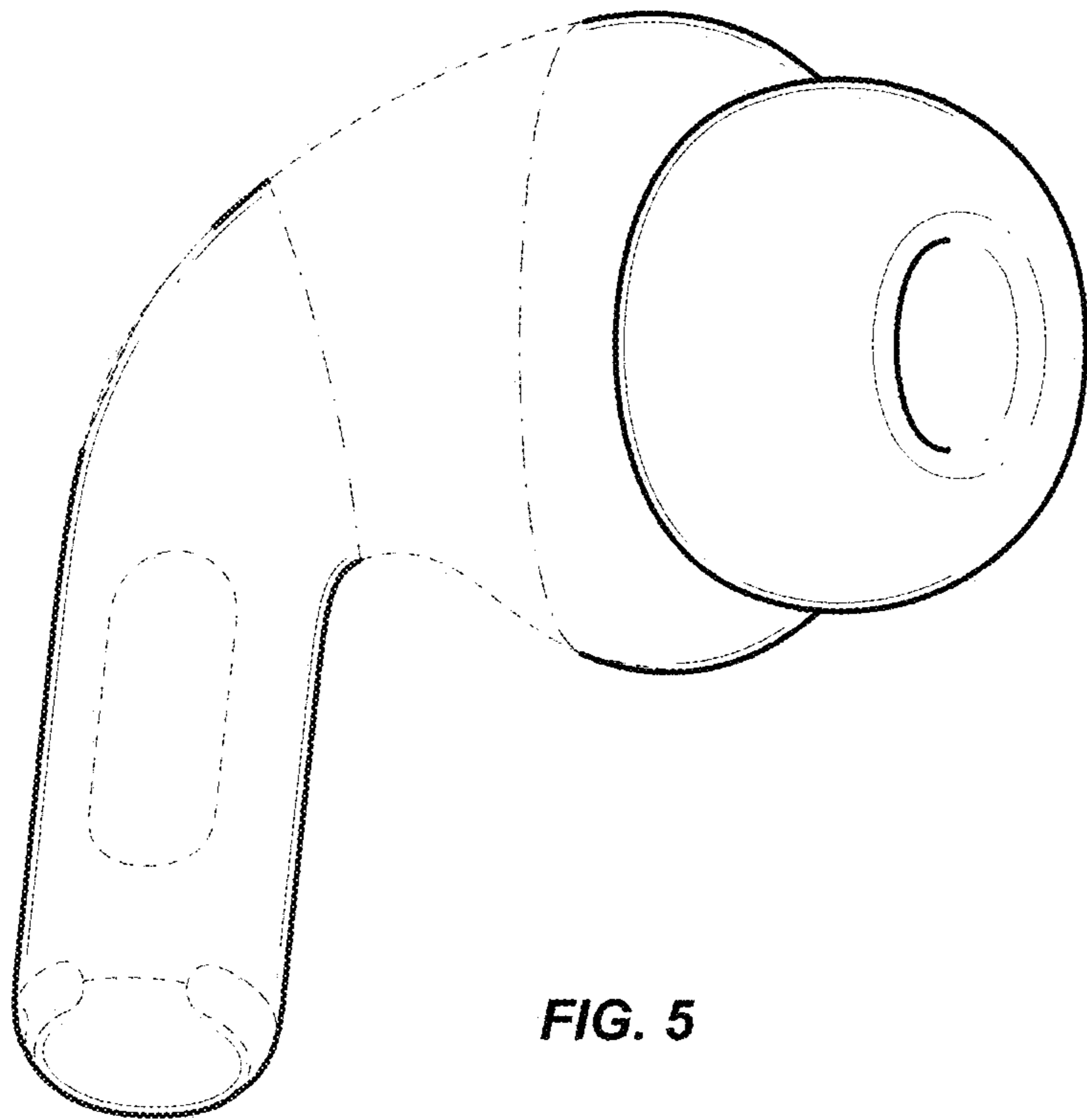

FIG. 5

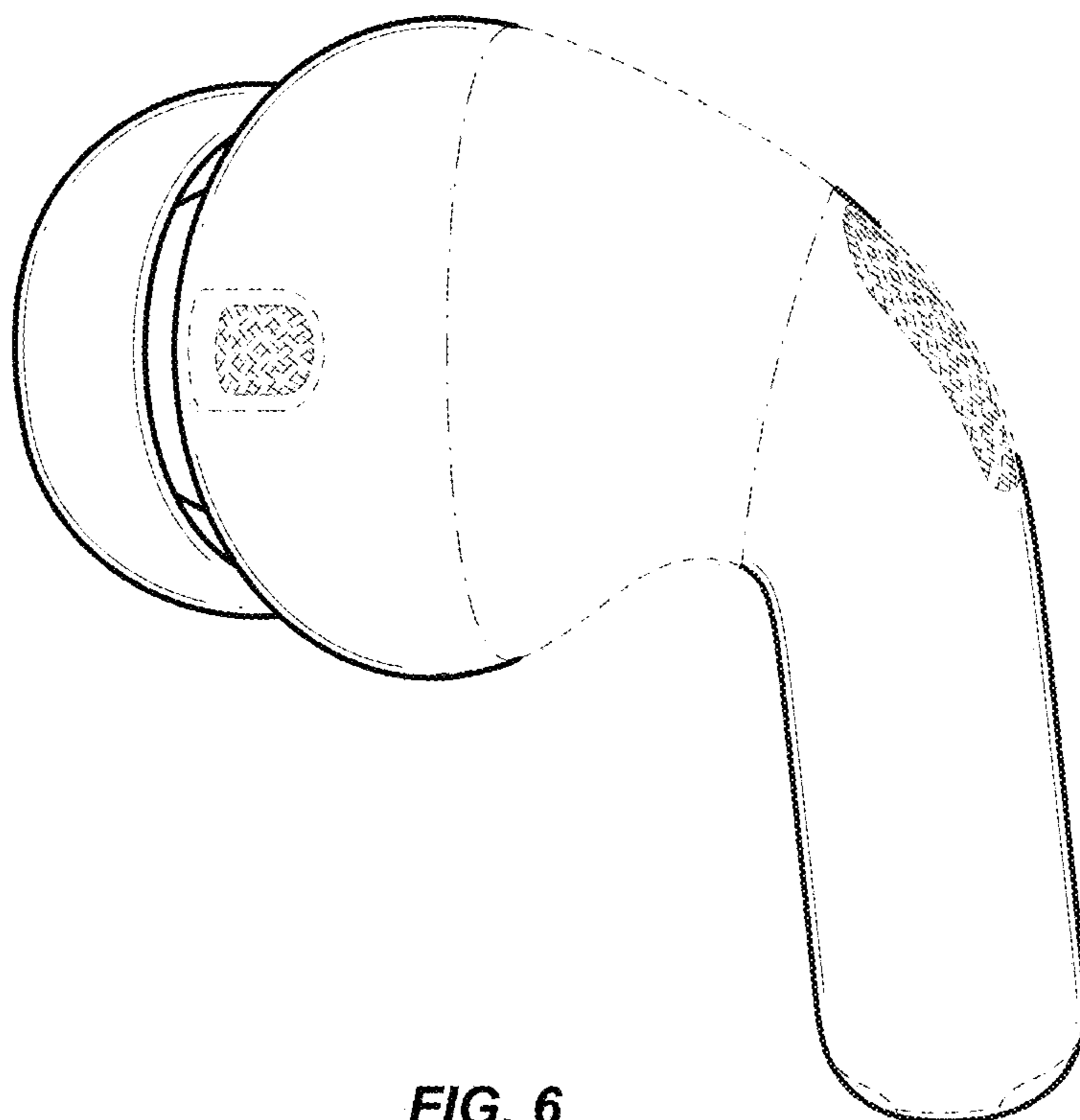

FIG. 6

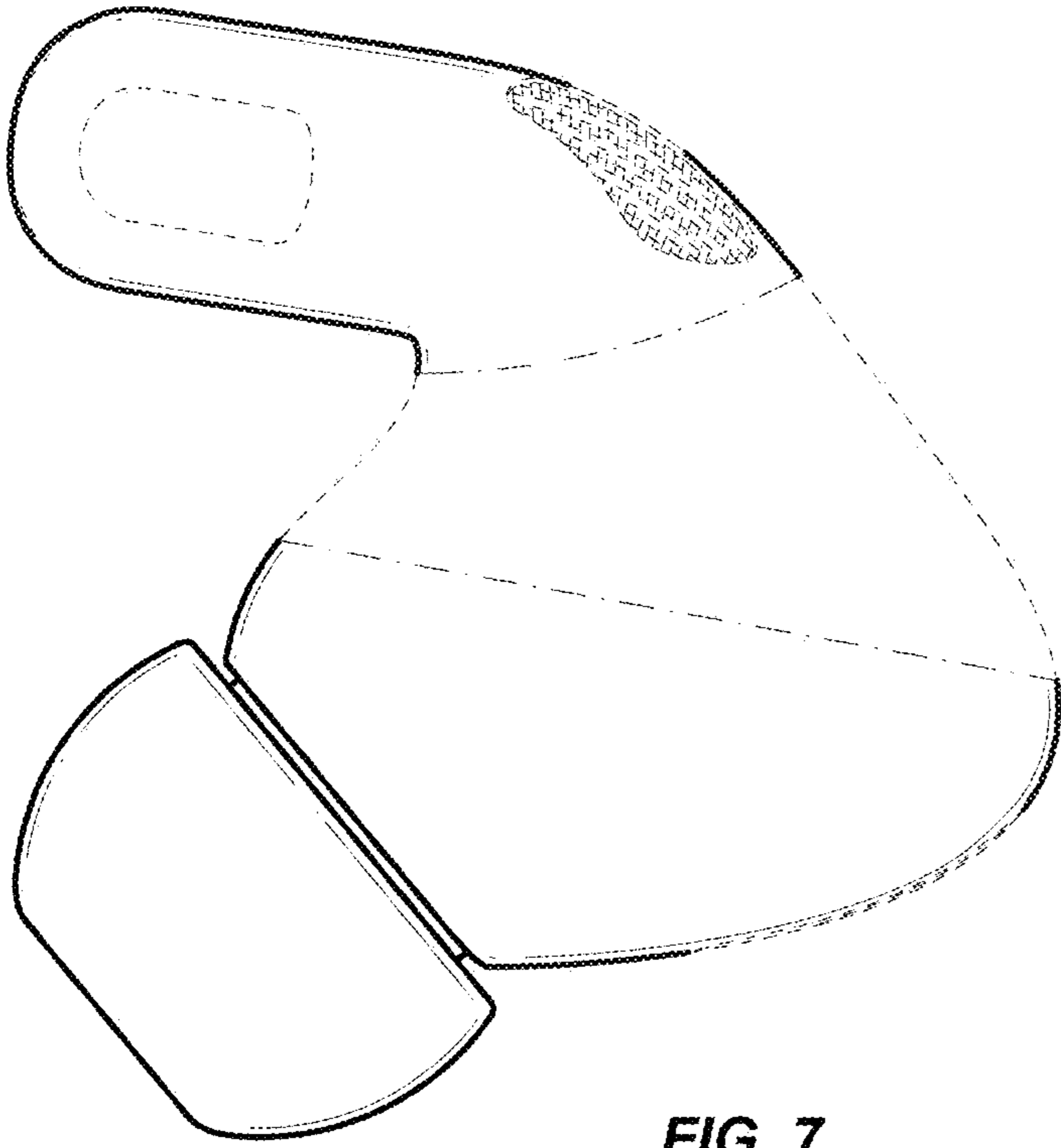

FIG. 7

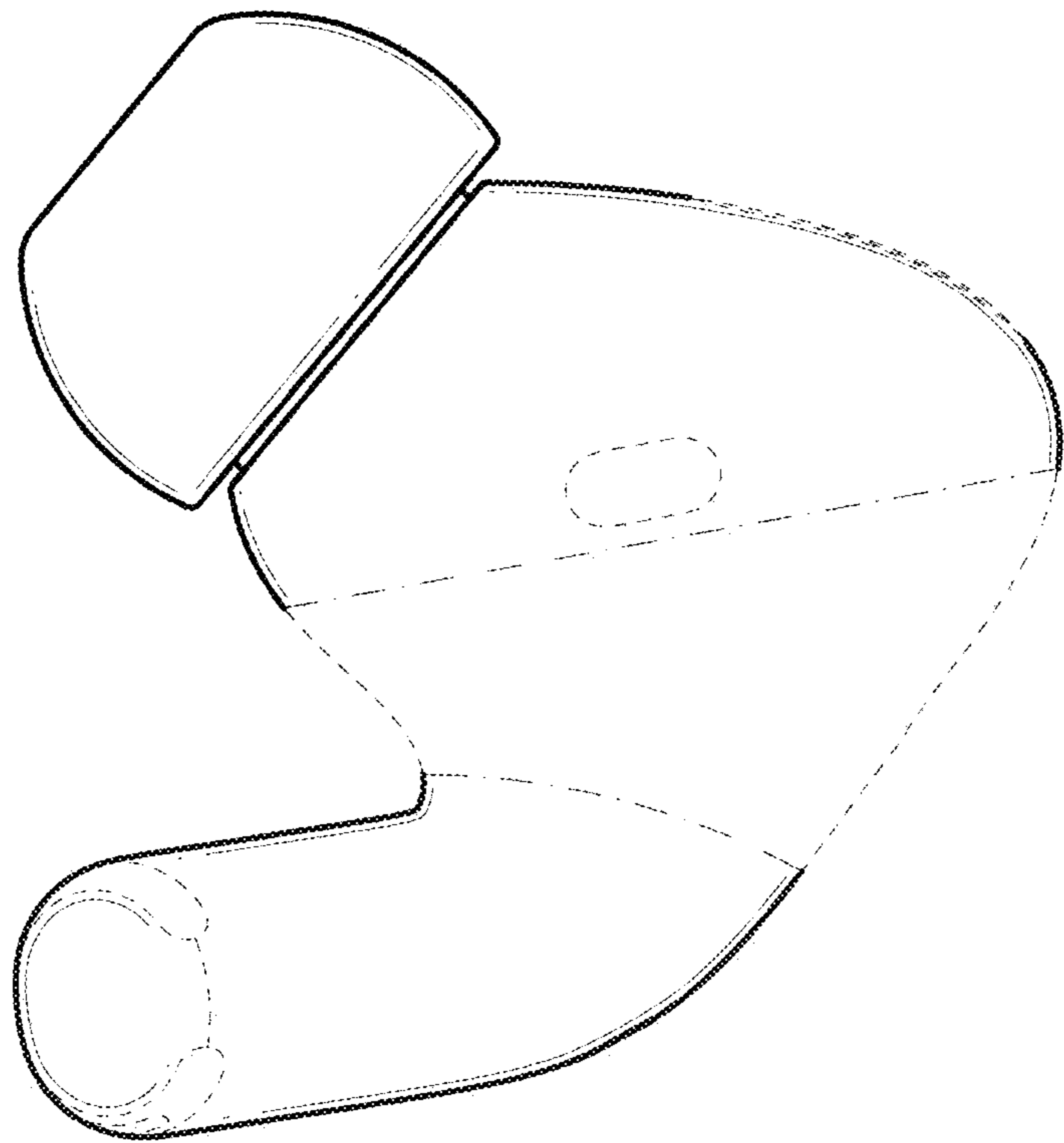

FIG. 8

UNITED STATES PATENT AND TRADEMARK OFFICE
CERTIFICATE OF CORRECTION

PATENT NO. : D975,066 S
APPLICATION NO. : 29/837465
DATED : January 10, 2023
INVENTOR(S) : Akana et al.

Page 1 of 1

It is certified that error appears in the above-identified patent and that said Letters Patent is hereby corrected as shown below:

On the Title Page

In the Related U.S. Application Data Item (63), replace:

“Continuation of application No. 29/805,722, filed on Aug. 30, 2021, now Pat. No. Des. 951,234, which is a continuation of application No. 29/768,810, filed on Feb. 1, 2021, now Pat. No. Des. 929,376, and a continuation of application No. 29/768,818, filed on Feb. 1, 2021, now Pat. No. Des. 929,972, and a continuation of application No. 29/706,556, filed on Sep. 20, 2019, now Pat. No. Des. 909,347, which is a continuation of application No. 29/706,556, filed on Sep. 20, 2019, now Pat. No. Des. 909,347.”

With:

--Continuation of application No. 29/805,722, filed on Aug. 30, 2021, now Pat. No. Des. 951,234, which is a continuation of application No. 29/768,810, filed on Feb. 1, 2021, now Pat. No. Des. 929,376, which is a continuation of application No. 29/706,556, filed on September 20, 2019, now Pat. No. D909,347. Said application No. 29/805,722 is a continuation of application No. 29/768,818, filed on February 1, 2021, now Pat. No. Des. 929,972, which is a continuation of application No. 29/706,556, filed on September 20, 2019, now Pat. No. Des. 909,347.--

Signed and Sealed this
Second Day of April, 2024
Katherine Kelly Vidal

Katherine Kelly Vidal
Director of the United States Patent and Trademark Office